

F-55

MAKING THE MOST OF
YOUR ELECTONE

YAMAHA ELECTONE™

F-55

AUTO ARPEGGIO (Page 13)

UPPER COMBINATION/ORCHESTRA (Page 4)

UPPER SPECIAL PRESETS (Page 5)

UPPER ENSEMBLE VOICES (Page 5)

UPPER/LOWER CUSTOM VOICES (Page 6)

ENSEMBLE (Page 3)

GENERAL PRESETS (Page 7)

LOWER COMBINATION/ORCHESTRA (Page 4)

LOWER SPECIAL PRESETS (Page 5)

LOWER ENSEMBLE VOICES (Page 5)

PEDAL CUSTOM VOICES
(Page 7)

MASTER VOLUME
(Page 2)



MANUAL BALANCE (Page 9)

AUTO RHYTHM (Page 10-11)

SYMPHONIC (Page 8)

TREMOLO (Page 8)

ORCHESTRA CELESTE (Page 8)

VIBRATO (Page 8)

TREMOLO SPEED (Page 8)

AUTO BASS CHORD (Page 14-15)

POWER
(Page 2)

REVERB
(Page 9)

SUSTAIN (Page 9)

KNEE LEVER (Page 9-12)

FOOT SWITCH (Page 9-11)

PLAY ASSIST (Page 12)

WELCOME TO THE MUSICAL WORLD OF YAMAHA

We are delighted to have you as a member of an ever increasing group of Yamaha Electone Owners. We are confident that your purchase of the F-55 Electone will mark the beginning of a lifelong partnership of musical creativity, relaxation and pleasure.

The Yamaha F-55 represents the very latest in technology. The combination of Digital and FM (Frequency Modulation) technologies has made it possible for Yamaha engineers to provide sounds of amazing clarity and authenticity as well as an interactive responsiveness between you the performer, and your new Electone. When you add these outstanding features to an advanced Memory system, the result you get is the FM (Frequency Modulation and Advanced Memory System) technology, the benchmark by which others will be measured.

The Yamaha design concepts of increased responsiveness to the polished performer's needs, and a reduced complexity for those having only a limited amount of time to invest, have reached new horizons in the F-55. So, whatever your level or skill may be, your Yamaha Electone stands ready to accommodate you. Please read this manual carefully in order that you may become familiar with the many unique features available to you. While every effort has been made to provide an instrument that is both responsive and easy to play, it is only through study and experimentation that you will be able to utilize your new Electone to its fullest potential.

NOTICE: This manual contains information vital to the proper installation, operation and maintenance of your Yamaha Electone. Many of the functions and effects incorporated in the F-55 are totally new, and several interact with each other.

Service charges incurred due to lack of knowledge relating to how a function or effect works (when the unit is operating as designed), are not covered by the manufacturer's warranty. Please study this manual carefully before requesting service.

CONTENTS

	<i>Page</i>
I. GETTING ACQUAINTED WITH YOUR ELECTONE	2
II. FEATURE BY FEATURE EXPLANATION	
• ENSEMBLE SECTION	3
ENSEMBLE	
• VOICE SECTIONS FOR UPPER AND LOWER KEYBOARDS	4
COMBINATION/ORCHESTRA, SPECIAL PRESETS, ENSEMBLE VOICES, CUSTOM VOICES	
• GENERAL PRESETS	7
• VOICE SECTION FOR PEDAL KEYBOARD	7
CUSTOM VOICES	
• EFFECTS AND CONTROLS	8
TREMOLO, SYMPHONIC, VIBRATO, SUSTAIN, REVERB, GLIDE, MANUAL BALANCE	
• AUTO RHYTHM UNIT	10
RHYTHM PATTERNS, RHYTHM CONTROLS, BREAK VARIATION, AUTO VARIATION, EXTRA PERCUSSION, FOOT SWITCH CONTROLS	
• AUTOMATIC FEATURES	12
PLAY ASSIST, AUTO ARPEGGIO, AUTO BASS CHORD	
III. USEFUL INFORMATION ABOUT THE ELECTONE	
• ACCESSORY JACKS AND SOCKETS	16
• ELECTROMAGNETIC INTERFERENCE	16
• INSTALLATION AND MAINTENANCE	17
• TROUBLESHOOTING	18
• SPECIFICATIONS	19
• FCC CERTIFICATION	20

I. GETTING ACQUAINTED WITH YOUR ELECTONE

We know that you're anxious to get started! But . . . Have you read the INSTALLATION AND MAINTENANCE sections? If not, this is the time to do so, and you can find those sections on Page 17.

Now that you've read the Installation and Maintenance sections, let's begin. If we seem to start from a point that seems overly "basic", please be patient. We will get to the study of individual effects and controls right after we satisfy your urge to play something . . . anything at all . . . just to reassure yourself that you are the master of this new purchase, and that you did select wisely.

First, a few basic controls must be identified.

- 1) The **POWER** switch located on your right must be on. Naturally, the A/C plug has to be plugged in, too!

The power indicator lamp will light up.

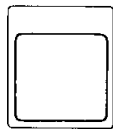

POWER

- 2) The **MASTER VOLUME** control should be turned clockwise to a position where the white mark is vertical. You may want to change this setting from time to time.

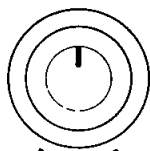

MASTER VOLUME

- 3) Your Electone has an **EXPRESSION PEDAL** which must be pushed down slightly in order that the music you're about to produce can be heard.

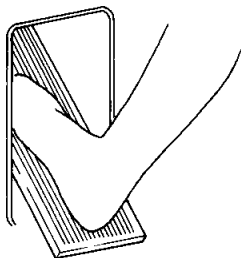

- 4) Now press one of the **GENERAL PRESETS** buttons.

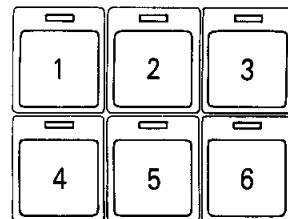

GENERAL PRESETS

- 5) Now, play something on the **Upper and Lower Keyboards**.

Push a different button and play a few measures. Try still another ... and continue until you've sampled all buttons at least once. (When you sample sounds from Pedal Keyboard, turn on one of the buttons in PEDALS section and move down the volume slider.) (refer to Page 7)

And, this is only the beginning!

Aren't you glad that you made the decision to purchase an FE Series Electone?

Now that you're sure that you're the boss...let's examine each of the controls and effects, one by one. But, make sure to turn off GENERAL PRESETS before you do so.

★ KEYING PRIORITIES

The following Keying Priorities and speaking capabilities are part of the design of your FE Series Electones.

Upper Keyboard and Lower Keyboard: A total of ten keys may be played at any one time. These ten keys are available in any Upper/Lower Keyboard ratio. For example, if you press eight keys on the Upper Keyboard, only two keys will produce sound on the Lower Keyboard.

★ Custom Voices are **MONOPHONIC**, meaning that only one note at a time can be played, and if more than one note is pressed, the Custom Voices will play the note farthest to the right.

Pedal Keyboard: The Pedal Keyboard is **MONOPHONIC** (meaning that only one note at a time can be played). When more than one pedal is pressed, the highest note (pedal farthest to the right) will be heard.

II. FEATURE BY FEATURE EXPLANATION

ENSEMBLE SECTION

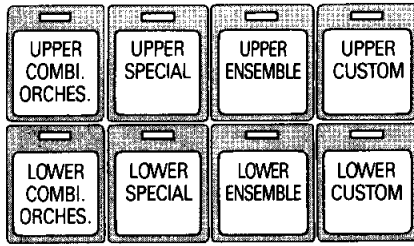

—ENSEMBLE—

[ENSEMBLE]

The ENSEMBLE section is extremely important, as it centrally controls the voice sections for the Upper and Lower Keyboards, making it easy to quickly change, add or blend instruments during a performance. Both the Upper and the Lower Keyboards have four voice sections available (COMBINATION/ORCHESTRA, SPECIAL PRESETS, ENSEMBLE VOICES, and CUSTOM VOICES), each with its own independent sliding volume control. The ENSEMBLE section allows you to instantly select or cancel any of the voices from the various Upper and Lower Keyboard voice sections.

As the diagram below illustrates, the upper row of selectors corresponds to the voice sections of the Upper Keyboard, while the lower row of selectors corresponds to the Lower Keyboard voice sections. In addition, the outline of each of the selectors in the ENSEMBLE section utilizes the same color as its corresponding voice selectors, making it easy for you to quickly locate any voice section on the control panel.

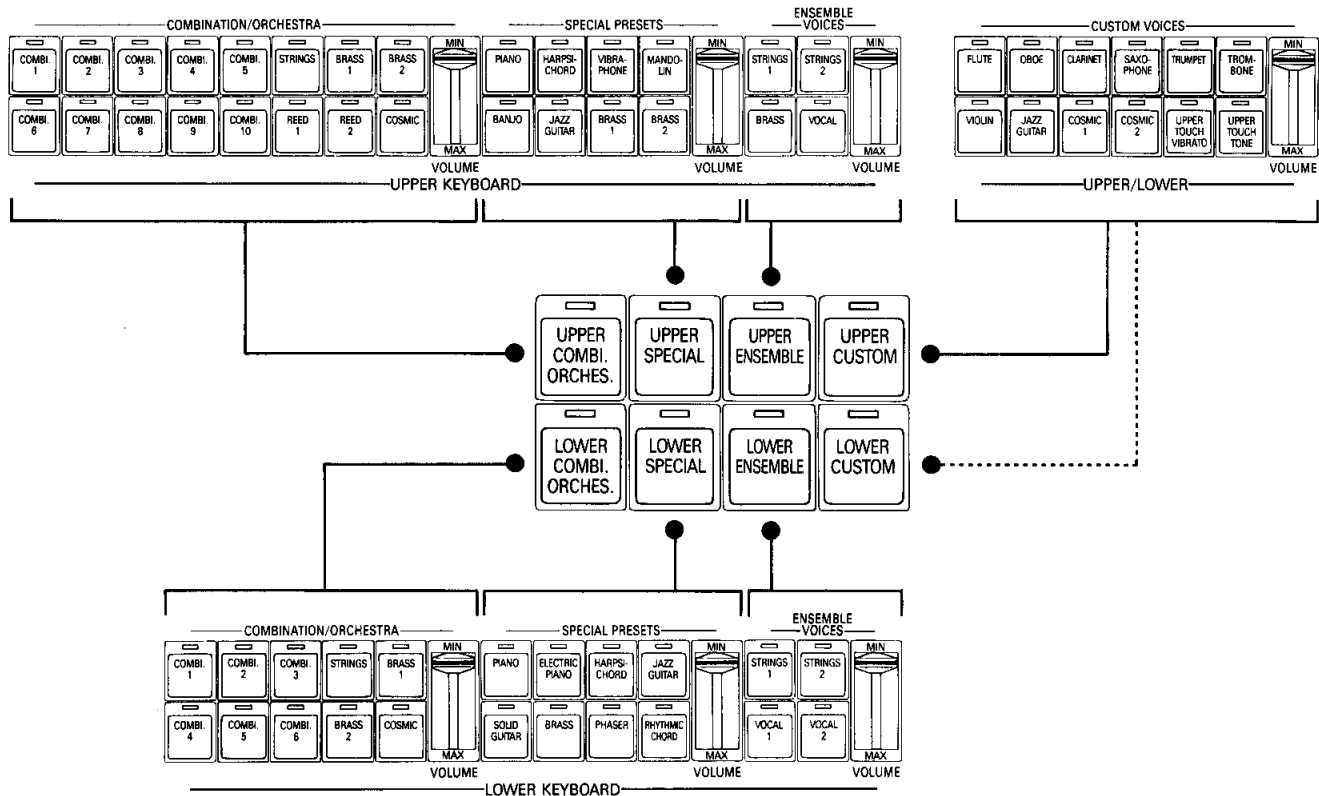

★ Custom Voices can be selected for use on either the Upper or the Lower Keyboard, but not on both simultaneously.

VOICE SECTIONS FOR UPPER AND LOWER KEYBOARDS

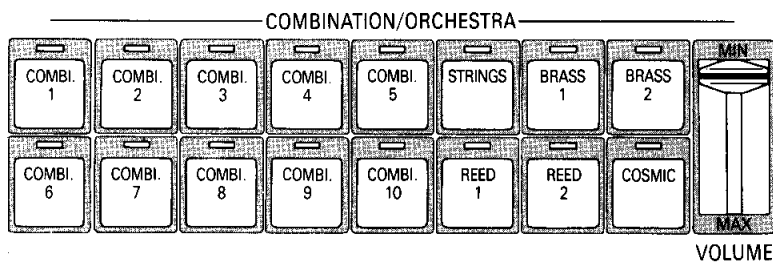

(UPPER)

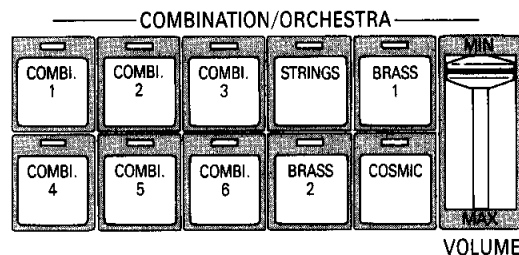

(LOWER)

[COMBINATION/ORCHESTRA]

In this section, (outlined in blue), you can produce two major types of voices, COMBINATION and ORCHESTRA. Various "organ" sounds are preset in COMBINATION, while the sounds of the major instrumental sections of an orchestra, including Strings, Brass and Reed, as well as specially-voiced COSMIC sound are preset in ORCHESTRA. To familiarize yourself with the operation of this section, please try the following example:

1) In the ENSEMBLE section, press the UPPER COMBI./ORCHES. button.

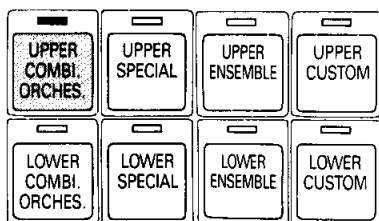

2) Select one of the instruments found in the UPPER COMBINATION/ORCHESTRA section.

3) Move the sliding volume control down.

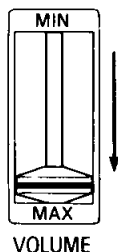

Now, when you press a note on the Upper Keyboard, you will hear the sound that you selected in step #2. To appreciate the tremendous versatility of your Electone, take this opportunity to listen to the remaining sounds in this section, as well as those found in the Lower Combination/Orchestra Section.

● Tones Preset in COMBINATION

[UPPER]

COMBI. 1	Organ sound
COMBI. 2	Flute sound
COMBI. 3	Flute coupler sound 1
COMBI. 4	Jazz organ sound 1
COMBI. 5	Church organ sound
COMBI. 6	Flute coupler sound 2
COMBI. 7	Organ coupler sound
COMBI. 8	Theatre organ sound
COMBI. 9	Jazz organ sound 2
COMBI. 10	Chime sound

[LOWER]

COMBI. 1	Organ sound
COMBI. 2	Flute sound
COMBI. 3	Flute coupler sound
COMBI. 4	String sound
COMBI. 5	Flute coupler sound 1
COMBI. 6	Flute coupler sound 2

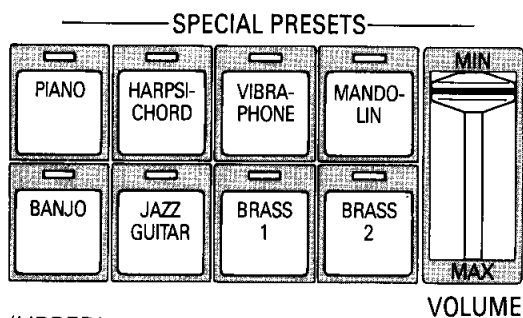

(UPPER)

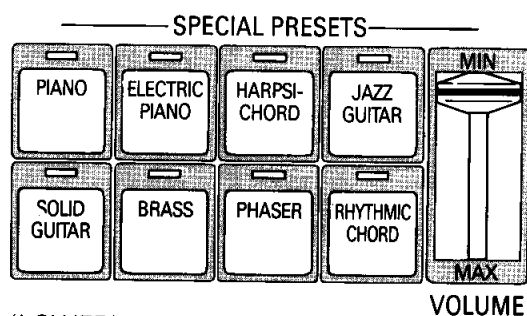

(LOWER)

[SPECIAL PRESETS]

These selectors (outlined in orange) are used to re-create some of the more percussive sounds of the orchestra, such as PIANO, HARPSICHORD, and VIBRAPHONE, as well as some specially-voiced BRASS sounds. Also, Lower Special Presets have the RHYTHMIC CHORD function to synchronize with the rhythm. In order to familiarize yourself with the operation of this section, please take a few moments to try the following example:

- 1) In the ENSEMBLE section, press the UPPER SPECIAL button.
- 2) Select one of the instruments found in the UPPER SPECIAL PRESETS section.
- 3) Move the sliding volume control down.

When you press a key on the Upper keyboard, you will now hear the sound that you selected in Step #2. To appreciate the tremendous versatility of your Electone, take this opportunity to listen to the remaining sounds in this section, as well as those found in the Lower Special Presets section.

● PHASER (LOWER)

This effect, when added to the Lower Special Presets voices, is similar to the effect produced by a guitar player using a wah pedal or a trumpet player rapidly inserting and removing a mute.

● RHYTHMIC CHORD (LOWER)

When you turn on the RHYTHMIC CHORD button, voices of the Lower Special presets will automatically be effected in synchronization with the rhythm.

This function produces an instrumental accompaniment (in addition to the rhythm instruments) that accentuates the rhythmic pattern to enhance your Lower Keyboard playing. Simply stated, RHYTHMIC CHORD takes the Lower Keyboard notes and "animates" them (makes them active) in a rhythmic style which is complimentary to the rest of the rhythmic accompaniment. It can be used either independent of, or in conjunction with, the Auto Bass Chord section.

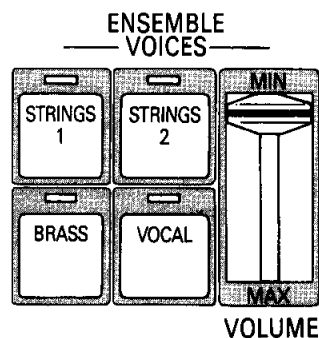

(UPPER)

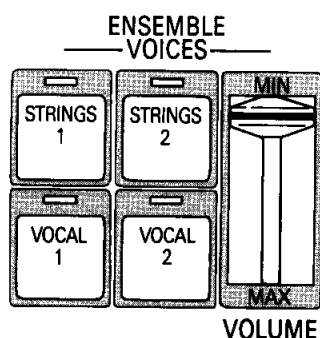

(LOWER)

[ENSEMBLE VOICES]

The Ensemble Voices, (outline in blue-green), not to be confused with the Ensemble Section (which centrally controls the various voice sections on the upper and lower keyboards), instantly provides the sounds of a String Ensemble and Vocal Ensemble (choir), and also includes a Brass Ensemble.

- 1) In the ENSEMBLE section, press the UPPER ENSEMBLE button.
- 2) Select one of UPPER ENSEMBLE VOICES buttons.
- 3) Move the sliding volume control down.

When you press a key on the Upper Keyboard, you will hear the sound that you selected in step #2. To appreciate the tremendous versatility of your Electone, take this opportunity to listen to the remaining sounds in this section, as well as those found in the Lower Ensemble Section.

★ Although the Symphonic effect is already preset in Ensemble Voices, the speed of the effect can be varied with the SYMPHONIC and CELESTE buttons in the SYMPHONIC section.

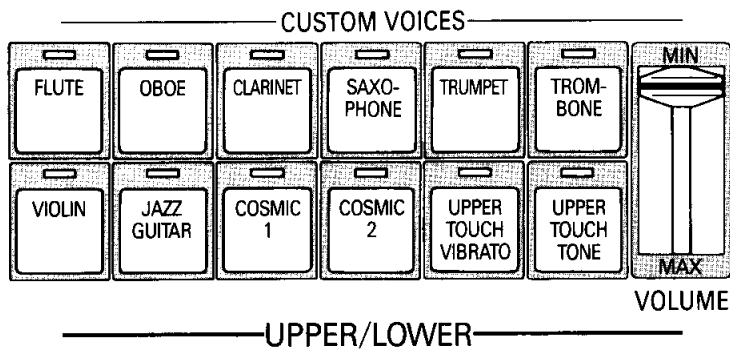

[CUSTOM VOICES]

These selectors (outlined in gold) are used to re-create several known solo instruments, as well as several "innovative" sounds (called COSMIC) most often associated with electronic synthesizers. FM technology, used on all voices in this section, enables the amazing authenticity which you are soon to experience. Since these are solo instruments, only one note may be played at any given time. To familiarize yourself with the operation of this section, please try the following example:

- 1) In the **ENSEMBLE SECTION**, press the **UPPER CUSTOM** button.

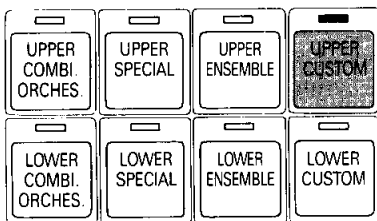

You have a choice of using either the Upper or Lower Keyboard (but not both simultaneously) for producing the **UPPER/LOWER CUSTOM VOICES**.

- 2) Select one of the instruments found in the **UPPER/LOWER CUSTOM VOICES** Section.
- 3) Move the sliding volume control down.

When you press a note on the Upper Keyboard, you will now hear the sound that you selected in Step #2. To appreciate the tremendous versatility of your Electone, take this opportunity to listen to the remaining sounds in this section.

- ★ With the **CUSTOM VOICES**, only one note at a time can be played, and when more than one note is pressed, the **CUSTOM VOICES** will automatically play the note farthest to the right.

● UPPER TOUCH VIBRATO



Vibrato can be used on all voice sections on your new Electone. For more information, please turn to page 8 where this feature is explained.

As an added feature, vibrato may be isolated from the rest of the instrument, for use by the Custom Voices section only, by selecting the Custom Only button in the Vibrato Section. Further, when using vibrato on the Upper Custom Voices, vibrato may be obtained by varying your finger pressure on the keys. To operate, simply press the Vibrato button, and when you wish to add the vibrato effect, exert further downward pressure on the keys of the Upper Keyboard. The vibrato can be proportionately increased and decreased by increasing or decreasing the downward pressure.

● UPPER TOUCH TONE



To allow the performer the ultimate in musical expression YAMAHA proudly introduces "TOUCH TONE." This feature converts the Upper Keyboard from "static" to "active" status, responding to each and every nuance in your touch as never before. In this way, the keyboard itself plays an active role in the texturing of sounds. While at first it may seem confusing and, perhaps difficult to become accustomed to, in a relatively short time you will appreciate the benefits derived from having this increased responsiveness and additional control.

After Touch Control (Pressure Sensitive) causes a change in volume and timbre (tone) when, after striking the keys, you exert further downward (not lateral) pressure on them.

NOTE: The degree of change differs from voice to voice.



GENERAL PRESETS

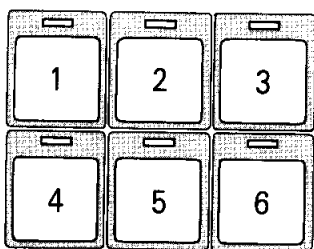

GENERAL PRESETS

Up until now, we have explored each of the voice sections of the Upper and Lower Keyboards individually. It is now time for us to explore the resources of the General Presets section, which allows you to instantly change the sounds of the Upper and Lower Keyboards by merely pressing one of the buttons, allowing the ultimate in ease of operation. Many sounds have been set for you in this section at our factory, and the following table describes each of these sounds:

● Sounds Preset in Each Button

1	Big Jazz Band
2	Pops Orchestra (Strings and Harpsichord)
3	Church Organ
4	Theatre Organ
5	Contemporary (Synthesizer)
6	String Ensemble

Note 1: The GENERAL PRESETS take precedence over the Upper and Lower Voices and volumes set on the control panel. Take note, however, that the actual sound obtained from the GENERAL PRESETS is not the setting that you will see on the panel. When you wish to obtain the sound set on the panel, simply turn off the GENERAL PERSETS button until all the lights in that section are off.

Note 2: The GENERAL PRESETS set only the sounds of the Upper and Lower Keyboards. Therefore, you must select a pedal sound and any other effect that you wish (Auto Rhythm, Auto Arpeggio, Play Assist, etc.).

VOICE SECTION FOR PEDAL KEYBOARD

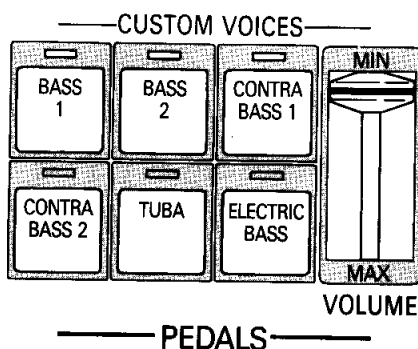

[CUSTOM VOICES]

The pedal keyboard of your Yamaha Electone F-55 provides most of the realistic bass sounds, thanks to FM Technology.

These selectors (outlined in gold) offer you two types of "organ-type" bass sounds as well as CONTRA BASS, ELECTRIC BASS, and TUBA. To obtain these sounds, merely press one of the voice selectors and move the VOLUME slider downward.

EFFECTS AND CONTROLS

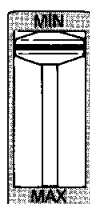
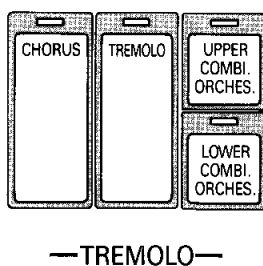
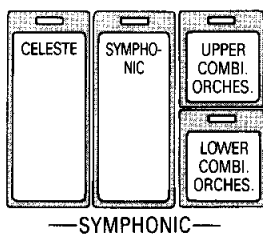

ORCHESTRA CELESTE

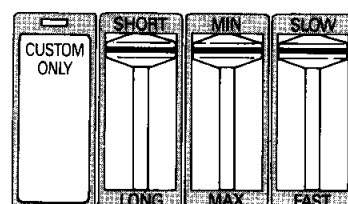

—VIBRATO—

[SYMPHONIC]

This feature, when applied to any voice, produces a “symphony-like” effect. It can be applied to the COMBINATION/ORCHESTRA section of either or both the Upper and Lower Keyboard.

Your YAMAHA F-55 creates this effect electronically by dividing the sounds that you assign to the SYMPHONIC (fast) or CELESTE (slow) speed into several separate channels. These individual channels are “delayed” (shifted in phase), then re-combined to produce the impression that a large number of instruments are involved.

[TREMOLO]

TREMOLO is a cycle variation in the amplitude (volume) of a sound. The Electone F-55, representing the very latest in technology, has eliminated the need for motors, belts and moving parts, and generates this effect electronically. The TREMOLO effect can be applied only to the UPPER and LOWER COMBINATION/ORCHESTRA Sections. To add this effect to either or both of these sections, first press the control(s) for that section and the corresponding indicator lamp will illuminate. Then select the desired speed: CHORUS (a slow speed), TREMOLO (a fast speed).

● TREMOLO SPEED

This control is provided so that you may adjust the TREMOLO (fast) speed to suit your personal taste. Use this control when the TREMOLO (not CHORUS) button is on. Turning this control clockwise will increase the speed of the tremolo effect. To slow down this effect, merely turn this control counter-clockwise.



TREMOLO SPEED

IMPORTANT: The TREMOLO and SYMPHONIC effects are electronically interlocked and cannot be used simultaneously by the same Voice Section. In the event that both the TREMOLO and SYMPHONIC effects are used by the same voice section, the SYMPHONIC effect will take precedence. For example, if the UPPER COMBI. ORCHES. button is on in both the SYMPHONIC and TREMOLO sections, only the SYMPHONIC effect will be obtained.

[ORCHESTRA CELESTE]

This feature enhances the UPPER and LOWER COMBINATION/ORCHESTRA sections, by “expanding” the sound. The voices of the F-55 are created from two sound sources, and the ORCHESTRA CELESTE effect gives you the impression that more than one instrument of the same type is being played, by slightly changing the pitches of the two sound sources. As you pull the slider toward you (toward maximum position), the difference between the two pitches will be increased.

- ★ The ORCHESTRA CELESTE effect can only be used with the voices in the COMBINATION/ORCHESTRA section. However, some sounds in the ENSEMBLE VOICES section already have this effect programmed into them.
- ★ This effect cannot be achieved on some ORCHESTRA voices.

[VIBRATO]

VIBRATO is a variation in pitch...a fluctuation above and below whatever note is being pressed. The VIBRATO DEPTH control regulates **how far** above and **below** the given pitch, while the VIBRATO SPEED control regulates **how fast** this fluctuation takes place. When imitating a soloist, it is often desirable to allow the pitch to remain constant for a short time and **then** to add the vibrato effect. This effect can be automatically produced for you by using the VIBRATO DELAY control, which regulates the amount of time it takes for the Vibrato to be activated after the note is pressed.

- ★ The Vibrato won't be activated by only setting DELAY or SPEED. Be sure to set the slider of DEPTH at first, and then set DELAY and SPEED.
- ★ In the Special Presets section, the Vibrato is not available. In addition, for the most realistic sounds possible, Vibrato is not available for the Pedal Keyboard or the Auto Arpeggio Voices.

● CUSTOM ONLY

When this button is depressed, (light illuminated), the vibrato will affect **only** the voices of the UPPER/LOWER CUSTOM VOICES, further enhancing your melody playing. The DEPTH, DELAY, and SPEED controls will function exactly as described above.

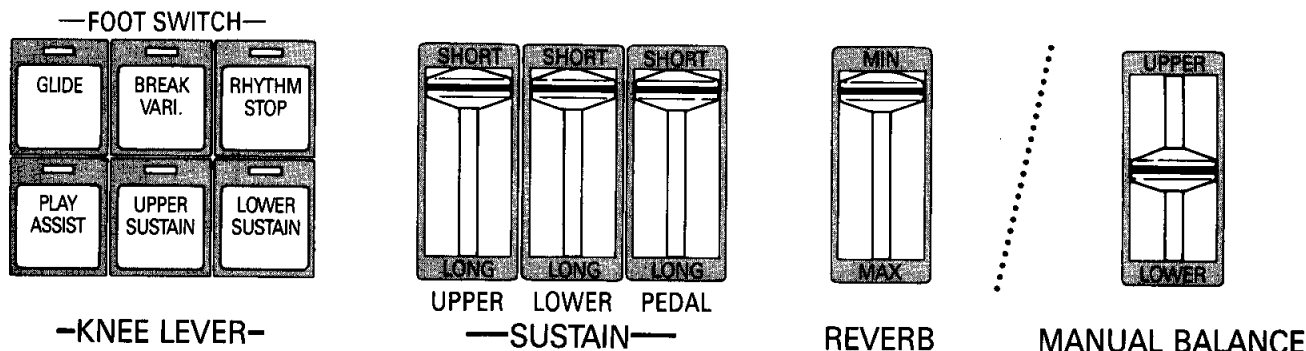

[SUSTAIN]

The SUSTAIN function allows a gradual fade-out of sound after the keys have been released. It can be utilized with any voice on either the Upper, Lower or Pedal Keyboard (or any combination of the three), and is controlled by using the two buttons and three variable sliding controls.

Try the following example to become familiar with the operation of this function.

- 1) Choose one keyboard to which you would like to add sustain, and select the corresponding button: UPPER SUSTAIN, LOWER SUSTAIN (These two buttons can also be used simultaneously).

NOTE: The SUSTAIN effect cannot be added to the UPPER/LOWER CUSTOM VOICES.

- 2) By using the appropriate slider control, adjust the amount of SUSTAIN desired.

Sustain effect for the Combination tones

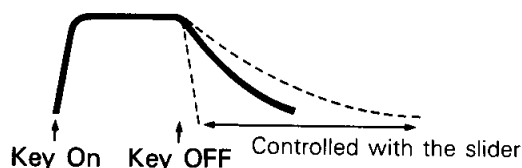

When the slider is in the MIN position, the SUSTAIN is completely off. As the control is pulled toward you, the amount of SUSTAIN is gradually increased.

●KNEE LEVER CONTROL

The Knee Lever (located beneath the keyboards) can be used to turn the SUSTAIN function for the Upper and Lower Keyboards (not Pedal) "ON" or "OFF". To operate, press either or both the UPPER SUSTAIN and/or LOWER SUSTAIN button(s), adjust the sliders to your taste, and move the Knee Lever to the right. Hold the lever in this position for as long as you desire SUSTAIN, and release the lever when you want to turn it off.

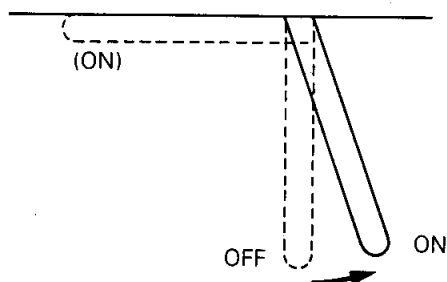

[REVERB]

Abbreviation for "Reverberation," "REVERB" is somewhat like "echo" involving the reflection (bouncing back) of sound. Since the "REVERB" sounds are not direct and not exact reflections of the original sounds, a very unique type of tone coloration is generated when they are mixed with the original sounds.

The REVERB control is continuously variable, and its intensity increases as it is pulled forward. A slightly different amount of REVERB may be required, depending on the environment and the types of music being played. Please remember that the REVERB effect modifies the sound of the Upper and Lower Keyboard's voices. Experiment with this control, using various instruments, and playing styles to find those settings that are most pleasing to you.

[GLIDE]

This effect permits the performer to lower the pitch of all voice sections associated with the Upper and Lower Keyboards by approximately 1/2 step. (It does not affect the Pedal.) In addition to the lowering of the pitch, the GLIDE effect also interrupts the VIBRATO effect.

You can add the GLIDE effect by using the Foot Switch located on the left side of the Expression Pedal. With the Foot Switch pressed to the left, the pitch will be lowered.. When the Foot Switch is released, the pitch (and the VIBRATO, if in use) will return to normal.

This effect is particularly useful in the simulation of acoustic instruments, that are customarily played using a glide effect...such as a trombone, guitar, and violin.

[MANUAL BALANCE]

This variable control (located on the panel to the left of the Upper Keyboard) is helpful when you want to adjust the relative balance between the volume of the Upper and Lower Keyboards without changing your registration. Simply adjust the control to indicate which keyboard you would like to be the loudest. The volume for the Upper Keyboard increases when it is moved toward the UPPER position, while the volume for the Lower Keyboard increases when it is moved toward the LOWER position.

AUTO RHYTHM UNIT

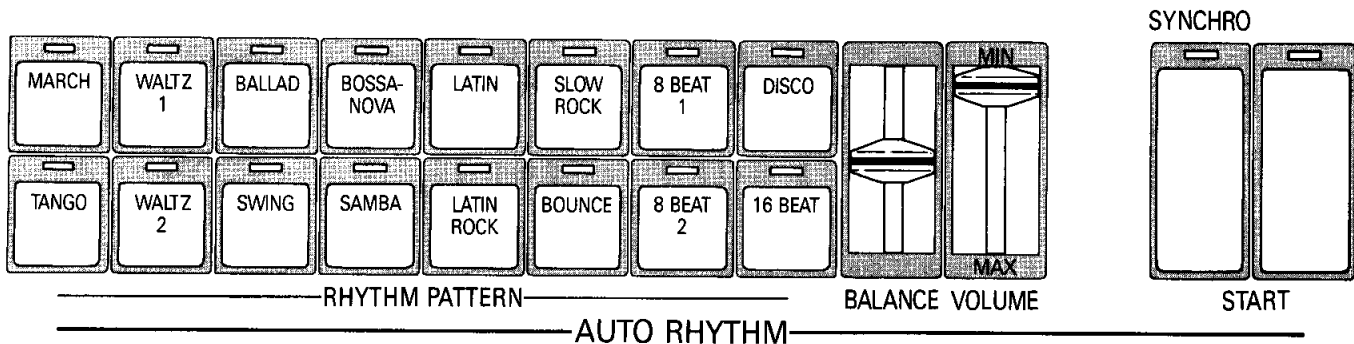

[RHYTHM PATTERNS]

The Auto Rhythm Unit of your Electone features a variety of very authentic percussion sounds. These sounds are actually recorded instruments stored digitally using a process called Full Wave Memory (FWM). These percussion instrument memories are then combined to form 16 basic RHYTHM PATTERNS (or styles).

Follow the simple step-by-step procedure outlined below, which describes the operation of your Auto Rhythm Unit.

1) Select and press one of the 16 Rhythm Patterns.

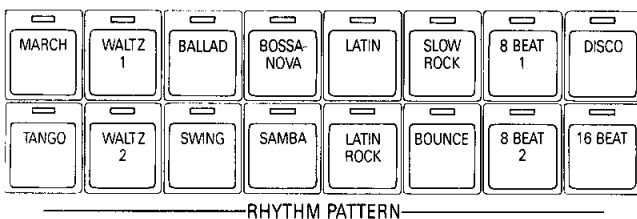

- 2) Pull the sliding VOLUME control toward you.
- 3) Press the START button on the right.

Subsequently, the Rhythm selected in step # 1 above will begin. Take this opportunity to listen to the other possibilities.

★ These 16 Rhythm patterns can also be combined, by pressing any two buttons in either the top or bottom row, simultaneously. (Rhythms in the top row cannot be combined with rhythms in the bottom row.)

[RHYTHM CONTROLS]

● START and SYNCHRO START

There are two ways to activate your Auto Rhythm Unit. When the START button is turned on, the rhythm will begin immediately, from the first beat. When using SYNCHRO START (left selector), the rhythm will wait for you to press either a Lower Keyboard or Pedal note, and then it will begin from the first beat. This feature allows the rhythm to be synchronized with you . . . starting only when you do.

● TEMPO CONTROL

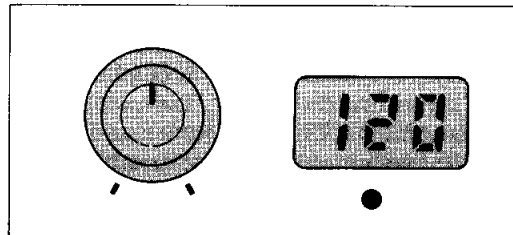

The detent-type rotary TEMPO control is used to regulate the speed of the Auto Rhythm Unit. To increase the speed, turn it clockwise. To decrease the speed, turn the control counter clockwise. The Digital Display will numerically indicate the exact tempo of the Auto Rhythm Unit (in number of beats per minute) at any given time.

At the beginning of some printed music, you might note an indication similar to the following:

M. M. ♩ = 120

This is called a "Metronome Marking" and it indicates the suggested tempo for that selection: in this case, 120 beats per minute. Simply set the rhythm tempo to this setting (or as close as possible). Naturally, you may vary from this suggested speed, and most probably will, especially when learning a song for the first time.

● DOWNBEAT INDICATOR LAMP

Below the numbers in the Digital Display window, you will find the Downbeat Indicator Lamp, which, once the rhythm has been activated, will flash at the first beat (downbeat) of each measure. In addition, when SYNCHRO START is in use, that lamp will act as a silent visual metronome, indicating the exact tempo until the rhythm is started. This feature, in addition to the Digital Display (explained below), enables you to get a good idea of the rhythm speed without having to produce any sound.

● BALANCE CONTROL

This control allows you to adjust the relative balance between the different percussion (rhythm) instruments to suit your particular taste. The central position approximates the optimum levels found in live performances. The BALANCE control permits a considerable amount of change in volume of several of the percussion instruments, tailoring the sounds to the taste of the performer. As the slider is pulled toward you, the drums are emphasized, while the opposite setting emphasizes the cymbals and other higher pitched percussive instruments.

EXTRA PERCUSSION

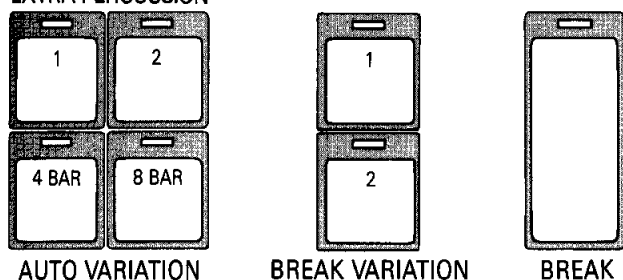

[BREAK VARIATION]

During a live performance, a drummer will occasionally change from the basic pattern and add a slight variation, or BREAK, to provide interest. The BREAK VARIATION buttons accomplish this task. Try the following example, to familiarize yourself with the operation of this function:

- 1) Start the Auto Rhythm Unit.
- 2) Select one of the two BREAK VARIATION buttons. A total of 32 different Break Variation patterns (16 Rhythms × 2 Patterns each) can be produced.
- 3) Press the "BREAK" button.

Once activated, the BREAK VARIATION will begin immediately, providing up to one full measure of the "fill-in" pattern.

The Break Variation will continue until the end of that measure, and will automatically return to the original rhythm at the start of the next measure.

Should you desire a longer BREAK pattern, hold the "BREAK" button.

NOTE: When a BREAK VARIATION is in use, the RHYTHMIC CHORD pattern will continue by changing to a pattern which compliments the "fill-in" for the duration of the BREAK VARIATION, and then will resume its normal pattern.

● PRODUCING AN INTRODUCTION

The BREAK VARIATION function can also be used to create a rhythmic introduction. To accomplish this, select a rhythm and BREAK VARIATION and press the "BREAK" button. Then, the rhythm is activated with the START selector, the BREAK VARIATION will begin as an introduction.

— FOOT SWITCH —

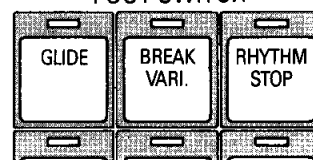

[AUTO VARIATION]

A live drummer will add variation to the rhythm pattern at regular intervals, in addition to "fill-ins," in order to coordinate with the "natural breaks" (or phrases) in music. These generally occur at 4 Bar or 8 Bar intervals.

To further add a more "human-like" quality to your Auto Rhythm Unit, YAMAHA has provided AUTO VARIATION, which will automatically add variations different from those of the Break Variation patterns every 4th or 8th measure.

[EXTRA PERCUSSION]

The Auto Rhythm Unit of YAMAHA Electone F-55 has eight different percussion sounds. Each of the 16 rhythm uses some, but not all, of those percussion sounds. The EXTRA PERCUSSION control allows you to add percussion sounds which are not preset in a particular rhythm pattern by selecting either Button 1 or Button 2 or both. These Extra Percussion sounds are added to the normal rhythm pattern.

[FOOT SWITCH CONTROLS]

By using the Foot Switch (located at the rear left of the Expression Pedal), you can start or stop the rhythm accompaniment, or change to a Break Variation whenever you wish, without having to remove your hands from the keyboard.

● RHYTHM STOP button:

If this button is selected and the FOOT SWITCH is moved to the left, the Rhythm will stop. If the FOOT SWITCH is activated again, the rhythm will re-start from the first beat of the first measure.

● BREAK VARIATION button:

When this button is selected, the Break Variation will begin at the time the Foot Switch is pushed to the left. As previously noted, once activated, the BREAK VARIATION will continue until the end of that measure and will automatically return to the original rhythm at the start of the next measure. If a longer break is desired, simply hold the Foot Switch to the left.

● GLIDE button:

The Foot Switch can also be used to add the GLIDE effect, as discussed previously on page 9.

AUTOMATIC FEATURES

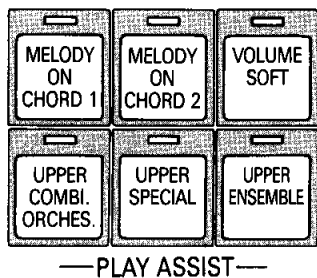

[PLAY ASSIST]

The PLAY ASSIST section enhances single note melodies by transforming them into beautiful harmonies (based on the Lower Keyboard notes played) in two different playing styles: MELODY ON CHORD 1, MELODY ON CHORD 2. In either of these modes, harmonies are automatically added to the melody, and this is easily accomplished by following the three simple steps outlined below:

- 1) Select and press the button corresponding to which mode you wish to use.

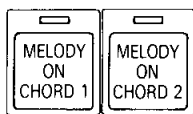

Often called "Closed Harmony" (because the notes involved are spaced close together), these modes provide a "Full Chord" style. Up to two additional notes will be automatically added beneath the melody when MELODY ON CHORD 1 is used. A third note becomes available when using MELODY ON CHORD 2, making up to three additional notes available in total.

- 2) Select and press which voice you wish to use to play the melody. Be sure that the appropriate Voice Section has been turned on in the ENSEMBLE SECTION.
- 3) Select which voices you wish to use to play the harmony notes, and activate that section(s) by using one or more of the three selectors in the PLAY ASSIST (not ENSEMBLE) section.

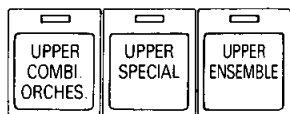

- ★ REMEMBER TO MOVE THE VOLUME SLIDERS FOR THE MELODY AND HARMONY VOICES DOWNWARD.

- 4) Now, play a melody on the Upper Keyboard and hold a chord on the Lower Keyboard to hear the resultant harmony.

● VOLUME SOFT

When using the Play Assist feature, it is sometimes desirable to make the melody more prominent in relation to the "assist notes." By pressing this button, the volume of the "assist notes" (harmony) will be decreased slightly.

● KNEE LEVER CONTROL

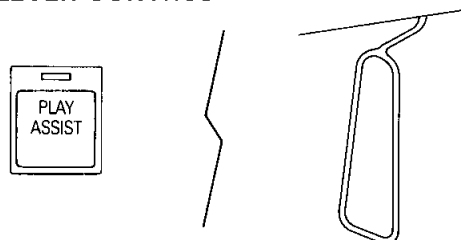

The Knee Lever (located beneath the keyboards) can be used to turn the PLAY ASSIST function "ON" or "OFF," thus enabling a variety of voicings in any given song. To operate, press the PLAY ASSIST button (located in the KNEE LEVER section) and then move the Knee Lever into a vertical position, placing it to the right of your right knee.

When you arrive at a point in your musical performance where you want to use the PLAY ASSIST function, move the Knee Lever to the right. Hold the lever in this position for as long as you desire that function to be active, and release the lever when you want to turn it off. In this way, you can obtain a performance which is more musically expressive and therefore avoid the monotony of having everything sound "mechanical!"

● PLAY ASSIST and AUTO BASS CHORD

The PLAY ASSIST section will also operate in any mode of ABC, making it even easier to obtain the sounds of a "professional" from the very beginning. (In addition, if both the LOWER MEMORY and RHYTHM are on, it is not necessary to hold down the Lower Keyboard notes to obtain the "assist notes" (harmony). (Refer to Page 14)

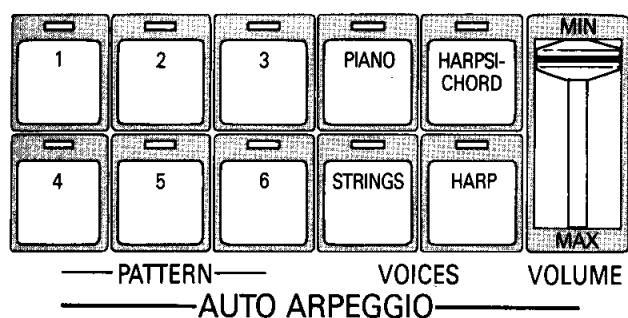

[AUTO ARPEGGIO]

This function automatically produces arpeggios (a series of notes, most often derived from a chord, in which one note at a time is played in succession, from the lowest note to the highest), providing a sparkling background accompaniment. Due to technological advancement, what once took many hours of practice to be able to execute can now be accomplished automatically by simply holding one or more notes on the lower Keyboard.

To familiarize yourself with the operation of this function, please try the following example:

1) Select a rhythm and press SYNCHRO START.

Auto Arpeggio operates in synchronization with the Auto Rhythm Unit, and therefore, you must activate the rhythm in order to hear the Arpeggios. Please note that in this case, because SYNCHRO START is being used, the RHYTHM and ARPEGGIO will start simultaneously (when you reach step #4).

2) Select and press one of the six Pattern Selectors.

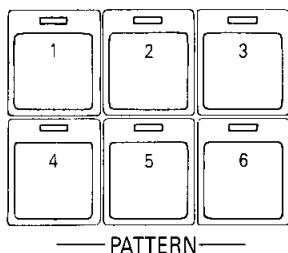

These patterns will vary from rhythm to rhythm, and sometimes within variations of the same rhythm."

3) Select and press one of the four Voice Selectors.

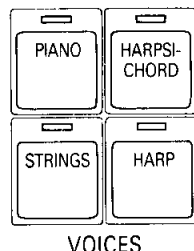

This determines which voice will execute the selected Arpeggio pattern.

4) Pull the VOLUME slider toward you, and hold some notes on the Lower Keyboard.

You will now hear an arpeggio based on those notes which you have pressed. Because arpeggios are generally derived from chords, your Auto Arpeggio section will also produce arpeggios when the Auto Bass Chord (see page 14) function is in use.

- ★ Arpeggios will be produced based on any chords created by the Single Finger Chord system.
- ★ With Fingered Chord and Custom A.B.C., arpeggios will be produced based on the Lower Keyboard notes pressed.
- ★ If LOWER MEMORY is on, the arpeggio will continue to play even after your fingers are removed from the Lower Keyboard.

NOTE: When BREAK VARIATION is activated, the Auto Arpeggio will temporarily stop until the break is completed.

5) Take a few moments to experiment with the Auto Arpeggio function to become familiar with its numerous possibilities.

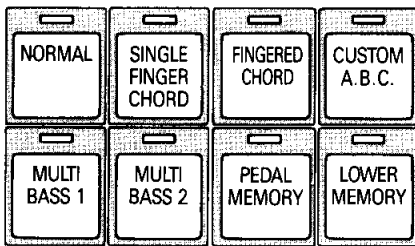

-AUTO BASS CHORD-

[AUTO BASS CHORD]

The AUTO BASS CHORD section is sometimes referred to as the "Easy Play" section in that with almost no musical background, advanced styles of chord and bass accompaniment can be produced. From the beginners to the advanced players, the Auto Bass Chord feature will always add to your performance.

● SINGLE FINGER CHORD

SINGLE FINGER CHORD is the fastest and easiest mode of play in the AUTO BASS CHORD section. When in use, you can obtain a total of 48 different chords and bass notes by pressing one, two or three notes on the Lower Keyboard as follows:

1) Major Chords

By pressing only one note, a major chord (whose root or fundamental is the key played on the Lower Keyboard), will result. The diagram below shows the relationship between the key which is pressed and the major chord which is produced.

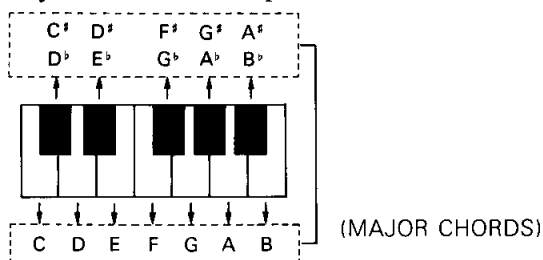

Therefore, if you pressed a "C," you are hearing a "C major chord." If you want an "F major chord," you need only to press the "F" note.

2) Minor Chords

A minor chord can be obtained by simultaneously pressing the key corresponding to the root, and any black key to the left of it.



3) Seventh Chords

By pressing the key corresponding to the root and any white key to the left of it, you can obtain a Seventh Chord (also known as a Dominant Seventh Chord).



4) Minor Seventh Chords

Three notes are required to produce a Minor Seventh Chord in the Single Finger Chord mode. Simultaneously press the key corresponding to the root, and any black (minor) and any white (seventh) key to the left of it.



★ When using SINGLE FINGER CHORD:

- 1 The proper bass note will be automatically provided, based on the Lower Keyboard notes played.
- 2 The chord produced will sound in the same octave regardless of where it is played on the keyboard.
- 3 CUSTOM VOICES cannot be played on the Lower Keyboard.

● FINGERED CHORD

This feature produces a similar accompaniment to the one you experienced with SINGLE FINGER CHORD. However, it allows you to participate a little more, as you continue along in your musical growth. It is also a good feature for someone who has previous keyboard experience, such as with a piano.

Instead of merely pressing a root note (and additional note(s) to determine chord "type" as in Single Finger Chord), FINGERED CHORD permits you to form the chord yourself (by playing the proper 3 or 4 notes). It will then determine what chord you are playing and will automatically select and play the corresponding bass note. With FINGERED CHORD you can obtain a variety of other chords, above and beyond the 48 basic chords available in the Single Finger Chord mode, including Augmented, Diminished, and Suspended 4th Chords. The Chord produced will also sound in the same octave in which it is played, and the resulting performance becomes even more professional.

●CUSTOM A.B.C.

In its most basic usage, CUSTOM A.B.C. is very similar to FINGERED CHORD because it permits you to play the chords manually. However, CUSTOM A.B.C. allows even further participation on your part, advancing your musical growth even more.

Instead of automatically providing the bass, you can press the pedal corresponding to the chord you are playing. At the same time, because the pedals are independent of the Lower Keyboard in the Custom A.B.C. mode, more complex harmonic structures become available. For example, a C major 9 chord can be obtained by playing a C pedal and an E minor 7 chord.

●AUTO BASS CHORD and the AUTO RHYTHM Unit

When any mode of the ABC section is used with the Auto Rhythm Unit, the resulting accompaniment is automatically synchronized (in tempo) with the rhythm. Instead of a continuous sound, the bass and chord accompaniment become "animated" in a rhythmic style which is complimentary to the rest of the rhythmic accompaniment. In these instances, the RHYTHMIC CHORD feature (found in the lower SPECIAL PRESETS section) provides the animated chord accompaniment, while the MULTI BASS feature supplies the automatic bass patterns. The following example will illustrate this point.

- 1) Select a rhythm.
- 2) Select and press one of the three styles (modes) of play (SINGLE FINGER CHORD, FINGERED CHORD or CUSTOM A.B.C.).
- 3) Turn on the RHYTHMIC CHORD of the Lower Special Presets.
- 4) Select the desired Pedal sounds.
- 5) Make sure that all corresponding VOLUME sliders are moved downward.

Now, once the Auto Rhythm Unit is activated, and the Lower Keyboard is held (Pedal Keyboard also, in CUSTOM A.B.C. mode), you will hear an automatic accompaniment (both drums and instrumental) in synchronization with the Auto Rhythm Unit.

●MULTI BASS

This section allows you to change the automatic bass pattern from a normal pattern (generally root only) to two other, more interesting alternatives. The pattern will change, depending upon the Rhythm and MULTI BASS pattern selected. So take a few moments to listen to some of the possibilities.

IMPORTANT: MULTI BASS operates in synchronization with the Auto Rhythm Unit and therefore the RHYTHM (and ABC SYSTEM) must be activated to hear these patterns.

NOTE: When a BREAK VARIATION is in use, the MULTI BASS pattern will continue by changing to a pattern which compliments the "fill-in" for the duration of the BREAK VARIATION, and then will resume its normal pattern.

●LOWER MEMORY and PEDAL MEMORY (Operates only when the Auto Rhythm Unit is ON.)

The purpose of these effects is to provide a continuation of the Lower or Pedal Keyboard sounds even after you have removed your hand (foot) from the Lower Keyboard (Pedal). The MEMORY sections are independent of each other and can, therefore, be used either separately or together. These effects are available with all modes of Auto Bass Chord (including NORMAL) and are especially useful when using Rhythmic Chord, Auto Arpeggio, Multi Bass or Play Assist.

●NORMAL

This button is used to cancel all AUTO BASS CHORD modes and to return your Electone to a normal (conventional) operating mode. When the NORMAL button is pressed, you may manually play the Lower Keyboard and Pedals to provide your own desired accompaniments without introducing any AUTO BASS CHORD functions.

III. USEFUL INFORMATION ABOUT THE ELECTONE

[ACCESSORY JACKS AND SOCKETS]

Several jacks and sockets have been included in the design of your Electone in order that a variety of optional accessories may be used.

● STEREO HEADPHONES Jack

This jack is to be used to connect stereo headphones (optional). When headphones are connected, there will be no sound from the Electone's speakers. This allows you to play your Electone at any time without disturbing others.

NOTE: You can also use monaural headphones in this jack without damaging either the Electone or the headphones.

IMPORTANT: Do not use this jack for any purpose other than headphones!

● AUX. OUT (LEFT/RIGHT) Jacks

These jacks have been provided to permit the connection of your Electone to most stereo tape recorders that have "Line In" jacks. This allows a direct recording without any outside noise.

Here, connect to the LEFT jack when recording in the monaural mode.

● AUX. IN Jack

The "Aux. In" jack can be used to connect most tape recorder/players having "Line Out" jack. This permits you to play back recordings through the Electone's speaker system. By using this jack, you can also perform together with previously recorded music.

NOTE: The sounds reproduced utilizing this jack is not controlled by the volume pedal.

● EXP. IN Jack

This jack accepts a monaural signal from synthesizers or similar accessories (designed to provide approximately 2 vpp [two volts, peak-to-peak] into a 10k ohm load). The volume of the equipment attached here will be controlled by the Electone Expression Pedal.

WARNING: The connection or disconnection of any accessory (other than headphones) while the Electone is ON, can result in extensive damage to the Electone and/or the accessory.

Damage caused by the improper connection of accessories is not covered by the manufacturer's warranty.

● Tone Cabinet Connectors

These two sockets are designed to be used with amplified speaker systems. A thirteen (13) pin socket has been provided to permit the connection of Yamaha designed and produced Tone Cabinets. A second socket having eleven (11) pins has been provided to allow the connection of Leslie® Speaker Systems or other comparable systems having the exact same engineering requirements.

★ Yamaha Tone Cabinets may not be readily available in all market areas. Contact your dealer for information.

[ELECTROMAGNETIC INTERFERENCE]

"Interference" can be a two way street; something you are operating can interfere with others or, something someone else has may interfere with something of yours. Naturally, it is also possible that two or more of your own electronic (electric) devices may interfere with each other. Your Electone has been designed to minimize all these possibilities and meets all applicable standard worldwide.

Electromagnetic interference with your Electone can show itself in a variety of ways. You may hear speech, music, "beeps," static, or buzzing noises. Yamaha Electones are designed to reject RF (radio frequency) signals that are many times the levels found in any normal environment. If, however, you are in the immediate proximity of a very high power transmitter, some interference may still occur.

If this should happen, please try to identify the radio (TV) station and record the time of day that the interference occurs. Station identification is essential in order that the offending frequencies can be established and the authorized (legal) operating power level of the transmitter causing the interference can be verified. If the interference continues, please follow the corrective measure suggestions provided later in this section.

If the interference is in the form of occasional buzzing or static, it is highly probable that the cause can be traced to the turning on or off of some household appliance. The offending appliance can also be outside your own residence. Usually a "time" pattern (i.e., evenings only, etc.) will be involved. Noises of this type rarely originate in the Electone itself. If the condition continues, please contact your local authorized Yamaha Electone dealer for assistance.

Main power line disturbances and electrical storms (lightning) can also be the source of static interference. Generally speaking, problems generated by these two sources will also be present in your other audio or video equipment. Lightning can also be very destructive. The following special warning also applies to virtually all electronic products.

IMPORTANT NOTICE

Modern electronic products, (i.e., computers, video games, electronic organs, etc.), contain components that, under normal conditions, extend the service free life of the products they make up by an almost unbelievable period of time. This is especially true when you consider the vast number of equivalent components incorporated within one given part. These "parts," called "integrated circuits," are however, subject to destruction by high voltage discharges, such as a close proximity lightning strike. This can occur even if the unit is turned off.

IN PERIODS OF ELECTRICAL STORM PROBABILITY, IT IS ADVISABLE THAT YOU DISCONNECT ANY ELECTRONIC DEVICE NOT ACTUALLY IN USE, FROM ITS WALL SOCKET.

[INSTALLATION AND MAINTENANCE]

Your new Electone does not require professional installation or routine maintenance. However, it is **IMPORTANT** that you be aware of the following:

● **INSTALLATION**

- 1. WARNING:** Do not allow your Electone or its bench to rest on or be installed over power cords of any type. An electrical shock and/or fire hazard could possibly result from this type of improper installation.
- 2. WARNING:** Do not place objects on your Electone power cord or place it in a position where anyone could trip over, walk on or roll anything over it. An improper installation of this type creates a personal injury/fire hazard possibility.
- 3. Main Power Supply Verification:** Your Electone has been manufactured specifically for the main supply voltages used in your area. If you should move, or if any doubt should exist, please consult your local authorized Electone dealer for instructions.
- 4. Environment:** Your Electone should not be installed in a position that exposes the cabinet to direct sun light or air currents having high humidity or heat levels. This type of installation can cause contact oxidation, case joint separation, and cabinet finish problems.
- 5. Vinyl Products:** Do not set vinyl items, (i.e., headsets, vinyl doilies, etc.) on the finished surfaces of your Electone or use a polyvinyl material to cover the unit for any extended period of time. A chemical reaction may occur between the finish chemicals and those contained in the polyvinyl products resulting in a permanent marring of the finish.
- 6. Roll Top/Key Cover:** The roll top was not designed to support decorative items or any weights. Do not permit anyone to sit, lean or climb on this assembly. The roll top assembly is designed to slide into the interior of the console, and we recommend that you use both hands to control the rate of movement until this cover reaches its rest position. Do not lift the entire assembly to operate.
- 7. Electromagnetic Interference (RFI):** Your Electone has been type tested and found to comply with all applicable regulations. However, if it is installed in the immediate proximity of other electronic devices, some form of interference may occur.

● **MAINTENANCE**

- 1. SERVICE:** Your Electone contains no user serviceable components. Refer all service to qualified service technicians only.
- 2. BENCH STRUCTURAL INTEGRITY:** If any motion or an "unsteady" sensation is noted in the bench, please check its structural integrity immediately. Discontinue use until any and all troubles are resolved. The bench was designed for seating only. No other applications are recommended.
- 3. POWER/PILOT LIGHT:** When not in use, always turn your Electone "OFF." A PILOT LIGHT (visible when the roll top is closed) has been provided as a reminder.
- 4. CLEANING/CARE**
 - A) GENERAL:** DO NOT use chemically harsh (i.e., alcohol, paint thinner, etc.) or abrasive cleaners on any portion of your Electone.
 - B) KEYS/CONTROL PANEL:** When cleaning the keys and control panels of your Electone, please use a soft absorbent-type cloth that has been dampened with a very mild solution of liquid soap and lukewarm water.
 - C) CABINET/BENCH:** Clean the cabinet wood/veneer portions of your Electone with a slightly dampened cloth containing a neutral cleaning agent. The cleaning agent selected should not contain a high wax content or any other substance that would have a tendency to fill the pores of the wood or form a "build-up" on the wood surface.

IMPORTANT NOTICE: This product has been tested and approved by independent safety testing laboratories in order that you may be sure that when it is properly installed and used in its normal and customary manner, all foreseeable risks have been eliminated. DO NOT modify this unit or commission others to do so unless specifically authorized by the manufacturer. Product performance and/or safety standards may be diminished. Claims filed under the expressed warranty terms may be denied if the unit is/has been modified. The warranty of title (patent infringement, etc.) will not be defended by the manufacturer in the area(s) that relate to the modification. Implied warranties may also be affected.

[TROUBLESHOOTING]

The following chart contains a few examples of conditions that may be misleading. Naturally, there are idiosyncracies not included in this table. When in doubt, please don't hesitate to contact your dealer for assistance, if the information found in this owner's guide does not adequately answer your questions.

Phenomenon	Possible Cause	Probable Solution
No sound—All indicator lights function normal.	Nothing is On in the Ensemble Section and/or the Volume Sliders are in the MINIMUM position.	Turn on at least one section in the Ensemble Section and make sure that the Volume Slider for that Section is "ON"
Extraneous Sounds coming from the Speaker System: (Voices, Chirps, Buzzing Sounds, etc.)	Radio Frequency Interference, CB, Electric Appliances, etc.	See Electromagnetic Interference Section on Page 16.
Extraneous sounds not being reproduced through the Speaker System (Buzzes, Vibration, etc). Everything has a critical point where it will vibrate. This phenomena is called "Resonance," and may also be referred to by your technician as "Sympathetic Vibration."	A combination of excessive volume and a phenomenon called "resonance." The continuous nature of the tones developed by electronic musical instruments, the variation of the frequencies, and the power levels (volume) involved will naturally cause some objects (i.e., windows objects on shelves pictures, etc.) to vibrate.	If the rattle is outside of the Electone, identify and move the object causing the rattle. It is possible that something within the Electone itself could generate a rattle, especially if the volume used approaches the maximum and/or a specific note is held for some time. A slight reduction in volume should eliminate the rattle. If satisfactory results are not achieved using this method, please contact your dealer for assistance.
TV or Radio Reception is degraded when the Electone is "ON".	The Radio, TV, or their antennas are installed too close to the Electone.	Relocate either the Electone or the Radio or TV. See Electromagnetic Interference Section on Page 16.
One Pedal Plays constantly. Pedals to the right of this note will play. Pedals to the left of this note will not.	Bent Pedal Actuator	Straighten and adjust actuator of pedal that plays constantly.
Lower and/or Pedal Keyboard continues to produce sound, even when hands/feet are removed.	One or both of the Memory Buttons (located in the ABC Section) is on.	If the light is illuminated, that effect is being used. To cancel the effect, press that button until the light goes out.
Pedal sounds produced in the Fingered Chord mode do not sound correct.	This mode does not recognize 6th chords and may/may not recognize 9ths, 11ths, or 13ths, etc, depending on inversion.	When using the Fingered Chord mode, play basic triads, seventh, augmented, diminished, and suspended 4th chords.
Sustain does not work.	The Knee Lever is in the vertical position.	Either move the Knee lever to the right (to add the sustain effect) or return it to its up and locked position.
The number on the Digital Display does not change successively.	To enhance the ease of operation, the rhythm tempo which can be set with the TEMPO knob has been set within a range which does not hinder your performance.	

[SPECIFICATIONS]

KEYBOARDS

Upper: 44 Keys f - c4 (3²/₃ Octaves)
Lower: 44 Keys F - c3 (3²/₃ Octaves)
Pedals: 13 Keys C - c (1 Octave)

COMBINATON/ORCHESTRA

Upper: Combi. 1, Combi. 2, Combi. 3, Combi. 4, Combi. 5, Combi. 6, Combi. 7, Combi. 8, Combi. 9, Combi. 10, Strings, Brass 1, Brass 2, Reed 1, Reed 2, Cosmic
Control: Volume
Lower: Combi. 1, Combi. 2, Combi. 3, Combi. 4, Combi. 5, Combi. 6, Strings, Brass 1, Brass 2, Cosmic
Control: Volume

SPECIAL PRESETS

Upper: Piano, Harpsichord, Vibraphone, Mandolin, Banjo, Jazz Guitar, Brass 1, Brass 2,
Control: Volume
Lower: Piano, Electric Piano, Harpsichord, Jazz Guitar, Solid Guitar, Brass
Controls: Phaser, Rhythmic Chord, Volume

ENSEMBLE VOICES

Upper: Strings 1, Strings 2, Brass, Vocal,
Control: Volume
Lower: Strings 1, Strings 2, Vocal 1, Vocal 2,
Control: Volume

CUSTOM VOICES

Upper/Lower: Flute, Oboe, Clarinet, Saxophone, Trumpet, Trombone, Violin, Jazz Guitar, Cosmic 1, Cosmic 2
Control: Upper Touch Vibrato, Upper Touch Tone, Volume
Pedals: Bass 1, Bass 2, Contra Bass 1, Contra Bass 2, Tuba, Electric Bass
Control: Volume

ENSEMBLE

Upper Combi./Orches., Upper Special, Upper Ensemble, Upper Custom, Lower Combi./Orches., Lower Special, Lower Ensemble, Lower Custom

GENERAL PRESETS

1, 2, 3, 4, 5, 6

EFFECTS/CONTROLS

Symphonic: Celeste, Symphonic, Upper Combi./Orches., Lower Combi./Orches.
Tremolo: Chorus, Tremolo, Upper Combi./Orches., Lower Combi./Orches., Tremolo Speed Control
Orchestra Celeste
Vibrato: Delay, Depth, Speed, Custom Only
Sustain: Switches: Upper Sustain, Lower Sustain
Controls: Upper, Lower, Pedal

Reverb

AUTO RHYTHM UNIT

Pattern Selectors: March, Tango, Waltz 1, Waltz 2, Ballad, Swing, Bossanova, Samba, Latin, Latin Rock, Slow Rock, Bounce, 8 Beat 1, 8 Beat 2, Disco, 16 Beat
Break Variation: 1, 2, Break
Auto Variation: 4 Bar, 8 Bar
Extra Percussion: 1, 2
Controls: Synchro Start, Start, Tempo, Volume, Balance, Digital Display (Tempo), Tempo Indicator Lamp

PLAY ASSIST

Mode Selectors: Melody On Chord 1, Melody On Chord 2
Voice Selectors: Upper Combi./Orches., Upper Special, Upper Ensemble
Controls: Volume Soft

AUTO ARPEGGIO

Pattern Selectors: 1, 2, 3, 4, 5, 6
Voice Selectors: Piano, Harpsichord, Strings, Harp
Controls: Volume

AUTO BASS CHORD

Mode Selectors: Normal, Single Finger Chord, Fingered Chord, Custom A.B.C.
Multi Bass: 1, 2
Memory: Lower Memory, Pedal Memory

MAIN CONTROLS

Manual Balance, Master Volume, Expression Pedal, Power Switch, Power/Pilot Light, Knee Lever (Play Assist, Upper Sustain, Lower Sustain), Foot Switch (Glide, Break Variation, Rhythm Stop)

OTHER FITTINGS

Stereo Headphones Jack, Aux. Out Left/Right Jack, Aux. In Jack, Exp. In Jack, Yamaha Tone Cabinet Connector (13 pins), Leaslie® Tone Cabinet Connector (11 pins), Music Rest, Matching Bench, Locking Roll-top Fallboard

AMPLIFIERS

Center: 30W (rms)
Side: 30W (rms)

SPEAKERS

Center: 30cm (12"), 12cm (4²/₃"), 7cm (2³/₄")
Side: 20cm (18"), 6cm (2¹/₃")

CIRCUITRY

Solid State (incl. LSIs and ICs)
Power Consumption: See Electone nameplate
Power Source: 50/60Hz AC

DIMENSIONS

Cabinet: 115.6(W) × 58.0(D) × 98.2(H)cm
(45¹/₂" × 22³/₄" × 38²/₃")

WEIGHTS

Cabinet: 68kg (150 lbs.)
Bench: 6.8kg (15 lbs.)

FINISH

Cabinetry: American Walnut Veneer with selected solid hardwood components
Finish: American Walnut
Music Stand: Walnut Veneer with decorative routing

★ Specifications subject to change without notice.

[Where to find the nameplate]

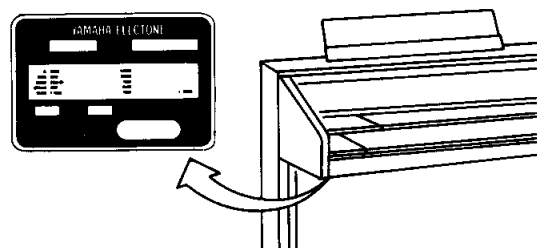

FCC CERTIFICATION (USA)

While the following statements are provided to comply with FCC Regulations in the United States, the corrective measures listed are applicable worldwide.

The digital series of Yamaha Electones™ use frequencies that appear in the radio frequency range, and if installed in the immediate proximity of some types of audio or video devices within three meters (approximately ten feet), interference may occur.

This series of Yamaha Electones™ has been type-tested and found to comply with the specifications set for a class B computer in accordance with those specifications listed in sub-part J, part 15 of the FCC rules. These rules are designed to provide a reasonable measure of protection against such interference. However, this does not guarantee that interference will not occur.

If your Electone™ should be suspected of causing interference with other electronic devices, verification can be made by turning your Electone™ off and on. If the interference continues when your Electone™ is off, the Electone™ is not the source of the interference. If your Electone™ does appear to be the source of the interference you should try to correct the situation by using one or more of the following measures:

- Relocate either the Electone™ or the electronic device that is being affected by the interference.
- Utilize power outlets for the Electone™ and the device being affected that are on different branch (circuit breaker or fuse) circuits, or install a/c line filters.
- In the case of radio-TV interference, relocate the antenna or if the antenna lead-in is 300 ohm ribbon lead, change the lead-in to coaxial type cable.

If these corrective measures do not produce satisfactory results, please contact an authorized Yamaha Electone™ dealer for suggestions and/or corrective measures. If you can not locate an authorized Yamaha Electone™ dealer in your general area, please contact the Electone™ Service Department, Yamaha International, 6600 Orangethorpe Ave., Buena Park, CA 90620, U.S.A.

If for any reason, you should need additional information relating to radio or TV interference, you may find a booklet prepared by the Federal Communications Commission helpful: "How to Identify and Resolve Radio-TV Interference Problems." This booklet, Stock #004-000-00345-4, is available from the U.S. Government Printing Office, Washington D.C. 20402.



YAMAHA INTERNATIONAL CORP.
6600 Orangethorpe Ave.
Buena Park, CA 90620