



YAMAHA Hi-Fi STEREO SYSTEMS

YP.700

STEREO TURNTABLE

Owner's Manual

CENTER

CONTENTS

FEATURES	1
TOP PANEL MECHANISM	2
ASSEMBLY	3
ADJUSTMENT	5
COMPONENT PARTS CONFIGURATION	7
OPERATION	8
REPLACEMENT CARTRIDGE INSTALLATION	9
MAINTENANCE & ACCESSORIES	11
MALFUNCTIONS & SOLUTIONS	12
SPECIFICATIONS	13

FEATURES

INTRODUCTION

We at Yamaha would like to thank you for selecting the YP-700 Turntable and we congratulate you on your choice. The YP-700 is the latest addition to the Yamaha family of superb audio components. In it you will find some of the world's best known features for the reproduction of stereo music, flawlessly

assembled by our expert craftsmen.

This manual has been prepared to instruct you in the operation and care of the YP-700. Given the proper care, this precision component will be a most welcome addition to your stereo system, providing many care-free hours of listening enjoyment. Please read the following instructions carefully before operating the turntable.



SPECIAL FEATURES

The YP-700 employs a professional type belt drive system, a superior method of providing constant speed control and reducing vibrations.

The turntable platter is solid, die-cast aluminum, perfectly balanced to reduce distortion to an absolute minimum.

Yamaha's unique Double Float Mounting system eliminates chassis (induced) vibrations by mounting the turntable and tone arm on a single base, isolated from the chassis by shock-absorbing spring mounts. The motor is similarly mounted on a separate base, further reducing the minuscule motor vibrations that reach the turntable base to an unmeasurable quantity.

The cue lever provides a means of stopping play at any time and then re-starting again at the same point. Use of the lever provides the correct starting stylus pressure, reducing the possibility of damaging the stylus and/or scratching the record when playing only a selected portion of a record.

TOP PANEL MECHANISM

NOMENCLATURE

- ① Auto-return holding tape
- ② Red-topped transit holding screws (5)
- ③ Motor pulley
- ④ Cueing lever, oiled damped
- ⑤ Cycle changeover switch (50 or 60 Hz)
- ⑥ Tonearm securing ribbon
- ⑦ Tonearm rest
- ⑧ PLAY/OFF switch
- ⑨ Speed selector switch
- ⑩ Lubrication hole
- ⑪ Cartridge shell fastener
- ⑫ Tonearm
- ⑬ Voltage selector
- ⑭ Head shell
- ⑮ Hook screw
- ⑯ Anti skate weight
- ⑰ Lateral balance weight
- ⑱ Main weight
- ⑲ Spare Pulley

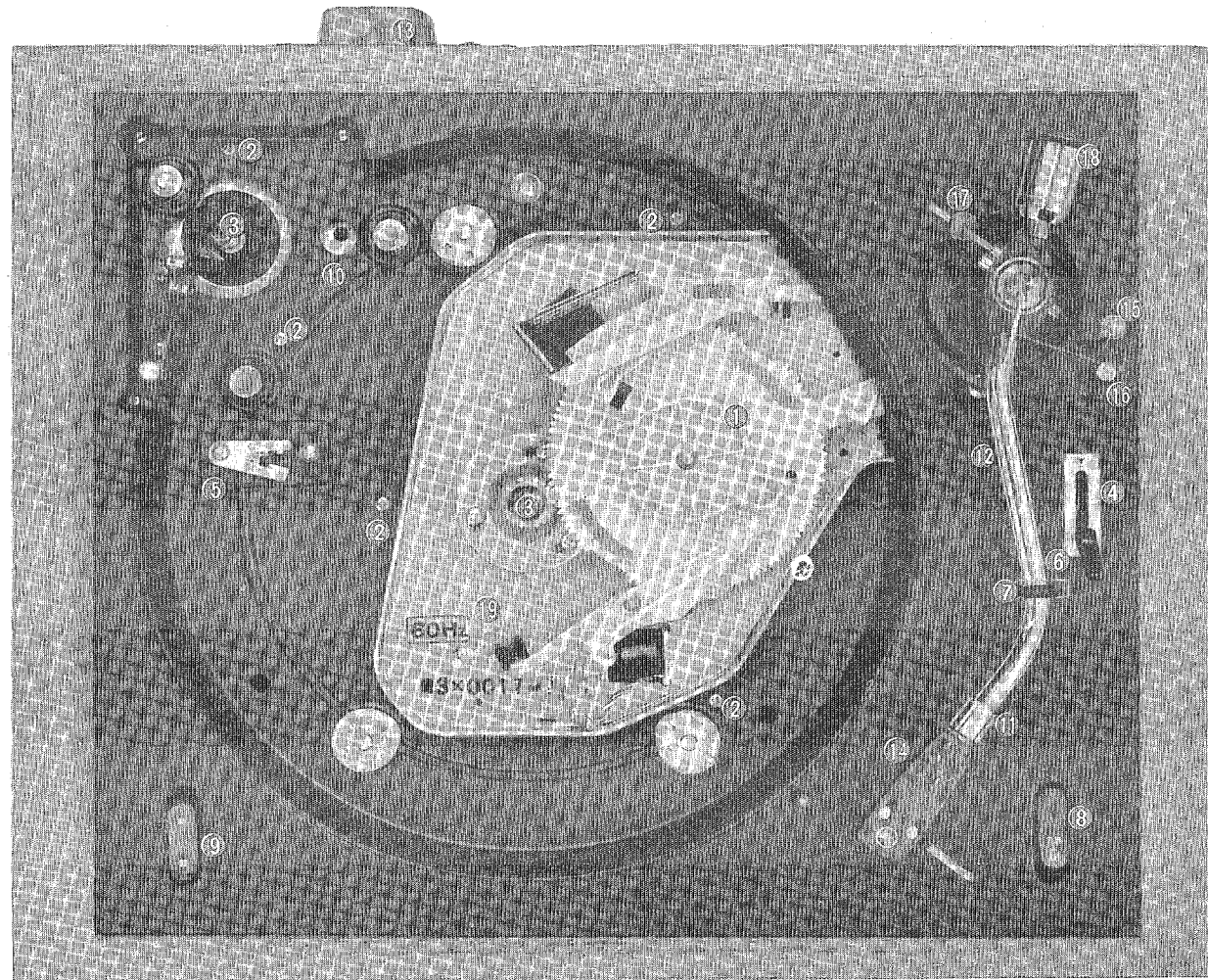

ASSEMBLY

TOP PANEL

1. Remove the 5 red-topped base hold down screws and store them in the accessory case. Remove the tape holding the auto-return mechanism.

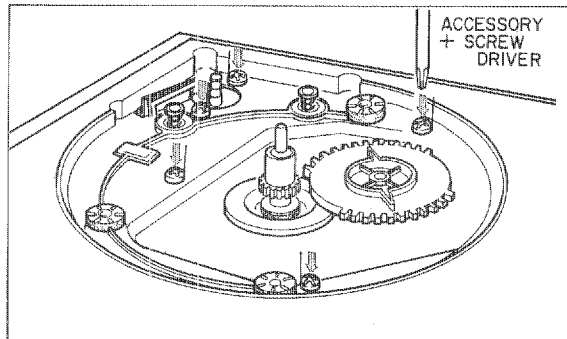

Fig. 1

VOLTAGE SELECTOR

2. Insure the voltage selector is adjusted to the voltage of your area. If it must be changed, select the appropriate setting, i.e., 100, 110, 117, 125, 220, or 240 volts.

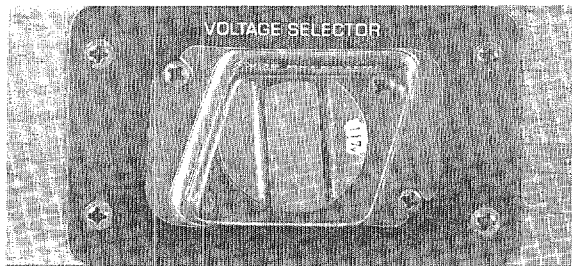

Fig. 2

3. Visually inspect the motor pulley and determine if it is compatible with the frequency of your electrical system. The pulley with a black top is for use with 60 Hz, the red topped pulley is used with 50 Hz. If the pulley must be changed, remove the spare pulley and its changeover switch from the holder and install them. Return the unused pulley to the holder.

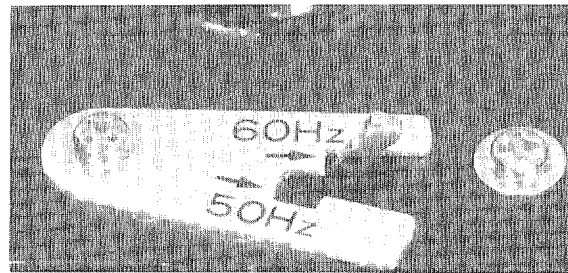

Fig. 3

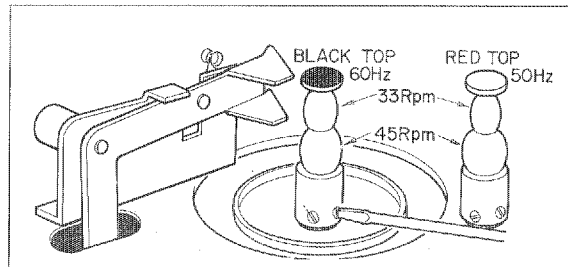

Fig. 4

4. Before applying electrical power to the unit, press the PLAY/OFF switch so that the auto-return system will engage the center shaft gears, then set the speed selector switch at 33 rpm. (Fig. 5)

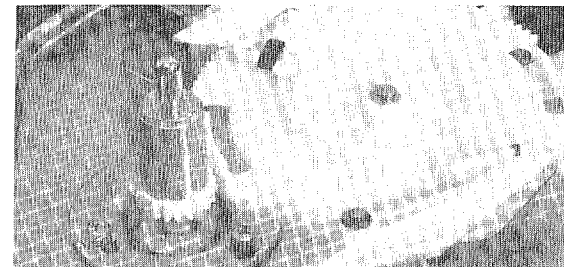

Fig. 5

TURNTABLE PLATTER

5. Slide the platter carefully over the center shaft, taking care not to damage the pin on the under side. At the same time, pull out on the drive belt (by grasping the ribbon attached to it) and slip the belt over the motor pulley, threading the belt through the speed change guide as you do so, Fig. 6. When the belt is in position, remove the ribbon, put the rubber sheet on the platter and snap the triangular pulley assembly cover into place.

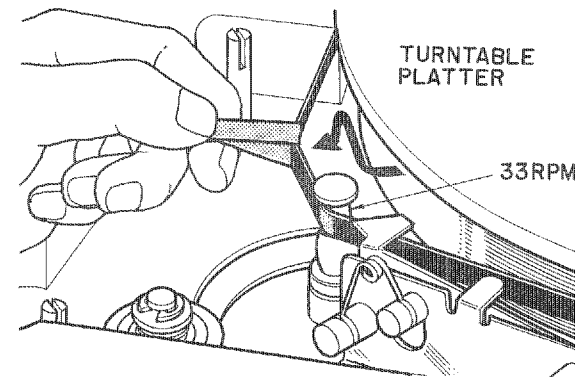

Fig. 6

ASSEMBLY

TOPE ARM

6. Remove the tie-down ribbon and protective tape from the tone arm and plug the cartridge into the end of the tone arm.
7. Remove the main tone arm weight from the accessory box and screw it onto the end of the arm (Fig. 7)

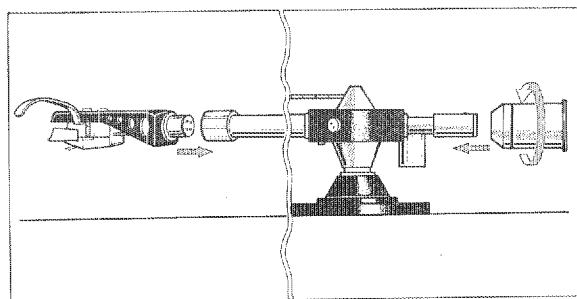

Fig. 7

8. Plug in the power cord. The turntable platter may shift slightly as the gears of the mechanism align themselves. Turntable assembly only is now complete.

ADJUSTMENT

STONE ARM BALANCE

NOTE:

Place a piece of foam rubber under the stylus to prevent damaging stylus while tone arm is being balanced.

Lift the tone arm clear of the arm rest and move it over and behind the arm rest (Fig. 8). The auto-return, auto-cut and anti-skate mechanisms are automatically disconnected when the tone arm is in this position. Adjust the main weight in or out until the tone arm is in a freely balanced position (parallel with turntable base, Fig. 9). When the tone arm is balanced, return it to the arm rest.

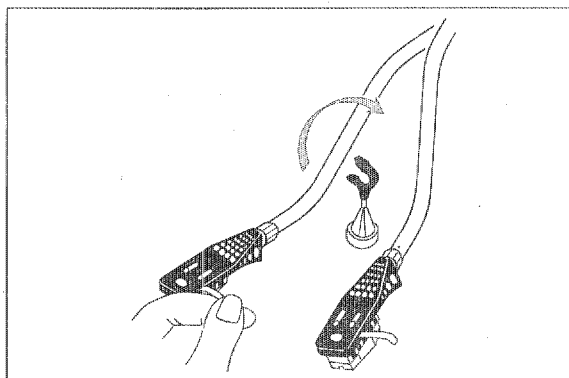

Fig. 8

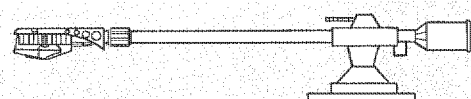

Fig. 9

LATERAL BALANCE

Insert the lateral balancer in the lateral balance hole so that the adjusting screw is at the back.

Turn off electrical power to the unit and position the cueing lever to the PLAY (forward) position. Remove the inside force canceller weight vertically, balance the tone arm.

Tilt the back of the unit up (Fig. 10). Adjust the lateral weight so that a line drawn from arm center to stylus tip will be rectangular to the cabinet line. (Fig. 11).

After adjustments are complete, tighten the lateral weight screw.

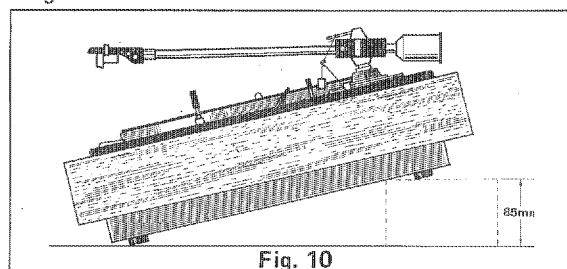

Fig. 10

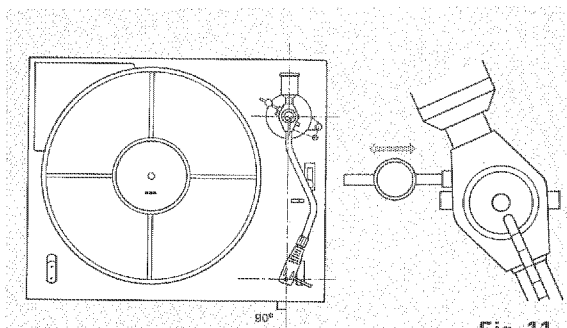

Fig. 11

STYLUS PRESSURES

After the tone arm is balanced, stylus pressure can be set. (Fig. 12) Proceed as follows:

- Hold the main weight so that it cannot rotate and adjust the counter ring in front of the main weight until "0" is centered at the top.
- Rotate the ring counter-clockwise until "2" is centered on top. This indicates a stylus pressure of two grams, which is the correct stylus pressure for the Yamaha cartridge.

If a different cartridge is used, stylus pressure adjustment is accomplished in the same manner. Be sure to adjust stylus pressure at two grams.

Use of a different cartridge may require re-balancing of the tone arm.

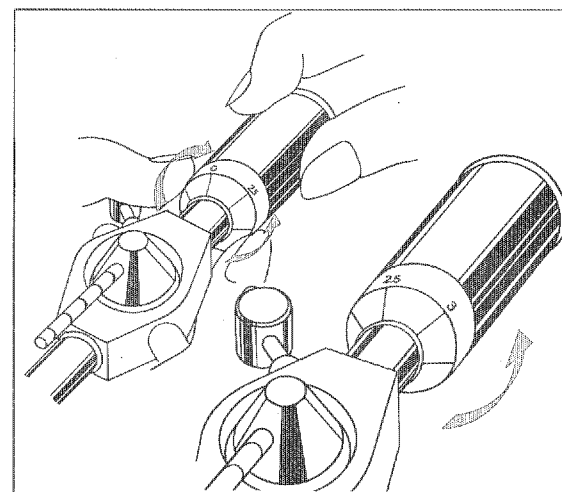

Fig. 12

ADJUSTMENT

ANTI-SKATE MECHANISM

Normal stylus tracking has a tendency to pull toward the center when a record is playing. This tendency (force) is called "inside tracking force" or "skating force". The YP-700 has a built-in anti-skate mechanism in the tone arm which assures perfect record track and faithful reproduction of both stereo channels.

INSIDE FORCE CANCELLER

The relation between stylus cartridge pressure and the position of the force canceller weight string is as follows:

Stylus pressure	Groove position
1 gr	1
1.5 gr	2
2.0 gr	3
2.5 gr	4
3.0 gr	5

With the Yamaha cartridge CG-7000, proper pressure is 2.0 gr, therefore adjust at groove position 3. Next, adjust the inside force hook as follows:

- Unfasten the hook screw and set the hook to a position where the weight does not touch the panel when the tone arm is at rest.
- Fine adjustments are required so that the weight does not touch the hook eye when the tone arm is positioned over the platter center spindle.
- Return the tone arm to the arm rest and check to see if the weight now touches the panel.
- If the weight does touch the panel, re-adjust according to steps (a) and (b).

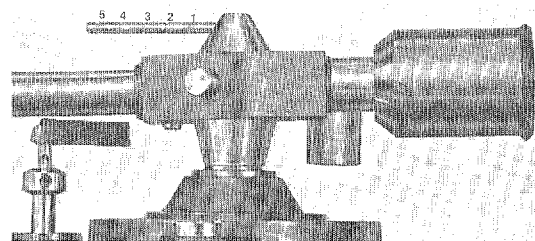

Fig. 13

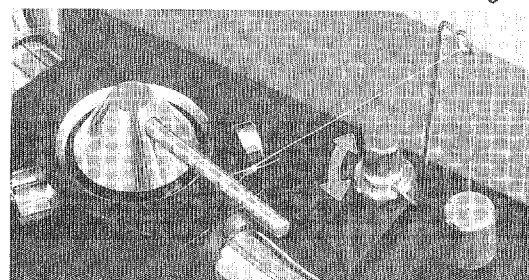

Fig. 14

AFTER ADJUSTMENT

- The location of the YP-700 should be such that it is close to the floor, and on a strong, level table. If the unit is placed on an un-level surface it may cause the stylus to skip or drag on the record, producing an un-natural sound. If the supporting surface is not steady, it will cause the stylus to skip with each vibration.
- When the YP-700 is placed close to an amplifier it may pick up induced hum from the amp. Increasing the distance between the two units will eliminate this type of induced noise.

- When the unit is not in use and the power ON indicator light is illuminated, it signifies that the turntable motor is running. If this condition is allowed to continue it may cause the drive belt to break, jump off the motor pulley or disengage itself from the platter. If the belt becomes disengaged, un-plug the unit from the wall outlet, remove the platter and slip the belt over the pulley, lower the platter onto the spindle, threading the belt through the speed change guide as you do so. Do NOT allow the motor to run free without driving the platter. This may cause over-heating and damage to the motor. Turn off the unit when not being used.

- If the turntable is placed on or next to a speaker it may cause howling through the speaker system due to feed back between the cartridge and the speaker. Speaker vibrations will also cause the stylus to skate or jump on the record surface, damaging the stylus and the record.

- Do not change the speed selector when the unit is not ON. Shifting of the internal gear system when record speed is changed requires electrical power. If changes are attempted when the unit is off, it may stretch the drive belt, which will cause the turntable to produce abnormal sound.

COMPONENT PARTS CONFIGURATION

BEFORE YOU COMMENCE PLAYING A RECORD DOUBLE CHECK THE FOLLOWING ITEMS:

When you prepared the turn table for play did you remove the five red-topped holding screws? Did you remove all the metal fittings used for shipment? Did you follow the assembly instructions completely during set-up?

If the washers and metal fittings are not removed before use, motor vibrations may be heard through

the speakers. If the tape wasn't removed from the auto-return mechanism it will not work smoothly. Is the proper motor pulley installed, with the drive belt over the pulley and through the change-over guide? If the wrong pulley is installed it will cause the platter to revolve too slowly or too fast. If the drive belt is not over the motor pulley the platter will not turn. If the belt is not threaded through the change-over guide, record speed cannot be changed and it may damage the drive belt.

Is the pressure of the stylus properly adjusted? The correct pressure for the installed CG - 7000 is 2 gr. Incorrect stylus pressure will cause distortion

in the speaker output and may damage the stylus and/or record.

Did you remove the protective cover from the stylus? If you attempt to play a record with the cover installed there will be no sound output and the record will be damaged.

Is the turntable vertically placed on a sturdy surface? If not, the output will be distorted and may cause damage to the record and the stylus.

Is the turntable properly connected to the stereo amplifier, L and R outputs of the turntable connected to the L and R inputs of the amplifier? If not, there may be distortion in the output and reversal of channels.

COMPONENT PARTS CONFIGURATION

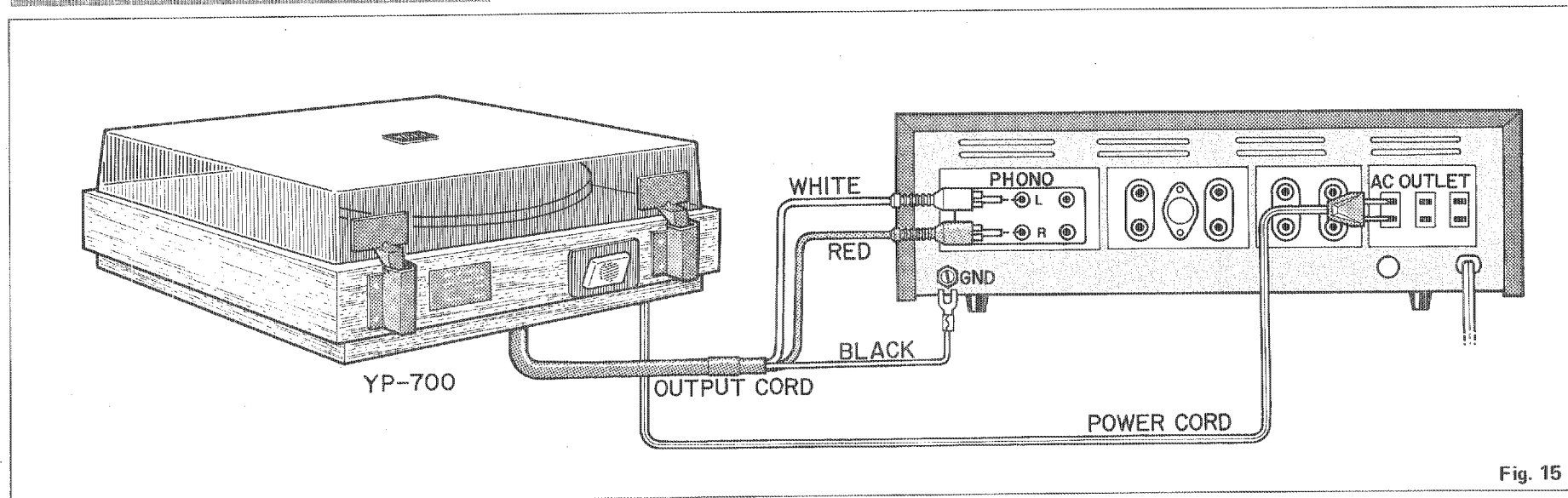

Fig. 15

OPERATION

Place a record on the turntable. If necessary, insert the 45 rpm adaptor. Select the proper speed, according to the type of record to be played, then turn on the amplifier and select the PHONO position with the function switch. Position the tone arm over the beginning of the record and press the PLAY/OFF switch. The turntable will begin to revolve and the tone arm will automatically lower the stylus to the correct position.

(A)

- * This set incorporates an automatic signal cut-out to eliminate the unpleasant sound caused by the stylus meeting the record surface. It functions during the first one or two revolutions of the turntable after the stylus is in the groove.
- * Since the auto-return mechanism is triggered by tonearm movement at the end of the record, it may be impossible to begin replay in the normal fashion near this point. In this case, press the PLAY/OFF switch and then place the tonearm manually at the desired position.

(B)

When the record finishes, the tonearm will automatically lift and return to its rest position and the turntable will stop.

- * At the end of the record the auto-return may not function if the ending grooves are less than 3 mm apart. In this case, push the PLAY/OFF switch.

(C)

If you wish to stop in the middle of a record, simply press and release the PLAY/OFF switch. The auto-return mechanism will activate and stop play, returning the tone arm to the rest position.

(D)

- * The auto-return mechanism is triggered and released by a switch on the underside of the turntable, approximately 3 seconds are required for it to stop play.

(E)

For temporary interruptions, such as a telephone call during record play, use the cue lever to raise the tonearm. (Fig. 16)

Play can then be restarted at the precise point where the interruption occurred by returning the cue lever to its previous position.

(F)

Adjust the tone, volume and stereo balance of the amplifier.

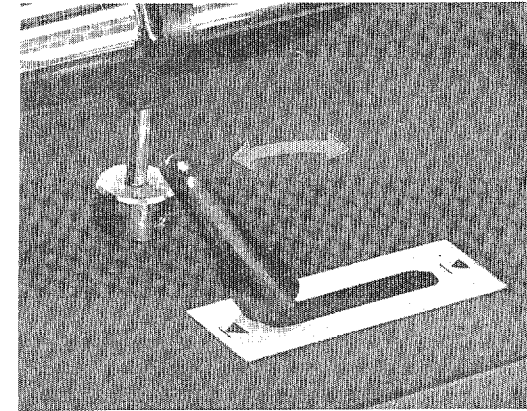

Fig. 16

NOTE:

If the auto-return mechanism consistently acts too early, remove the platter and gently bend the pin on its underside toward the center. If the mechanism consistently fails to function at the end of a record, bend this pin outward (toward the turntable rim)

REPLACEMENT CARTRIDGE INSTALLATION

CHANGING THE CARTRIDGE

The Yamaha cartridge shell is fully changeable and can be easily removed if you desire to use a different cartridge. A new cartridge, Yamaha CG-7000E with elliptical stylus, is available as an optional from your Yamaha dealer.

The MM (moving magnet), IM (induced magnet) and MC (moving coil) type cartridges can be used with the YP-700. If the cartridge conforms to EIA standard dimensions, simply attach it to the shell, then re-mount the shell on the tone arm. If a MC type cartridge is used it may be necessary to employ a step-up transformer between the turntable and the stereo amplifier. The signal output of some types of MC cartridges is so low that the signal cannot be picked up by the amplifier. Some of the newer type high output MC pickups do not require this added amplification. When any cartridge is installed, always consult the cartridge manufacturers instructions before installation.

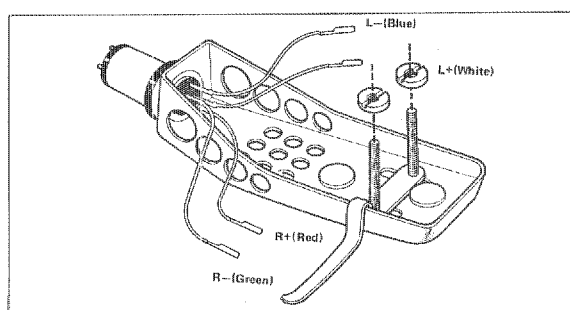

Fig. 17

Connect the shell leads to the cartridge as shown in Fig. 17, then attach the cartridge to the shell and plug shell into tone arm.

CARTRIDGE DIMENSIONS AND WEIGHT

The Yamaha cartridge included with this unit, the CG-7000, is 17 mm high. If a larger one is used, the cartridge body will scrape the record.

Head shells which mount the body too low (less than 18 mm) cannot be used. The height of the arm lifter on any replacement shell must also be considered when selecting a replacement cartridge. If the arm is too high (Fig. 20), it will strike the turntable dust cover when the arm lifts. Such a shell must not be used.

To obtain the desired 2.0 g stylus pressure, a cartridge used with the HS 700 shell should weigh between 6 and 15 gr. The combined weight of cartridge and shell will be between 11 and 22 gr. If the cartridge weighs more than 22 gr. use the subweights to balance the tone arm. When using light-weight cartridges attach the special shell weight adjusting plate (included in the accessories kit) between the cartridge and the shell. A head shell step-up transformer which is sometimes used with the MC type pick-ups, cannot be used because the combined weight would be more than 30 gr.

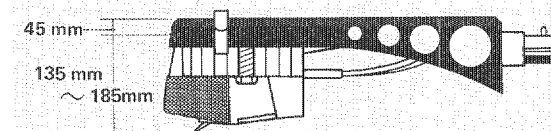

Fig. 18

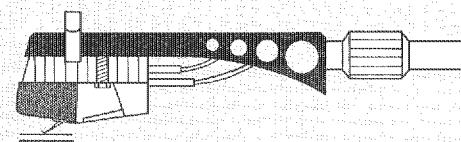

Fig. 19

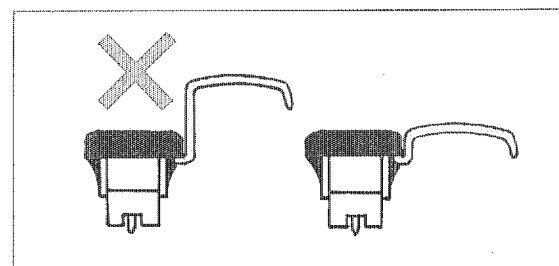

Fig. 20

REPLACEMENT CARTRIDGE INSTALLATION

OVERHANG

Tone arm design calls for an overhang of 17 mm (Fig. 21). When attaching another cartridge to use the two mounting holes that provides an overhang closest to 17 mm. Measure overhang according to Fig. 21.

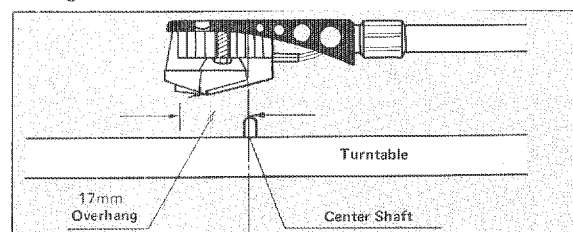

Fig. 21

SUBWEIGHT

Included in the accessory kit are two subweights, (Fig. 22). Use these to balance the tone arm when a heavier cartridge has been installed and the main weight alone is not sufficient to achieve a balanced condition. The subweights are NOT required when Yamaha cartridge CG-7000 is used. As shown in Fig. 22 the two subweights can be combined in varying ways, according to the weight of the cartridge used.

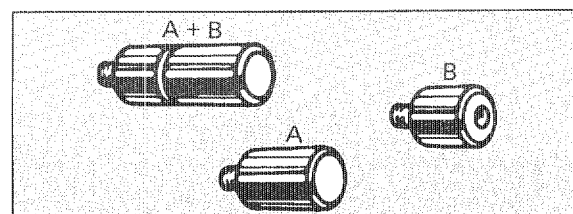

Fig. 22

SUBWEIGHT INSTALLATION

- Unscrew the main weight.
- Screw the subweight(s) onto the rear of the tone arm. (Fig. 23)
- Re-attach the main weight.
- Adjust the main weight according to the tone arm balance procedures on page 5.

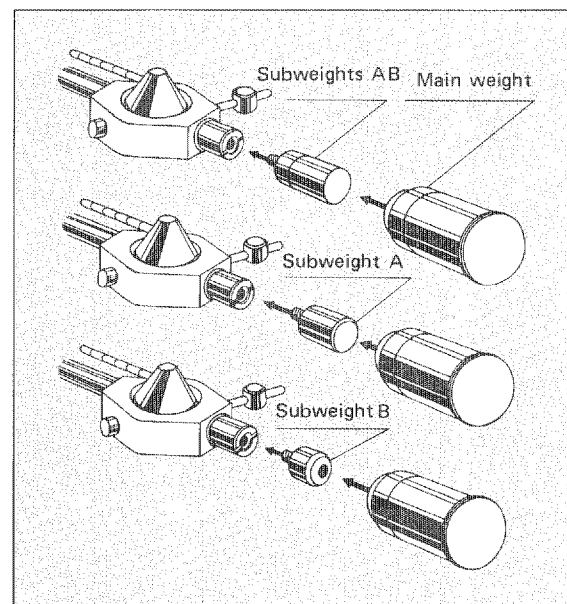

Fig. 23

MAINTENANCE & ACCESSORIES

LUBRICATION

Once per year, add two drops of oil in the lubrication hole under the turntable. No other lubrication is necessary; all other moving parts are self-lubricating.
 * If any oil spills on the belt or connected parts, clean it off thoroughly.

STYLUS CHANGE

The stylus should be changed after every 1000 hours of play. A worn stylus will result in sound distortion and noise, and will damage the record.
 Replace with a Yamaha stylus, Model N-7000.

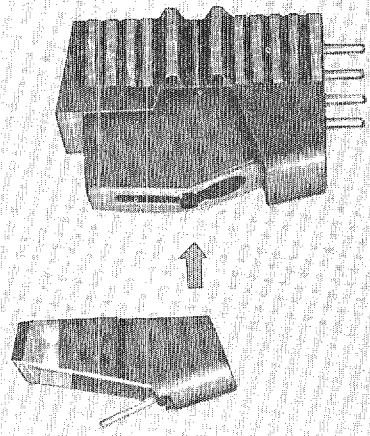

Fig. 24

PACKING FOR SHIPMENT

Follow the assembly procedures in reverse order. Store the turntable (and rubber mat) separately.

Before tapping down the auto-return gear, insure it is in **PLAY** position, i.e., that the part without teeth is facing the turntable shaft gear. Replace the red-topped transit screws.

CLEANING

To clean the cover, use the special cleaner (included in the accessory case) or a soft cloth dampened with mild soap or water. NEVER use solvents, thinners or other petroleum products. The turntable surface and mat

can be cleaned with a damp cloth, but the cabinet requires only a dry cloth. Oiling is not necessary.



RECORDS

Handle records by their edges only. A record can be easily held in one hand by placing one thumb at the center and pressing in on the edge with the other fingers. If a record is extremely dirty, it can be gently washed in mild soap and warm water. This will not damage it in any way. Try to keep the center label dry, as the ink will sometimes run.

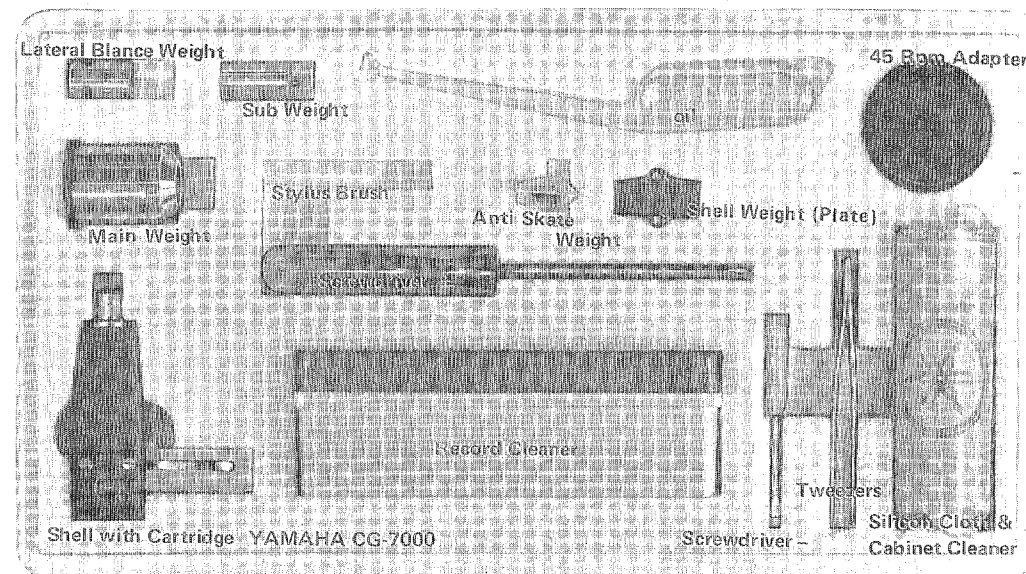
ACCESSORIES



MALFUNCTIONS & SOLUTIONS

MALFUNCTION	CAUSE	SOLUTION
1. Electrical power applied but turntable doesn't operate	Drive belt not installed correctly. Drive belt came off pulley or platter. Drive belt broken.	Re-install drive belt. Re-install drive belt. Replace drive belt.
2. Tone arm Won't descend in manual operation.	Cueing lever is at the  position.	Re-position the cueing lever to the  position.
3. Turntable speed too slow.	Excessive oil on the motor pulley and/or drive belt. Wrong motor pulley installed. Drive belt stretched.	Remove excessive oil thoroughly with alcohol moistened cloth. Change pulley. Replace belt.
4. Motor noise heard through speaker.	Shipping screws and/or metal fittings and washers not removed.	Remove shipping screws and metal fittings.
5. Speed selector and auto-return system doesn't work correctly.	Drive belt not threaded through change-over guide.	Re-thread the drive belt through the change-over guide.
6. Automatic return system stops turntable before record is finished, Auto-return system doesn't work consistently.	Use of non-standard size record. Shipping tape not removed from auto-return mechanism.	Play a standard size record. If problem remains, insure shipping tape removed from auto-return mechanism. If tape has been removed, refer to your Yamaha dealer for adjustment. If problem occurs only on one record, then record ending grooves are too far from the center shaft.
7. No output even though stylus touches record.	Tone arm improperly balanced. Stylus lead broken; disconnected. Stylus protective cover installed. Cartridge mounted improperly. Stylus and/or cartridge bad.	Re-balance tone arm Connect or repair lead(s). Remove protective cover. Mount cartridge correctly. Replace stylus and/or cartridge.
8. Howling or quivering in output. Difficult to hear sound output.	Feedback and/or vibrations, caused by turntable being too close to speaker(s).	Re'locate turntable on firm surface.

MALFUNCTIONS & SOLUTIONS & SPECIFICATIONS

MALFUNCTION	CAUSE	SOLUTION
9. Output distorted and dirty; noisy. Treble is distorted; dirty.	Turntable too close to amp. Turntable not level. Stylus is dirty. Stylus tip worn out. Record damaged or dirty. Stylus pressure incorrect. Amplifier treble control adjusted too high.	Relocate turntable. Level turntable. Clean with stylus brush. Replace stylus. Replace record, clean record. Adjust stylus pressure.

SPECIFICATIONS

TURNTABLE

Type: 2-Speed (33-1/3 & 45 rpm), Belt drive
Motor: Synchronous outer rotor type motor
Turntable Platter: 30 cm in dia, Aluminum diecast
Wow & Flutter: Less than 0.05%
S/N Ratio: 50dB or better

TONE ARM



Type: Static balance type S-formed pipe arm
 W/automatic start/return mechanism
 plus cueing control.
Stylus pressure: 0 to 4 gr.
Head shell: Universal plug-in type, 12gr. in weight.

CARTRIDGE

Type: YAMAHA CG-7000, or equivalent MM
 (moving magnet) type stereo cartridge
 weighting 5 to 15gr.
Output level: 4mV
Stylus pressure: 2.0gr., Optimum
Frequency response: 10 – 25,000Hz
Stylus: Diamond tip, 0.6 mil.
Channel separation: 30dB
POWER SUPPLY: 100, 110, 117, 125, 220 or 240 volts.
POWER CONSUMPTION: 15W.
DIMENSIONS (WxDxH): 480 x 410 x 161mm (19 x 16-1/8 x 6-5/16")
WEIGHT: 9.2kgr. (20.2 lbs.)

 **NIPPON GAKKI CO., LTD.**

HAMAMATSU JAPAN

AOM-1 3610 H.S.  2  Printed in Japan