



RX-V595a

Natural Sound AV Receiver

Ampli-Tuner audio-vidéo

**OWNER'S MANUAL
MODE D'EMPLOI**

SAFETY INSTRUCTIONS

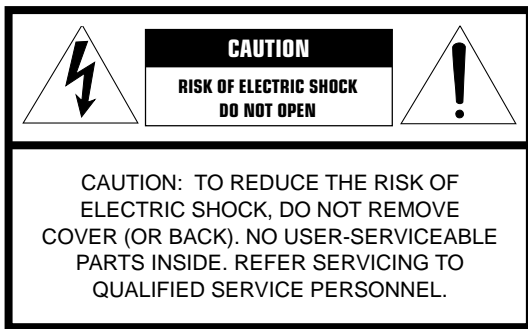

- Explanation of Graphical Symbols

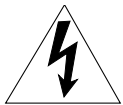

The lightning flash with arrowhead symbol, within an equilateral triangle, is intended to alert you to the presence of uninsulated "dangerous voltage" within the product's enclosure that may be of sufficient magnitude to constitute a risk of electric shock to persons.



The exclamation point within an equilateral triangle is intended to alert you to the presence of important operating and maintenance (servicing) instructions in the literature accompanying the appliance.

WARNING

TO REDUCE THE RISK OF FIRE OR ELECTRIC SHOCK, DO NOT EXPOSE THIS UNIT TO RAIN OR MOISTURE.

- 1 Read Instructions – All the safety and operating instructions should be read before the unit is operated.
- 2 Retain Instructions – The safety and operating instructions should be retained for future reference.
- 3 Heed Warnings – All warnings on the unit and in the operating instructions should be adhered to.
- 4 Follow Instructions – All operating and other instructions should be followed.
- 5 Water and Moisture – The unit should not be used near water – for example, near a bathtub, washbowl, kitchen sink, laundry tub, in a wet basement, or near a swimming pool, etc.
- 6 Carts and Stands – The unit should be used only with a cart or stand that is recommended by the manufacturer.
- 6A A unit and cart combination should be moved with care. Quick stops, excessive force, and uneven surfaces may cause the unit and cart combination to overturn. 
- 7 Wall or Ceiling Mounting – The unit should be mounted to a wall or ceiling only as recommended by the manufacturer.
- 8 Ventilation – The unit should be situated so that its location or position does not interfere with its proper ventilation. For example, the unit should not be situated on a bed, sofa, rug, or similar surface, that may block the ventilation openings; or placed in a built-in installation, such as a bookcase or cabinet that may impede the flow of air through the ventilation openings.
- 9 Heat – The unit should be situated away from heat sources such as radiators, stoves, or other appliances that produce heat.
- 10 Power Sources – The unit should be connected to a power supply only of the type described in the operating instructions or as marked on the unit.
- 11 Power-Cord Protection – Power-supply cords should be routed so that they are not likely to be walked on or pinched by items placed upon or against them, paying particular attention to cords at plugs, convenience receptacles, and the point where they exit from the unit.
- 12 Cleaning – The unit should be cleaned only as recommended by the manufacturer.
- 13 Nonuse Periods – The power cord of the unit should be unplugged from the outlet when left unused for a long period of time.
- 14 Object and Liquid Entry – Care should be taken so that objects do not fall into and liquids are not spilled into the inside of the unit.
- 15 Damage Requiring Service – The unit should be serviced by qualified service personnel when:
 - A. The power-supply cord or the plug has been damaged; or
 - B. Objects have fallen, or liquid has been spilled into the unit; or
 - C. The unit has been exposed to rain; or
 - D. The unit does not appear to operate normally or exhibits a marked change in performance; or
 - E. The unit has been dropped, or the cabinet damaged.
- 16 Servicing – The user should not attempt to service the unit beyond those means described in the operating instructions. All other servicing should be referred to qualified service personnel.
- 17 Power Lines – An outdoor antenna should be located away from power lines.
- 18 Grounding or Polarization – Precautions should be taken so that the grounding or polarization is not defeated.

19 For US customers only:

Outdoor Antenna Grounding – If an outside antenna is connected to this unit, be sure the antenna system is grounded so as to provide some protection against voltage surges and built-up static charges. Article 810 of the National Electrical Code, ANSI/NFPA 70, provides information with regard to proper grounding of the mast and supporting structure, grounding of the lead-in wire to an antenna discharge unit, size of grounding conductors, location of antenna discharge unit, connection to grounding electrodes, and requirements for the grounding electrode.

Note to CATV system installer:

This reminder is provided to call the CATV system installer's attention to Article 820-40 of the NEC that provides guidelines for proper grounding and, in particular, specifies that the cable ground shall be connected to the grounding system of the building, as close to the point of cable entry as practical.

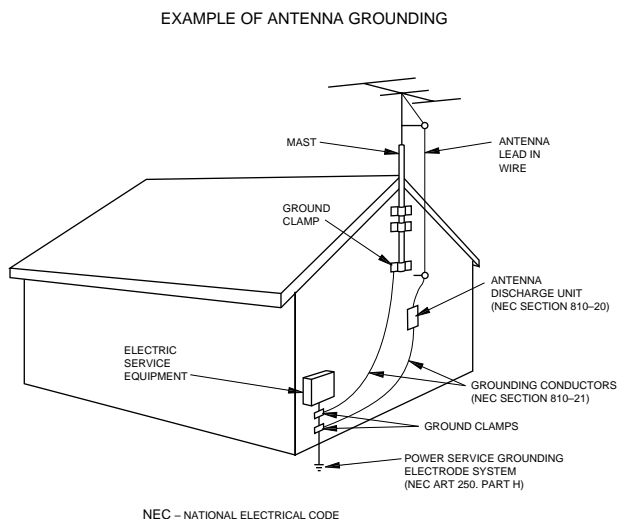

FCC INFORMATION (for US customers only)

1. **IMPORTANT NOTICE : DO NOT MODIFY THIS UNIT!**
This product, when installed as indicated in the instructions contained in this manual, meets FCC requirements. Modifications not expressly approved by Yamaha may void your authority, granted by the FCC, to use the product.
2. **IMPORTANT :** When connecting this product to accessories and/or another product use only high quality shielded cables. Cable/s supplied with this product **MUST** be used. Follow all installation instructions. Failure to follow instructions could void your FCC authorization to use this product in the USA.
3. **NOTE :** This product has been tested and found to comply with the requirements listed in FCC Regulations, Part 15 for Class "B" digital devices. Compliance with these requirements provides a reasonable level of assurance that your use of this product in a residential environment will not result in harmful interference with other electronic devices.

This equipment generates/uses radio frequencies and, if not installed and used according to the instructions found in the users manual, may cause interference harmful to the operation of other electronic devices.

Compliance with FCC regulations does not guarantee that interference will not occur in all installations. If this product is found to be the source of interference, which can be determined by turning the unit "OFF" and "ON", please try to eliminate the problem by using one of the following measures:

Relocate either this product or the device that is being affected by the interference.

Utilize power outlets that are on different branch (circuit breaker or fuse) circuits or install AC line filter/s.

In the case of radio or TV interference, relocate/reorient the antenna. If the antenna lead-in is 300 ohm ribbon lead, change the lead-in to coaxial type cable.

If these corrective measures do not produce satisfactory results, please contact the local retailer authorized to distribute this type of product. If you can not locate the appropriate retailer, please contact Yamaha Electronics Corp., U.S.A. 6660 Orangethorpe Ave, Buena Park, CA 90620.

The above statements apply **ONLY** to those products distributed by Yamaha Corporation of America or its subsidiaries.

We Want You Listening For A Lifetime

YAMAHA and the Electronic Industries Association's Consumer Electronics Group want you to get the most out of your equipment by playing it at a safe level. One that lets the sound come through loud and clear without annoying blaring or distortion – and, most importantly, without affecting your sensitive hearing.

Since hearing damage from loud sounds is often undetectable until it is too late, YAMAHA and the Electronic Industries Association's Consumer Electronics Group recommend you to avoid prolonged exposure from excessive volume levels.



SUPPLIED ACCESSORIES
ACCESSOIRES FOURNIS

- After unpacking, check that the following parts are included.
- Après le déballage, vérifier que les pièces suivantes sont incluses.

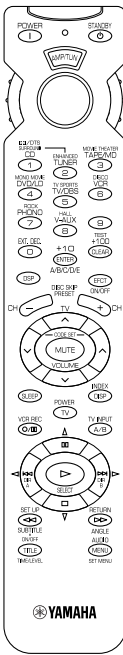
<ul style="list-style-type: none"> • Indoor FM Antenna • Antenne FM intérieure 	<ul style="list-style-type: none"> • Remote control Before using the remote control, install the supplied batteries. See page 48 for battery installation. • Télécommande Avant d'utiliser la télécommande, mettre les piles fournies en place. Pour la mise en place des piles, voir page 98.
<ul style="list-style-type: none"> • AM Loop Antenna • Cadre-antenne AM 	
<ul style="list-style-type: none"> • Antenna adapter (U.S.A. and Canada models only) • Adaptateur d'antenne (Modèles pour les États-Unis et le Canada seulement) 	
<ul style="list-style-type: none"> • Batteries (size AA, R6, UM-3) • Piles (taille AA, R6, UM-3) 	

FEATURES

5-Channel Power Amplification

Minimum RMS Output
(0.04% THD, 20 Hz – 20 kHz)

U.S.A. and Canada models
Main: 70 W + 70 W (8 Ω)
Center: 70 W (8 Ω)
Rear: 70 W + 70 W (8 Ω)

Australia and China models
Main: 65 W + 65 W (8 Ω)
Center: 65 W (8 Ω)
Rear: 65 W + 65 W (8 Ω)

Multi-mode Digital Sound Field Processing

- Digital Sound Field Processor (DSP)
- Dolby Digital Decoder
- Dolby Pro Logic Decoder
- DTS Decoder

- **CINEMA DSP: Theater-like Sound Experience by the Combination of YAMAHA DSP Technology and Dolby Digital, Dolby Pro Logic or DTS**
- **Automatic Input Balance Control for Dolby Pro Logic decoding**
- **Test Tone Generator for Easier Speaker Balance Adjustment**
- **Speaker Output Mode Selection**

Sophisticated FM/AM Tuner

- **40-Station Random Access Preset Tuning**
- **Automatic Preset Tuning**
- **Preset Station Shifting Capability (Preset Editing)**
- **6-Channel External Decoder Input for Other Future Formats**
- **Video Signal Input/Output Capability (Including S Video Connections)**
- **SLEEP Timer**
- **Universal Remote Control with Preset Manufacturer Codes**

CONTENTS

SUPPLIED ACCESSORIES 4

FEATURES 5

CAUTION 6

● **Introduction**

FEATURES OF THE SOUND EFFECTS 7

CONTROLS AND THEIR FUNCTIONS 10

● **Preparation**

SPEAKER SETUP 13

CONNECTIONS 14

ADJUSTMENTS BEFORE USING THIS UNIT 21

● **Basic Operation**

BASIC OPERATION 26

TUNING 30

SETTING THE SLEEP TIMER 35

● **Information about DSP**

SOUND FIELD PROGRAM 36

● **Advanced Information**

ADJUSTMENTS IN THE “SET MENU” MODE 41

● **Remote control**

REMOTE CONTROL 43

SETUP CODES 49

TROUBLESHOOTING 50

SPECIFICATIONS 53

LIST OF MANUFACTURERS’ CODES 105

CAUTION: READ THIS BEFORE OPERATING YOUR UNIT.

1. To assure the finest performance, please read this manual carefully. Keep it in a safe place for future reference.
2. Install this unit in a cool, dry, clean place – away from windows, heat sources, sources of excessive vibration, dust, moisture and cold. Avoid sources of humming (transformers, motors). To prevent fire or electrical shock, do not expose the unit to rain or water.
3. Never open the cabinet. If something drops into the set, contact your dealer.
4. Do not use force on switches, controls or connection wires. When moving the unit, first disconnect the power plug and the wires connected to other equipment. Never pull the wires themselves.
5. The openings on the cover assure proper ventilation of the unit. If these openings are obstructed, the temperature inside the unit will rise rapidly. Therefore, avoid placing objects against these openings, and install the unit in a well-ventilated area to prevent fire and damage.
<China model only>
Be sure to allow a space of at least 20 cm behind, 20 cm on both sides and 30 cm above the top panel of the unit to prevent fire and damage.
6. The voltage used must be the same as that specified on this unit. Using this unit with a higher voltage than specified is dangerous and may result in fire or other accidents. YAMAHA will not be held responsible for any damage resulting from the use of this unit with a voltage other than that specified.
7. Digital signals generated by this unit may interfere with other equipment such as tuners, receivers and TVs. Move this unit farther away from such equipment if interference is observed.
8. Always set the VOLUME control to “∞” before starting the audio source play. Increase the volume gradually to an appropriate level after playback has been started.
9. Do not attempt to clean the unit with chemical solvents; this might damage the finish. Use a clean, dry cloth.
10. Be sure to read the “TROUBLESHOOTING” section regarding common operating errors before concluding that the unit is faulty.
11. When not planning to use this unit for a long period of time (e.g., a vacation), disconnect the AC power plug from the wall outlet.
12. To prevent lightning damage, disconnect the AC power plug and disconnect the antenna cable when there is an electrical storm.
13. Grounding or polarization – Precautions should be taken so that the grounding or polarization of the unit is not defeated.
14. AC outlet
Do not connect audio equipment to the AC outlet on the rear panel if that equipment requires more power than the outlet is rated to provide.
15. **Voltage Selector (China model only)**
The voltage selector on the rear panel of this unit must be set for your local main voltage BEFORE plugging into the AC main supply.
Voltages are 110/120/220/240 V AC, 50/60 Hz.

This unit is not disconnected from the AC power source as long as it is connected to the wall outlet, even if this unit itself is turned off. This state is called the standby mode. In this state, this unit is designed to consume a very small quantity of power.

FREQUENCY STEP switch (China model only)

Because the interstation frequency spacing differs in different areas, set the FREQUENCY STEP switch (located at the rear) according to the frequency spacing in your area. Before setting this switch, disconnect the AC power plug of this unit from the AC outlet.

IMPORTANT

Please record the serial number of this unit in the space below.

MODEL:

Serial No.:

The serial number is located on the rear of the unit. Retain this Owner's Manual in a safe place for future reference.

WARNING

**TO REDUCE THE RISK OF FIRE OR ELECTRIC SHOCK,
DO NOT EXPOSE THIS UNIT TO RAIN OR MOISTURE.**

FOR CANADIAN CUSTOMERS

To prevent electric shock, match wide blade of plug to wide slot and fully insert.

This Class B digital apparatus complies with Canadian ICES-003.

FEATURES OF THE SOUND EFFECTS

Introduction

Welcome to the exciting world of digital home entertainment. This unit is one of the most complete and advanced AV receivers available. Some of the more advanced features may not be familiar to you, but they are easy to use. State-of-the-art technologies such as Dolby Digital and Digital Theater Systems (DTS) may be new to your home, but you have probably experienced the amazing realism they bring to feature films in theaters around the world.

To make the listening experience even more enjoyable, this unit includes a number of exclusive, digitally created listening environments known as digital sound fields. Choosing a sound field program is like transporting yourself to such venues as an outdoor arena, a European church, or a cozy jazz club. Take some time now to read more about these features and enjoy the new experiences this unit brings to your home theater.

Digital Sound Field Processing

What is it that makes live music so good? Today's advanced sound reproduction technology lets you get extremely close to the sound of a live performance, but the chances are that you'll still notice something missing — the acoustic environment of the live concert hall. Extensive research into the exact nature of the sonic reflections that create the ambience of a large hall has made it possible for YAMAHA engineers to bring you this same sound to your listening room, so you'll feel all the sound of a live concert.

Furthermore, our technicians, armed with sophisticated measuring equipment, have even made it possible to capture the acoustics of a variety of actual concert halls, theaters, etc. from around the world, to allow you to accurately re-create any one of these live performance environments, all in your own home.

Dolby Pro Logic

Dolby Surround has been used in movie theaters since the mid-seventies. It has also been available in home entertainment systems since the late eighties and continues to be a popular format for home theater systems. It uses four discrete channels and five speakers to reproduce realistic and dynamic sound effects: two main channels (left and right), a center channel for dialog, and a rear channel for special sound effects. The rear channel reproduces sound within a narrow frequency range.

Most video tapes and laser discs include Dolby Surround encoding, as do many TV and cable broadcasts. The Dolby Pro Logic decoder built into this unit employs a digital signal processing system that stabilizes each channel for even more accurate sound positioning than is available with standard analog processors.

Dolby Digital

Dolby Digital is the next level of the Dolby Surround sound system that was developed for 35 mm-film movies by employing low bit-rate audio coding.

Dolby Digital is a digital surround sound system that provides completely independent multi-channel audio to you. Dolby Digital provides five full-range channels in what is sometimes referred to as a "3/2" configuration: three front channels (left, center and right), and two surround channels. A sixth bass-only effect channel is also provided for output of LFE (low frequency effect), or low bass effects that are independent of other channels. (This is called the "LFE channel".) This channel is counted as 0.1, thus giving rise to the term 5.1 channels in total.

Compared to Dolby Surround, which is referred to a "3/1" system (left front, center, right front and just one surround channel), Dolby Digital features two surround channels, called stereo or split surrounds, each offering the same full-range fidelity as the three front channels.

By using the built-in Dolby Digital decoder, you can experience the dramatic realism and impact of Dolby Digital theater sound in your home.

The wide dynamic range of sound reproduced by the five full-range channels and precise sound orientation by digital sound processing provides listeners with excitement and realism that have never been experienced before.

Dolby Digital forms 5.1 channels as already mentioned, but it can also form fewer channels, for example 2-channel stereo and monaural. You may be able to find some 2-channel stereo and/or monaural sources encoded with Dolby Digital in the market.

Laser disc and DVD are home audio/video program sources that could benefit from Dolby Digital. In the near future, Dolby Digital will also be applied to DBS, CATV and HDTV. The ongoing release of Dolby Digital theatrical films now underway will provide an immediate source of Dolby Digital encoded video software.



Manufactured under license from Dolby Laboratories. "Dolby", "Pro Logic" and the double-D symbol are trademarks of Dolby Laboratories.

DTS Digital Surround

DTS (Digital Theater Systems) was developed to replace analog soundtracks of movies with six discrete channels of digital soundtracks, and it is now installed in many theaters around the world. The DTS digital playback system changed the way we experienced movies in theaters with six discrete channels of superb digital audio.

DTS technology, through intense research and development has made it possible to deliver similar encode/decode discrete technology to home audio surround-sound entertainment. DTS Digital Surround is an encode/decode system which delivers six channels of master-quality, 20-bit audio; technically, it is 5.1 channels, which means 5 full-range (left, center, right and two surround) channels, plus a subwoofer (LFE) channel (as "0.1"). It is compatible with the 5.1 speaker configurations that are currently available for home theater systems.

The DTS Digital Surround algorithm is designed to encode the six channels of 20-bit audio on to some laser discs, compact discs and DVDs with considerably less data compression.

By using the DTS decoder built into this unit, you can experience the dramatic realism and impact of the DTS-installed theater's high quality sound in your home.

Laser disc, compact disc and DVD are home audio formats by which DTS can present its high-quality multi-channel audio. (In addition to movies on laser discs, many exciting new multi-channel music recordings will also become available in the form of DTS-encoded compact discs.)



Manufactured under license from Digital Theater Systems, Inc. US Pat. No. 5,451,942 and other world-wide patents issued and pending. "DTS", "DTS Digital Surround", are trademarks of Digital Theater Systems, Inc. Copyright 1996 Digital Theater Systems, Inc. All Rights Reserved.

CINEMA DSP: Dolby Surround + DSP / DTS + DSP

The Dolby Surround sound and DTS systems show their full ability in a large movie theater, because movie sounds are originally designed to be reproduced in a large movie theater that uses a multitude of speakers. Trying to create a sound environment similar to that of a movie theater in your home is difficult because of the room size, material inside the walls, the number of speakers, and so on. In other words, your listening room is very different from a movie theater.

However, YAMAHA DSP technology allows you to create nearly the same sound experience as that of a large movie theater in your home by compensating for the lack of presence and dynamics in the listening room with original digital sound fields combined with Dolby Surround or DTS Digital Surround sounds.

CINEMA DSP

The YAMAHA "CINEMA DSP" logo indicates those programs that are created by the combination of YAMAHA DSP technology and Dolby Surround or DTS.

Dolby Pro Logic + 2 Digital Sound Fields

Digital sound fields are created on the presence side and the rear surround side of the Dolby Pro Logic-decoded sound field, respectively. They create a wide acoustic environment and emphasize the surround effect in the room, letting you feel as much presence as if you were watching a movie in a popular Dolby Stereo theater.

Refer to pages 36 to 37 for the DSP program.

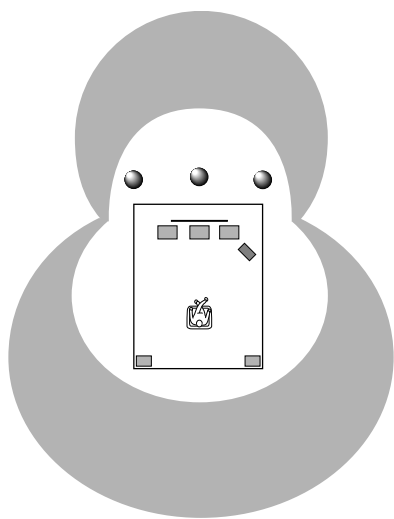

Dolby Digital or DTS + 3 Digital Sound Fields

Digital sound fields are created on the presence side and the independent left and right surround sides of the Dolby Digital-decoded or DTS-decoded sound field, respectively. They create a wide acoustic environment and strong surround effect in the room without losing high-channel separation. With the wide dynamic range of Dolby Digital or DTS sound, this sound field combination lets you feel as if you were watching a movie in the newest Dolby Digital theater or DTS-installed theater. This is the most ideal home theater sound at the present time.

Refer to pages 36 to 37 for the DSP program.

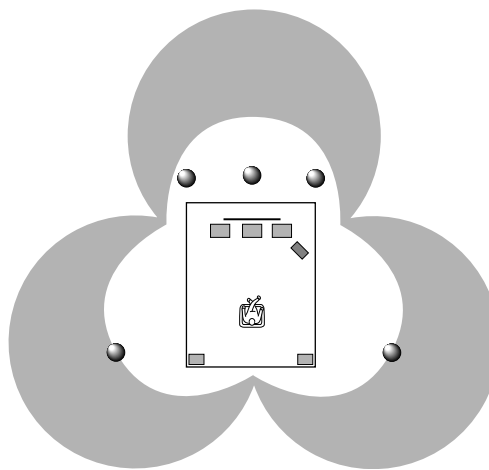

CONTROLS AND THEIR FUNCTIONS

FRONT PANEL

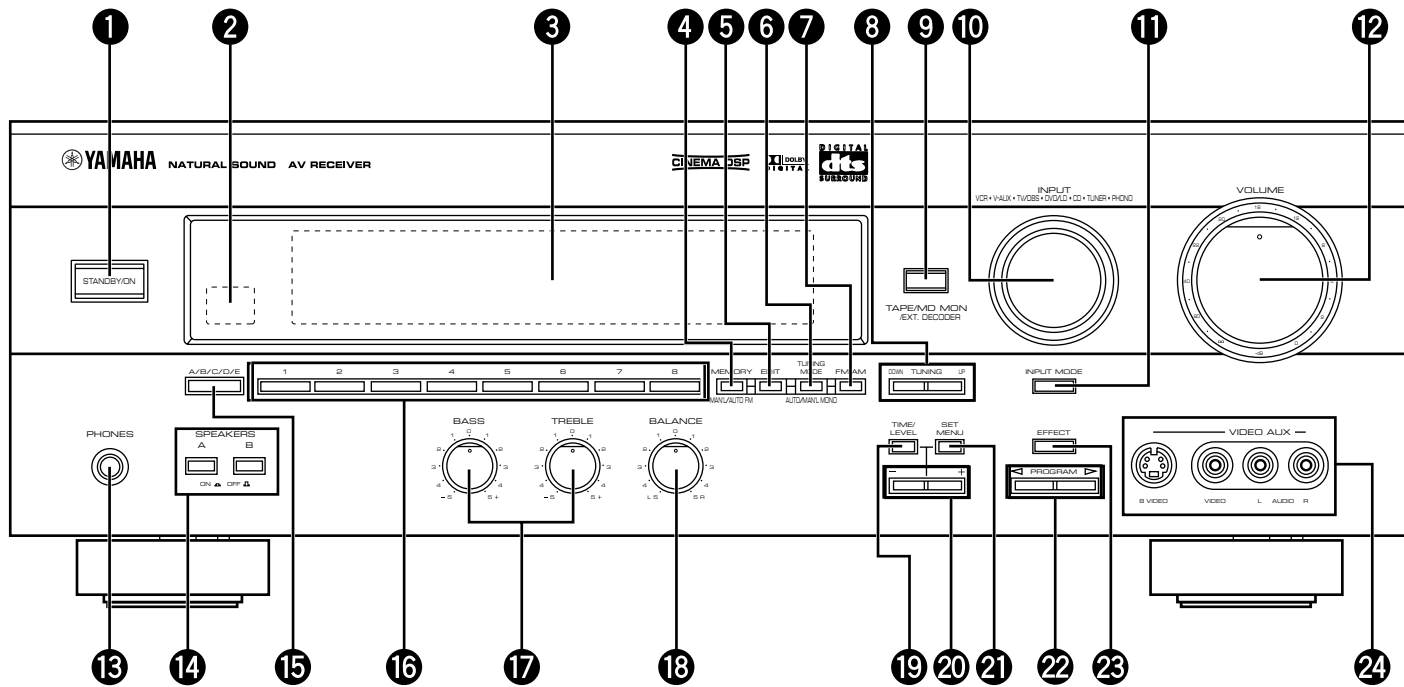

Refer to pages 43 to 48 for the remote control.

1 STANDBY/ON

Press this switch to turn on the power of this unit. Press it again to set this unit in the standby mode.

Standby mode

In this state, this unit consumes a very small quantity of power to receive infrared-signals from the remote control.

2 Remote control sensor

This receives signals from the remote control.

3 Display

This shows various information. (Refer to page 12 for details.)

4 MEMORY (MAN'L/AUTO FM)

Press this button to store the broadcasting stations. When this button is pressed and held for more than three seconds, automatic preset tuning begins.

5 EDIT

This button is used to exchange the assignment of two preset stations with each other.

6 TUNING MODE (AUTO/MAN'L MONO)

Press this button to switch the tuning mode to automatic or manual. To select the automatic tuning mode, press this button so that the "AUTO TUNING" indicator lights up on the display. To select the manual tuning mode, press this button so that the "AUTO TUNING" indicator goes off.

7 FM/AM

Press this button to switch the reception band between FM and AM.

8 TUNING UP/DOWN

This button is used for tuning. Press the UP side to tune in to higher frequencies, and press the DOWN side to tune in to lower frequencies.

9 TAPE/MD MON / EXT. DECODER

Press this button to play a tape or an MD. The "TAPE/MD MON" indicator lights up on the display. When you press the button next, the "TAPE/MD MON" indicator goes off, "EXT. DECDR" appears on the display and you can play the signal connected to the **EXTERNAL DECODER INPUT** terminals.

10 INPUT

Turn this selector to select the input source (VCR, VIDEO AUX, TV/DBS, DVD/LD, CD, TUNER, PHONO) that you want to listen to or watch.

The name of the selected input source appears on the display.

11 INPUT MODE

This button switches between the DVD/LD and TV/DBS input signal modes.

12 VOLUME

This control is used to raise or lower the volume level.

13 PHONES jack

When you use headphones, connect the headphones to the **PHONES** jack. You can listen to the sound to be output from the main speakers through the headphones.

When using headphones only, set both **SPEAKERS A** and **B** to the OFF position and switch off the digital sound field processor (so that no DSP program name appears on the display) by pressing **EFFECT**.

14 SPEAKERS

Set **A** or **B** (or both **A** and **B**) to the ON position for the main speaker system (connected to this unit) that you want to use. Set the button(s) for the main speaker system you don't want to use to the OFF position.

15 A/B/C/D/E

Press this button to select one of a group (A to E) of preset stations.

16 Preset station number selector

Each of these buttons selects a preset station number (1 to 8).

17 Tone controls

These controls are only effective for the sound from the main speakers.

BASS

Use this control to increase or decrease the low-frequency response. The "0" position produces a flat response.

TREBLE

Use this control to increase or decrease the high-frequency response. The "0" position produces a flat response.

18 BALANCE

This control is only effective for the sound from the main speakers.

Turn the control to adjust the balance of the output volume to the left and right speakers to compensate for sound imbalance caused by the speaker location or listening room conditions.

19 TIME/LEVEL

Press this button to select the item in the TIME/LEVEL mode.

20 +/-

These buttons are used to adjust the settings of the SET MENU mode and the TIME/LEVEL mode. In the TIME/LEVEL mode, press **+** to increase the delay time or speaker output level. Press **-** to decrease the delay time or speaker output level.

21 SET MENU

Press this button to select functions in the SET MENU mode.

22 PROGRAM selector

Press **<** or **>** to select a DSP program. The name of the selected program appears on the display.

23 EFFECT

Press this button once to switch the effect speakers (center and rear) on or off. If you turn off the effect by using **EFFECT**, all Dolby Digital and DTS audio signals are directed to the main left and right channels. In that case, the left and right channel signal levels may not match.

24 VIDEO AUX terminals

Connect an auxiliary video or audio input source such as a camcorder to these terminals. If the connected video unit has an S video output terminal, connect it to the **S VIDEO** terminal to obtain a high-resolution picture. The source connected to these terminals can be selected by **INPUT**.

DISPLAY PANEL

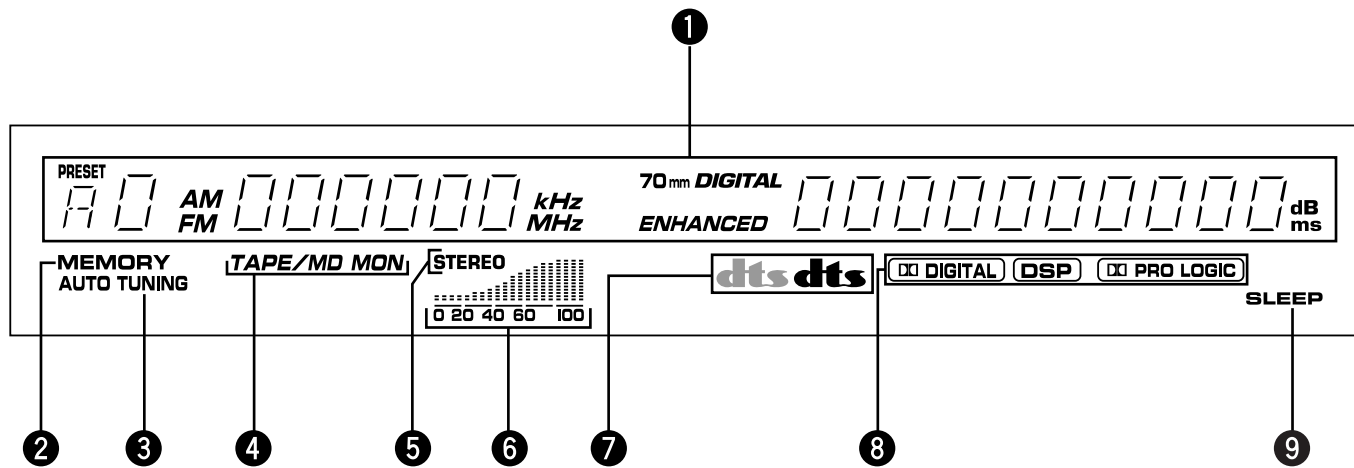

1 Multi-information display

This displays various information, for example the station frequency, preset station number and name of the selected input source.

2 MEMORY indicator

When **MEMORY** is pressed, this indicator flashes for about five seconds. During this period, the displayed station can be stored in the memory.

3 AUTO TUNING indicator

This lights up when the unit is in the automatic tuning mode.

4 TAPE/MD MON indicator

This lights up when the tape deck (or MD recorder, etc.) is selected as the input source by pressing **TAPE/MD MON / EXT. DECODER** on the front panel or **TAPE/MD** on the remote control.

5 STEREO indicator

This lights up when an FM stereo broadcast with sufficient signal strength is being received.

6 Signal-level indicator

This indicates the signal level of the station being received. If multipath interference is detected, the indication decreases.

7 dts indicators

Either “dts” indicator lights up when the built-in DTS decoder is turned on.

The red “dts” indicator lights up when playing a CD or LD encoded with DTS.

The orange “dts” indicator lights up when playing a DVD encoded with DTS.

* An orange “dts” indicator may light up when playing a CD or LD encoded with DTS after playing a video-CD or DVD on a DVD/LD combi-player.

8 DIGITAL, DSP and PRO LOGIC indicators

“DIGITAL” lights up when the built-in Dolby Digital decoder is on and the signals of the selected source encoded with Dolby Digital are not in 2-channel. “DSP” lights up when the built-in digital sound field processor is on, and “PRO LOGIC” lights up when the built-in Dolby Pro Logic decoder is on. Depending on the selected DSP program, both “DIGITAL” and “DSP”, or both “DSP” and “PRO LOGIC” will light up.

9 SLEEP indicator

This lights up while the built-in SLEEP timer is functioning.

SPEAKER SETUP

SPEAKERS TO BE USED

This unit is designed to provide the best sound-field quality with a 5-speaker configuration, using main speakers, rear speakers and a center speaker.

The main speakers are used for the main source sound plus the effect sounds. They will probably be the speakers from your present stereo system. The rear speakers are used for the effect and surround sounds, and the center speaker is for the center sounds (dialog, vocals, etc.). If for some reason it is not practical to use a center speaker, you can do without it. Best results, however, are obtained with the full system.

The main speakers should be high-performance models and have enough power-handling capacity to accept the maximum output of your audio system.

The other speakers do not have to be equal to the main speakers. For precise sound localization, however, it is ideal to use high-performance models that can reproduce sounds over the full range for the center speaker and the rear speakers.

Use of a subwoofer expands your sound field

It is also possible to further expand your system with the addition of a subwoofer. The use of a subwoofer is effective not only for reinforcing bass frequencies from any or all channels, but also for reproducing the LFE (low frequency effect) sound with high fidelity when playing back a source that is Dolby Digital or DTS-decoded. The YAMAHA Active Servo Processing Subwoofer System is ideal for natural and lively bass reproduction.

SPEAKER PLACEMENT

Refer to the following diagram when you place the speakers.

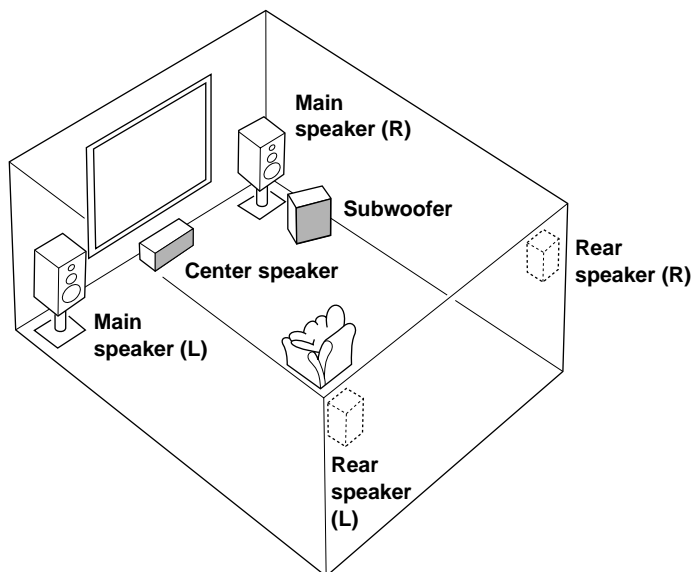

Main: The position of your present stereo speaker system.

Rear: Behind your listening position, facing slightly inward. Nearly 1.8 m (approx. 6 feet) up from the floor.

Center: Precisely between the main speakers. (To avoid interference with TV sets, use a magnetically shielded speaker.)

Subwoofer: The position of the subwoofer is not as critical, because low bass tones are not highly directional.

Note: If the center speaker (principally, it reproduces dialog, vocals, etc.) is not used, the sound will be output from the left and right main speakers. In that case, be sure to select the NONE position for "CNTR" in the SET MENU mode. (See page 21 for details.)

CONNECTIONS

Never plug in this unit and other components until all connections have been completed.

CONNECTIONS WITH OTHER COMPONENTS

Use RCA-type pin plug cables for connecting audio/video components with the exception described later.

When making connections between this unit and other components, be sure all connections are made correctly, that is to say L (left) to L, R (right) to R, “+” to “+” and “-” to “-”. Also, refer to the owner’s manual for each component to be connected to this unit.

* If you have YAMAHA components numbered as 1, 3, 4, etc. on the rear panel, connections can be made easily by making sure to connect the output (or input) terminals of each component to the same-numbered terminals of this unit.

*¹ AC OUTLET(S) (SWITCHED)

U.S.A., Canada and China models 2 OUTLETS
Australia model 1 OUTLET

Use these to connect the power cords from your components to this unit.

The power to the **AC OUTLET(S)** is controlled by this unit’s **STANDBY/ON** or the provided remote control’s **POWER** and **STANDBY**. These outlets will supply power to any connected component whenever this unit is turned on.

The maximum power (total power consumption of components) that can be connected to the **AC OUTLET(S)** is 100 watts.

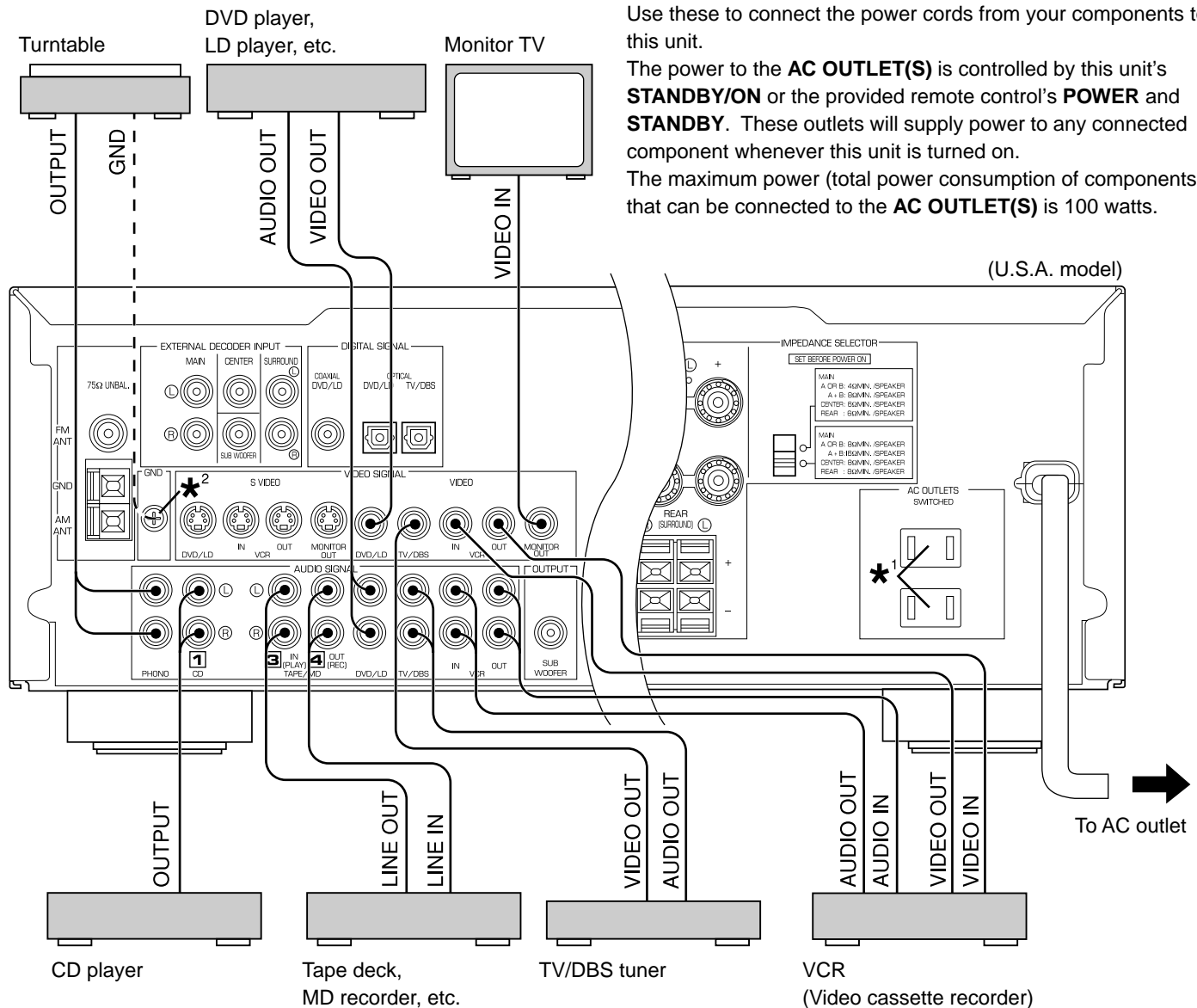

*² GND terminal (for turntable use)

Connecting the ground (earth) wire of the turntable to the **GND** terminal will normally minimize hum, but in some cases, better results may be obtained with the ground wire disconnected.

CONNECTING TO DIGITAL (COAXIAL AND/OR OPTICAL) TERMINALS

If your DVD (LD) player, TV/DBS tuner, etc. are equipped with coaxial or optical digital audio signal output terminals, they can be connected to this unit's **COAXIAL** and/or **OPTICAL** digital signal input terminals.

Digital audio signals are transmitted with less loss than analog audio signals. In addition, digital audio signal connections are necessary, especially for an LD player or a DVD player, to send signals encoded with Dolby Digital or DTS to this unit.

To make a connection between optical digital audio signal terminals, remove the cover from each terminal, and then connect them by using a commercially available optical fiber cable that conforms to EIAJ standards. Other cables might not function correctly.

Even if you connect an audio/video unit to the **COAXIAL** (or **OPTICAL**) terminal of this unit, you must keep the unit connected with the same-named analog audio signal terminals of this unit, because a digital signal cannot be recorded by a tape deck, MD recorder or VCR connected to this unit. You can easily switch the selection of input signals between "digital" and "analog." (See page 28 for details.)

Notes

- When connecting an audio/video unit to both the digital and analog terminals of this unit, make sure to connect between both terminals of the same name.
- Be sure to attach the covers when the **OPTICAL** terminals are not being used in order to protect them from dust.
- The input signal from the DVD/LD input terminals is selected in the following order of priority with the input mode set to the AUTO position:
 - 1 **COAXIAL** terminal
 - 2 **OPTICAL** terminal
 - 3 Analog terminal
- If the DIGITAL OUT data of the player has been processed in any way, you may not be able to perform DTS playback even if you make a digital connection between this unit and the player.
- All digital audio signal input terminals are applicable to sampling frequencies of 32 kHz, 44.1 kHz and 48 kHz.

No sound will be generated when connecting your LD player's Dolby Digital RF signal output terminal directly to this unit's **COAXIAL DVD/LD** digital signal input terminal.

DVD or LD player*

* If your LD player has a Dolby Digital RF signal output terminal, be sure to use the RF demodulator (separately purchased).

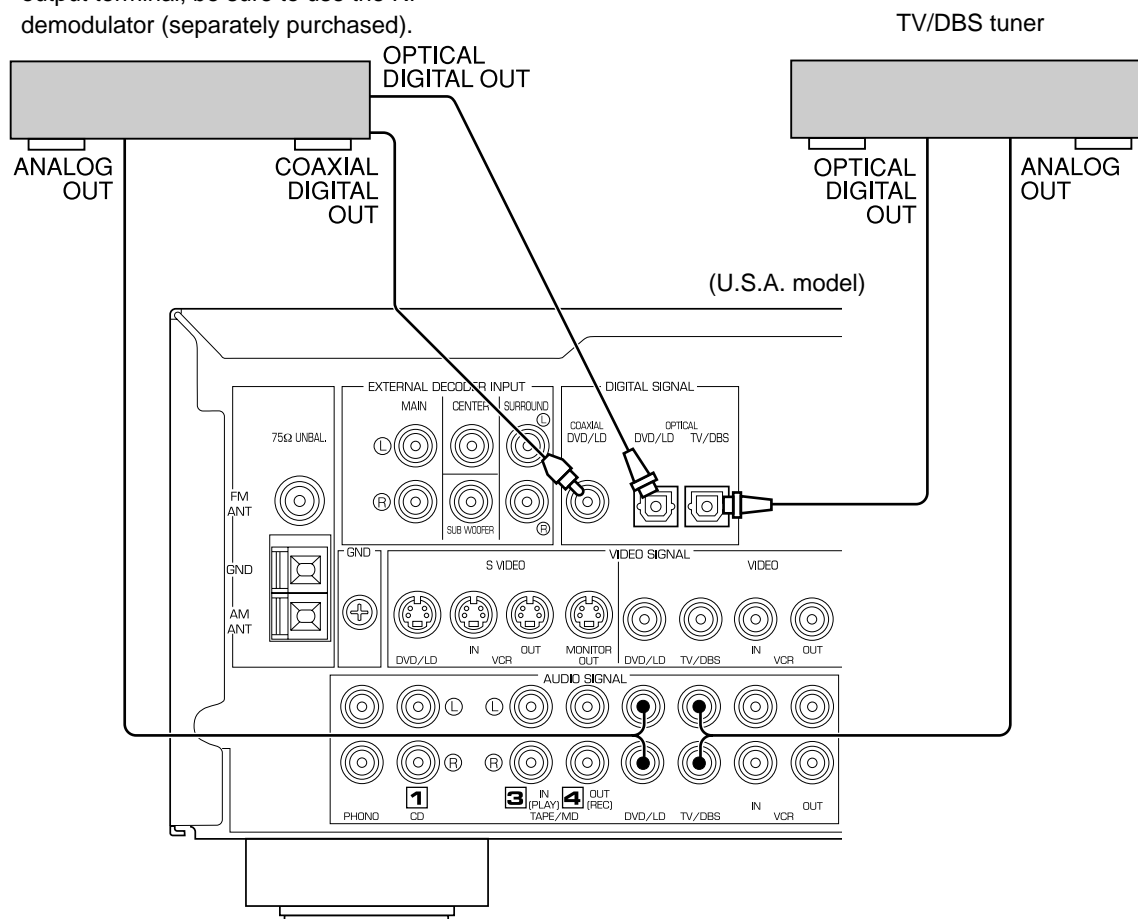

CONNECTING TO S VIDEO TERMINALS

If you have a VCR and a monitor equipped with “S” (high-resolution) video terminals, those terminals can be connected to this unit’s **S VIDEO** terminals. Connect the VCR’s “S” video input and output terminals to this unit’s **S VIDEO VCR OUT** and **IN** terminals, respectively, and connect the monitor’s “S” video input terminal to this unit’s **S VIDEO MONITOR OUT** terminal. Otherwise, connect the VCR’s composite video terminals to this unit’s composite video terminals, and connect the monitor’s composite video input terminal to this unit’s composite **MONITOR OUT** terminal.

In addition, if you have a DVD or LD player equipped with an “S” video terminal, connect the DVD/LD player’s “S” video output terminal to this unit’s **S VIDEO DVD/LD** terminal.

Note

If video signals are sent to both **S VIDEO** input and composite input terminals, the signals will be sent to their respective output terminals.

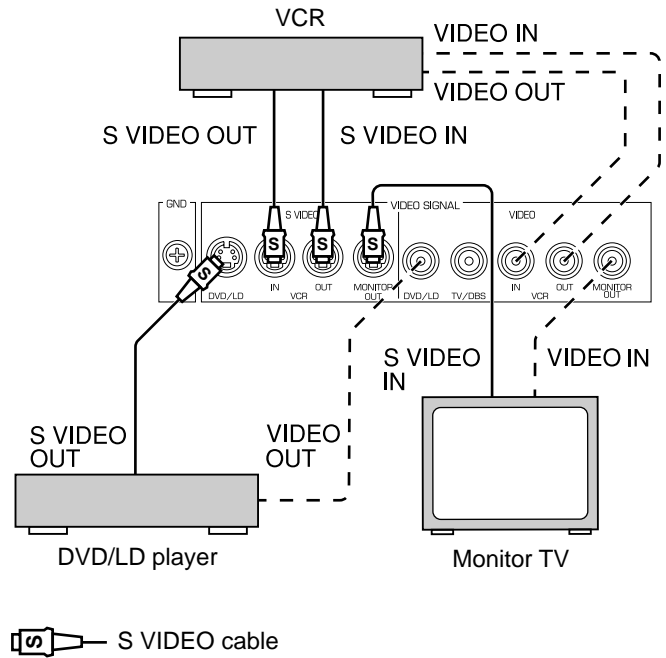

S VIDEO terminals

This unit provides you with **S VIDEO** terminals in addition to standard VIDEO terminals.

S VIDEO terminals transmit video signals separated into luminance (Y) signals and color (C) signals. In comparison with **S VIDEO** terminals, standard VIDEO terminals transmit “composite” video signals.

CONNECTING TO VIDEO AUX TERMINALS (ON THE FRONT PANEL)

These terminals are used to connect any video input source such as a camcorder to this unit.

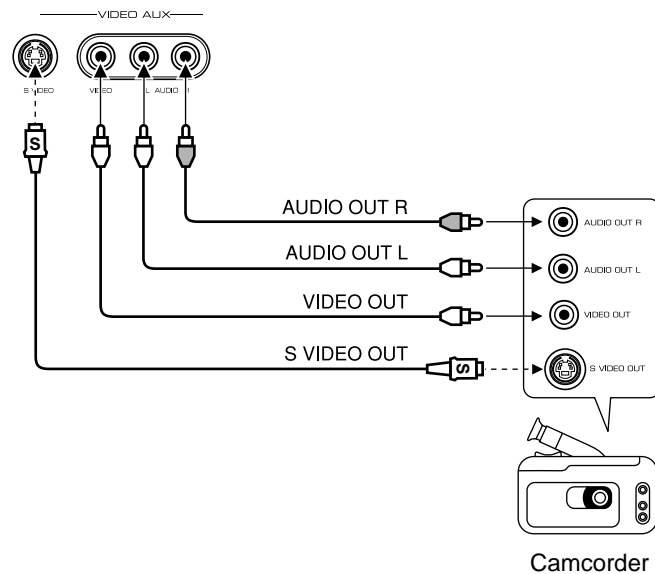

CONNECTING TO AN EXTERNAL DECODER

This unit is equipped with additional 6-channel audio signal input terminals for inputting signals from an external decoder to this unit.

Connect the 6-channel audio signal output terminals of the decoder to the **EXTERNAL DECODER INPUT** terminals of this unit.

Notes

- When signals input to these terminals are selected, the digital sound field processor cannot be used.
- The settings of “CNTR”, “REAR”, “MAIN” and “BASS” in the SET MENU mode have no effect on the signals input to these terminals. The setting of “M.LVL” is effective. (Refer to page 21 for details.)
- Adjustment of the output level of the center speakers, rear speakers and subwoofer is effective when the signals input to these terminals are selected as the input source. (Refer to page 39 for details.)

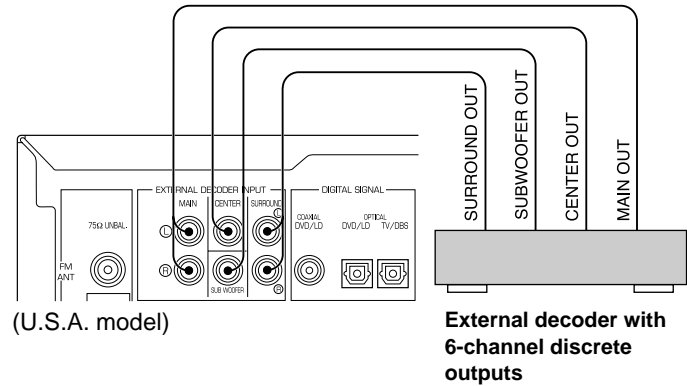

IMPEDANCE SELECTOR SWITCH

WARNING

Do not change the **IMPEDANCE SELECTOR** switch setting while the power to this unit is on, otherwise this unit may be damaged.

If this unit fails to turn on when the STANDBY/ON switch is pressed, the **IMPEDANCE SELECTOR** switch may not be fully set to either end. If so, set the switch to either end fully when this unit is in the standby mode.

IMPEDANCE SELECTOR

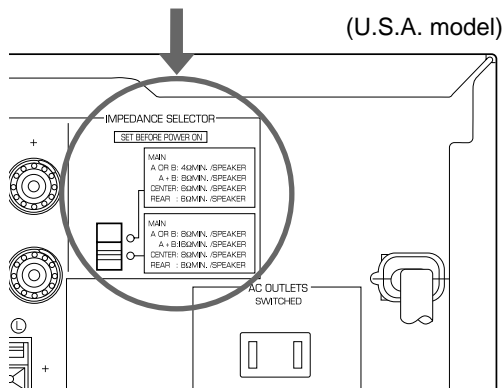

Select the position whose requirements your speaker system meets.

 (Upper position)

Main: If you use one pair of main speakers, the impedance of each speaker must be 4 Ω or higher.

If you use two pairs of main speakers, the impedance of each speaker must be 8 Ω or higher.

Center: The impedance of the speaker must be 6 Ω or higher.

Rear: The impedance of each speaker must be 6 Ω or higher.

 (Lower position)

Main: If you use one pair of main speakers, the impedance of each speaker must be 8 Ω or higher.

If you use two pairs of main speakers, the impedance of each speaker must be 16 Ω or higher.

<Canada model only>

The impedance of each speaker must be 8 Ω or higher.

Center: The impedance of the speaker must be 8 Ω or higher.

Rear: The impedance of each speaker must be 8 Ω or higher.

CONNECTING SPEAKERS

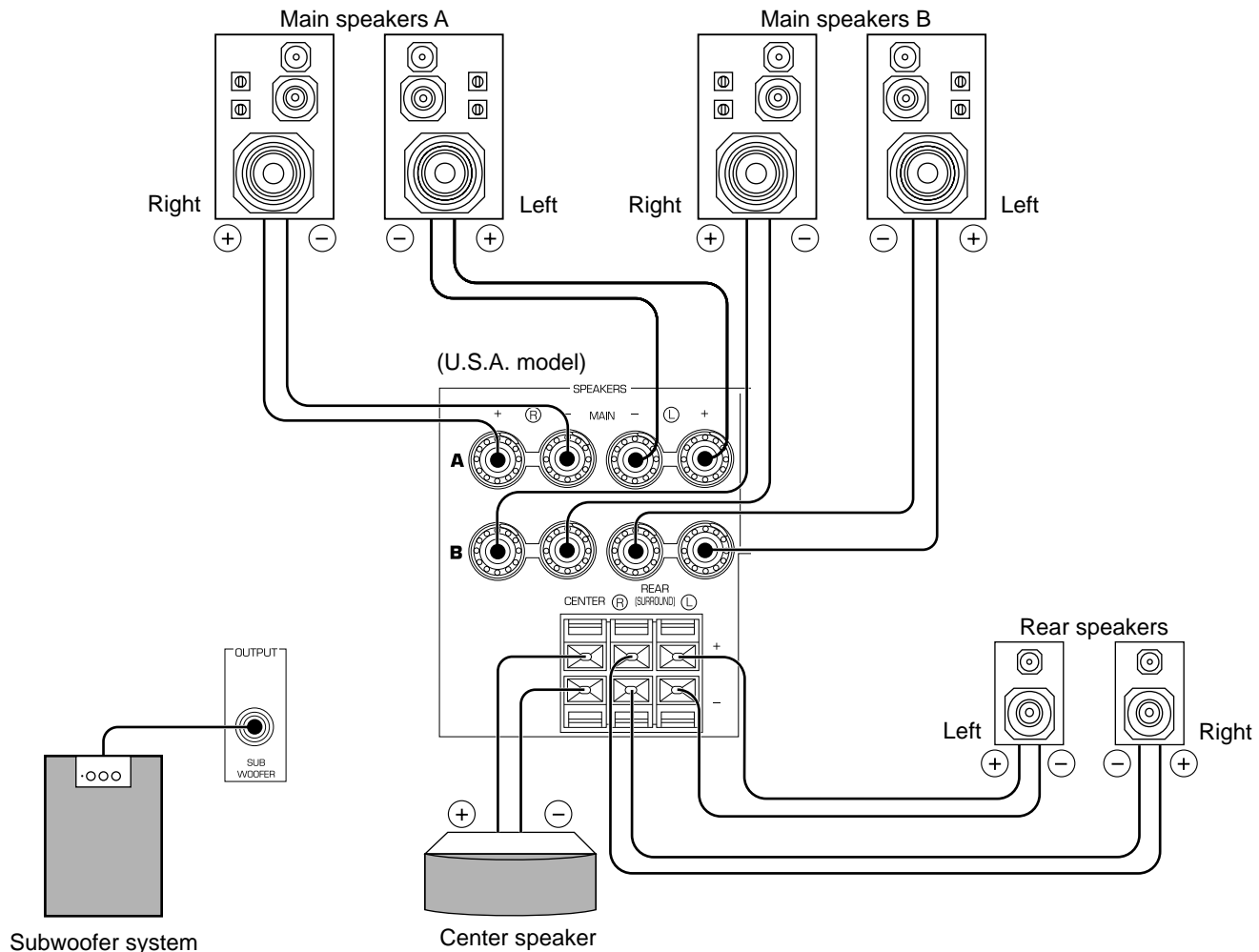

Note

Use speakers with the specified impedance shown on the rear panel of this unit.

Main speaker connections

One or two speaker systems can be connected to this unit. If you use only one speaker system, connect it to either of the **SPEAKERS A** or **B** terminals.

Rear speaker connections

A rear speaker system can be connected to this unit. Place them to the rear of your listening position.

Center speaker connection

A center speaker can be connected to this unit. Place it on or under the TV.

Subwoofer connection

You may wish to add a subwoofer to reinforce low frequencies or to output low bass sound from the subwoofer channel. If you have a subwoofer with built-in amplifier, including the YAMAHA Active Servo Processing Subwoofer System, connect the **SUBWOOFER OUTPUT** terminal of this unit to the input terminal of the subwoofer system.

How to connect

Connect the **SPEAKERS** terminals to your speakers with wire of the proper gauge, cut as short as possible. If the connections are faulty, no sound will be heard from the speakers. Make sure that the polarity of the speaker wires is correct, that is the + and – markings are observed. If these wires are reversed, the sound will be unnatural and lack bass.

Caution

Do not let the bare speaker wires touch each other and do not let them touch any metal part of this unit. This could damage the unit and/or speakers.

Connecting to the MAIN SPEAKERS terminals

Red: positive (+)
Black: negative (–)

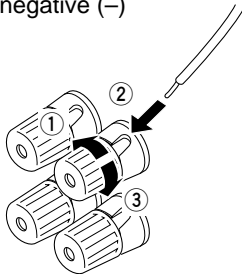

- ① Unscrew the knob.
- ② Remove approx. 5 mm (1/4") of insulation from each of the speaker wires and insert one bare wire into each terminal.
- ③ Tighten the knob to secure the wire.

Connecting to the REAR and CENTER SPEAKERS terminals

Red: positive (+)
Black: negative (–)

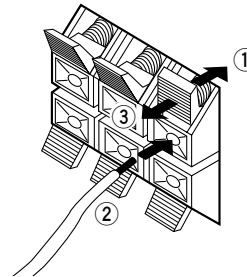

- ① Press the tab.
- ② Remove approx. 5 mm (1/4") of insulation from each of the speaker wires and insert one bare wire into each terminal.
- ③ Release the tab to secure the wire.

Banana plug connections are also possible. Simply insert the banana plug connector into the corresponding terminal.

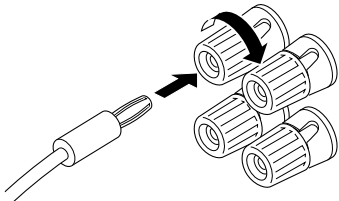

ANTENNA CONNECTIONS

Each antenna should be correctly connected to the designated terminals, referring to the following diagram. Both AM and FM indoor antennas are included with this unit. In general, these antennas will probably provide sufficient signal strength. Nevertheless, a properly installed outdoor antenna will give clearer reception than an indoor one. If you experience poor reception quality, an outdoor antenna may result in improvement.

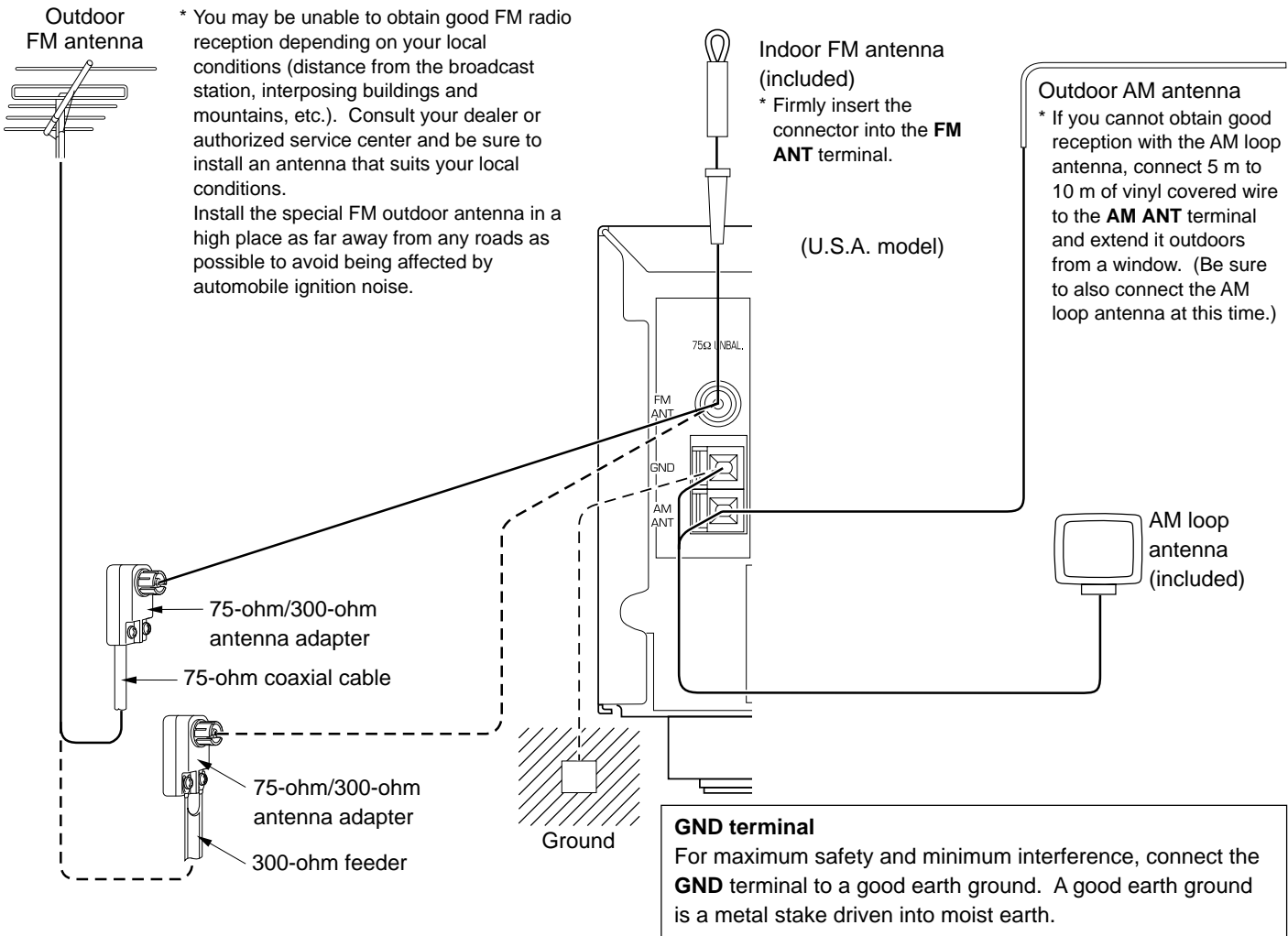

Connecting the AM loop antenna

- 1**
 - ① Press the tab and unlock the terminal hole.
 - ② Connect the AM loop antenna lead wires to the **AM ANT** and **GND** terminals.
 - ③ Return the tab to its original position to lock the lead wires. Lightly pull the lead wires to confirm a good connection.
- 2** Attach the loop antenna to the antenna stand.
- 3** Orient the AM loop antenna so that the best reception is obtained.

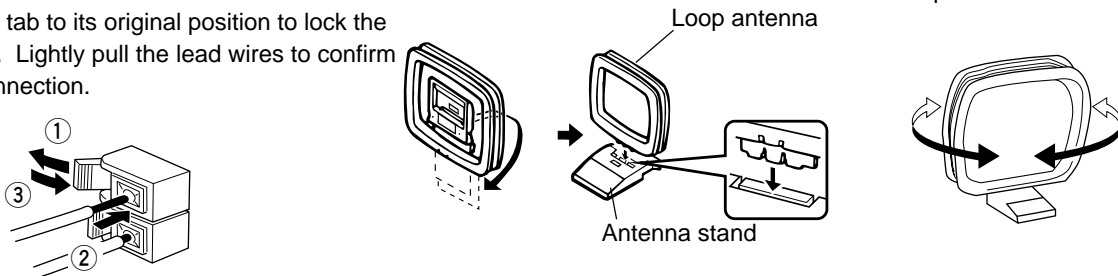

- The AM loop antenna should be placed away from this unit. The antenna may be hung on a wall.
- The AM loop antenna should always be connected, even if an outdoor AM antenna is connected to this unit.

ADJUSTMENTS BEFORE USING THIS UNIT

SELECTING THE OUTPUT MODES

This unit provides you with the following five functions to determine the method of distributing output signals to speakers suitable for your audio system. When speaker connections have all been completed, select the proper setting for each function to make the best use of your speaker system. (See "ADJUSTMENTS IN THE 'SET MENU' MODE" on page 41.)

1. **CNTR (CENTER SPEAKER)** 2. **REAR (REAR SPEAKERS)** 3. **MAIN (MAIN SPEAKERS)**
 4. **BASS (LFE/BASS OUT)** 5. **M.LVL (MAIN LEVEL)**

DESCRIPTION OF EACH FUNCTION

CNTR (CENTER SPEAKER)

Choices: LARGE/SMALL/NONE

Preset position: LARGE

- LARGE:** Select this position when your center speaker is approximately the same size as the main speakers.
- SMALL:** Select this position when you use a center speaker that is smaller than the main speakers.
 In this position, low bass signals (below 90 Hz) on the center channel are output from the main speakers (or the **SUBWOOFER OUTPUT** terminal if the SMALL position is selected for "MAIN" and the SW position is selected for "BASS").
- NONE:** Select this position when you do not have a center speaker (four speaker system). The center channel sound will be output from the left and right main speakers.

REAR (REAR SPEAKERS)

Choices: LARGE/SMALL

Preset position: LARGE

- LARGE:** Select this position if your rear speakers have high ability for bass reproduction, or if a subwoofer is connected in parallel to the rear speaker.
 In this position, full-range signals are output from the rear speakers.
- SMALL:** Select this position if your rear speakers do not have high ability for bass reproduction.
 In this position, low bass signals (below 90 Hz) on the rear channels are output from the **SUBWOOFER OUTPUT** terminal (or the main speakers if the MAIN position is selected for "BASS").

MAIN (MAIN SPEAKERS)

Choices: LARGE/SMALL

Preset position: LARGE

- LARGE:** Select this position if your main speakers have high ability for bass reproduction.
 In this position, full-range signals present on the main channels are output from the main speakers.
- SMALL:** Select this position if your main speakers do not have high ability for bass reproduction. However, if your system does not include a subwoofer, do not select this position.
 In this position, low bass signals (below 90 Hz) on the main channels are output from the **SUBWOOFER OUTPUT** terminal if the SW or BOTH position is selected for "BASS".

BASS (LFE/BASS OUT)

Choices: SW/MAIN/BOTH

Preset position: SW

- MAIN:** Select this position if your system does not include a subwoofer.
 In this position, full-range signals present on the main channels, signals from the LFE channel and other low bass signals that are distributed from other channels are output from the main speakers.
- SW/BOTH:**
 Select either the SW or BOTH position if your system includes a subwoofer.
 In either position, signals on the LFE channel and other low bass signals that are distributed from other channels are output from the **SUBWOOFER OUTPUT** terminal.
 When the LARGE position is selected for "MAIN", in the SW position, no signal is distributed from the main channels to the **SUBWOOFER OUTPUT** terminal; however, in the BOTH position, low bass signals from the main channels are output to both the main speakers and the **SUBWOOFER OUTPUT** terminal.

M.LVL (MAIN LEVEL)

Choices: NRML (NORMAL)/-10 dB

Preset position: NRML (NORMAL)

- NRML (NORMAL):**
 Normally select this position.
- 10 dB:** Select this position if the sound output from the main speakers is too loud and cannot be balanced with the sound output from the center and rear speakers.
 In this position, the sound output from the main speakers is attenuated.

Note

The settings of "CNTR", "REAR", "MAIN" and "BASS" have no effect on the signals input to the **EXTERNAL DECODER INPUT** terminals on the rear of this unit.

ADJUSTMENT METHOD

Adjustments should be made while watching the information on this unit's display.

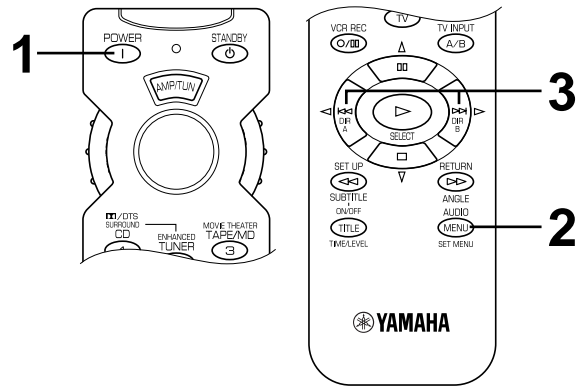
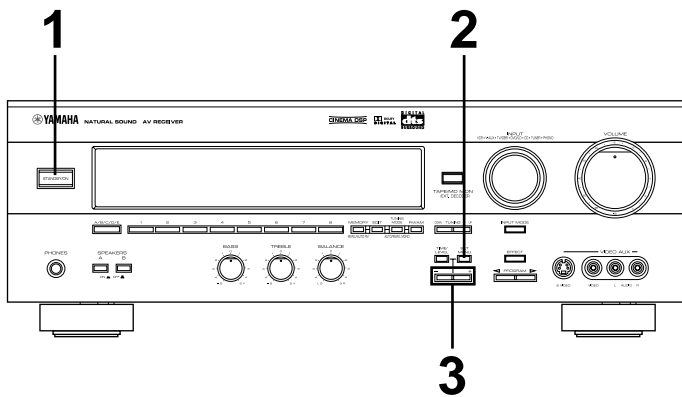

When adjusting with the remote control, set the **SELECTOR DIAL** to the **AMP/TUN** or **DSP** position on the remote control.

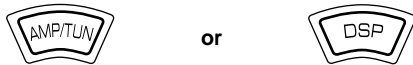

1 Turn the power on.

Front panel

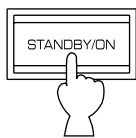

Remote control

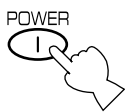

2 Press **SET MENU** once or more to select the function "CNTR" on the display.

Front panel

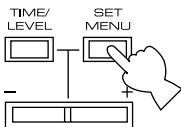

Remote control



* After pressing **SET MENU** once on the remote control, you can also select the function by pressing ∇ . (Pressing Δ goes back one selection.)



3 Press **+** or **-** once or more to select the setting you want.

Front panel

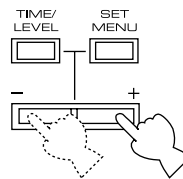

Remote control

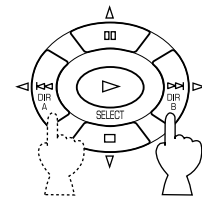

CNTR>SMALL

4 Repeat steps 2 and 3 to change the settings for "REAR", "MAIN", "BASS" and/or "M.LVL" in the same way.

SPEAKER BALANCE ADJUSTMENT

This procedure lets you adjust the sound output level balance between the main, center and rear speakers by using the built-in test tone generator. When this adjustment is performed, the sound output level heard at the listening position will be the same from each speaker. This is important for the best performance of the digital sound field processor, the Dolby Digital decoder, the Dolby Pro Logic decoder and the DTS decoder.

The adjustment of each speaker output level should be done at your listening position with the remote control. After completing the adjustment of the output level for each speaker, use VOLUME (^ v) on the remote control at your listening position to check if the adjustments are satisfactory.

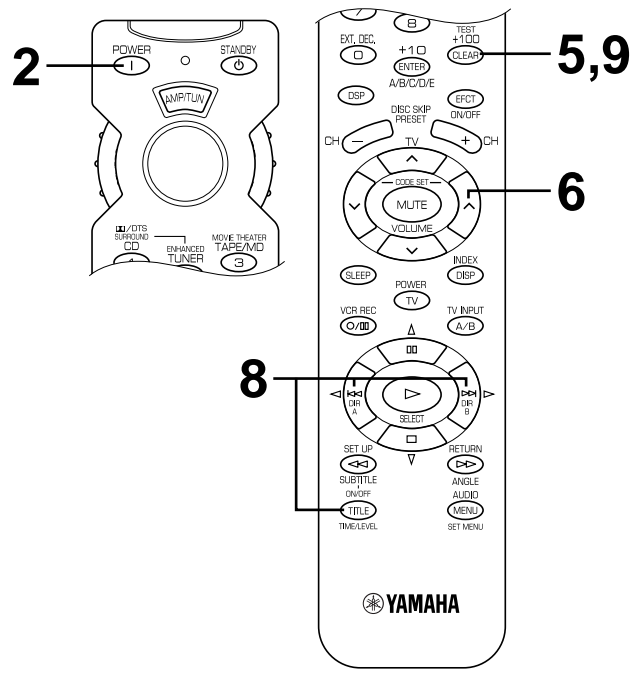
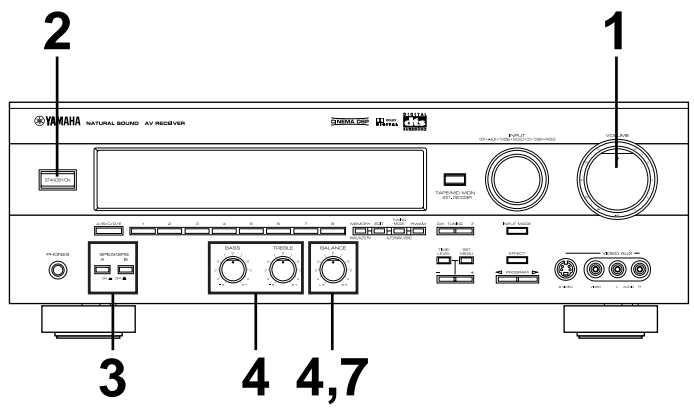

Set the SELECTOR DIAL to the AMP/TUN or DSP position on the remote control.

2 Turn the power on.

Front panel

Remote control

1 Set **VOLUME** to the “∞” position.

Front panel

3 Select the main speakers to be used.

Front panel

* If you use two main speaker systems, press both **A** and **B**.

4 Set **BASS**, **TREBLE** and **BALANCE** to the "0" position.

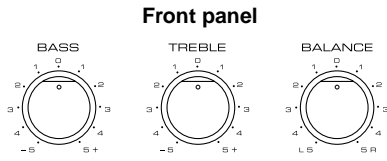

5 Press **TEST** so that "TEST LEFT" appears on the display.

Remote control

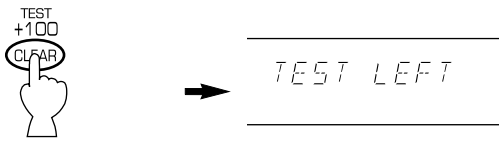

6 Turn up the volume.

Remote control

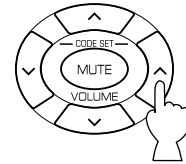

You will hear a test tone (like pink noise) from each speaker for about two seconds in following order: left main speaker, center speaker, right main speaker, right rear speaker and left rear speaker. The display changes as shown below.

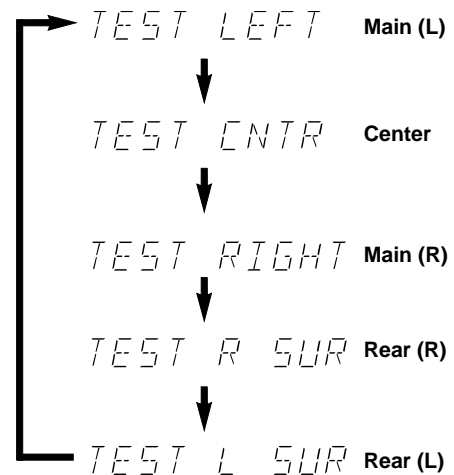

* If the function "CNTR" in the SET MENU mode is set to the NONE position, you will hear the center channel test tone from the left and right main speakers.

7 Adjust **BALANCE** so that the sound output level of the left main speaker and the right main speaker is the same.

Front panel

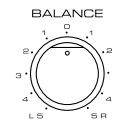

8 Adjust the sound output levels of the center speaker and the rear speakers so that they become almost the same as that of the main speakers.

Press **TIME/LEVEL** once or more to select the speaker to be adjusted so that "CENTER", "R SUR." or "L SUR." appears on the display.

Remote control



* You cannot adjust the delay time while the test tone is sounding even if "DELAY" appears on the display after pressing **TIME/LEVEL** once or more.

Adjust the level.

- * Pressing > raises and < lowers the level.
- * While adjusting, the test tone is heard from the selected speaker.

Remote control

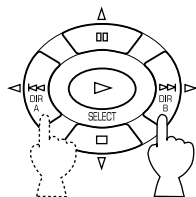

9 When the adjustment is finished, press **TEST** again to stop the test tone.

Remote control

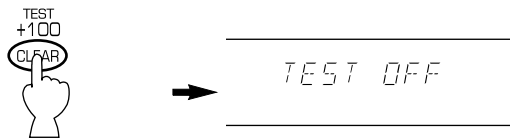

Notes

- Once you have completed these adjustments, you can only adjust the overall sound level of your audio system by using **VOLUME** (or **VOLUME** (^ v) on the remote control).
- If you use external power amplifiers, you may also use their volume controls to achieve the proper balance.
- If the function "CNTR" in the SET MENU mode is set to the NONE position, the sound output level of the center speaker cannot be adjusted in step 8. The center sound is automatically output from the left and right main speakers.
- If there is insufficient sound output from the center and rear speakers, you may decrease the main speaker output level by setting "M.LVL" to "-10 dB".

BASIC OPERATION

TO PLAY A SOURCE

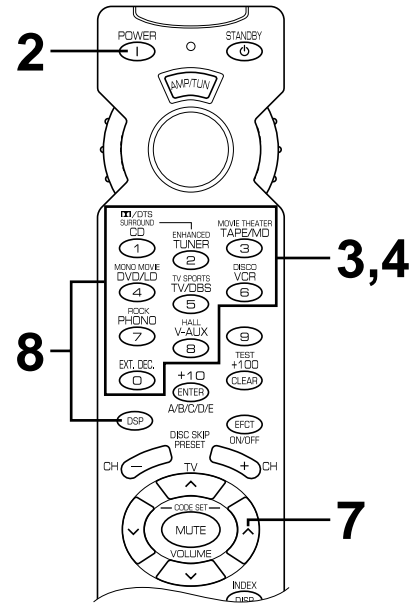
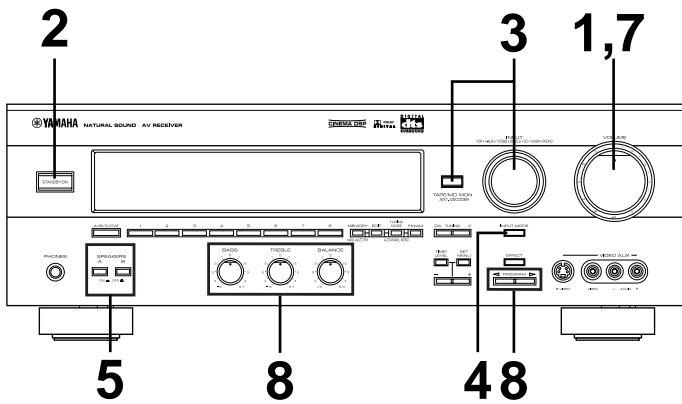

When using the remote control

- Set the SELECTOR DIAL to the AMP/TUN position on the remote control.
- To operate the CD player, DVD/LD player, tape deck, MD recorder, or other components with this remote control, set the SELECTOR DIAL to the component to be used. (See "SETUP CODES" on page 49.)

1 Set **VOLUME** to the "∞" position.

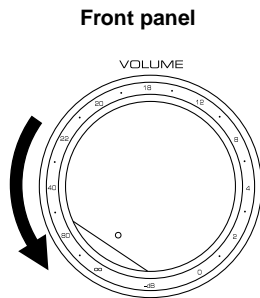

2 Turn the power on.

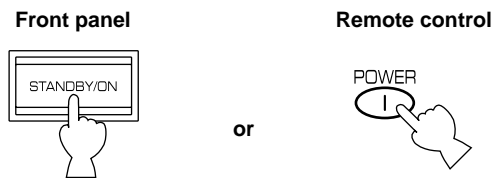

3 Select the desired input source by using **INPUT**. (Turn on the monitor TV for video sources.)

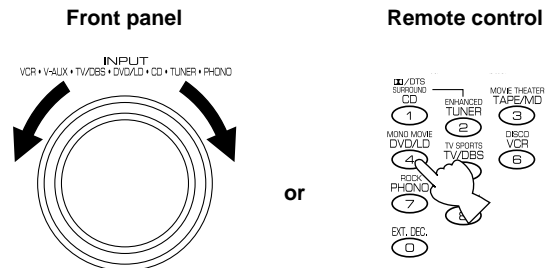

The name of the selected input source will appear on the display.

To play a tape or an MD

Press **TAPE/MD MON / EXT. DECODER** on the front panel or **TAPE/MD** on the remote control so that the "TAPE/MD MON" indicator lights up on the display.

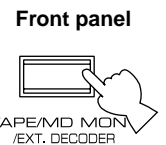

To use a decoder connected to the EXTERNAL DECODER INPUT terminals

Press **TAPE/MD MON / EXT. DECODER** once or more on the front panel or **EXT. DEC.** on the remote control so that "EXT. DECDR" appears on the display.

- 4** For a DVD/LD or TV/DBS source, the current input mode is also shown.
- * To change the input mode for the DVD/LD or TV/DBS source, press **INPUT MODE** (or the button that you have pressed to select the input source in step 3 on the remote control) once or more until the desired input mode is shown on the display. (See page 28 for details on switching the input mode.)

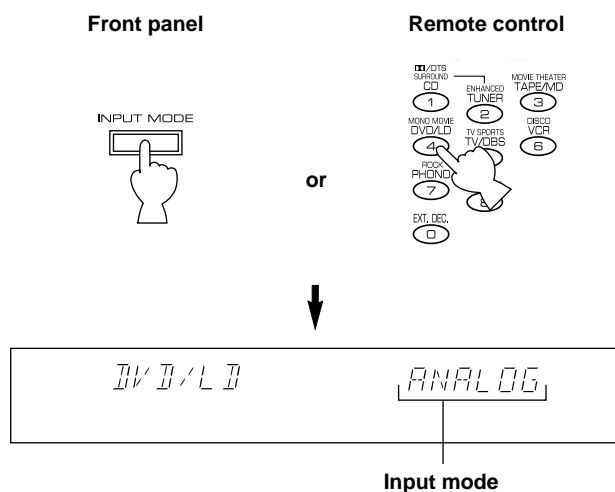

- 5** Select the main speakers to be used.

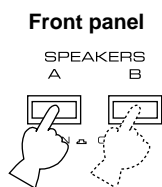

* If you use two main speaker systems, press both **A** and **B**.

- 6** Play the source. (See page 30 for detailed information on tuning.)

- 7** Adjust the volume to the desired output level.

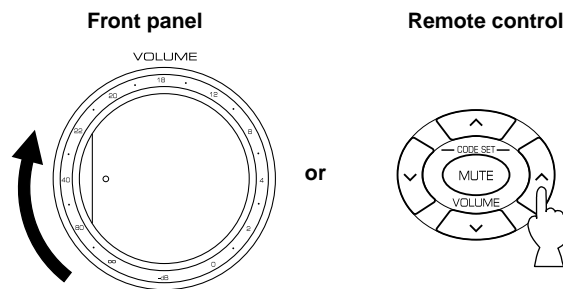

- 8** If desired, adjust **BASS**, **TREBLE**, **BALANCE**, etc. and use the digital sound field processor (see pages 36 to 37).

BASS: Turn this control clockwise to increase (or counterclockwise to decrease) the low-frequency response.

TREBLE: Turn this control clockwise to increase (or counterclockwise to decrease) the high-frequency response.

BALANCE: Adjust the balance of the output volume from the left and right speakers to compensate for any sound imbalance caused by the speaker location or listening room conditions.

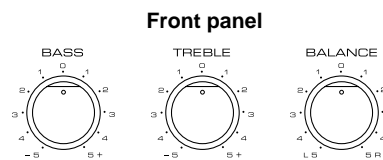

* These controls are only effective for the sound from the main speakers.

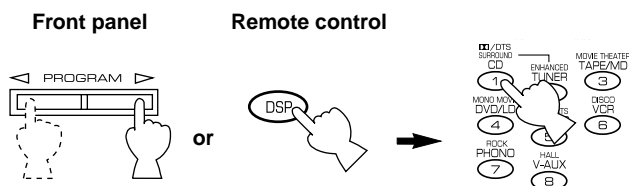

When you have finished using this unit

Press **STANDBY/ON** on the front panel again or **STANDBY** on the remote control to set this unit in the standby mode.

Notes on using INPUT

- The audio source selected by **INPUT** will not be played if the "TAPE/MD MON" indicator lights up or if "EXT. DECDR" is displayed.
- If you select a video source by **INPUT** without canceling the selection of **TAPE/MD MON / EXT. DECODER** on the front panel (or **TAPE/MD** or **EXT. DEC.** on the remote control), the play back result will be a video image from the video source and the sound from the audio source selected by **TAPE/MD MON / EXT. DECODER** on the front panel (or **TAPE/MD** or **EXT. DEC.** on the remote control).
- If an audio source is selected by **INPUT** while watching a video source, the selected audio source will be played, but the video image will not be interrupted.
- When you select an input source by **INPUT**, the DSP program (or no DSP program) that was being used when the same input source was selected the last time will be automatically recalled.
- If "DATA ERR" appears on the display while playing a CD or LD encoded with DTS, stop playback and turn the player off and then on again.

Switching the input mode (for DVD/LD and TV/DBS)

This unit allows you to switch the input mode for sources that send two or more types of signal to this unit. The following three input modes are provided.

AUTO

This mode is automatically selected when you turn on the power of this unit.

In this mode, the input signal is automatically selected in the following order of priority:

1. Digital signal encoded with Dolby Digital or DTS, or normal digital input signal (PCM)
2. Analog input signal (ANALOG)

* For a DVD/LD source, if digital signals are input from both the **OPTICAL** and **COAXIAL** terminals, the digital signal from the **COAXIAL** terminal is selected.

DTS

In this mode, only a digital input signal encoded with DTS is selected, even though other signals are input at the same time.

ANALOG

In this mode, only an analog input signal is selected, even though digital signals are input at the same time.

Select this mode when you want to use an analog input signal instead of digital input signals.

Notes on input mode selection

- The input mode for a TV/DBS source is selected with the function "INPUT" in the SET MENU mode. (See page 42 for details.)
- Set the input mode to AUTO to play a DVD/LD source encoded with Dolby Digital.
- Set the input mode to ANALOG to play a normal 2-channel source with a Dolby Surround program.
- The sound output may be interrupted in some LD and DVD players in the following situation:
The input mode is set to AUTO. A search is made while playing the disc encoded with Dolby Digital or DTS, and then disc playing is restored. The sound output is interrupted for a moment because the digital input signal was selected again.
- The input mode cannot be changed for the PHONO, TUNER, TAPE/MD, CD, VCR and VIDEO AUX sources because only analog signals are used.
- The present input mode appears on the display when the input source is changed to DVD/LD or TV/DBS, or the input mode is changed.

Notes on playing a source encoded with DTS

If you play a CD or LD encoded with DTS while the AUTO mode is selected, there will be a short noise at first while the unit identifies the DTS signal and activates the DTS decoder. This is not a malfunction, and can be avoided by setting the input mode to DTS beforehand. In addition, if you continue to play a CD or LD encoded with DTS with the input mode setting left at AUTO, this unit automatically switches to the "DTS-decoding" mode to prevent noise from being generated during future operation. (The red "dts" indicator lights up on the display.)

No sound will be heard if a normal PCM CD or LD is played in this mode. (The red "dts" indicator will flash.) To play a normal disk, return the input mode from DTS to AUTO.

TO RECORD A SOURCE ON TAPE, MD OR VIDEO CASSETTE

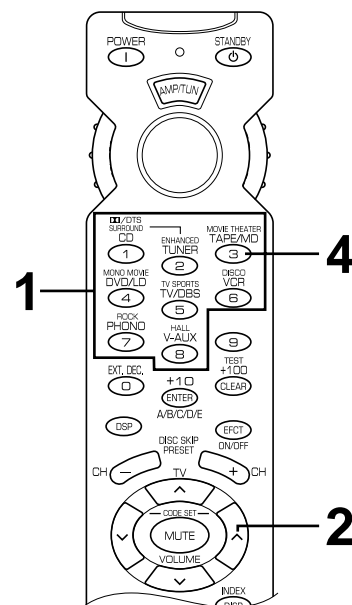
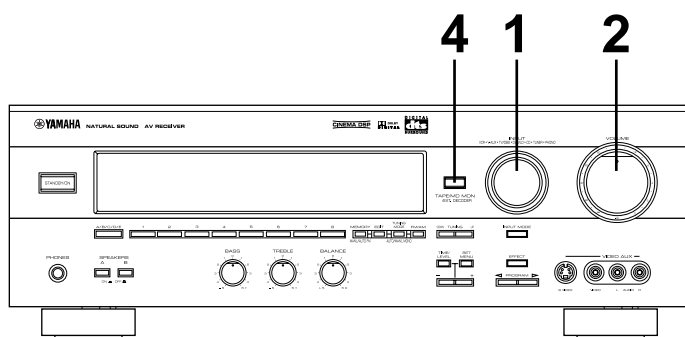

1 Select the source to be recorded.

Front panel INPUT
VCR • V-AUX • TV/OBS • DVD/LD • CD • TUNER • PHONO

Remote control

2 Play the source and then turn up the volume to confirm the input source. (See page 30 for detailed information on tuning.)

Front panel VOLUME

Remote control

3 Begin recording on the tape deck, MD recorder or VCR connected to this unit.

4 When a tape deck or MD recorder is being used for recording, you can monitor the sounds being recorded by pressing **TAPE/MD MON / EXT. DECODER** on the front panel or **TAPE/MD** on the remote control so that the "TAPE/MD MON" indicator lights up on the display.

Front panel TAPE/MD MON / EXT. DECODER

Remote control MOVIE THEATER TAPE/MD

→ TAPE/MD MON

- Notes**
- The settings of DSP and **VOLUME**, **BASS**, **TREBLE** and **BALANCE** have no effect on the material being recorded.
 - Composite video and S video signals pass independently through this unit's video circuits. Therefore, when recording or dubbing video signals, if your video source unit is connected to provide only an S video (or only a composite video) signal, you can record only an S video (or only a composite video) signal on your VCR.
 - A source that is connected to this unit only through the digital terminals cannot be recorded on a tape deck, MD recorder or VCR connected to this unit.
 - A source of signals input to the **EXTERNAL DECODER INPUT** terminals of this unit cannot be recorded.
 - Please check the copyright laws in your country to record from records, compact discs, radio, etc. Recording of copyright material may infringe copyright laws.

If you watch video software that uses scrambled or encoded signals to prevent it from being dubbed, there may be a case that the picture itself will be affected by those signals.

TUNING

Quick automatic-search tuning (AUTOMATIC TUNING) is effective when station signals are strong and there is no interference. However, if the signal from the station you want to select is weak, you must tune in to it manually (MANUAL TUNING).

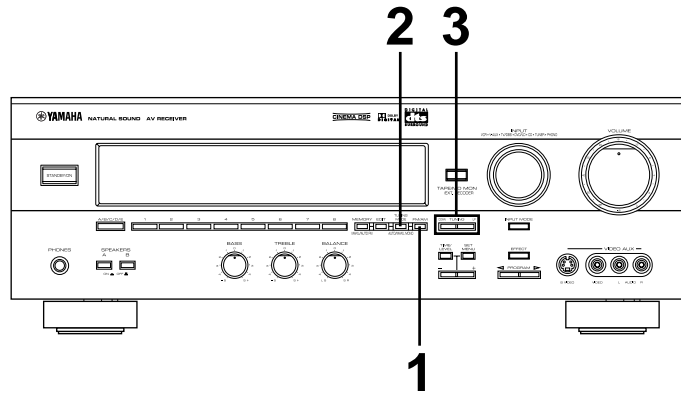

AUTOMATIC TUNING

MANUAL TUNING

Set the SELECTOR DIAL to the AMP/TUN position on the remote control and select TUNER as the input source.

- 1 Select the reception band (FM or AM) and confirm it on the display.

Front panel

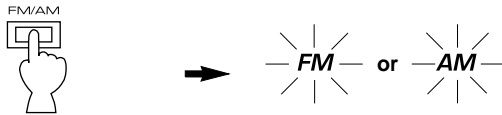

- 2 Press **TUNING MODE** so that the "AUTO TUNING" indicator lights up on the display.

Front panel

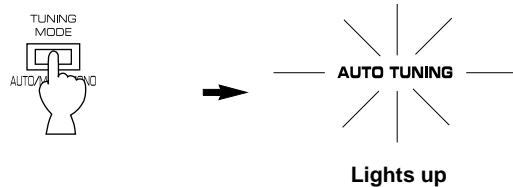

- 3 To tune in to a higher frequency, press the UP side of **TUNING** once.
To tune in to a lower frequency, press the DOWN side of **TUNING** once.

Front panel

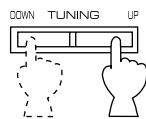

- * If the station where the tuning search stops is not the desired one, press once more.
- * If the tuning search does not stop at the desired station (because the signal from the station is weak), take the manual tuning procedure.

- 1 Select the reception band (FM or AM) and confirm it on the display.

Front panel

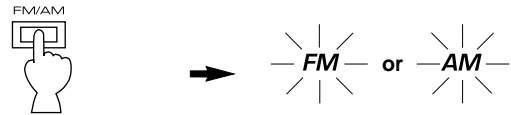

- 2 Press **TUNING MODE**.

Front panel

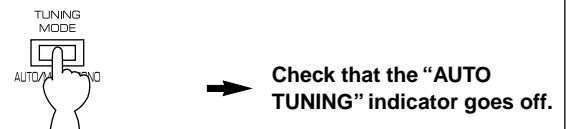

- 3 Tune in manually to the desired station.

Front panel

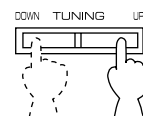

- * To continue the tuning search, press and hold the button.

Notes

- If you tune in manually to an FM station, it will be automatically received in monaural mode to increase the signal quality.
- When tuned in to a station, the frequency of the received station is shown on the display.

MANUAL PRESET TUNING

This unit can store station frequencies to be selected by tuning. With this function, you can recall any desired station simply by selecting the preset station number with which it was stored. Up to 40 stations (8 stations x 5 groups) can be stored.

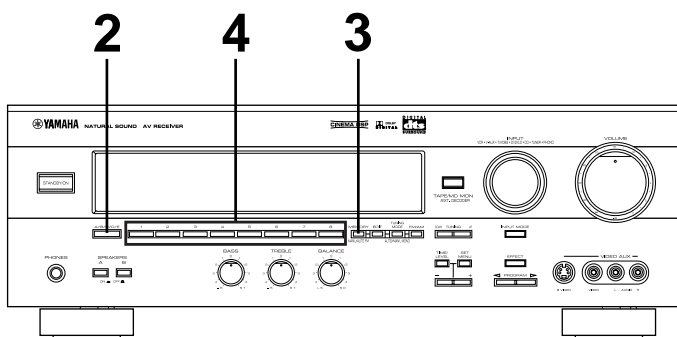

To store stations

- 1** Tune in to the desired station.
(See page 30 for the tuning procedure.)

- 2** Press **A/B/C/D/E** once or more to select the desired group (A to E) of preset stations and confirm it on the display.

Front panel



- 3** Press **MEMORY** so that the “MEMORY” indicator flashes for about five seconds.

Front panel

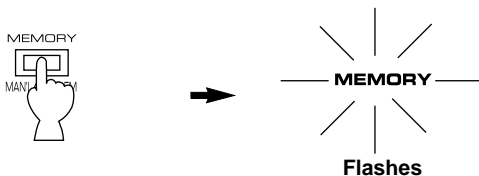

- 4** Select the preset station number with which you want to store the station before the “MEMORY” indicator goes off from the display.

Front panel

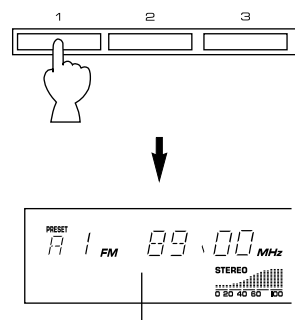

The displayed station has been stored as A1.

- * In the same way, store other stations as A2, A3 ... A8.
- * You can store more stations as preset station numbers in other groups in the same way by selecting another group in step 2.

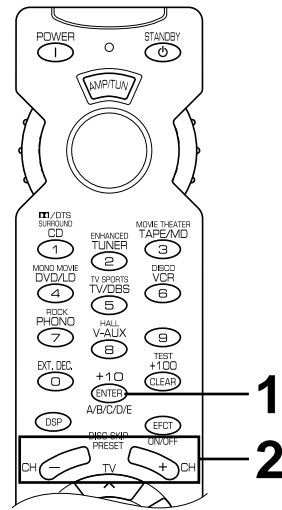
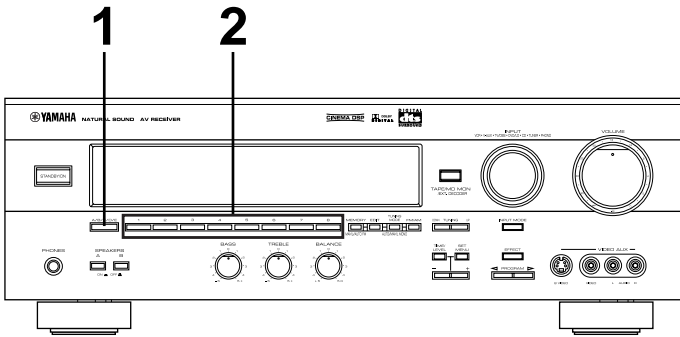

To recall a preset station

- 1 Select the group of preset stations.

Front panel

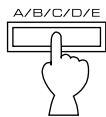

Remote control

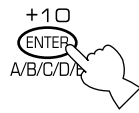

or

- 2 Select the preset station number.

Front panel

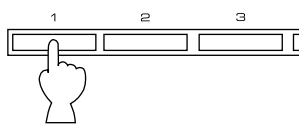

Remote control



Notes

- A new setting can be stored in place of the former one.
- For presets, the setting of the reception mode (stereo or monaural) is stored along with the station frequency.

Memory back-up

The memory back-up circuit prevents the stored data from being lost when this unit is set in the standby mode. If, however, the power plug is disconnected from the AC outlet or the power is cut due to temporary power failure for more than one week, the memory will be erased. If so, it can be re-stored by simply following the preset tuning procedure.

AUTOMATIC PRESET TUNING (for FM stations only)

You can also make use of the automatic preset tuning function for FM stations only. This function enables the unit to perform automatic tuning and to sequentially store FM stations with strong signals. Up to 40 stations can be stored automatically in the same way as that for manual preset tuning on page 31. Note that a new setting can be stored in place of the former one.

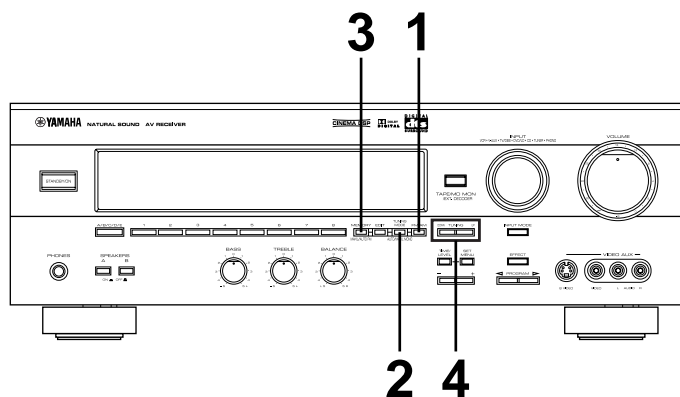

To store stations

- 1** Select the FM band.

Front panel



- 2** Press **TUNING MODE** so that the “AUTO TUNING” indicator lights up on the display.

Front panel

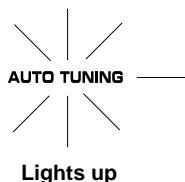
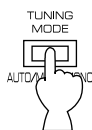

- 3** Press **MEMORY** and hold for about three seconds.

Front panel

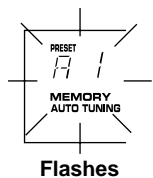
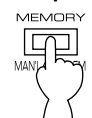

- 4** To tune in to higher frequencies, press the UP side of **TUNING** once.
To tune in to lower frequencies, press the DOWN side of **TUNING** once.

Front panel

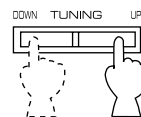

- * If **TUNING** is not pressed, automatic preset tuning soon begins automatically toward the higher frequencies.

Automatic preset tuning begins from the frequency currently displayed. Received stations are sequentially stored as A1, A2 ... A8.

- * If more than 8 stations are received, they are stored as preset station numbers in other groups (B, C, D and E) in that order.

If you want to store the first station received by automatic preset tuning as a desired preset station number

For example, if you want to store the first received station as C5, select “C5” while “A1”, the “MEMORY” indicator and the “AUTO TUNING” indicator flash after pressing **MEMORY** in step 3. Then press **TUNING**. The first received station is stored as C5, and the next stations as sequentially C6, C7 ...

If stations have all been stored up to E8, automatic preset tuning stops automatically.

When automatic preset tuning is completed

The display shows the frequency of the last preset station. Check the contents and the number of preset stations by following the procedure in the section “To recall a preset station” on page 32.

Notes

- You can manually replace a preset station with another FM or AM station by simply following the procedure in the section “To store stations” on page 31.
- Even if the number of received stations is not enough to be stored up to E8, the search is automatically ended after searching all frequencies.
- With this function, only FM stations with sufficient signal strength are automatically stored. If the station you want to store is weak in signal strength, tune in to it manually in monaural sound and store it by following the procedure in the section “To store stations” on page 31.

EXCHANGING PRESET STATIONS

You can exchange the assignment of two preset stations with each other as shown below.

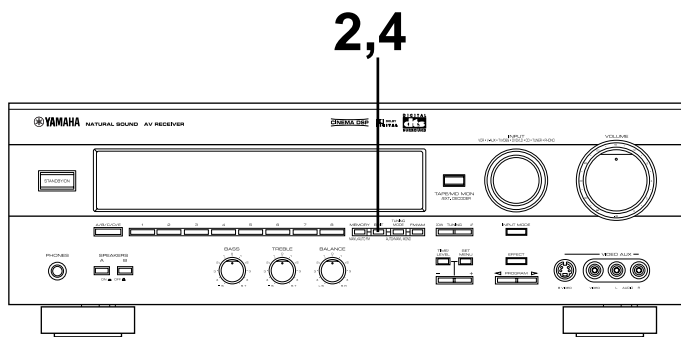

Example

If you want to change the preset station from “E1” to “A5”, or vice versa.

1 Recall preset station “E1” by following the procedure in the section “To recall a preset station” on page 32.

2 Press **EDIT**.

Front Panel

Flashes

3 Next, recall preset station “A5” by following the same procedure as that in step 1.

Flashes

4 Press **EDIT** once more.

Front Panel

Shows the exchange of stations has been completed.

SETTING THE SLEEP TIMER

The SLEEP timer can be used to make this unit automatically switch to the standby mode. When you are going to sleep while enjoying a broadcast or other desired input source, this timer function is useful. The SLEEP timer can only be controlled with the remote control.

Notes

- To set the SLEEP timer for this unit, set the SELECTOR DIAL to a position other than the TV position. To set the SLEEP timer for your TV, set the SELECTOR DIAL to the TV position.
- The components for which the SLEEP timer is effective are the sources connected to the **AC OUTLET(S)** on the rear panel of this unit.

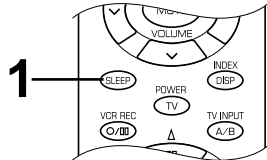

To set the SLEEP time

1 Play the source which you want to enjoy when you are going to sleep and press **SLEEP** once or more to select the desired SLEEP time.

Remote control

↓

The SLEEP time is displayed.

Flashes

Each time you press **SLEEP**, the SLEEP time will change as follows:

(Minutes)

120 → 90 → 60 → 30

The SLEEP timer is off (SLEEP OFF).
(This is the state before SLEEP is pressed.)

The "SLEEP" indicator soon lights up and the display returns to the indication before the SLEEP timer was set.

2 The unit will be switched to the standby mode automatically at the selected SLEEP time.

To cancel the selected SLEEP time

Remote control



Press **SLEEP** once or more so that "SLEEP OFF" appears on the display. (It will soon disappear and the "SLEEP" indicator will go off from the display.)

Note

The SLEEP timer setting can also be canceled by setting the unit in the standby mode with **STANDBY/ON** on the front panel (or **STANDBY** on the remote control) or by disconnecting the power plug of the unit from the AC outlet.







SOUND FIELD PROGRAM







This unit incorporates a sophisticated, multi-program digital sound field processor. This processor allows you to electronically expand and change the shape of the audio sound field from both audio and video sources, creating a theater-like experience in your listening room. You can create outstanding audio sound by selecting a suitable sound field program (this will, of course, depend on what you are listening to) and adding any desired adjustments.

The operation of built-in decoders (Dolby Pro Logic, Dolby Digital and DTS) can be controlled by selecting a corresponding DSP program incorporating the combined operation of YAMAHA DSP and Dolby Surround, Dolby Digital or DTS.

The following list gives you a brief description of the sound fields produced by each of the DSP programs. Keep in mind that most of these are precise digital re-creations of actual acoustic environments.

For movie or audio/video sources

No.	PROGRAM	FEATURES
1	<p>Normal Program</p> <p>[1] DOLBY PRO LOGIC ()</p> <ul style="list-style-type: none"> • Input source : Dolby Surround 2-ch Dolby Digital • Output channel : 4 channels • DSP : — <p>[2] DOLBY DIGITAL ()</p> <ul style="list-style-type: none"> • Input source : Dolby Digital • Output channel : 5.1 channels • DSP : — <p>[3] DTS ()</p> <ul style="list-style-type: none"> • Input source : DTS • Output channel : 5.1 channels • DSP : — 	<p>The built-in Dolby Pro Logic, Dolby Digital or DTS decoder precisely reproduces the sound and effect of the encoded source.</p> <p>The realization of a highly efficient decoding process improves cross talk and channel separation and makes sound positioning smoother and more precise.</p>
2	<p>Enhanced Program</p> <p>[1] DOLBY PRO LOGIC/Enhanced ()</p> <ul style="list-style-type: none"> • Input source : Dolby Surround 2-ch Dolby Digital • Output channel : 4 channels • DSP : 1 (surround) <p>[2] DOLBY DIGITAL/Enhanced ()</p> <ul style="list-style-type: none"> • Input source : Dolby Digital • Output channel : 5.1 channels • DSP : 2 (surround L, R) <p>[3] DTS/Enhanced ()</p> <ul style="list-style-type: none"> • Input source : DTS • Output channel : 5.1 channels • DSP : 2 (surround L, R) 	<p>This program ideally simulates the multi-surround speaker systems of the 35 mm-film movie theater. Each decoding and digital sound field processing operation is precisely performed without altering the original sound orientation.</p> <p>The surround effect produced by the sound field folds around the viewer naturally from the rear to the left and right and toward the screen.</p>

No.	PROGRAM	FEATURES
3	<p>CINEMA DSP Program</p> <p>[1] 70 mm MOVIE THEATER ( )</p> <ul style="list-style-type: none"> • Input source : Dolby Surround 2-ch Dolby Digital • Output channel : 3 channels • DSP : 2 (presence & surround) <p>[2] 70 mm MOVIE THEATER – DOLBY D. ( )</p> <ul style="list-style-type: none"> • Input source : Dolby Digital • Output channel : 5.1 channels • DSP : 3 (presence & surround L, R) <p>[3] 70 mm MOVIE THEATER – DTS ( )</p> <ul style="list-style-type: none"> • Input source : DTS • Output channel : 5.1 channels • DSP : 3 (presence & surround L, R) 	<p>Creates the extremely wide sound field of a movie theater. It precisely reproduces the source sound in detail, giving both the video and the sound field incredible reality. Any kind of video source encoded with Dolby Digital or DTS (especially large-scale movie productions) is ideal for use with this program.</p>
4	<p>MONO MOVIE</p> <ul style="list-style-type: none"> • Input source : Monaural • Output channel : 1 • DSP : 1 	<p>This program is designed specifically to enhance monaural sources. Compared to a strictly mono setting, the sound image is wider and slightly forward of the speaker pair, lending an immediacy to the overall sound.</p>
5	<p>TV SPORTS</p> <ul style="list-style-type: none"> • Input source : Audio/Video • Output channel : 2 to 5.1 channels • DSP : 2 to 3 (presence & surround) 	<p>This program is furnished with a tight sound field in which the sound will not spread excessively at the front, but the rear surround produces dynamic sound expansion.</p>

For Hi-Fi Audio sources

No.	PROGRAM	FEATURES
6	<p>Hi-Fi DSP Program</p> <ul style="list-style-type: none"> • Input source : 2-ch PCM/Analog audio • Output channel : 2 channels • DSP : 1 <p>[1] DISCO</p> <p>[2] ROCK CONCERT</p> <p>[3] CONCERT HALL</p>	<p>Simulates the acoustics of disco in the heart of a lively city. The sound is dense and highly concentrated.</p> <p>Ideally suited for rock music. You will experience a dynamic and lively sound field.</p> <p>Creates the expansive ambience of a large concert hall. Orchestra and opera music are suited to this program.</p>

PLAYING A SOURCE WITH THE DIGITAL SOUND FIELD PROCESSOR (DSP) EFFECT

Follow steps 1 to 7 shown in "TO PLAY A SOURCE" on pages 26 to 27.

Select the desired DSP program that is suitable for the source.

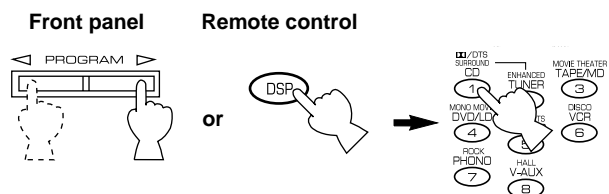

Press DSP. While the indicator is lit up for about three seconds, select a DSP program with the numeric buttons (1 to 8).

* If the SELECTOR DIAL is set to the DSP position, you can also select a DSP program directly with the numeric buttons (1 to 8).



The name of the selected program appears on the display.

If desired, adjust the delay time and the output level of each speaker. (See pages 39 and 40 for details.)

The following indicators on the display show you what sound processing is being undertaken.

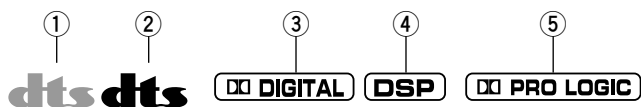

- ① This lights up in orange when a DVD source encoded with DTS is played back and DTS is decoded.
- ② This lights up in red when an LD source or a CD source encoded with DTS is played back and DTS is decoded.
- ③ This lights up when Dolby Digital is being decoded and the signals of the selected source encoded with Dolby Digital is not in 2-channel.
- ④ This lights up when the digital sound field processor is turned on.
- ⑤ This lights up when Dolby Surround is being decoded by Dolby Pro Logic.

TO CANCEL THE SOUND EFFECT

To cancel the sound effect and monitor only the main sound, press **EFFECT** or **EFCT ON/OFF**. Press **EFFECT** or **EFCT ON/OFF** once more to turn sound effect back on.

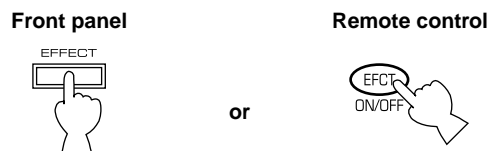

Notes

- You can select a program for each of the input sources. Once you select a program, it is linked with the input source selected at that time. So, when you select the input source next time, the same program is automatically called up.
- When a monaural sound source is being played with **DOLBY PRO LOGIC** or **DOLBY PRO LOGIC ENHANCED**, no sound will be heard from the main speakers and the rear speakers. Sound can only be heard from the center speaker. However, if the NONE position is selected for "CNTR" in the SET MENU mode, the main speakers will output the sound of the center channel.
- When the source of signals input to the **EXTERNAL DECODER INPUT** terminals of this unit is selected, DSP cannot be used.
- If the sound effect is canceled when signals encoded with Dolby Digital or DTS are input to this unit, the signals of all channels are mixed and are output from the main speakers.
- If **EFFECT** or **EFCT ON/OFF** is pressed to turn the sound effects off when Dolby Digital or DTS is decoded, it may happen that the sound is output faintly or not output normally, depending on the source. In that case, press **EFFECT** or **EFCT ON/OFF** to turn on the sound effects.

If you change the LD (or CD) being played back with DTS being decoded to another disc that is not encoded with DTS when the red "dts" indicator lights up, playing back the newly selected disc will result in no sound output. In this state, the red "dts" indicator flashes to show that this unit is locked in the DTS-decoding mode. To play back the disc normally, change the current DTS-decoding mode to another mode by **INPUT MODE** on the front panel or by **INPUT** on the remote control so that the red "dts" indicator goes off.

ADJUSTING THE DELAY TIME AND SPEAKER OUTPUT LEVELS

When using the digital sound field processor with the Dolby Pro Logic decoder, the Dolby Digital decoder or the DTS decoder, you can adjust the delay time between the main sound and sound effect, and each speaker's output level as you prefer.

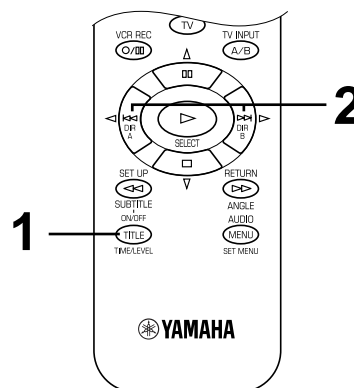
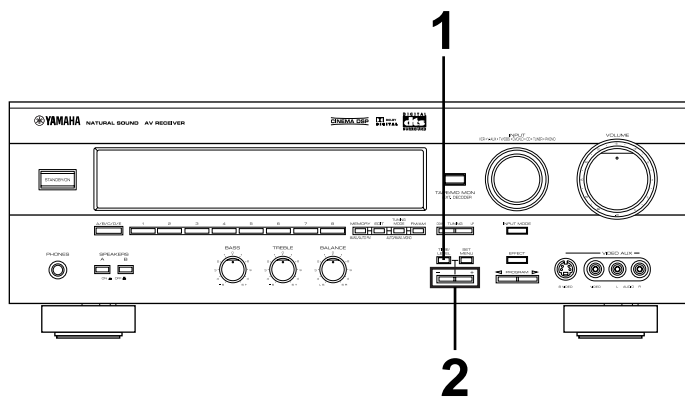

Adjustment method

When adjusting with the remote control, set the SELECTOR DIAL to the AMP/TUN or DSP position on the remote control.



or



- 1 Press **TIME/LEVEL** once or more until the name of the item which you want to adjust appears on the display.

Front panel

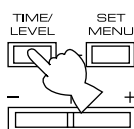

Remote control



or

- * After pressing **TIME/LEVEL** once on the remote control, you can also select the name of item by pressing ∇ .

When pressed, the selection changes as follows:

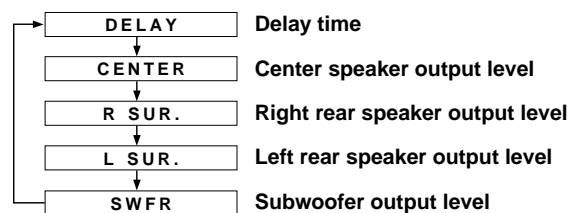

- * Pressing Δ on the remote control changes the selection in the reverse order.

- * Depending on the setting in the SET MENU mode, you may not be able to select all these items.

- 2 Press **+** or **-** to adjust the settings for the delay time or speaker output levels.

Front panel

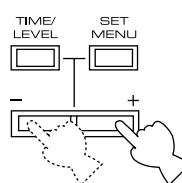

or

Remote control

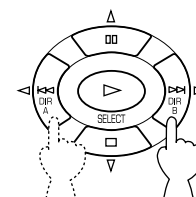

- 3 Repeat steps 1 and 2 to adjust the settings of any other item.

Adjusting the delay time

You can adjust the time difference between the beginning of the sound from the main speakers and the beginning of the sound effect from the rear speakers.

The larger the value, the later the sound effect is generated. This adjustment can be individually made to all programs.

Notes

- Adding too much delay will cause an unnatural effect with some sources.
- When + or – is pressed, the sound is momentarily interrupted.

Program	Control range (ms)	Preset value
1. DOLBY PRO LOGIC	15 to 30	20
DOLBY DIGITAL	0 to 15	5
DTS	0 to 15	5
2. DOLBY PRO LOGIC/Enhanced	15 to 30	20
DOLBY DIGITAL/Enhanced	0 to 15	5
DTS/Enhanced	0 to 15	5
3. 70 mm MOVIE THEATER	15 to 30	20
70 mm MOVIE THEATER – DOLBY D.	1 to 99	16
70 mm MOVIE THEATER – DTS	1 to 99	16
4. MONO MOVIE	1 to 99	49
5. TV SPORTS	1 to 99	9
6. DISCO	1 to 99	40
7. ROCK CONCERT	1 to 99	16
8. CONCERT HALL	1 to 99	44

Adjusting the output level of the center, right rear and left rear speakers, and subwoofer

If desired, you can adjust the sound output level of each speaker even if the output level has already been set in "SPEAKER BALANCE ADJUSTMENT" on pages 23 to 25.

Notes

- The output level of the center speaker cannot be adjusted when the **DISCO**, **ROCK CONCERT** or **CONCERT HALL** program is selected, and the input signal is analog, PCM audio, or encoded with Dolby Digital in 2-channel.

- If the function "CNTR" in the SET MENU mode is set to the NONE position, the sound output level of the center speaker cannot be adjusted. This is because, in this mode, the center speaker sound is automatically output from the left and right main speakers.
- Once the output level has been adjusted, the level will be the same for all digital sound field programs.

Speaker	Control range (dB)	Preset value
CENTER	MIN, –20 to +10	0
RIGHT REAR	MIN, –20 to +10	0
LEFT REAR	MIN, –20 to +10	0
SUBWOOFER	MIN, –20 to 0	0

Memory back-up

The memory back-up circuit prevents the stored data from being lost when this unit is set in the standby mode. If, however, the power plug is disconnected from the AC outlet or the power is cut due to temporary power failure for more than one week, the latest values for the delay time and the center/rear/subwoofer output levels that were set will automatically return to the preset values. If so, they can be re-set by simply following the adjustment method on page 39.

ADJUSTMENTS IN THE “SET MENU” MODE

The following ten types of functions will maximize the performance of your system and expand your enjoyment for audio listening and video watching.

1. **CNTR (CENTER SPEAKER)**
2. **REAR (REAR SPEAKERS)**
3. **MAIN (MAIN SPEAKERS)**
4. **BASS (LFE/BASS OUT)**
5. **M.LVL (MAIN LEVEL)**
6. **D.D.LFE
(DOLBY DIGITAL LFE LEVEL)**
7. **D.RNG (DYNAMIC RANGE)**
8. **DTS LFE (DTS LFE LEVEL)**
9. **C.DELAY (CENTER DELAY)**
10. **GUARD (MEMORY GUARD)**
11. **INPUT (INPUT MODE)**

For details on “CNTR”, “REAR”, “MAIN”, “BASS” and “M.LVL”, see page 21. (Once you have selected the appropriate settings, you do not have to change any settings unless an alteration is made in your speaker system.)

D.D.LFE (Adjusting the level of the LFE channel for Dolby Digital)

Control range: –20 dB to 0 dB (in 1 dB steps)

Preset value: 0 dB

* This adjustment is effective only when Dolby Digital is being decoded and the signals of the selected source encoded with Dolby Digital contain LFE signals.

This adjusts the output level of the LFE channel. If the LFE signals are mixed with signals of other channels and they are output from the same speakers, the ratio of the LFE signal level to the level of the other signals can be adjusted. (See page 8 for details about the LFE channel.)

D.RNG (Adjusting the dynamic range)

Choices: MAX/STD/MIN

Preset position: MAX

* This adjustment is effective only when Dolby Digital is being decoded.

“Dynamic range” is the difference between the maximum level and the minimum level of sounds.

Sounds on a movie originally designed for movie theaters feature a very wide dynamic range.

Dolby Digital technology can modify the original sound track into a home audio format with this wide dynamic range unchanged.

Powerful sounds of extremely wide dynamic range are not always suitable for home use. Depending upon the condition of your listening environment, it may not be possible to increase the sound output to a level as high as that in a movie theater.

However, at the normal level suitable for listening in your room, the low-level parts of source sound often cannot be heard well because they will be lost among noise in your environment. Dolby Digital technology has also made it possible to reduce an original sound track’s dynamic range for a home audio format by “compressing” the sound data.

MAX: In this position, a source encoded with Dolby Digital is reproduced in the original sound track’s wide dynamic range to provide you with powerful sounds just like those in a movie theater.

Selecting this position will be even better if you can listen to a source at a high output level in a room specially soundproofed for audio/video enjoyment.

STD (Standard):

In this position, a source encoded with Dolby Digital is reproduced in the “compressed” dynamic range of the source that is suitable for low-level listening.

MIN: In this position, the dynamic range is more reduced than in the STD position.

Selecting this position will be effective when you must listen to a sound source at a low level.

* In this position, it may happen that sound is output faintly or not output normally depending on the source. In that case, select the MAX or STD position.

DTS LFE (Adjusting the level of the LFE channel for DTS)

Control range: –10 dB to +10 dB (in 1 dB steps)

Preset value: 0 dB

* This adjustment is effective only when DTS is being decoded and the signals of the selected source encoded with DTS contain LFE signals.

This adjusts the output level of the LFE channel. If the LFE signals are mixed with signals of other channels and they are output from the same speakers, the ratio of the LFE signal level to the level of the other signals can be adjusted. (See page 8 for details about the LFE channel.)

C.DELAY [Adjusting the delay of center sounds (dialog, etc.)]

Control range: 0 ms to 5 ms (in 1 ms steps)
Preset value: 0 ms

- * This adjustment is effective only when Dolby Digital or DTS is being decoded and the signals of the selected source encoded with Dolby Digital or DTS contain center-channel signals.

This adjusts the delay between the main sound (on the main channels) and dialog, etc. (on the center channel). The larger the value, the later the dialog, etc. is generated.

This is for making sounds from the left main, center and right main speakers reach your listening position at the same time. This is achieved by delaying the sound from the center speaker if the distance from the center speaker to your listening position is shorter than the distance from the left or right main speaker to your listening position.

GUARD (Memory guard)

Choices: ON/OFF
Preset position: OFF

If you wish to prevent accidental alterations to SET MENU and other adjustments on this unit, select ON. The following functions on this unit can be locked by this operation:

- Other functions in the SET MENU mode
- Functions in the TIME/LEVEL mode
- Functions when using **TEST**

INPUT (Selecting the mode of the TV/DBS input)

Choices: AUTO/LAST
Preset position: AUTO

You can designate the input mode that is automatically selected when the power of this unit is switched on for only the sources connected to the TV/DBS input terminals of this unit.

- AUTO:** In this position, the AUTO input mode is always selected when the power for this unit is switched on.
- LAST:** In this position, the input mode you selected last time is memorized and will not be changed when the power is switched on again.

- * See page 28 for details on switching the input mode.

Adjustment method

Adjustments should be made while watching the information on this unit's display.

When adjusting with the remote control, set the SELECTOR DIAL to the AMP/TUN or DSP position on the remote control.

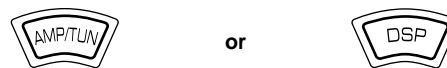

Press **SET MENU** once or more so that the function which you want to change appears on the display.

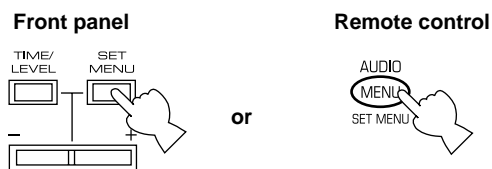

- * After pressing **SET MENU** once on the remote control, you can also select the title by pressing ∇ . (Pressing Δ goes back one selection.)

Press **+** or **-** to select any desired position or to edit parameters of the chosen function.

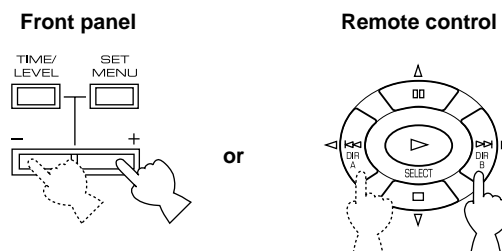

Repeat these steps to change or adjust the settings of any other function.

Memory back-up

The memory back-up circuit prevents the stored data from being lost when this unit is set in the standby mode. If, however, the power plug is disconnected from the AC outlet or the power is cut due to temporary power failure for more than one week, the settings of the SET MENU mode will automatically return to the factory settings. If so, they can be re-set by simply following the procedure above.

REMOTE CONTROL

You can use the remote control to control not only this unit but also other components connected to it. The remote control is factory set to control this unit and most YAMAHA audio components.

To control other brands of components, you must preset the remote control with the manufacturers' codes listed from page 105.

Components which can be controlled

There are nine positions that you can select to control connected components with this remote control. When turning the SELECTOR DIAL, the position changes as follows:

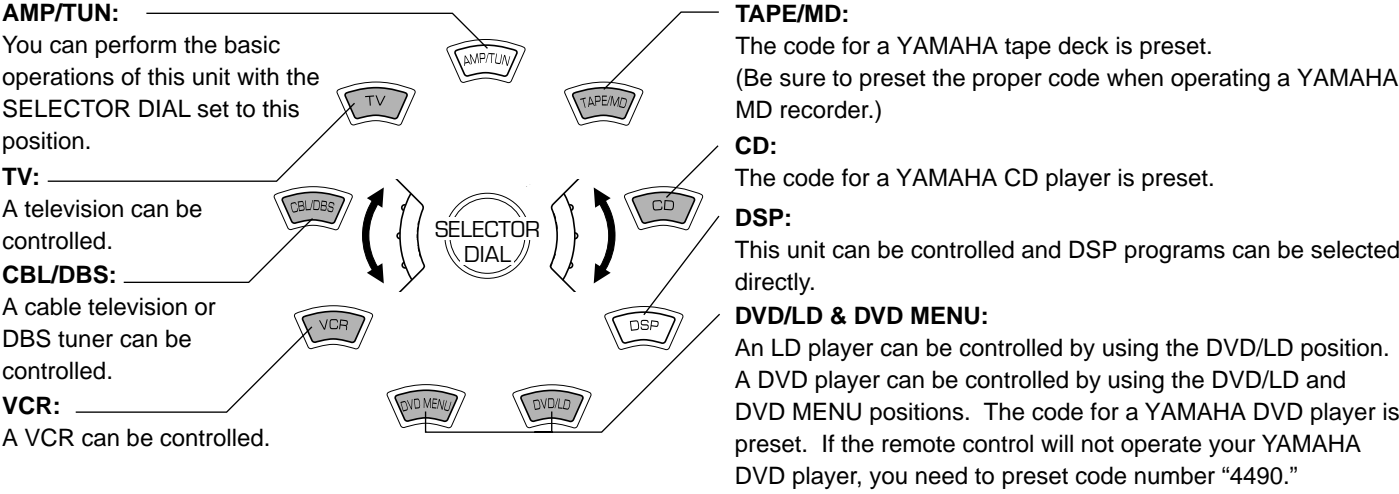

Notes

- The shaded positions in the diagram above indicate that you can preset the code for the manufacturer of your component. Note that you can preset only one code for one position. (See "SETUP CODES" on page 49 for details).
- DVD/LD and DVD MENU positions:
 - Be sure that the SELECTOR DIAL is set to the DVD/LD position before presetting the code for a DVD or an LD player. The code that you preset to the DVD/LD position is also simultaneously preset to the DVD MENU position. You cannot preset the code for a DVD player when the SELECTOR DIAL is set to the DVD MENU position.
 - DVD MENU operations cannot be performed for some DVD players.
- When using a second (and third) VCR (See "To use a second (and third) VCR" on page 49 for details.):
 - If you are not using a CBL/DBS (cable TV or DBS tuner), the second (or third) VCR can be preset by using the CBL/DBS position.
 - If you are not using a DVD player, the second (or third) VCR can be preset by using the DVD MENU position. Note that in this case you must preset the code for an LD player to the DVD/LD position even if an LD player is not being used.
- The button functions on the remote control differ depending on the position selected by the SELECTOR DIAL. Refer to the following pages for details.

Basic operation

<p>1 Select the position for the component that you want to control by turning the SELECTOR DIAL. Note: Turn the SELECTOR DIAL until it stops with a click.</p> <p>The position name is displayed in this window.</p>	<p>2 Press the desired operation button. Note: Press the button with the remote control aimed at the front panel.</p> <p>Indicator The indicator will flash when the button is pressed.</p>
--	--

The lightly marked buttons do not function.

AMP/TUN

Note: TV POWER and TV VOLUME function if you have preset the code for your TV.

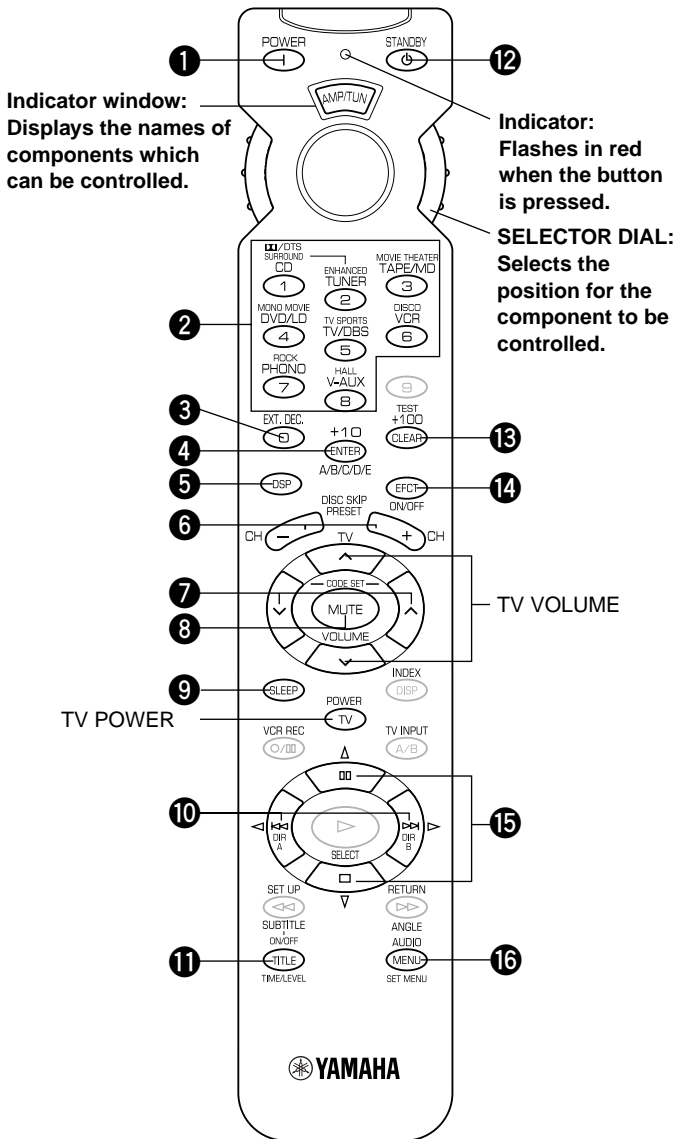

Indicator window:
Displays the names of components which can be controlled.

Indicator:
Flashes in red when the button is pressed.

SELECTOR DIAL:
Selects the position for the component to be controlled.

1 POWER

This button turns the unit on.

2 INPUT

Press one of these buttons to select the required input source.

3 EXT. DEC.

Press this button when using an external decoder.

4 A/B/C/D/E

Press this button to select a group of preset stations.

5 DSP

Press this button. While the indicator is lit up for about three seconds, select a DSP program by using the number buttons (1 to 8). No DSP program can be selected after the indicator goes off.

6 PRESET (+/-)

Press these buttons to select the preset station number.

7 VOLUME (^ v)

Press these buttons to adjust the volume level.

8 MUTE

Press this button to mute the sound. To cancel mute, press this button once more, or press the operation buttons of this unit.

9 SLEEP

Press this button to set the SLEEP timer.

10 < (LEFT), > (RIGHT)

These buttons are used to adjust the settings of the SET MENU mode and the TIME/LEVEL mode.

11 TIME/LEVEL

Press this button to set the unit in the TIME/LEVEL mode and to select the item.

12 STANDBY

Press this button to set this unit in the standby mode.

13 TEST

Press this button to output a test tone for adjusting the output level of the speakers.

14 EFCT (EFFECT) ON/OFF

Press this button to turn on or off the DSP program which includes the Dolby Pro Logic decoder, the Dolby Digital decoder and the DTS decoder.

15 ∇ (NEXT), ∆ (BACK)

These buttons are used to advance or go back one selection in the SET MENU mode and TIME/LEVEL mode.

16 SET MENU

Press this button to set the unit in the SET MENU mode and to select functions.

DSP

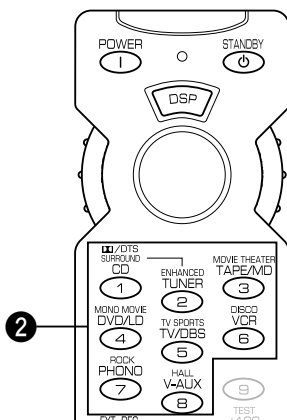

2 DSP program

Press one of these buttons to select the required DSP program (1 to 8). When you select the input source, set the SELECTOR DIAL to the AMP/TUN position.

Note: The function of all buttons other than DSP program is the same as that with the AMP/TUN position.

The lightly marked buttons do not function. See "AMP/TUN" on page 44 for those buttons which are not described here. Please refer to the owner's manual for details of each component.

■ TAPE/MD

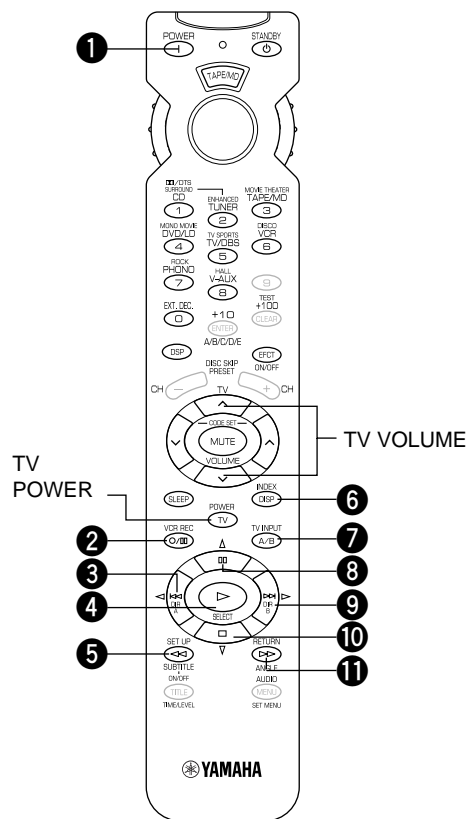

Notes:

- **TV POWER** and **TV VOLUME** function if you have preset the code for your TV.
- Be sure to preset the proper code for your MD recorder.

TAPE

1 POWER

This button turns the unit on under factory settings. If another code for your tape deck whose remote control has a power button is preset, the button will turn on the tape deck.

2 ○/⏸ (REC/PAUSE)

Press this button to give a pause in recording on the tape deck.

3 ◀ DIR A

Press this button to select the playing direction of deck A.

4 ▶ (PLAY)

Press this button to play a tape.

5 ◀◀ (REWIND)

Press this button to rewind a tape.

7 DECK A/B

Press this button to select deck A or B on the double cassette tape deck.

9 ▶ DIR B

Press this button to select the playing direction of deck B.

10 ◻ (STOP)

Press this button to stop the operation of a tape.

11 ▶▶ (FAST FORWARD)

Press this button to fast forward a tape.

MD

1 POWER

This button turns the unit on if you have preset the code for the YAMAHA MD recorder. If another code for your MD recorder whose remote control has a power button is preset, the button will turn on the MD recorder.

2 ○/⏸ (REC/PAUSE)

3 ⏮ (SKIP)

4 ▶ (PLAY)

5 ◀◀ (SEARCH)

6 DISP (DISPLAY)

8 ⏸ (PAUSE)

9 ▶▶ (SKIP)

10 ◻ (STOP)

11 ▶▶ (SEARCH)

■ CD

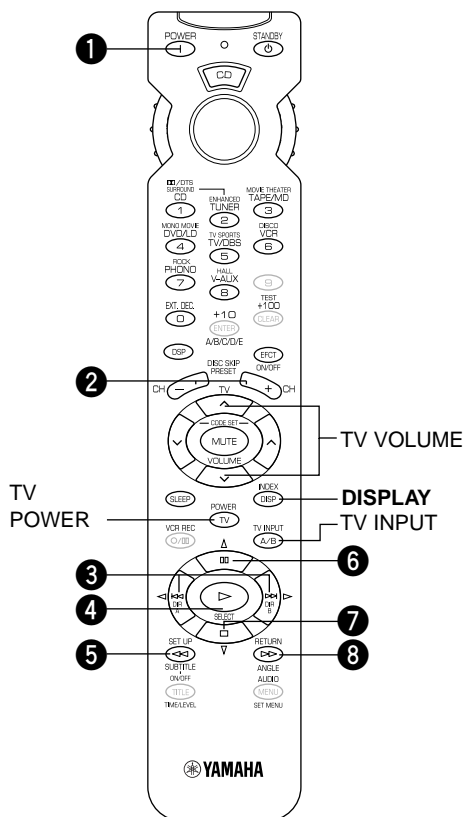

Note: **TV POWER**, **TV VOLUME** and **TV INPUT** function if you have preset the code for your TV.

1 POWER

This button turns the unit on under factory settings. If another code for your CD player whose remote control has a power button is preset, the button will turn on the CD player.

2 DISC SKIP (+/-) (for a CD player with a CD changer)

Press these buttons to skip to the next or previous CD.

3 ⏮, ⏭ (SKIP)

Press ⏮ to skip to the beginning of the next track. Press ⏭ to skip to the beginning of the previous track.

4 ▶ (PLAY)

Press this button to play a CD.

5 ◀◀ (SEARCH)

This button initiates a backward search on the track that is playing to find the point from which you want to listen.

6 ⏸ (PAUSE)

Press this button to give a pause in operation. This button functions as **PAUSE/STOP*** for operating YAMAHA CD players under factory settings.

7 ◻ (STOP)

Press this button to stop operation. This button functions as **PAUSE/STOP*** for operating YAMAHA CD players under factory settings.

8 ▶▶ (SEARCH)

This button initiates a fast-forward search on the track that is playing to find the point from which you want to listen.

* **PAUSE/STOP** function ... Press the button once to give a pause in operation and once more to stop operation.

The lightly marked buttons do not function. See "AMP/TUN" on page 44 for those buttons which are not described here. Please refer to the owner's manual for details of each component.

■ DVD/LD

POWER

(DVD) This button turns the unit on under factory settings. If another code for your DVD player whose remote control has a power button is preset, the button will turn on the DVD player.

(LD) This button turns the unit on if you have preset the code for the YAMAHA LD player. If another code for your LD player whose remote control has a power button is preset, the button will turn on the LD player.

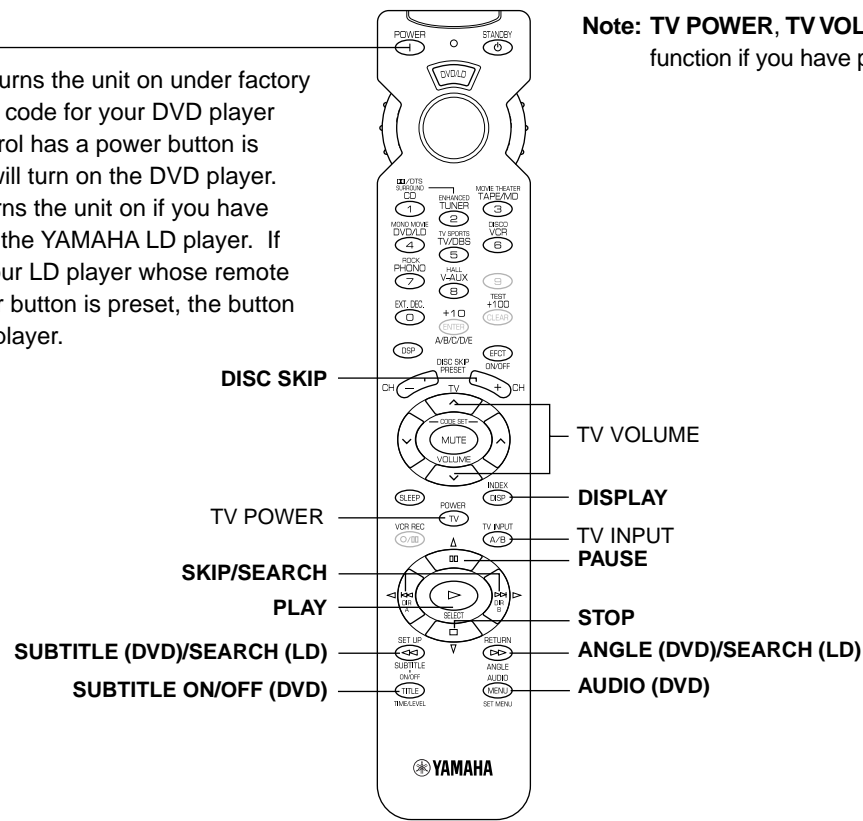

■ DVD MENU

POWER

This button turns the unit on under factory settings. If another code for your DVD player whose remote control has a power button is preset, the button will turn on the DVD player.

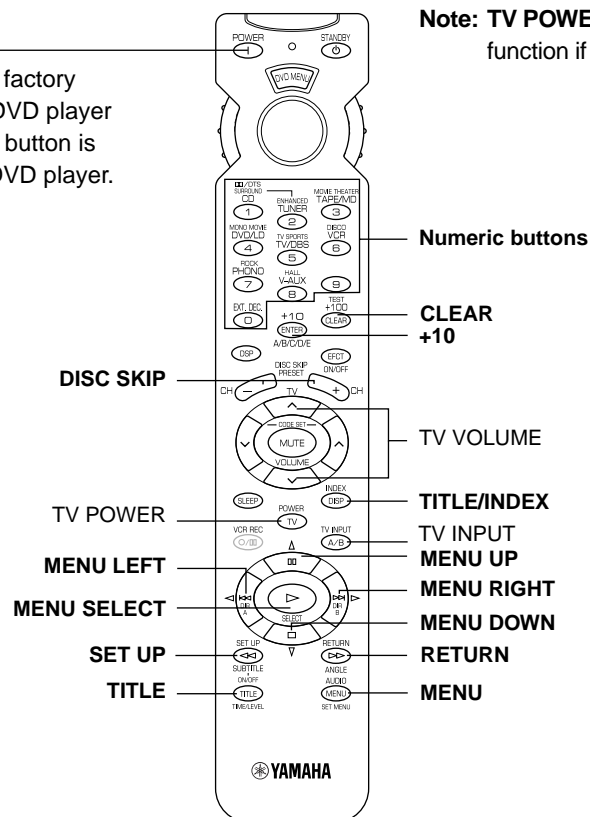

The lightly marked buttons do not function. See "AMP/TUN" on page 44 for those buttons which are not described here. Please refer to the owner's manual for details of each component.

VCR

Note: TV POWER, TV VOLUME and TV INPUT function if you have preset the code for your TV.

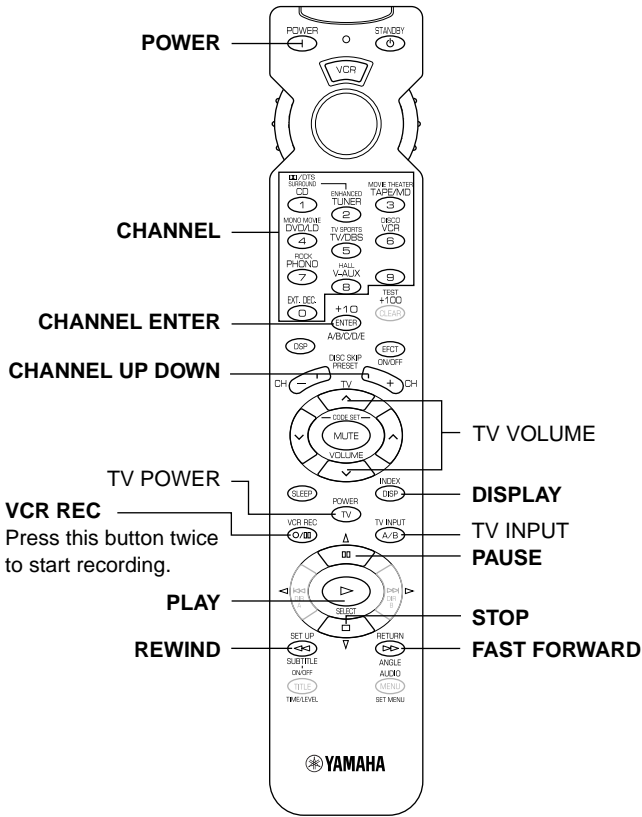

TV

Note: You can only control your VCR if you have preset the code for it.

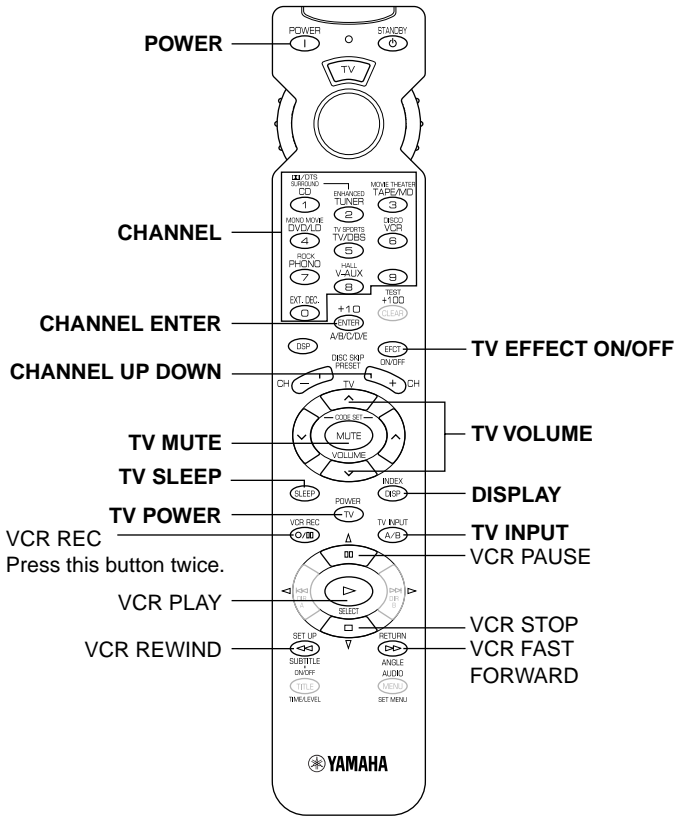

CBL/DBS

Note: TV POWER, TV VOLUME and TV INPUT function if you have preset the code for your TV.

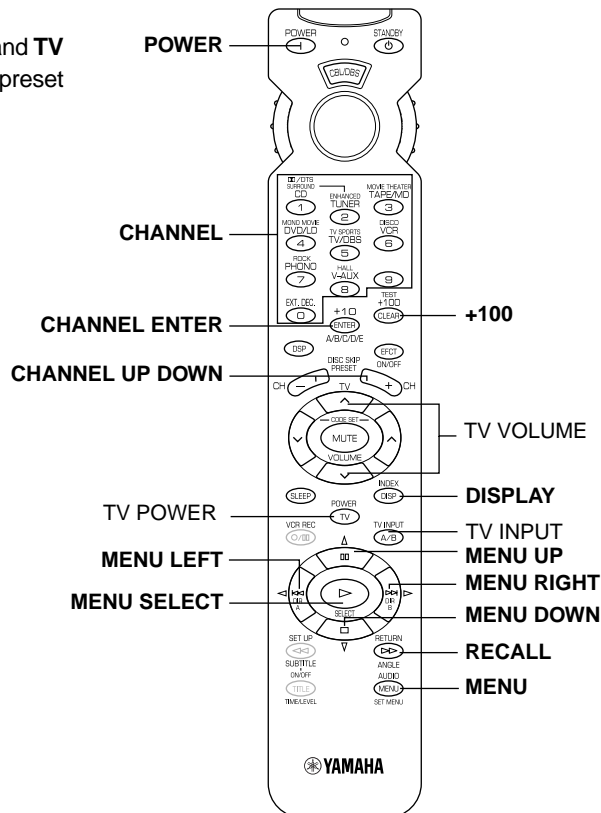

NOTES ABOUT THE REMOTE CONTROL

Battery installation

1. Turn the remote control over and slide the battery compartment cover in the direction of the arrow.
2. Insert the batteries (AA, R6 or UM-3 type) according to the polarity markings on the inside of the battery compartment.
3. Close the battery compartment cover.

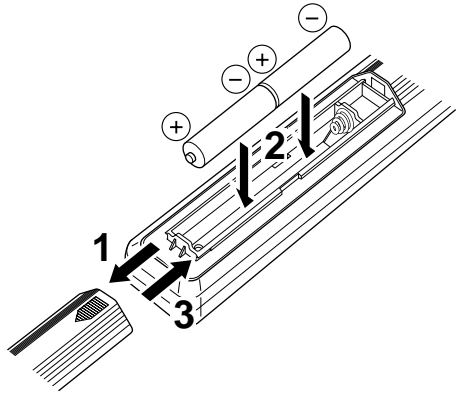

Battery replacement

If the remote control operates only when it is close to the unit, the batteries are weak. Replace all the batteries with new ones.

Be sure to replace the batteries within about two minutes. If it takes longer than two minutes, the codes preset for the remote control will return to the factory settings.

Notes

- Use only AA, R6 or UM-3 batteries for replacement.
- Be sure the battery polarity is correct. (See the illustration inside the battery compartment.)
- Remove the batteries if the remote control will not be used for an extended period of time.
- If the batteries have leaked, dispose of them immediately. Avoid touching the leaked material or letting it come into contact with clothing, etc. Clean the battery compartment thoroughly before installing new batteries.

Remote control operation range

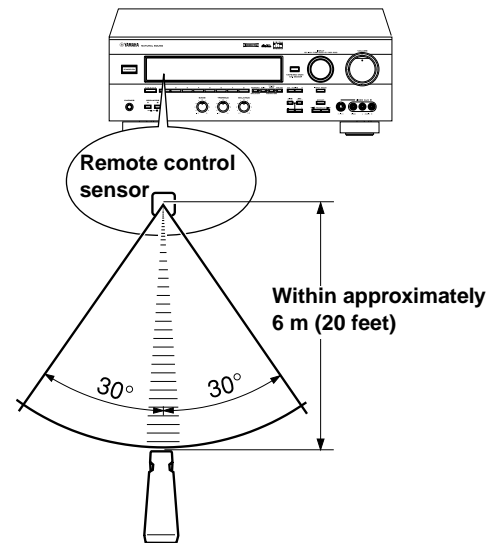

Notes

- There should be no large obstacles between the remote control and the unit.
- If the remote control sensor is directly illuminated by strong lighting (especially from an inverter type of fluorescent lamp), it might cause the remote control not to work correctly. In this case, reposition the unit to avoid direct lighting.

SETUP CODES

Presetting the remote control

Perform the presetting procedure for each component you want to control with the remote control.

Note: If your component does not respond to any of the codes listed for the manufacturer, use the original remote control that was supplied with the component.

To control your components (MD recorder, DVD player, TV, etc.)

1. Turn on the component to be used.
2. Set the SELECTOR DIAL to the desired position for the component (TAPE/MD, DVD/LD, TV, etc.).

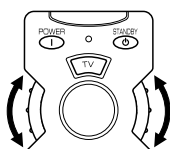

3. Press both **VOLUME** buttons (^ v) for about four seconds at the same time so that the indicator flashes twice.

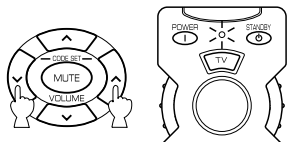

4. Use the numeric buttons to enter the four-digit manufacturer's code for the component to be used. Make sure that the indicator flashes twice. If the indicator does not flash, repeat step 3 and re-enter the code.

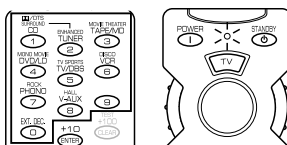

5. Press **POWER** (or any other button) on the remote control to check if you have preset the code correctly. If the component cannot be controlled with the remote control, try entering another code for the same manufacturer.

To use a second (and third) VCR

You can use the CBL/DBS and/or DVD MENU positions to control a second (and/or third) VCR if a CBL (or DBS) or DVD player is not being used.

If you are using the DVD MENU position for a second (or third) VCR, you must preset the code for an LD player to the DVD/LD position.

1. Turn on the VCR to be used.
2. Set the SELECTOR DIAL to the CBL/DBS or DVD MENU position.

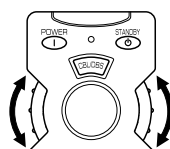

3. Press both **VOLUME** buttons (^ v) for about four seconds at the same time so that the indicator flashes twice.

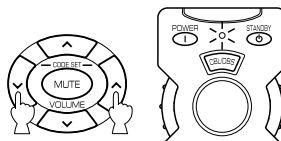

4. Press **MUTE**.

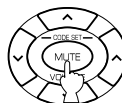

5. Use the numeric buttons to enter the four-digit code for the second (or third) VCR. Make sure that the indicator flashes twice. If the indicator does not flash, repeat steps 3 and 4, and re-enter the code.

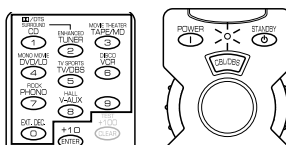

6. Press **POWER** (or any other button) on the remote control to check if you have preset the code correctly. If the VCR cannot be controlled with the remote control, try entering another code for the same manufacturer.

Returning to the factory-set codes

To return all components to the factory-set codes, follow these steps.

1. Set the SELECTOR DIAL to a position other than the AMP/TUN or DSP position.
2. Press both **VOLUME** buttons (^ v) for about four seconds at the same time so that the indicator flashes twice.
3. Enter code number "9987".
4. Make sure that the indicator flashes twice.

To return each component to the factory-set code, follow these steps.

1. Set the SELECTOR DIAL to the position for the component to be returned to the factory-set code.
2. Press both **VOLUME** buttons (^ v) for about four seconds at the same time so that the indicator flashes twice.
3. Enter code number "9999".
4. Make sure that the indicator flashes twice.

The following codes are preset as the factory settings.

Factory-set codes

POSITION	Component	Code ^{*1}	Code ^{*2}
TV	TV	0037	0047
CBL/DBS	DBS tuner	2455	2566
VCR	VCR	3072	3060
DVD/LD	DVD player	4545	YAMAHA
CD	CD player	6187	YAMAHA
TAPE/MD	Tape deck	8524	YAMAHA

*1: Australia model

*2: U.S.A., Canada and China models

We recommend that you write all the code numbers you have preset on the "Quick Reference Card."

TROUBLESHOOTING

If the unit fails to operate normally, check the following points to determine whether the fault can be corrected by the simple measures suggested. If it cannot be corrected, or if the fault is not listed in the SYMPTOM column, disconnect the power cord and contact your authorized YAMAHA dealer or service center for help.

	SYMPTOM	CAUSE	REMEDY
Amplifier	The unit fails to turn on when STANDBY/ON is pressed, or set in the standby mode suddenly soon after the power has been turned on.	The power cord is not plugged in or the plug is not completely inserted.	Firmly plug in the power cord.
		The IMPEDANCE SELECTOR switch on the rear panel is not fully set to the upper or lower end.	Set the switch fully to the upper or lower end when the unit is in the standby mode.
	The unit does not work normally.	The internal microcomputer has been frozen by an external electric shock (lightning, excessive static electricity, etc.) or by a power supply with low voltage.	Set the unit in the standby mode and disconnect the AC power cord from the AC outlet. After about 30 seconds have passed, connect the power and operate the unit again.
	No sound or no picture.	Incorrect output cord connections.	Connect the cords properly. If the problem persists, the cords may be defective.
		An appropriate input source has not been selected.	Select an appropriate input source with INPUT or TAPE/MD MON / EXT. DECODER .
		SPEAKERS have not been set properly.	Set SPEAKERS corresponding to the speakers in use to the ON position.
		The speaker connections are not secure.	Secure the connections.
		Digital signals other than PCM audio and Dolby Digital or DTS encoded signals which this unit cannot reproduce are input to this unit by playing a CD-ROM etc.	Play a source whose signals this unit can reproduce.
	No picture.	There is no S video terminal connection between this unit and the TV, although S video signals are input to this unit.	Connect this unit's S VIDEO MONITOR OUT terminal to the TV's S video input terminal.
	The sound suddenly goes off.	The protection circuit has been activated because of a short circuit, etc.	Set the unit in the standby mode and then switch on again to reset the protection circuit.
		The SLEEP timer has functioned.	Turn on the power, and play the source again.
	Only the speakers on one side can be heard.	Incorrect setting of BALANCE .	Adjust it to the appropriate position.
		Incorrect cord connections.	Connect the cords properly. If the problem persists, the cords may be defective.
	A "humming" sound can be heard.	Incorrect cord connections.	Firmly connect the audio plugs. If the problem persists, the cords may be defective.
		No connection from the turntable to the GND terminal.	Make the GND connection between the turntable and this unit.
The volume level is low while playing a record.	The record is being played on a turntable with an MC cartridge.	The turntable should be connected to the unit through the MC head amplifier.	
The volume level cannot be increased, or the sound is distorted.	The component connected to the REC OUT terminals of this unit is in the standby mode.	Turn on the power to the component.	

	SYMPTOM	CAUSE	REMEDY
Amplifier	No sound from the effect speakers.	The sound effect setting is off.	Press EFFECT on the front panel or EFCT ON/OFF on the remote control to turn it on.
		A Dolby Surround or DTS decoding program is being used with material not encoded with Dolby Surround or DTS.	Use a different sound field program.
	No sound from the rear speakers.	The sound output level of the rear speakers is set to minimum.	Raise the sound output level of the rear speakers.
		A monaural sound source is being played in the DOLBY PRO LOGIC or DOLBY PRO LOGIC ENHANCED program.	Select another sound field program suitable for the monaural sound source.
	No sound from the center speaker.	The sound output level of the center speaker is set to minimum.	Raise the sound output level of the center speaker.
		The function "CNTR" in the SET MENU is set to the NONE position.	Select the LARGE or SMALL position.
		Incorrect sound field program selection.	Select the appropriate program.
		The input signals of the source encoded with Dolby Digital or DTS do not have center channel signals.	Refer to the instructions for the source being currently played.
	The sound field cannot be recorded.	It is not possible to record the sound field on a tape deck or MD recorder connected to the unit's REC OUT terminals.	
	The DVD/LD, TV or DBS source cannot be recorded on a tape deck, MD recorder or VCR connected to this unit.	The DVD/LD player, TV or DBS tuner is connected to the unit by only the digital terminals.	Make additional connections between the analog terminals.
FM	FM stereo reception is noisy.	The characteristics of FM stereo broadcasts may cause this problem when the transmitter is too far away or the antenna input is poor.	Check the antenna connections. Try using a high-quality directional FM antenna. Set TUNING MODE to the manual tuning mode.
	There is distortion and clear reception cannot be obtained even with a good FM antenna.	There is multipath interference.	Adjust the antenna position to eliminate multipath interference.
	The desired station cannot be tuned in with the automatic tuning method.	The station is too weak.	Use the manual tuning method. Use a high-quality directional FM antenna.
	Previously preset stations can no longer be tuned in.	The unit has been unplugged for a long period.	Repeat the presetting procedure.
AM	The desired station cannot be tuned in with the automatic tuning method.	The signal is weak or the antenna connections are loose.	Tighten the AM loop antenna connections and rotate it for best reception. Use the manual tuning method.
	There are continuous crackling and hissing noises.	Noise will result from lightning, fluorescent lamps, motors, thermostats and other electrical equipment.	Use an outdoor antenna and a ground wire. This will help somewhat, but it is difficult to eliminate all noise.
	There are buzzing and whining noises (especially in the evening).	A television set is being used nearby.	Relocate this unit away from the TV.

	SYMPTOM	CAUSE	REMEDY
Remote control	The remote control does not work.	Direct sunlight or lighting (from an inverter type of fluorescent lamp, etc.) is striking the remote control sensor of this unit.	Change the position of this unit.
		The manufacturer's code has not been set properly.	Set the code again.
		The proper manufacturer's code for the component to be controlled has not been set.	Try entering another code for the same manufacturer.
		The component to be controlled has not been selected.	Set the SELECTOR DIAL to the proper position.
Others	The sound is degraded when listening with the headphones to a CD player or tape deck that is connected to this unit.	This unit is in the standby mode.	Turn on the power of the unit.
	There is noise interference from digital or high-frequency equipment or the unit.	The unit is too close to the digital or high-frequency equipment.	Move the unit further away from such equipment.

When playing back a source encoded with DTS

SYMPTOM	CAUSE	REMEDY
A loud hissing noise is heard when you play back a source encoded with DTS.	The player which plays back the source is not connected to a digital audio signal input terminal of this unit.	The player must be connected to a digital audio signal input terminal of this unit besides the analog audio signal terminal connections.
	The ANALOG input mode is selected on this unit.	Select a proper input mode on this unit to turn on the DTS decoder built into the unit.
A percussive noise is heard when you begin playing back a source encoded with DTS.	If the AUTO input mode is selected, depending on some sources, there may be a case that a noise is heard while this unit is identifying the format of the input signal.	Set the input mode of the currently selected input source to DTS.
No sound is heard when you play back a source encoded with DTS, even though the AUTO input mode is selected on this unit.	The DTS decoder built into this unit does not function because the player has a digital volume control and it is set at a position other than "maximum," "neutral" or "ineffective."	Set the player's digital volume control at the maximum, neutral or ineffective position.
No sound is heard when you play back an MD or DAT on to which you have recorded a source encoded with DTS.	A source encoded with DTS cannot be recorded on to an MD or DAT.	
No sound is heard when you play back a source (CD, etc.) even though the currently selected input mode is AUTO.	In the AUTO mode, the DTS-decoding mode cannot be automatically changed to the normal (PCM) digital signal input mode.	Press INPUT MODE on the front panel or INPUT (for the currently selected source) on the remote control so that AUTO appears on the display.

Notes

- It is necessary to use a DTS decoder to play back a source encoded with DTS, so the player which plays back the source must be connected to a digital audio input terminal of this unit in the way described in this manual. If this connection is not made or only a D-to-A converter is being used without using a DTS decoder, when you play back the source, only a loud hissing noise will be heard.
- If you make a search (or skip, etc.) operation while playing back a source encoded with DTS, the "dts" indicator goes out from the display. This is because this unit automatically changes the DTS-decoding mode to the standard (PCM) digital signal input mode to prevent a noise from being output.

SPECIFICATIONS

AUDIO SECTION

Minimum RMS Output Power

8 ohms, 20 Hz to 20 kHz, 0.04% THD
[U.S.A. and Canada models]

MAIN L/R	70 W + 70 W
CENTER	70 W
REAR L/R	70 W + 70 W

[Australia, Singapore, China and General models]

MAIN L/R	65 W + 65 W
CENTER	65 W
REAR L/R	65 W + 65 W

8 ohms, 1 kHz, 0.07% THD
[U.S.A. and Canada models]

MAIN L/R	85 W + 85 W
CENTER	85 W
REAR L/R	85 W + 85 W

[Australia, Singapore, China and General models]

MAIN L/R	80 W + 80 W
CENTER	80 W
REAR L/R	80 W + 80 W

Maximum Power

[China and General models only]

8 ohms, 1 kHz, 10% THD

MAIN L/R	105 W + 105 W
CENTER	105 W
REAR L/R	105 W + 105 W

Dynamic Power per Channel

(by IHF Dynamic Headroom measuring method)

MAIN L/R
8/6/4/2 ohms
[U.S.A. and Canada models]

	100/120/145/170 W
--	-------------------

[Australia, Singapore, China and General models]

	90/110/135/160 W
--	------------------

Dynamic Headroom (8 ohms)

[U.S.A. and Canada models only] ... 1.55 dB

Power Band Width

MAIN L/R
8 ohms, 35 W, 0.1% THD

	10 Hz to 50 kHz
--	-----------------

Damping Factor (SPEAKER A)

8 ohms, 20 Hz to 20 kHz 60 or more

Input Sensitivity/Impedance

PHONO MM	2.5 mV/47 k-ohms
CD/TAPE-MD/DVD-LD/TV-DBS/VCR/	
VIDEO AUX	150 mV/47 k-ohms
EXT. DECODER	
MAIN L/R	150 mV/47 k-ohms
CENTER/SURROUND L/R/SUBWOOFER	
	150 mV/40 k-ohms

Maximum Input Signal

PHONO MM	
1 kHz, 0.1% THD	100 mV or more
CD/TAPE-MD/DVD-LD/TV-DBS/VCR/	
VIDEO AUX (EFFECT ON)	
1 kHz, 0.5% THD	2.2V or more

Output Level/Impedance

REC OUT	150 mV/1.2 k-ohms
SUBWOOFER	
(MAIN SP: SMALL)	4.0 V/1.2 k-ohms

Headphones Jack Rated Output/Impedance

CD/TAPE-MD/DVD-LD/TV-DBS/VCR/	
VIDEO AUX input,	
1 kHz, 150 mV, 8 ohms	0.5 V/390 ohms

Frequency Response (20 Hz to 20 kHz)

CD/TAPE-MD/DVD-LD/TV-DBS/VCR/	
VIDEO AUX to MAIN L/R SP OUT	
	0±0.5 dB

RIAA Equalization Deviation

PHONO MM	0±0.5 dB
----------	----------

Total Harmonic Distortion (20 Hz to 20 kHz)

PHONO MM to REC OUT	
1 V	0.02% or less
CD/TAPE-MD/DVD-LD/TV-DBS/VCR/	
VIDEO AUX (EFFECT OFF) to MAIN SP OUT	
35 W/8 ohms	0.025% or less

Signal-to-Noise Ratio (IHF-A Network)

PHONO MM to REC OUT	
(5 mV, Input Shorted)	
[U.S.A., Canada, China and General models]	86 dB or more
[Australia and Singapore models]	81 dB or more
CD/TAPE-MD/DVD-LD/TV-DBS/VCR/	
VIDEO AUX (EFFECT OFF) to MAIN SP OUT	
(150 mV, Input Shorted)	96 dB or more

Residual Noise (IHF-A Network)

MAIN L/R SP OUT	150 µV or less
-----------------	----------------

Channel Separation

(Vol. -30 dB, EFFECT OFF)

PHONO MM	
(Input Shorted, 1 kHz/10 kHz)	
	60 dB or more/55 dB or more
CD/TAPE-MD/DVD-LD/TV-DBS/VCR/	
VIDEO AUX	
(Input 5.1 k-ohms Terminated, 1 kHz/10 kHz)	
	60 dB or more/45 dB or more

Tone Control Characteristics

BASS: Boost/cut	±10 dB (50 Hz)
Turnover Frequency	350 Hz
TREBLE: Boost/cut	±10 dB (20 kHz)
Turnover Frequency	3.5 kHz

Filter Characteristics

MAIN L/R, REAR L/R (SPEAKER: SMALL)	
(H.P.F.)	fc = 90 Hz, 12 dB/oct.
SUBWOOFER	
(L.P.F.)	fc = 90 Hz, 18 dB/oct.

VIDEO SECTION

Video Signal Type

[U.S.A. and Canada models]	NTSC
[Australia and Singapore models]	PAL
[China and General models]	NTSC/PAL

Video Signal Level 1 Vp-p/75 ohms

S-Video Signal Level

Y	1 Vp-p/75 ohms
C	0.286 Vp-p/75 ohms

Maximum Input Level 1.5 Vp-p or more

Signal-to-Noise Ratio 50 dB or more

Monitor Out Frequency Response

..... 5 Hz to 10 MHz, -3 dB

FM SECTION

Tuning Range

[U.S.A. and Canada models]	87.5 to 107.9 MHz
[Australia and Singapore models]	87.50 to 108.00 MHz
[China and General models]	100 kHz step 87.5 to 108.0 MHz
	50 kHz step 87.50 to 108.00 MHz

50 dB Quieting Sensitivity (IHF)

(100% mod., 1 kHz)

[U.S.A., Canada, China and General models only]	
Mono	1.6 μ V (15.3 dBf)
Stereo	23 μ V (38.5 dBf)

Usable Sensitivity (DIN)

[Australia and Singapore models only]	
Mono (S/N 26 dB)	0.9 μ V
Stereo (S/N 46 dB)	28 μ V

Alternate Channel Selectivity (\pm 400 kHz)

[U.S.A., Canada, China and General models only]	75 dB
---	-------

Selectivity (two signals, 40 kHz Dev. \pm 300 kHz)

[Australia and Singapore models only]	55 dB
---------------------------------------	-------

Signal-to-Noise Ratio

[U.S.A., Canada, China and General models]	
(IHF) Mono/Stereo	81 dB/75 dB
[Australia and Singapore models]	
(DIN-Weighted, 40 kHz Dev.) Mono/Stereo	75 dB/69 dB

Harmonic Distortion (1 kHz)

Mono/Stereo	0.1/0.2%
-------------	----------

Stereo Separation (1 kHz) 48 dB

Frequency Response

20 Hz to 15 kHz	0 \pm 1 dB
-----------------	--------------

Antenna Input 75 ohms, Unbalanced

Output Level

[U.S.A., Canada, China and General models]	
(100% mod., 1 kHz)	550 mV
[Australia and Singapore models]	
(40 kHz Dev., 1 kHz)	550 mV

AM SECTION

Tuning Range

[U.S.A. and Canada models]	530 to 1,710 kHz
[Australia and Singapore models]	531 to 1,611 kHz
[China and General models]	10 kHz step 530 to 1,710 kHz
	9 kHz step 531 to 1,611 kHz

Usable Sensitivity 300 μ V/m

Signal-to-Noise Ratio 52 dB

Antenna Loop antenna

Output Level

(30% mod., 1 kHz)	150 mV
-------------------	--------

GENERAL

Power Supply

[U.S.A. and Canada models]	AC 120 V, 60 Hz
[Australia model]	AC 240 V, 50 Hz
[General model]	AC 110/120/220/240 V, 50/60 Hz
[China model]	AC 220 V, 50 Hz
[Singapore model]	AC 230 V, 50 Hz

Power Consumption

[U.S.A. model]	280 W
[Canada model]	310 W/410 VA
[Australia and Singapore models]	300 W
[China and General models]	310 W

Maximum Power Consumption

[General model only]	
5 ch, 10% THD	650 W

AC Outlets

2 SWITCHED OUTLETS

[U.S.A., Canada, Singapore, China and General models] 100 W max. total

1 SWITCHED OUTLET

[Australia model] 100 W max.

Dimensions (W x H x D)

	435 x 151 x 391 mm
	(17-1/8" x 5-15/16" x 15-3/8")

Weight 12.5 kg (27 lbs. 8 oz.)

Accessories

AM loop antenna

Indoor FM antenna

Remote control

Batteries

Antenna adapter

(U.S.A. and Canada models only)

Specifications are subject to change without notice.

LIST OF MANUFACTURERS' CODES (Australia model)
LISTES DES CODES FABRICANT (Modèle pour l'Australie)

TV		Erres	0037, 0012	Luxor	0349, 0361	Quasar	0250
Abex	0032	Expert	0206	M Electronic	0037, 0217,	Quelle	0037, 0010, 0554,
Acura	0009	Ferguson	0037, 0109, 0005,		0374, 0009,		0011, 0070, 0074,
Admiral	0093, 0163, 0213		0073, 0190, 0238,		0109, 0068,		0084, 0200, 0213,
Adyson	0217, 0032	Fidelity	0287, 0335, 0343		0105, 0163,		0306, 0327,
Akai	0208, 0361	Finlandia			0287, 0346		0328, 0361
Akura	0218, 0264, 0369	Finlux	0216, 0361	MGA	0150	Questa	0036
Alaron	0216		0208, 0346, 0359	MTC	0216, 0349	R-Line	0037
Alba	0037, 0218, 0371,	Firstline	0037, 0072, 0070,	Magnadyne	0102, 0247	RBM	0070
	0009, 0036, 0235		0105, 0346	Magnafon	0102, 0076, 0213	RCA	0090, 0093
Allorgan	0294	Fisher	0216, 0217, 0294,	Magnavox	0036	Radio Shack	0032
Amplivision	0217	Flint	0009, 0321, 0247	Manesth	0217, 0320,	Radiola	0037, 0012, 0323
Amstrad	0371, 0009,	Formenti	0370, 0217, 0208, 0303		0264, 0235	Rank Arena	0036
	0362, 0369	Frontech	0455	Marantz	0037	Realistic	0032
Anam	0009, 0068		0037, 0320, 0213	Mark	0037	Rediffusion	0361
Anitech	0009, 0068, 0076	Fujitsu	0264, 0431,	Matsui	0037, 0217, 0371, 0294,	Revox	0037
Arcam	0216, 0217	Funai	0163, 0247		0009, 0072, 0036, 0035,	Rex	0206, 0264, 0163, 0259
Asberg	0076	GE	0072, 0206		0011, 0208, 0235	Rhapsody	0216
Asuka	0218	GEC	0294, 0264, 0303	Matsushita	0250	Roadstar	0218, 0418,
Atlantic	0206		0282, 0093	McMichael	0043		0009, 0264
Audiosonic	0037, 0109	GPM	0037, 0217, 0072,	Mediator	0037, 0012	SBR	0037, 0012, 0043
Autovox	0206, 0076, 0336	Geloso	0043, 0205	Memorex	0009, 0250, 0150	SEG	0217, 0264, 0036, 0076
BPL	0282	Genexxa	0218, 0218	Memphis	0337	SEI	0294, 0102, 0213
BSR	0294	GoldStar	0218, 0163	Metz	0213, 0367	Saba	0109, 0075, 0163,
BTC	0218		0037, 0217, 0109,	Midland	0032		0196, 0198, 0205,
Baird	0343	Goodmans	0032, 0290	Minerva	0554, 0070		0213, 0287,
Basic Line	0218, 0009		0037, 0217, 0374,	Minoka	0369	Saccs	0335, 0343
Baur	0037, 0010, 0554,		0371, 0072, 0036,	Mitsubishi	0036, 0093, 0108, 0150	Saisho	0238
	0349, 0361	Gorenje	0235, 0317, 0343	Mivar	0216, 0290, 0291, 0292		0009, 0264, 0431,
Beko	0370	Gradiente	0370	Motion	0076	Salora	0011, 0235
Beon	0037		0053	Motorola	0093		0163, 0349, 0359, 0361
Binatone	0217	Graetz	0163, 0361	Multitech	0216, 0217, 0009,	Sambers	0102, 0076, 0213
Blaupunkt	0554, 0191, 0195,	Granada	0037, 0217, 0072,	NEC	0102, 0076	Sampo	0032
	0200, 0213,		0146, 0208,	NEI	0455, 0036	Samsung	0037, 0370, 0217,
	0327, 0328	Grandin	0339, 0359	Neckermann	0037, 0431, 0337		0009, 0264, 0032,
Blue Sky	0218	Grundig	0282		0037, 0554, 0191,	Sandra	0090, 0290
Blue Star	0282		0037, 0554, 0070,	Nikkai	0213, 0349		0216
Bondstec	0247	HCM	0191, 0195, 0205		0037, 0216, 0218, 0072,	Sanyo	0072, 0036, 0011,
Boots	0217	Hanseatic	0009, 0282		0264, 0035, 0032, 0337		0146, 0157, 0208,
Brandt	0109, 0196, 0198,	Harley Davidson	0037, 0320, 0361	Nikko	0317		0213, 0339
	0205, 0333, 0335	Harvard	0043	Nobliiko	0102, 0076	Schaub Lorenz	0361
Brionvega	0362	Hinari	0068	Nokia	0361	Schneider	0037, 0218, 0371,
Britannia	0216	Hisawa	0037, 0218, 0009, 0036	Nordmende	0109, 0196, 0198,		0247, 0303, 0323,
Bush	0037, 0218, 0374,	Hitachi	0282, 0455		0213, 0287, 0343	Sears	0336, 0352
	0371, 0294, 0009,		0217, 0036, 0109,	Oceanic	0163, 0215, 0361	Sei-Sinudyne	0146
	0282, 0036, 0349		0032, 0043, 0044,	Optimus	0250		0010
CCE	0037, 0217		0105, 0163, 0196,	Optonica	0093	Seleco	0206, 0163, 0259, 0362
CGE	0074, 0076, 0084,		0198, 0225,	Orion	0037, 0294, 0320,	Sentra	0035
	0247, 0306	Huanyu	0306, 0349	Osaki	0321, 0235	Sharp	0036, 0093, 0157
CS Electronics	0216		0216, 0374		0217, 0218, 0072,	Shorai	0294
CTC	0247	Hypson	0037, 0282, 0264		0264, 0032	Siarem	0102, 0213
Carrefour	0036	ICE	0217, 0371, 0264	Oso	0218	Siemens	0037, 0554, 0157,
Cascade	0009	ICeS	0218	Osume	0072, 0032, 0157		0191, 0195, 0200,
Cathay	0037	ITS	0371	Otake	0317		0213, 0327, 0328
Centurion	0037	ITT	0163, 0361	Otto Versand	0037, 0217,	Silver	0036
Century	0213	Imperial	0370, 0418, 0074,		0320, 0036,	Sinudyne	0294, 0102,
Cimline	0009		0076, 0084, 0247		0010, 0554,		0213, 0235
Clarivox	0037	Indiana	0037		0191, 0213,	Solavox	0032, 0163
Clatronc	0370, 0076, 0247	Ingelen	0163	Palladium	0343, 0349	Sonitron	0208
Condor	0370, 0320	Inno Hit	0072	Panama	0370, 0418	Sonoko	0037, 0009
Contec	0216, 0009, 0036, 0157	Interbuy	0068	Panasonic	0217, 0264	Sonolor	0163, 0208, 0215
Continental Edison	0196, 0198,	Interfunk	0037, 0163,		0250, 0163, 0213,	Sontec	0037
	0205, 0333		0247, 0361	Pathe Cinema	0214, 0226, 0367	Sony	0036, 0010, 0011
Crosley	0074, 0076, 0084, 0213	Intervision	0037, 0217, 0264,		0216, 0320,	Soundwave	0037, 0418
Crown	0037, 0370, 0418,		0102, 0068	Pathe Marconi	0213, 0238	Standard	0217, 0218, 0009
	0009, 0076	Isukai	0218		0196, 0198,	Stern	0206, 0163, 0259
Crystal	0431	JVC	0371, 0036, 0053,		0205, 0333	Sunkai	0294, 0321
Curtis Mathes	0093		0190, 0192	Pausa	0009	Susumu	0218
Cybertron	0218	KTV	0217	Penney	0032	Sysline	0037
Daewoo	0037, 0374, 0009	Kaisui	0216, 0217, 0218,	Perdio	0320	Tandy	0217, 0218, 0072,
	0218, 0215		0009, 0282	Phase	0032		0093, 0163
Dainichi	0037	Kamp	0216	Philco	0074, 0076, 0084,	Tashiko	0217, 0036, 0043, 0359
Dansai	0009	Kapsch	0206, 0163		0213, 0247	Tatung	0037, 0217, 0072
Dayton	0009	Kawasho	0216	Philips	0037, 0374, 0554,	Tec	0217, 0247
De Graaf	0208	Kendo	0037, 0235, 0362		0012, 0043, 0323	Technema	0320
Decca	0037, 0072	Kingsley	0216	Phonola	0037, 0012	Technics	0250
Dixi	0037, 0009	Kneissel	0259	Pioneer	0109, 0163, 0287	Teknika	0150
Dual	0336, 0352	Korpel	0037	Profex	0009, 0076, 0361	Teleavia	0205, 0333, 0343
Dual Tec	0217	Koyoda	0009	Proline	0321	Telefunken	0109, 0005, 0074,
Dumont	0070	Leyco	0037, 0294, 0072, 0264	Protech	0037, 0217, 0418,		0084, 0101, 0213,
Elbe	0259	Liesenk & Tter	0037		0009, 0264, 0102,		0262, 0306,
Elin	0037	Lloytron	0032	Pye	0431, 0247, 0337		0335, 0343
Elite	0218, 0320	Loewe	0075		0012	Telemeister	0320
Elta	0009	Luma	0206			Teletech	0009
Emerson	0282, 0213, 0361					Teleton	0217, 0206, 0349

Tensai	0218, 0294, 0320, 0317	Armstrong	2243	Nordmende	2362	Blaupunkt	3034, 3226, 3195,
Texet	0216, 0218	Astra	2108, 2539	Orbitech	2501		3003, 3006, 3154,
Thomson	0109, 0196, 0198,	Astro	2520, 2173, 2358, 2501	Oxford	2344		3162, 3227, 3403
	0205, 0287, 0333,	Avalon	2396	Pace	2455, 2183, 2067,	Brandt	3320, 3187, 3321
	0343, 0349	Axis	2369, 2530		2328, 2336, 2791	Brandt Electronic	3041
Thorn	0037, 0072, 0035, 0074,	BT	2668	Palcom	2297	Broksonic	3209
	0084, 0190, 0192, 0361	Barcom	2217	Palladium	2571	Bush	3072, 3278, 3209, 3352
Thorn-Ferguson	0343	Beko	2189	Palsat	2501	CCE	3072, 3278
Tomashi	0282	Best	2369, 2217	Panda	2455	CGE	3000
Toshiba	0036, 0035, 0070, 0243	Blaupunkt	2173	Philips	2455, 2571, 2200,	Calix	3037
Trical	0157	Boca	2243, 2513		2292, 2328	Capehart	3020
Triumph	0243	Brain Wave	2332	Phonotrend	2288, 2592	Carver	3081
Uher	0206, 0320, 0303	Bush	2067	Planet	2871	Catron	3020
Ultra	0192	CNT	2520	Plasmatic	2442	Cimline	3072
Ultravox	0102	Cambridge	2344	Polytron	2394	Cineral	3278
Universum	0037, 0370, 0264,	Channel Master	2362	Promax	2455	Citizen	3037, 3278
	0105, 0346	Chaparral	2053, 2209	Prosat	2288	Clatronic	3020
Vestel	0037	CityCom	2394	Quadral	2362, 2519	Colt	3072
Victor	0053	Commlink	2288	RFT	2288, 2220, 2200	Combitech	3352
Videosat	0247	Connexions	2396	Radiola	2200	Condor	3020
Videotechnic	0217	Crown	2243	Radix	2396, 2882	Craig	3072, 3037, 3047, 3240
Vidtech	0036	Cyrus	2200	SAT	2321, 2351, 2461	Crown	3072, 3020, 3278
Vision	0320	D-box	2723	SEG	2421, 2369, 2539	Curtis Mathes	3041, 3162
Voxson	0163	DDC	2362	STVI	2417	Cybernex	3240
Waltham	0217	DNT	2396, 2200	Saba	2520, 2336	Cyrus	3081
Watson	0037, 0320	Diskxpress	2217	Sabre	2455	Daewoo	3020, 3278, 3045
Watt Radio	0102	Drake	2268	Sagem	2820	Dansai	3072
Wega	0036	EIF	2417	Salora	2108	Daytron	3020
White Westinghouse	0037, 0216,	Echostar	2396, 2871	Samsung	2287	De Graaf	3042, 3166
	0320	Emanon	2421	SatPartner	2421, 2332, 2520,	Decca	3000, 3081
Yoko	0037, 0217, 0264, 0431	FTE	2331		2502, 2335, 2692	Denon	3042
Zanussi	0206	Ferguson	2183, 2067,	Satcom	2605, 2346	Dual	3041
			2189, 2336	Satec	2183, 2328	Dumont	3000, 3081, 3104
		Fidelity	2252	Satmaster	2346	Dynatech	3000
CABLE		Finlux	2455, 2108, 2344, 2397	Schwaiger	2183, 2394, 2504	ESC	3278, 3240
ABC	1003, 1008, 1014, 1017	Fracarro	2871	Seemann	2396, 2530	Elbe	3038
Birmingham Cable		Freecom	2421, 2335	Siemens	2173	Elcotech	3072
Communications	1276	Fuba	2421, 2369, 2396,	Skymaster	2288, 2605, 2519	Electrohome	3037
British Telecom	1003, 1105		2217, 2297, 2417	Star Trak	2421	Electrohome	3037
Cabletime	1161, 1271, 1377	G-Sat	2183	Strong	2421	Emerex	3032
Clyde	1086	Galaxis	2288, 2834, 2863	Sunstar	2513	Emerson	3000, 3037, 3278,
Contec	1019	Galaxisat	2321	TPS	2820		3209, 3036,
Decsat	1423	GoldStar	2335	Tantec	2455, 2297, 2336		3043, 3088
Filmnet	1443	Gooding	2571	TechniSat	2262, 2501	Ferguson	3320, 3041,
France Telecom	1451	Goodmans	2189	Techniland	2346		3107, 3321
GEC	1086	Grothusen	2335	Telefunken	2421	Fidelity	3000
General Instrument	1276	Grundig	2571, 2173,	Teleka	2243, 2613	Finlandia	3081, 3104
GoldStar	1144		2189, 2328	Telesat	2605	Finlux	3000, 3081, 3042, 3104
Jerrold	1003, 1276, 1014	Harting und Helling	2333	Thomson	2455	Firstline	3072, 3037, 3209,
MNet	1443, 1019	Hinari	2183	Tonna	2668, 2346		3045, 3043
Magnavox	1032	Hirschmann	2502, 2173, 2573,	Triad	2321, 2333, 2335, 2351	Fisher	3046, 3047, 3054, 3104
Memorex	1000		2287, 2333,	Triasat	2501	Frontech	3020
Movie Time	1156		2397, 2398	Unitor	2332, 2217	Fuji	3033
NSC	1156	Hitachi	2455	Universum	2571, 2173	Funai	3000
Oak	1019	Houston	2668	Vector	2333	GE	3048, 3240
PVP Stereo Visual Matrix	1003	Huth	2243, 2288, 2220, 2346	Ventana	2200	GEC	3081
Panasonic	1000	ITT	2108	Vortec	2421	Garrard	3000
Paragon	1000	InVideo	2871	Vtech	2351	General	3020
Pioneer	1144, 1260	Intervision	2592	Wevasat	2333	Go Video	3432
Pulsar	1000	JVC	2571	Winersat	2332	GoldHand	3072
Runco	1000	Johansson	2332	Wisi	2455, 2396, 2173, 2321,	GoldStar	3037, 3038, 3225
STS	1156	Kathrein	2173, 2200, 2092,		2351, 2372, 2406, 2407	Goodmans	3072, 3000, 3020,
Salora	1382		2331, 2358, 2394,	XSat	2889		3037, 3278, 3403
Samsung	1144		2442, 2480, 2504	Xcom Multimedia	2889	Gradiente	3000, 3008
Satbox	1375	Kosmos	2331, 2335	Zehnder	2520, 2321, 2331	Graetz	3005, 3041, 3104, 3240
Scientific Atlanta	1008, 1277,	Kreiselmeier	2173			Granada	3081, 3046, 3104
	1017	Kyostar	2421	VCR		Grandin	3072, 3000, 3037
Starcom	1003	La Sat	2520, 2513, 2464	ASA	3037, 3081	Grundig	3072, 3081, 3347,
Tele+1	1443	Lemon	2692	Admiral	3048		3226, 3195, 3003,
Teleservice	1281	Lenco	2421, 2335	Adventura	3000		3006, 3007, 3207,
Toshiba	1000	Lennox	2592	Aiko	3278	HCM	3349, 3403
Tudi	1286	Lupus	2369	Aiwa	3000, 3037, 3307,	HI-Q	3072
United Cable	1003	Luxor	2573, 2108		3348, 3352	Hanseatic	3037
Videoway	1250	Manhattan	2455, 2592, 2520	Akai	3315, 3106, 3041, 3053	Harley Davidson	3000
Westminster	1105	Marantz	2200	Akiba	3072	Harman/Kardon	3038
Zenith	1000	Maspro	2092, 2328, 2336	Alba	3072, 3020, 3278,	Harwood	3072
		Matsui	2571, 2344		3209, 3315, 3352	Headquarter	3046
		Mediamarkt	2243	Ambassador	3020	Hinari	3072, 3004, 3240, 3352
DBS TUNER		Micro Technology	2333, 2539	Amstrad	3000, 3278,	Hitachi	3000, 3004, 3042, 3041,
AST	2321, 2351	Minerva	2571		3325, 3332		3166, 3235, 3240
Alba	2455, 2421, 2362, 2613	Morgan's	2243, 2513	Anitech	3072	Hypson	3072
Aldes	2288	Multistar	2331, 2464	Asha	3240	ITT	3106, 3046, 3384, 3005,
Allantide	2333	Muratto	2335	Asuka	3037		3041, 3104, 3240
Amstrad	2080, 2252, 2345,	Navex	2332	Audiovox	3037	ITV	3037, 3278
	2461, 2501	Neuhaus	2501	Baird	3000, 3041, 3104, 3107	Imperial	3000
Ankaro	2369, 2288, 2220,	Neusat	2692, 2834	Basic Line	3072, 3020, 3278	Ingorsol	3004
	2519, 2217	Newhaus	2220	Beaumark	3240	Interfunk	3081
Anttron	2421, 2183	Nikko	2360	Bell & Howell	3104	JVC	3067, 3384, 3008, 3041,
Arcon	2368	Nokia	2455, 2573, 2108,				3206, 3207, 3486
			2328, 2397, 2873				

Jensen	3041	Radio Shack	3000, 3037
KEC	3037, 3278	Radiola	3081
KLH	3072	Radix	3037
Kaisui	3072	Randex	3037
Kendo	3209, 3106	Realistic	3000, 3037, 3048, 3046, 3047, 3104
Kenwood	3067, 3384, 3038, 3041	Rex	3384, 3041
Kodak	3037	Ricoh	3034
Korpel	3072	Roadstar	3072, 3037, 3278, 3240
LXI	3037	SBR	3081
Lenco	3278	SEG	3322, 3240
Leyco	3072	SEI	3004, 3081
Lloyd's	3000	STS	3042
Loewe	3037, 3004, 3081, 3006	Saba	3320, 3384, 3041, 3206, 3207, 3297, 3321
Logik	3072, 3004, 3240	Saisho	3209, 3004, 3036, 3088
Luxor	3106, 3048, 3046, 3043, 3104	Salora	3106, 3046, 3043
M Electronic	3000	Samsung	3432, 3045, 3053, 3240
MGA	3043, 3240	Sanky	3048
MGN Technology	3240	Sansui	3000, 3067, 3041
MTC	3000, 3240	Sanyo	3046, 3047, 3104, 3240
Magnasonic	3278	Saville	3352
Magnavox	3000, 3081	Schaub Lorenz	3000, 3005, 3041, 3104
Magnin	3240	Schneider	3072, 3000, 3081
Manesth	3072, 3045	Scott	3045, 3043
Marantz	3081, 3003, 3006	Sears	3000, 3037, 3042, 3046, 3047, 3054, 3104
Marta	3037	Seleco	3041
Matsui	3209, 3004, 3036, 3088, 3348, 3352	Semp	3045
Matsushita	3162	Sentra	3020
Memorex	3000, 3037, 3048, 3046, 3047, 3104, 3162, 3240, 3307	Sharp	3048
Memphis	3072	Shintom	3072, 3104
Metz	3347, 3195, 3003, 3006, 3162, 3227	Shogun	3240
Minerva	3195, 3006	Shorai	3004
Minolta	3042	Siemens	3037, 3081, 3195, 3003, 3006, 3054, 3104
Mitsubishi	3081, 3067, 3048, 3043	Silva	3037
Motorola	3048	Singer	3072, 3045
Multitech	3072, 3000	Sinudyne	3004, 3081
Murphy	3000	Solavox	3020
NEC	3067, 3038, 3041, 3104	Sonolor	3046
Neckermann	3081	Sontec	3037
Nesco	3072	Sony	3000, 3032, 3033, 3034, 3011
Nikko	3037	Sunkai	3348
Nikon	3034	Sunstar	3000
Noblex	3240	Suntronic	3000
Nokia	3106, 3046, 3041, 3104, 3240	Sylvania	3000, 3081, 3043
Nordmende	3320, 3384, 3041, 3297, 3321	Symphonic	3000
Oceanic	3000, 3041	TMK	3036, 3240
Okano	3315, 3348	Tashiko	3000
Olympus	3226	Tatung	3000, 3081, 3041
Optimus	3037, 3432, 3048, 3104, 3162	Teac	3000, 3041
Orion	3209, 3004, 3036, 3088, 3348, 3352	Tec	3020
Osaki	3072, 3000, 3037	Technics	3226, 3162
Otto Versand	3081	Teknika	3000, 3037
Palladium	3072, 3037, 3006, 3041	Teleavia	3041
Panasonic	3226, 3162, 3225, 3227	Telefunken	3320, 3384, 3041, 3187, 3321
Pathe Cinema	3036	Tenosal	3072
Pathe Marconi	3041	Tensai	3322, 3000
Penney	3037, 3042, 3038, 3054, 3240	Thomas	3000
Pentax	3042	Thomson	3320, 3384, 3041
Perdio	3000	Thorn	3036, 3041, 3104
Philco	3209, 3038	Toshiba	3081, 3045, 3384, 3041, 3043
Philips	3081, 3384, 3403	Totevision	3037, 3240
Phonola	3081	Towada	3322
Pilot	3037	Uher	3240
Pioneer	3081, 3067, 3162, 3235	Unitech	3240
Portland	3020	Universum	3000, 3037, 3081, 3106, 3195, 3006, 3240, 3325
Profex	3322	Vector	3045
Profitronic	3240	Vector Research	3038
Proline	3000	Video Concepts	3045
Protec	3072	Videosonic	3240
Pye	3081	Wards	3072, 3000, 3081, 3042, 3048, 3047, 3240
Quarter	3046	White Westinghouse	3278
Quartz	3046	XR-1000	3072, 3000
Quasar	3162	Yamaha	3038
Quelle	3081	Yamishi	3072
RCA	3106, 3042, 3048, 3240	Yokan	3072
RFT	3403	Yoko	3020, 3240
		Zenith	3000, 3033, 3034

DVD PLAYER

Kenwood	4534
Magnavox	4503
Onkyo	4503
Panasonic	4490
Philips	4539, 4503
Pioneer	4525
Sony	4533
Technics	4490
Thomson	4551
Toshiba	4503
Yamaha	4490, 4545
Zenith	4503

LD PLAYER

Aiwa	5203
Carver	5064, 5194
Cyrus	5388
Denon	5059, 5172
Disco Vision	5023
Funai	5203
Hitachi	5023
Magnavox	5194, 5217
Marantz	5064, 5194
Mitsubishi	5059
NAD	5059
Panasonic	5204, 5496
Philips	5064, 5388, 5194
Pioneer	5023, 5059
Quasar	5204
Radiola	5388
Realistic	5203
Salora	5064
Sega	5023
Sharp	5001
Sony	5193, 5201
Technics	5204, 5496
Telefunken	5059
Theta Digital	5194
Thorn	5014
Yamaha	5217

CD PLAYER

Aiwa	6124, 6157, 6419
Akai	6108, 6156, 6199
Alba	6536, 6288, 6334
Arcam	6157
Audio Research	6157
Audio Ton	6157
Audiolab	6157
Audiomeca	6134
BSR	6164
Bestar	6452
Binatone	6029
California Audio Lab	6157, 6179
Carver	6134, 6164
Condor	6157
Cyrus	6000
DKK	6003, 6034
Denon	6196
Dual	6164
Emerson	6048, 6179, 6342
Fisher	6334
GE	6032, 6164
Genexxa	6525, 6383
GoldStar	6536
Goodmans	6157
Grundig	6108, 6173
Harman/Kardon	6032, 6291
Hitachi	6072
JVC	6037, 6523, 6028, 6048, 6190
Kenwood	6287
Kodak	6157
Krell	6157
Linn	6328
Luxman	6525
M Electronic	6029
MCS	6157, 6038, 6129
Magnavox	6157, 6029, 6038, 6129
Marantz	6157, 6288, 6307
Matsui	6287
McIntosh	6032, 6164
Memorex	6157
Meridian	

Micromega	6157
Mission	6157
Mitsubishi	6108, 6156
NAD	6000
NSM	6157
Naim	6157
Nikko	6525, 6164
Onkyo	6101, 6102
Optimus	6000, 6032, 6037, 6536, 6048, 6179, 6196, 6342
Panasonic	6303, 6029, 6367
Philips	6157, 6274, 6287
Pioneer	6032
Poppy	6164
Proton	6157
QED	6157
Quad	6157
Quasar	6029
RCA	6179
Realistic	6164, 6179
Revox	6157, 6113
Roadstar	6461, 6525, 6527
Rotel	6157
SAE	6157
Sansui	6157, 6202, 6513
Sanyo	6048, 6179, 6342
Schneider	6134
Scott	6164
Sharp	6037, 6262, 6265
Sherwood	6114, 6196
Siemens	6516
Signature	6108
Sony	6000, 6490
Teac	6378
Technics	6207, 6303, 6029
Toshiba	6481
Universum	6157
Victor	6072
Wards	6157, 6108
Yamaha	6036, 6082, 6187, 6712
Yorx	6461

MD RECORDER

Kenwood	7826
Sony	7490
Yamaha	7888, 7490

TAPE DECK

Aiwa	8029, 8197, 8200
Akai	8188, 8189
Arcam	8076
Carver	8029
Denon	8076, 8412
Fisher	8074
Grundig	8029
Harman/Kardon	8182
JVC	8244, 8273, 8274
Kenwood	8070, 8071, 8092, 8205, 8233, 8234
Magnavox	8029
Marantz	8029, 8009
Memorex	8099, 8101
Mitsubishi	8189
Onkyo	8136, 8135
Optimus	8027, 8220
Panasonic	8229
Philips	8029
Pioneer	8027, 8099, 8101, 8220
Revox	8029
Sansui	8029, 8009
Sanyo	8074
Sharp	8205
Sony	8170, 8243
Technics	8229
Victor	8273, 8274
Wards	8027
Yamaha	8094, 8097, 8205, 8478, 8524

LIST OF MANUFACTURERS' CODES (U.S.A, Canada and China models)
LISTES DES CODES FABRICANT (Modèles pour les Etats-Unis, le Canada et la Chine)

TV		Elta	0009	MTC	0060, 0030, 0019, 0056,	Revox	0037
A-Mark	0003	Emerson	0154, 0236, 0463,		0185, 0216, 0512	Rex	0264
AOC	0030, 0019, 0003,		0180, 0282, 0178,	Magnavox	0054, 0030, 0179,	Rhapsody	0185, 0216
	0052, 0185		0019, 0179, 0039,		0186, 0187	Roadstar	0009, 0264, 0418
Abex	0032	Envision	0177, 0185, 0280	Majestic	0016	Runco	0017, 0030
Acura	0009	Erres		Manesth	0264	SBR	0037
Admiral	0093	Ferguson		Marantz	0054, 0030, 0037	SEG	0264
Adventura	0046		0037, 0109,	Mark	0037	SEI	0177
Adyson	0032	Fidelity	0287, 0560	Matsui	0009, 0035, 0037,	SSS	0180, 0019
Aiko	0092	Finlandia			0177, 0208	Saba	0109, 0287
Akai	0030, 0208	Finlux		Matsushita	0250	Saisho	0009, 0177, 0264
Akura	0264	Firstline		Mediator	0037	Sampo	0030, 0039, 0032, 0052
Alaron	0179, 0216	Fisher		Megatron	0178, 0145, 0003	Samsung	0060, 0030, 0178,
Alba	0009, 0037	Formenti	0154, 0159, 0208	Memorex	0154, 0250, 0150,		0019, 0056, 0039,
Ambassador	0177	Frontech			0178, 0056,		0009, 0032, 0037,
Amstrad	0009, 0171, 0177	Fujitsu			0016, 0009		0090, 0264, 0427
Anam	0180, 0004, 0009, 0068	Funai		Metz	0535	Samsux	0039
Anam National	0161	Futurtech	0180, 0179, 0171,	Midland	0047, 0017, 0051,	Sandra	0216
Anitech	0009, 0068	GE	0180		0039, 0032, 0135	Sansei	0451
Arcam	0216		0047, 0051, 0451, 0093,	Minerva	0535, 0554	Sansui	0463
Archer	0003	GEC	0282, 0178, 0021, 0135	Minutz	0021	Sanyo	0154, 0159, 0208, 0339
Audinac	0391	Geloso		Mitsubishi	0093, 0150, 0178,	Schneider	0037
Audiosonic	0037, 0109	Gibraltar			0019, 0512, 0535	Scimitsu	0019
Audiovox	0451, 0180,	GoldStar		Mivar	0216	Scotch	0178
	0003, 0092			Motorola	0093	Scott	0236, 0180, 0178,
BPL	0282			Multitech	0180, 0009, 0216		0019, 0179
Basic Line	0009	Goodmans		NAD	0156, 0178, 0166	Sears	0047, 0054, 0154, 0156,
Baur	0037, 0512, 0535, 0554	Gradiente		NEC	0030, 0019, 0056, 0170		0178, 0179, 0056, 0149,
Baysonic	0180	Granada		NEI	0037		0159, 0171
Belcor	0019			NTC	0092	Semivox	0180
Bell & Howell	0154, 0016	Grandin		Neckermann	0037, 0554	Semp	0156
Beon	0037	Grundig		Nesco	0179	Sentra	0035, 0283
Blaupunkt	0535, 0554	Grunpy		Nikkai	0032, 0035, 0037,	Sharp	0093, 0165, 0039
Blue Star	0282	HCM			0216, 0264	Shogun	0019
Bradford	0180	Hallmark		Nikko	0030, 0178, 0092	Siemens	0037, 0535, 0554
Brandt	0109	Hanseatic		Nisato	0391	Signature	0016
Britannia	0216	Harley Davidson		Nordmende	0109, 0287, 0560	Simpson	0186, 0187
Brockwood	0019	Harvard		Noshi	0018	Sinudyne	0177
Broksonic	0236, 0463,	Hinari		Onwa	0180	Solavox	0032
	0003, 0426	Hisawa		Optimus	0154, 0250, 0166	Sonitron	0208
Bush	0282, 0009, 0037	Hitachi		Optonica	0093, 0165	Sonoko	0009, 0037
CCE	0037			Orion	0236, 0463, 0179,	Sonorol	0208
CS Electronics	0216	Huanyu			0037, 0177	Sontec	0037
CXC	0180	Hypson		Osaki	0032, 0264	Sony	0000, 0080
Candle	0030, 0056, 0046, 0186	ICE		Osune	0032	Soundesign	0180, 0178,
Carnivale	0030	ITT		Otto Versand	0037, 0512,		0179, 0186
Carver	0054, 0170	Imperial			0535, 0554	Soundwave	0037, 0418
Cascade	0009	Indiana		Palladium	0418	Spectricon	0003
Cathay	0037	Inteq		Panama	0264	Squareview	0171
Celebrity	0000	Interbuy		Panasonic	0051, 0250, 0226	Standard	0009
Centurion	0037	Interfunk		Pathe Cinema	0216	Starlite	0180
Cimline	0009	Intervision		Pausa	0009	Supra	0056
Cineral	0451, 0092	JBL		Penney	0047, 0156, 0051,	Supre-Macy	0046
Citizen	0060, 0030, 0056, 0039,	JCB			0060, 0030, 0178,	Supreme	0000
	0046, 0092, 0186, 0280	JEC			0021, 0019, 0018,	Sylvania	0054, 0030
Clairtone	0185	JVC			0056, 0039, 0002,	Symphonic	0171
Clarivox	0037	Janeil		Phase	0003, 0032,	Sysline	0037
Concerto	0056	KEC		Philco	0135, 0149	TMK	0178, 0056, 0177
Contec	0180, 0009, 0185, 0216	KTV			0032	Tandy	0093
Craig	0180, 0161	Kaisui		Philips	0054, 0463, 0030,	Tatung	0003, 0037
Crosley	0054	Kamp		Pilot	0145, 0019	Technics	0051, 0250
Crown	0180, 0039, 0009,	Kawasho		Pioneer	0054, 0037, 0554	Technol Ace	0179
	0037, 0418	Kaypani		Portland	0037	Techwood	0051, 0056, 0003
Curtis Mathes	0047, 0054,	Kendo		Prism	0030, 0019, 0039	Teknika	0054, 0180, 0150,
	0154, 0051,	Kenwood		Profex	0109, 0166, 0287		0060, 0019, 0179,
	0451, 0093,	Kingsley		Proscan	0019, 0039, 0092		0056, 0016, 0039,
	0060, 0030,	Kloss		Protech	0051		0092, 0186
	0145, 0056,	Korpel		Proton	0009	Telefunken	0056, 0109, 0252
	0016, 0039,	Koyoda		Pulsar	0047	Teletech	0009
	0166	LG		Quasar	0009, 0037, 0264, 0418	Teleton	0186
Daewoo	0451, 0019, 0039,	LXI		Quelle	0178, 0003, 0052	Texet	0216
	0009, 0037,	Leyco		R-Line	0017, 0019	Thomson	0109, 0287
	0066, 0092	Liesenk & Tter		RCA	0051, 0250, 0165	Thorn	0035, 0037, 0512, 0535
Dansai	0037	Lloytron			0037, 0252, 0512,	Tomashi	0282
Dayton	0009	Loewe			0535, 0554	Toshiba	0154, 0156, 0060,
Daytron	0019	Logik			0037		0035, 0149, 0502
De Graaf	0208	Luxman			0047, 0051, 0093, 0019,	Tosonic	0185
Decca	0037	M Electronic			0018, 0090, 0135	Totevision	0039
Denon	0145	MEI		Radio Shack	0047, 0154, 0165,	Triumph	0177
Dixi	0004, 0009, 0037	MGA			0180, 0030, 0178,	Ultra	0391
Dumont	0017, 0019				0019, 0056,	Universum	0037, 0264, 0535
Ectec	0391				0039, 0032	Vector Research	0030
Electroband	0000, 0185			Radiola	0037	Vestel	0037
Elin	0037			Realistic	0154, 0165, 0180,	Victor	0053
					0030, 0178, 0019,	Vidikron	0054
					0056, 0039, 0032		

Vidtech	0178, 0019	Connexions	2396	Clatronic	3020	Logik	3240, 3072
Viking	0046	DNT	2396	Colt	3072	Luxor	3048, 3104, 3043, 3062, 3046
Wards	0054, 0165, 0030, 0178, 0021, 0019, 0179, 0056, 0016, 0080	Echostar	2396	Condor	3020	M Electronic	3000
Watson	0037	Elta	2364	Craig	3037, 3047, 3240, 3072, 3271	MEI	3035
White Westinghouse	0037, 0216	Expressvu	2775	Crown	3072, 3278, 3020	MGA	3240, 3043, 3061
Yamaha	0030, 0019	Fuba	2396	Curtis Mathes	3060, 3035, 3041, 3162	MGN Technology	3240
Yoko	0037, 0264	Galaxis	2364	Cybernex	3240	MTC	3240, 3000
Zenith	0017, 0016, 0092	Galaxisat	2321	Cyrus	3081	Magnasonic	3278
Zonda	0003	General Instrument	2361	Daewoo	3045, 3278, 3020	Magnavox	3035, 3039, 3081, 3000
<hr/>				Dansai	3072	Magnin	3240
CABLE				Daytron	3020	Manesth	3045, 3072
ABC	1003, 1008, 1014, 1011	Jerrold	2361	De Graaf	3042, 3166	Marantz	3035, 3081, 3062, 3295
Allegro	1315	Lemon	2692	Decca	3081, 3000	Marta	3037
Archer	1797	NEC	2507	Denon	3042	Matsui	3209, 3036, 3208, 3295
BBT	1267	Neusat	2692	Dual	3041	Matsushita	3035, 3162
Belcor	1056	Next-Wave	2732	Dumont	3081, 3000, 3104	Memorex	3035, 3037, 3048, 3039, 3047, 3240, 3000, 3104, 3162, 3046
British Telecom	1003	Primestar	2361	Dynatech	3000	Memphis	3072
Cable Star	1056	Radix	2396	ESC	3240, 3278	Metz	3162, 3195, 3227
Citizen	1315	SAT	2321	Elbe	3038	Minerva	3195
Colour Voice	1031	SatPartner	2692	Elcatech	3072	Minolta	3042
Comtronics	1040	Seemann	2396	Electrohome	3037	Mitsubishi	3048, 3081, 3067, 3043, 3061, 3173, 3196
Contec	1019	Triad	2321	Electrohome	3037	Motorola	3035, 3048
Emerson	1797	Wisi	2321, 2396	Emerex	3032	Multitech	3000, 3072
Everquest	1015, 1040	Zehnder	2321	Emerson	3037, 3184, 3000, 3121, 3043, 3209, 3002, 3278, 3036, 3061, 3068, 3208, 3212, 3295, 3361, 3479	Murphy	3000
Focus	1400	<hr/>				Ferguson	3041, 3320
GC Electronics	1056	(DSS)				Fidelity	3000
Gemini	1015	AlphaStar	2772	Finlandia	3081, 3104	Finlux	3081, 3000, 3042, 3104
General Instrument	1476, 1011	Echostar	2775	Firstline	3037, 3045, 3043, 3209, 3072	Fisher	3047, 3104, 3046, 3054, 3066
GoldStar	1144, 1040	General Instrument	2869	Frontech	3020	Fisher	3047, 3104, 3046, 3054, 3066
Goodmind	1797	HTS	2775	Fuji	3035, 3033	Fisher	3047, 3104, 3046, 3054, 3066
Hamlin	1020, 1259, 1009, 1034	Hitachi	2819	Funai	3000	Frontech	3020
Hitachi	1011	Hughes Network System	2749	GE	3060, 3035, 3048, 3240, 3202	Fuji	3035, 3033
Jasco	1315	Jerrold	2627	GEC	3081	Funai	3000
Jerrold	1003, 1012, 1476, 1014, 1015, 1011, 1024	Magnavox	2724	Garrard	3000	GE	3060, 3035, 3048, 3240, 3202
MNet	1019	Memorex	2724	General	3020	GEC	3081
Magnavox	1027	Panasonic	2701	GoldHand	3072	Garrard	3000
Memorex	1000	Philips	2724	GoldStar	3037, 3038, 3225, 3471	General	3020
Movie Time	1063	Primestar	2627	Goodmans	3037, 3000, 3072, 3278, 3062, 3020	GoldHand	3072
NSC	1063	RCA	2566	Gradiente	3000, 3008	GoldStar	3037, 3038, 3225, 3471
Novaplex	1618	Sony	2639	Graetz	3240, 3104, 3041	Goodmans	3037, 3000, 3072, 3278, 3062, 3020
Oak	1019	Star Choice	2869	Granada	3081, 3104, 3046	Gradiente	3000, 3008
Optimus	1021	Toshiba	2790	Grandin	3037, 3000, 3072	Graetz	3240, 3104, 3041
PVP Stereo Visual Matrix	1003	Uniden	2724	Grundig	3081, 3072, 3195, 3226	Granada	3081, 3104, 3046
Panasonic	1000, 1107, 1021	<hr/>				HCM	3072
Paragon	1000	VCR				HI-Q	3047
Philips	1027, 1031	ASA	3037, 3081	ASA	3037, 3081	Hanseatic	3037
Pioneer	1144, 1533	Admiral	3048	Admiral	3048	Harley Davidson	3000
Popular Mechanics	1400	Adventura	3000	Adventura	3000	Harman/Kardon	3038
Prelude	1770	Aiko	3278	Aiko	3278	Harwood	3072, 3068
Pulsar	1000	Aiwa	3037, 3000	Aiwa	3037, 3000	Headquarter	3046
RCA	1021	Akai	3041, 3061, 3281, 3288	Akai	3041, 3061, 3281, 3288	Hinari	3240, 3072, 3208
Radio Shack	1015, 1315	Akiba	3072	Akiba	3072	Hitachi	3240, 3000, 3042, 3041, 3166, 3235
Recoton	1400	Akura	3271	Alba	3209, 3072, 3278, 3020, 3295	Hypson	3072
Regal	1020, 1259	Alba	3209, 3072, 3278, 3020, 3295	Ambassador	3020	ITT	3240, 3104, 3041, 3046, 3384
Rembrandt	1011	American High	3035	American High	3035	ITV	3037, 3278
Runco	1000	Amstrad	3000, 3278	Amstrad	3000, 3278	Imperial	3000
SL Marx	1040	Anitech	3072	Anitech	3072	Interfunk	3081
Samsung	1144, 1040	Asha	3240	Asha	3240	JVC	3067, 3041, 3008, 3384
Scientific Atlanta	1008, 1477	Asuka	3037	Asuka	3037	Jensen	3041
Signal	1015, 1040	Audiovox	3037	Audiovox	3037	KEC	3037, 3278
Signature	1011	Baird	3000, 3104, 3041	Baird	3000, 3104, 3041	KLH	3072
Sprucer	1021	Basic Line	3072, 3278, 3020	Basic Line	3072, 3278, 3020	Kaisui	3072
StarSight	1422	Beaumarck	3240	Beaumarck	3240	Kendo	3209
Starcom	1003, 1015	Bell & Howell	3104	Bell & Howell	3104	Kenwood	3067, 3041, 3038, 3384
Stargate	1015, 1040, 1770, 1797	Blaupunkt	3162, 3034, 3195, 3226, 3227	Blaupunkt	3162, 3034, 3195, 3226, 3227	Kodak	3035, 3037
Starquest	1015	Brandt	3187, 3320	Brandt	3187, 3320	Korpel	3072
TV86	1063	Brandt Electronic	3041	Brandt Electronic	3041	LXI	3037
TeleCaption	1221	Broksonic	3184, 3121, 3209, 3002, 3295, 3361, 3479	Broksonic	3184, 3121, 3209, 3002, 3295, 3361, 3479	Lenco	3278
Televue	1040	Bush	3209, 3072, 3278	Bush	3209, 3072, 3278	Leyco	3072
Timeless	1418	CCE	3072, 3278	CCE	3072, 3278	Lloyd's	3000, 3208
Tocom	1012	CGE	3000	CGE	3000	Loewe	3037, 3081
Toshiba	1000	Calix	3037	Calix	3037	Kodak	3035, 3037
Tusa	1015	Canon	3035	Canon	3035	Korpel	3072
United Cable	1003	Capehart	3020	Capehart	3020	LXI	3037
Universal	1056, 1191	Carver	3081	Carver	3081	Lenco	3278
Viewstar	1063, 1027	Catron	3020	Catron	3020	Leyco	3072
Zenith	1000, 1054, 1525	Cimline	3072	Cimline	3072	Lloyd's	3000, 3208
Zentek	1400	Cineral	3278	Cineral	3278	Loewe	3037, 3081
<hr/>				Citizen	3037, 3278	Citizen	3037, 3278
DBS TUNER				<hr/>			
AST	2321						
Audio Ton	2364						
Avalon	2396						
Chaparral	2053, 2209						

SEG	3240
SEI	3081
STS	3042
Saba	3041, 3320, 3384
Saisho	3209, 3036, 3208
Salora	3043, 3046
Samsung	3240, 3045
Sanky	3048, 3039
Sansui	3000, 3067, 3041, 3271, 3479
Sanyo	3047, 3240, 3104, 3046
Schaub Lorenz	3000, 3104, 3041
Schneider	3081, 3000, 3072
Scott	3184, 3045, 3121, 3043, 3212
Sears	3035, 3037, 3047, 3000, 3042, 3104, 3046, 3054, 3066
Seleco	3041
Semp	3045
Sentra	3020
Sharp	3048, 3062
Shintom	3104, 3072
Shogun	3240
Siemens	3037, 3081, 3104, 3054, 3195
Silva	3037
Singer	3045, 3072
Sinudyne	3081
Solavox	3020
Sonolor	3046
Sontec	3037
Sony	3035, 3032, 3000, 3033, 3034
Sunstar	3000
Suntronic	3000
Sylvania	3035, 3081, 3000, 3043
Symphonic	3000
TMK	3240, 3036, 3208
Tashiko	3000
Tatung	3081, 3000, 3041
Teac	3000, 3041
Tec	3020
Technics	3035, 3162, 3226
Teknika	3035, 3037, 3000
Teleavia	3041
Telefunken	3041, 3187, 3320, 3384
Tenosal	3072
Tensai	3000
Thomas	3000
Thomson	3041, 3320, 3384
Thorn	3104, 3041, 3036
Toshiba	3081, 3045, 3043, 3041, 3066, 3212, 3366, 3384
Totevision	3037, 3240
Triumph	3208
Uher	3240
Unitech	3240
Universum	3037, 3081, 3240, 3000, 3195
Vector	3045
Vector Research	3038, 3040
Video Concepts	3045, 3040, 3061
Videosonic	3240
Wards	3060, 3035, 3048, 3047, 3081, 3240, 3000, 3042, 3072, 3062, 3212
White Westinghouse	3278
XR-1000	3035, 3000, 3072
Yamaha	3038
Yamishi	3072
Yokan	3072
Yoko	3240, 3020
Zenith	3039, 3000, 3033, 3034

DVD PLAYER

JVC	4558
Kenwood	4534
Magnavox	4503
Mitsubishi	4521
Onkyo	4503
Panasonic	4490
Philips	4503, 4539
Pioneer	4525
Proscan	4522
RCA	4522
Sony	4533
Technics	4490
Toshiba	4503
Yamaha	4490, 4545
Zenith	4503

LD PLAYER

Aiwa	5203
Carver	5064, 5194, 5323
Denon	5059, 5172
Disco Vision	5023
Funai	5203
Hitachi	5023
Magnavox	5194, 5217
Marantz	5064, 5194
Mitsubishi	5059
NAD	5059
Panasonic	5204
Philips	5064, 5194
Pioneer	5059, 5023
Quasar	5204
Realistic	5203
Salora	5064
Samsung	5323
Sega	5023
Sony	5193, 5201
Technics	5204
Telefunken	5059
Theta Digital	5194
Yamaha	5217

CD PLAYER

ADC	6018
Acoustic Research	6420
Adcom	6155
Aiwa	6157, 6012, 6124
Akai	6156
Arcam	6157
Audio Pro	6437
Audio Research	6157
Audio-Technica	6170
Audio Ton	6157
Audiolab	6157
Audiomeca	6157
BSR	6245
Bestar	6164
Burmester	6420
Bush	6245
California Audio Lab	6029
Carver	6157, 6179, 6437
Condor	6164
Crown	6122
Cyrus	6157
DAK	6245
DKK	6000
Denon	6003, 6034
Elektra	6393, 6437
Emerson	6305, 6155, 6164
Fisher	6179, 6048, 6088, 6342
Garrard	6420, 6393, 6245, 6280, 6425
Genexxa	6032, 6305, 6164, 6426

Goodmans	6305, 6245, 6280
Grundig	6157
Harman/Kardon	6426
Hitachi	6032, 6155
JVC	6072
Kenwood	6028, 6037, 6190, 6048
Kodak	6287
Krell	6157
Kyocera	6018
LXI	6305
Linn	6157
Luxman	6093
MCS	6029, 6043
MTC	6420
Magnavox	6157, 6305
Marantz	6029, 6157, 6180
Matsui	6157
McIntosh	6287
Memorex	6032, 6305, 6155, 6164, 6180
Meridian	6157
Micromega	6157
Mission	6157
Mitsubishi	6156
NAD	6000
NEC	6043
NSM	6157
Nagaoka	6018
Naim	6157
Nakamichi	6147
Nikko	6164, 6170
Onkyo	6101
Optimus	6000, 6032, 6179, 6305, 6037, 6420, 6048, 6145, 6468, 6087, 6280, 6342, 6426, 6437

Panasonic	6029, 6303
Parasound	6420
Philips	6157, 6287
Pioneer	6032, 6305, 6468, 6244
Poppy	6164
Proton	6157
QED	6157
Quad	6157
Quasar	6029
RCA	6179, 6305, 6053, 6155
Realistic	6179, 6420, 6155, 6164, 6180
Revox	6157
Roadstar	6461
Rotel	6157, 6420
Royal	6420
SAE	6157
STS	6018
Sansui	6157, 6305, 6202
Sanyo	6179, 6048, 6087, 6342
Scott	6305, 6155, 6164
Sears	6305
Sharp	6037, 6180, 6261
Sherwood	6114, 6180, 6426
Shure	6043
Sony	6000, 6185
Soundesign	6145, 6425
Tascam	6420
Teac	6420, 6393, 6180
Technics	6029, 6303
Universum	6157, 6437
Victor	6072
Wards	6157, 6053
Yamaha	6036, 6187, 6261, 6082, 6712
Yorx	6461

MD RECORDER

Kenwood	7826
Sony	7490
Yamaha	7888, 7490

TAPE DECK

ADC	8171
Aiwa	8029, 8197
Akai	8283
Arcam	8076
Carver	8029
Denon	8076
Fisher	8074
Garrard	8308, 8309, 8375
GoldStar	8375
Grundig	8029, 8375
JVC	8244, 8274, 8303, 8304, 8310
Kenwood	8071, 8092, 8233, 8234
Kyocera	8171
Magnavox	8029
Marantz	8029, 8009
Memorex	8099
Mitsubishi	8283
Onkyo	8136, 8282
Optimus	8027, 8220, 8337
Panasonic	8229
Philips	8029
Phonotrend	8337
Pioneer	8027, 8220, 8099
Revox	8029, 8190
Sansui	8029, 8009
Sanyo	8074
Sharp	8231
Sherwood	8337
Sonic	8375
Sony	8243, 8170, 8291
Teac	8280, 8289, 8308, 8309
Technics	8229
Universum	8375
Victor	8274
Wards	8027
Yamaha	8097, 8094, 8478, 8524



YAMAHA ELECTRONICS CORPORATION, USA 6660 ORANGETHORPE AVE., BUENA PARK, CALIF. 90620, U.S.A.
YAMAHA CANADA MUSIC LTD. 135 MILNER AVE., SCARBOROUGH, ONTARIO M1S 3R1, CANADA
YAMAHA ELECTRONIK EUROPA G.m.b.H. SIEMENSSTR. 22-34, 25462 RELLINGEN BEI HAMBURG, F.R. OF GERMANY
YAMAHA ELECTRONIQUE FRANCE S.A. RUE AMBROISE CROIZAT BP70 CROISSY-BEAUBOURG 77312 MARNE-LA-VALLEE CEDEX02, FRANCE
YAMAHA ELECTRONICS (UK) LTD. YAMAHA HOUSE, 200 RICKMANSWORTH ROAD WATFORD, HERTS WD1 7JS, ENGLAND
YAMAHA SCANDINAVIA A.B. J A WETTERGRENS GATA 1, BOX 30053, 400 43 VÄSTRA FRÖLUNDA, SWEDEN
YAMAHA MUSIC AUSTRALIA PTY, LTD. 17-33 MARKET ST., SOUTH MELBOURNE, 3205 VIC., AUSTRALIA

YAMAHA CORPORATION
Printed in Malaysia ID V403280

Quick Reference Card

AMP/TUN

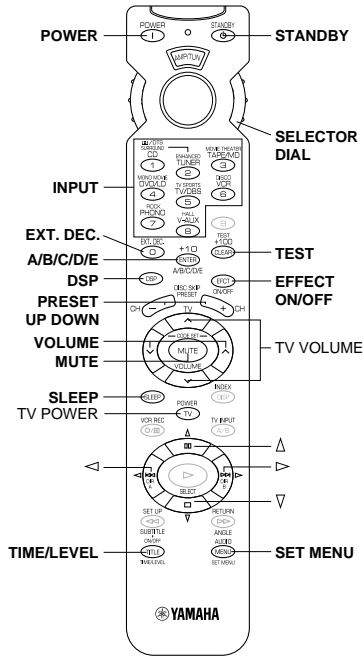

TAPE/MD

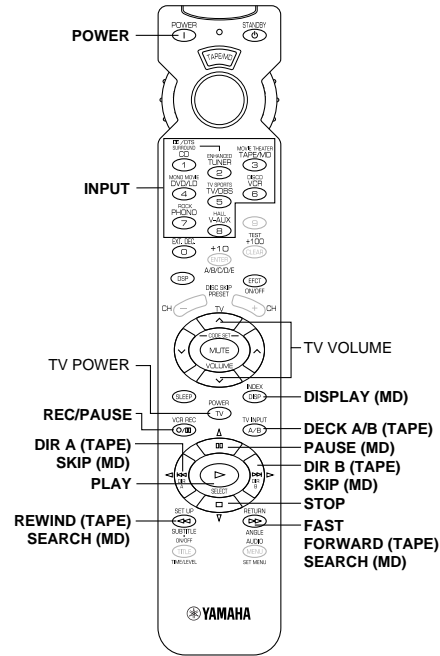

CD

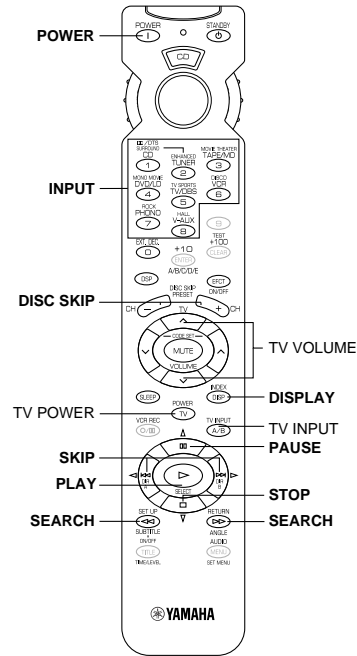

DVD/LD

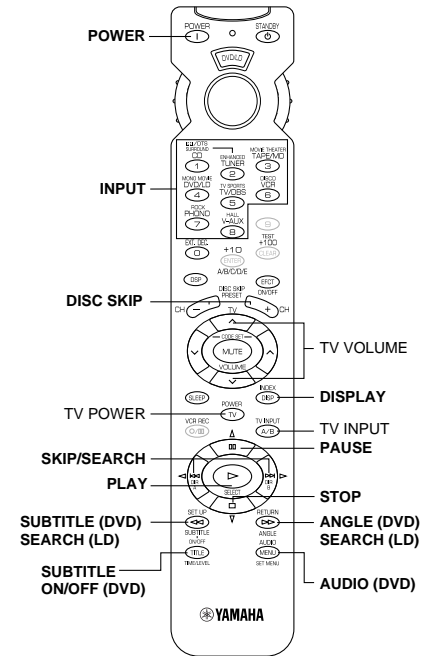

DSP

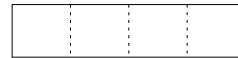
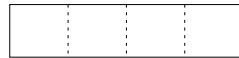
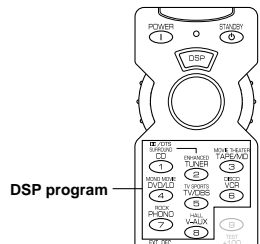

Quick Reference Card

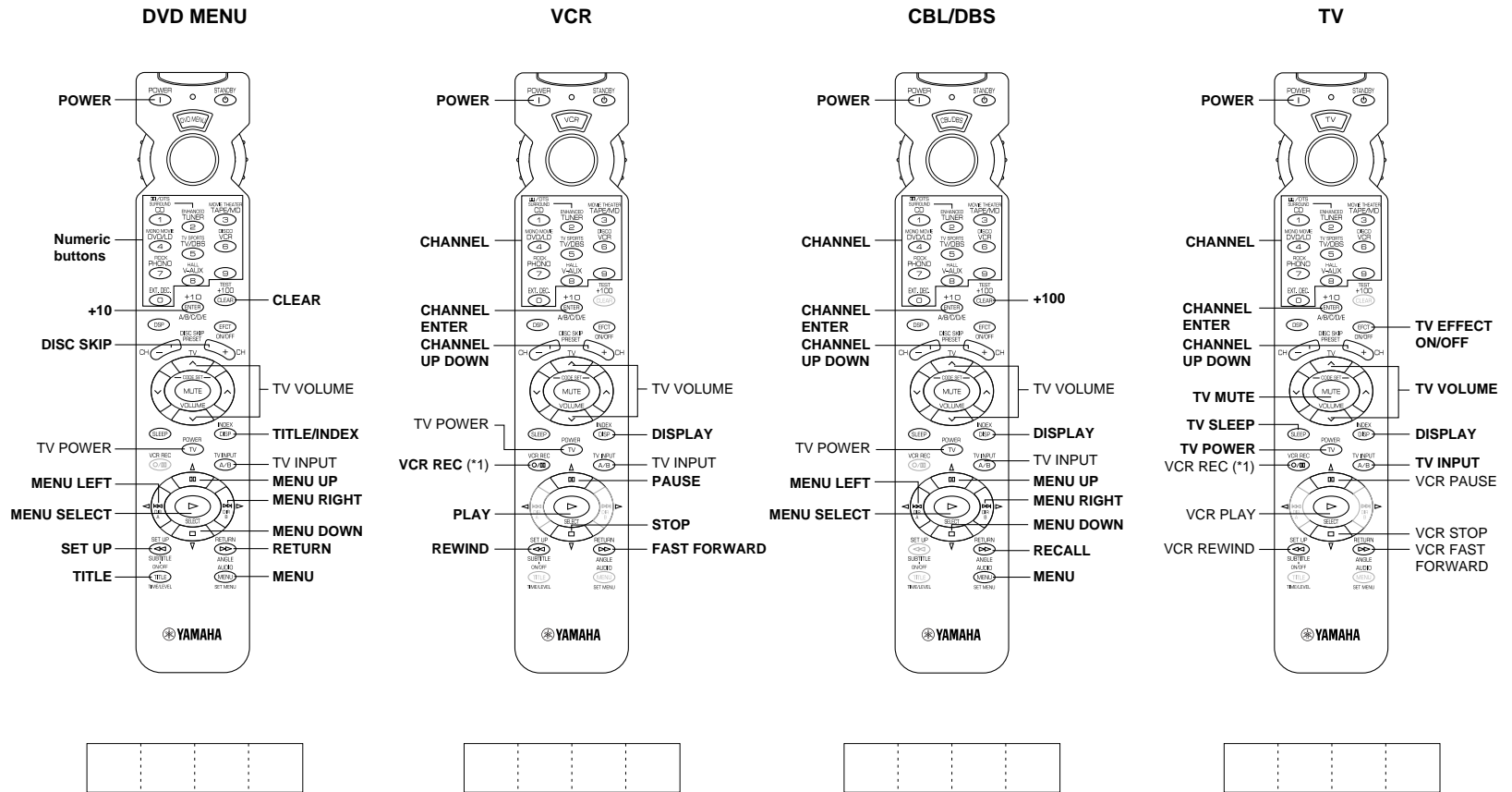

*1: Press this button twice to start recording.
 Appuyer deux fois sur cette touche pour démarrer l'enregistrement.
 Diese Taste zweimal drücken, um die Aufnahme zu starten.
 Tryck två gånger på denna knapp för att starta inspelningen.

Premere due volte questo tasto per iniziare la registrazione.
 Presione dos veces este botón para empezar a grabar.
 Druk tweemaal op deze toets om met opnemen te beginnen.
 按两次该按钮即可开始录像。