



# YAMAHA PORTATONE PSR-8000

**OWNER'S MANUAL**

# SPECIAL MESSAGE SECTION

**PRODUCT SAFETY MARKINGS:** Yamaha electronic products may have either labels similar to the graphics shown below or molded/stamped facsimiles of these graphics on the enclosure. The explanation of these graphics appears on this page. Please observe all cautions indicated on this page and those indicated in the safety instruction section.

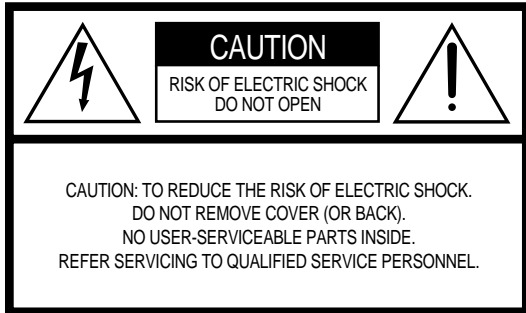

The exclamation point within the equilateral triangle is intended to alert the user to the presence of important operating and maintenance (servicing) instructions in the literature accompanying the product.

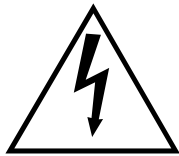

The lightning flash with arrowhead symbol, within the equilateral triangle, is intended to alert the user to the presence of uninsulated “dangerous voltage” within the product’s enclosure that may be of sufficient magnitude to constitute a risk of electrical shock.

**IMPORTANT NOTICE:** All Yamaha electronic products are tested and approved by an independent safety testing laboratory in order that you may be sure that when it is properly installed and used in its normal and customary manner, all foreseeable risks have been eliminated. **DO NOT** modify this unit or commission others to do so unless specifically authorized by Yamaha. Product performance and/or safety standards may be diminished. Claims filed under the expressed warranty may be denied if the unit is/has been modified. Implied warranties may also be affected.

**SPECIFICATIONS SUBJECT TO CHANGE:** The information contained in this manual is believed to be correct at the time of printing. However, Yamaha reserves the right to change or modify any of the specifications without notice or obligation to update existing units.

**ENVIRONMENTAL ISSUES:** Yamaha strives to produce products that are both user safe and environmentally friendly. We sincerely believe that our products and the production methods used to produce them, meet these goals. In keeping with both the letter and the spirit of the law, we want you to be aware of the following:

**Battery Notice:** This product MAY contain a small non-rechargeable battery which (if applicable) is soldered in place. The average life span of this type of battery is approximately five years. When replacement becomes necessary, contact a qualified service representative to perform the replacement.

**Warning:** Do not attempt to recharge, disassemble, or incinerate this type of battery. Keep all batteries away from children. Dispose of used batteries promptly and as regulated by applicable laws. Note: In some areas, the servicer is required by law to return the defective parts. However, you do have the option of having the servicer dispose of these parts for you.

**Disposal Notice:** Should this product become damaged beyond repair, or for some reason its useful life is considered to be at an end, please observe all local, state, and federal regulations that relate to the disposal of products that contain lead, batteries, plastics, etc.

**NOTICE:** Service charges incurred due to lack of knowledge relating to how a function or effect works (when the unit is operating as designed) are not covered by the manufacturer’s warranty, and are therefore the owners responsibility. Please study this manual carefully and consult your dealer before requesting service.

**NAME PLATE LOCATION:** The graphic below indicates the location of the name plate. The model number, serial number, power requirements, etc., are located on this plate. You should record the model number, serial number, and the date of purchase in the spaces provided below and retain this manual as a permanent record of your purchase.

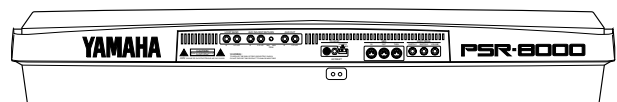

**Model** \_\_\_\_\_

**Serial No.** \_\_\_\_\_

**Purchase Date** \_\_\_\_\_

# IMPORTANT SAFETY INSTRUCTIONS

## INFORMATION RELATING TO PERSONAL INJURY, ELECTRICAL SHOCK, AND FIRE HAZARD POSSIBILITIES HAS BEEN INCLUDED IN THIS LIST.

**WARNING-** When using any electrical or electronic product, basic precautions should always be followed. These precautions include, but are not limited to, the following:

- 1.** Read all Safety Instructions, Installation Instructions, Special Message Section items, and any Assembly Instructions found in this manual **BEFORE** making any connections, including connection to the main supply.
- 2.** Main Power Supply Verification: Yamaha products are manufactured specifically for the supply voltage in the area where they are to be sold. If you should move, or if any doubt exists about the supply voltage in your area, please contact your dealer for supply voltage verification and (if applicable) instructions. The required supply voltage is printed on the name plate. For name plate location, please refer to the graphic found in the Special Message Section of this manual.
- 3.** This product may be equipped with a polarized plug (one blade wider than the other). If you are unable to insert the plug into the outlet, turn the plug over and try again. If the problem persists, contact an electrician to have the obsolete outlet replaced. Do **NOT** defeat the safety purpose of the plug.
- 4.** Some electronic products utilize external power supplies or adapters. Do **NOT** connect this type of product to any power supply or adapter other than one described in the owners manual, on the name plate, or specifically recommended by Yamaha.
- 5.** **WARNING:** Do not place this product or any other objects on the power cord or place it in a position where anyone could walk on, trip over, or roll anything over power or connecting cords of any kind. The use of an extension cord is not recommended! If you must use an extension cord, the minimum wire size for a 25' cord (or less) is 18 AWG. **NOTE:** The smaller the AWG number, the larger the current handling capacity. For longer extension cords, consult a local electrician.
- 6.** Ventilation: Electronic products, unless specifically designed for enclosed installations, should be placed in locations that do not interfere with proper ventilation. If instructions for enclosed installations are not provided, it must be assumed that unobstructed ventilation is required.
- 7.** Temperature considerations: Electronic products should be installed in locations that do not significantly contribute to their operating temperature. Placement of this product close to heat sources such as; radiators, heat registers and other devices that produce heat should be avoided.
- 8.** This product was **NOT** designed for use in wet/damp locations and should not be used near water or exposed to rain. Examples of wet/damp locations are; near a swimming pool, spa, tub, sink, or wet basement.
- 9.** This product should be used only with the components supplied or; a cart, rack, or stand that is recommended by the manufacturer. If a cart, rack, or stand is used, please observe all safety markings and instructions that accompany the accessory product.
- 10.** The power supply cord (plug) should be disconnected from the outlet when electronic products are to be left unused for extended periods of time. Cords should also be disconnected when there is a high probability of lightening and/or electrical storm activity.
- 11.** Care should be taken that objects do not fall and liquids are not spilled into the enclosure through any openings that may exist.
- 12.** Electrical/electronic products should be serviced by a qualified service person when:
  - a. The power supply cord has been damaged; or
  - b. Objects have fallen, been inserted, or liquids have been spilled into the enclosure through openings; or
  - c. The product has been exposed to rain; or
  - d. The product does not operate, exhibits a marked change in performance; or
  - e. The product has been dropped, or the enclosure of the product has been damaged.
- 13.** Do not attempt to service this product beyond that described in the user-maintenance instructions. All other servicing should be referred to qualified service personnel.
- 14.** This product, either alone or in combination with an amplifier and headphones or speaker/s, may be capable of producing sound levels that could cause permanent hearing loss. **DO NOT** operate for a long period of time at a high volume level or at a level that is uncomfortable. If you experience any hearing loss or ringing in the ears, you should consult an audiologist. **IMPORTANT:** The louder the sound, the shorter the time period before damage occurs.
- 15.** Some Yamaha products may have benches and/or accessory mounting fixtures that are either supplied as a part of the product or as optional accessories. Some of these items are designed to be dealer assembled or installed. Please make sure that benches are stable and any optional fixtures (where applicable) are well secured **BEFORE** using. Benches supplied by Yamaha are designed for seating only. No other uses are recommended.

## PLEASE KEEP THIS MANUAL

# PRECAUTIONS

## PLEASE READ CAREFULLY BEFORE PROCEEDING

\* Please keep these precautions in a safe place for future reference.



### WARNING

Always follow the basic precautions listed below to avoid the possibility of serious injury or even death from electrical shock, short-circuiting, damages, fire or other hazards. These precautions include, but are not limited to, the following:

- Do not open the instrument or attempt to disassemble the internal parts or modify them in any way. The instrument contains no user-serviceable parts. If it should appear to be malfunctioning, discontinue use immediately and have it inspected by qualified Yamaha service personnel.
- Do not expose the instrument to rain, use it near water or in damp or wet conditions, or place containers on it containing liquids which might spill into any openings.
- If the power cord or plug becomes frayed or damaged, or if there is a sudden loss of sound during use of the instrument, or if any unusual smells

or smoke should appear to be caused by it, immediately turn off the power switch, disconnect the electric plug from the outlet, and have the instrument inspected by qualified Yamaha service personnel.

- Only use the voltage specified as correct for the instrument. The required voltage is printed on the name plate of the instrument.
- Before cleaning the instrument, always remove the electric plug from the outlet. Never insert or remove an electric plug with wet hands.
- Check the electric plug periodically and remove any dirt or dust which may have accumulated on it.



### CAUTION

Always follow the basic precautions listed below to avoid the possibility of physical injury to you or others, or damage to the instrument or other property. These precautions include, but are not limited to, the following:

- Do not place the power cord near heat sources such as heaters or radiators, and do not excessively bend or otherwise damage the cord, place heavy objects on it, or place it in a position where anyone could walk on, trip over, or roll anything over it.
- When removing the electric plug from the instrument or an outlet, always hold the plug itself and not the cord. Pulling by the cord can damage it.
- Do not connect the instrument to an electrical outlet using a multiple-connector. Doing so can result in lower sound quality, or possibly cause overheating in the outlet.
- Remove the electric plug from the outlet when the instrument is not to be used for a long time, or during electrical storms.
- Before connecting the instrument to other electronic components, turn off the power for all components. Before turning the power on or off for all components, set all volume levels to minimum.
- Do not expose the instrument to excessive dust or vibrations, or extreme cold or heat (such as in direct sunlight, near a heater, or in a car during the day) to prevent the possibility of panel disfiguration or damage to the internal components.
- Do not use the instrument near other electrical products such as televisions, radios, or speakers, since this might cause interference which can affect proper operation of the other products.
- Do not place the instrument in an unstable position where it might accidentally fall over.
- Before moving the instrument, remove all connected cables.
- When cleaning the instrument, use a soft, dry cloth. Do not use paint thinners, solvents, cleaning fluids, or chemical-impregnated wiping cloths. Also, do not place vinyl or plastic objects on the instrument, since this might discolor the panel or keyboard.
- Do not rest your weight on, or place heavy objects on the instrument, and do not use excessive force on the buttons, switches or connectors.
- Use only the stand specified for the instrument. When attaching the stand or rack, use the provided screws only. Failure to do so could cause damage to the internal components or result in the instrument falling over.
- Do not place objects in front of the instrument's air vents on the top and rear panels, since this may prevent adequate ventilation of the internal components, and possibly result in the instrument overheating. Also, be careful to place the instrument on a flat, level surface to prevent blockage of the air vents on the bottom panel.
- Do not operate the instrument for a long period of time at a high or uncomfortable volume level, since this can cause permanent hearing loss. If you experience any hearing loss or ringing in the ears, consult a physician.

alkaline batteries.

1. Before changing the battery be sure to save any important data to disk by using the SAVE TO DISK function described on page 141.
2. Turn the PSR-8000 power OFF and unplug the power cord from both the AC wall socket and the instrument's rear panel. Turn the instrument upside down and rest it on a blanket or other soft surface.
3. **Open Battery Compartment Cover**  
Open the battery compartment cover — located on the instrument's bottom panel — by pressing on the two latches on the cover and pulling outward, as shown in the illustration.
4. **Remove the old batteries (if installed).**  
Remove the old batteries and wait at least one minute to ensure that all data is fully cleared.
5. **Insert Batteries**  
Insert the four batteries, being careful to follow the polarity markings on the bottom panel.
6. **Replace Cover**  
Replace the compartment cover, making sure that it locks firmly in place.

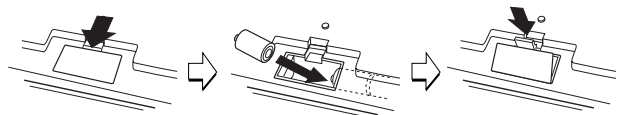

- Always make sure all batteries are inserted in conformity with the +/- polarity markings. Failure to do so might result in overheating, fire, or battery fluid leakage.
- Always replace all batteries at the same time. Do not use new batteries together with old ones. Also, do not mix battery types, such as alkaline batteries with manganese batteries, or batteries from different makers, or different types of batteries from the same maker, since this can cause overheating, fire, or battery fluid leakage.
- Do not dispose of batteries in fire.
- Do not attempt to recharge batteries that are not intended to be charged.
- If the instrument is not to be in use for a long time, remove the batteries from it (after saving any important data to disk), in order to prevent possible fluid leakage from the battery.
- Keep batteries away from children.

### SAVING USER DATA

- Always save data to a floppy disk frequently, in order to help prevent the loss of important data due to a malfunction or user operating error.

Yamaha cannot be held responsible for damage caused by improper use or modifications to the instrument, or data that is lost or destroyed.

Always turn the power off when the instrument is not in use.  
Make sure to discard used batteries according to local regulations.

### REPLACING THE BACKUP BATTERY

The PSR-8000 requires four 1.5 V C size (LR14) batteries for memory backup power. If no backup batteries are installed, the memory contents will be lost when the instrument is unplugged from the AC mains supply. Please use

## Handling the Floppy Disk Drive(FDD) and Floppy Disk

### Precautions

- Be sure to handle floppy disks and treat the disk drive with care. Follow the important precautions below.

### Compatible Disk Type

- 3.5" 2DD and 2HD type floppy disks can be used.

### ■ Inserting/Ejecting Floppy Disks

#### To insert a floppy disk into the disk drive:

- Hold the disk so that the label of the disk is facing upward and the sliding shutter is facing forward, towards the disk slot. Carefully insert the disk into the slot, slowly pushing it all the way in until it clicks into place and the eject button pops out.

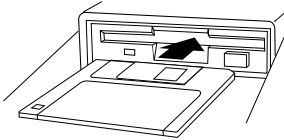

This lamp is always on while the power is on.

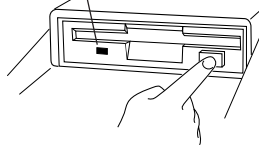

#### To eject a floppy disk:

- Before ejecting a floppy disk make sure that the floppy disk drive is not in operation (the DISK IN USE indicator should be off, except when the internal hard disk is being accessed). Press the eject button slowly as far as it will go; the disk will automatically pop out. When the disk is fully ejected, carefully remove it by hand.
- Never attempt to remove the disk or turn the power off during recording, reading and playing back. Doing so can damage the disk and possibly the disk drive.
- If the eject button is pressed too quickly, or if it is not pressed in as far as it will go, the disk may not eject properly. The eject button may become stuck in a half-pressed position with the disk extending from the drive slot by only a few millimeters. If this happens, do not attempt to pull out the partially ejected disk, since using force in this situation can damage the disk drive mechanism or the floppy disk. To remove a partially ejected disk, try pressing the eject button once again, or push the disk back into the slot and then repeat the eject procedure.
- Be sure to remove the floppy disk from the disk drive before turning off the power. A floppy disk left in the drive for extended periods can easily pick up dust and dirt that can cause data read and write errors.

### Cleaning the Disk Drive Read/Write Head

- Clean the read/write head regularly. This instrument employs a precision magnetic read/write head which, after an extended period of use,

will pick up a layer of magnetic particles from the disks used that will eventually cause read and write errors.

- To maintain the disk drive in optimum working order Yamaha recommends that you use a commercially-available dry-type head cleaning disk to clean the head about once a month. Ask your Yamaha dealer about the availability of proper head-cleaning disks.

Never insert anything but floppy disks into the disk drive. Other objects may cause damage to the disk drive or floppy disks.

### ■ About the Floppy Disks

#### To handle floppy disks with care:

- Do not place heavy objects on a disk or bend or apply pressure to the disk in any way. Always keep floppy disks in their protective cases when they are not in use.
- Do not expose the disk to direct sunlight, extremely high or low temperatures, or excessive humidity, dust or liquids.
- Do not open the sliding shutter and touch the exposed surface of the floppy disk inside.
- Do not expose the disk to magnetic fields, such as those produced by televisions, speakers, motors, etc., since magnetic fields can partially or completely erase data on the disk, rendering it unreadable.
- Never use a floppy disk with a deformed shutter or housing.
- Do not attach anything other than the provided labels to a floppy disk. Also make sure that labels are attached in the proper location.

#### To protect your data (Write-protect Tab):

- To prevent accidental erasure of important data, slide the disk's write-protect tab to the "protect" position (tab open).

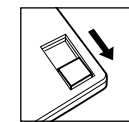
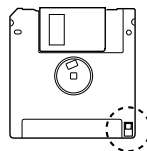

Write protected

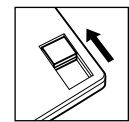

Write enabled

#### Data backup

- For maximum data security Yamaha recommends that you keep two copies of important data on separate floppy disks. This gives you a backup if one disk is lost or damaged. To make a backup disk use the COPY FILE/FD function on page 143.

YAMAHA is not responsible for damage caused by improper handling or operation.  
YAMAHA provides no guarantee against disk damage.

## Handling and Installation of Options

### ⚠ WARNING

- Before beginning installation, switch off the power to the PSR-8000 and connected peripherals, and unplug them from the power outlet. Then remove all cables connecting the PSR-8000 to other devices. (Leaving the power cord connected while working can result in electric shock. Leaving other cables connected can interfere with work.)
- Do not disassemble, modify, or apply excessive force to board areas and connectors on hard disk, and SIMMs. Bending or tampering with boards and connectors may lead to electric shock, fire, or equipment failures.

### ⚠ CAUTION

- Before handling the internal hard disk or SIMMs, you should briefly touch the metal surface to which the hard-disk or SIMM cover is attached (or

other such metallic area — be careful of any sharp edges) with your bare hand so as to drain off any static charge from your body. Note that even a slight amount of electrostatic discharge may cause damage to these components.

- It is recommended that you wear gloves to protect your hands from metallic projections on the PSR-8000 hard disk, SMMs, and other components. Touching leads or connectors with bare hands may cause finger cuts, and may also result in poor electrical contact or electrostatic damage.
- Take care to avoid dropping screws into the PSR-8000 unit. If a screw does fall in, be sure to remove it before replacing the cover and powering up the unit. Starting the unit with a loose screw inside may lead to improper operation or equipment failure. (If you are unable to retrieve a dropped screw, consult your Yamaha dealer for advice.)

\* If SIMM memory, or hard disk fails to work properly, consult the item's dealer or manufacturer for advice.

\* Yamaha will not be held responsible for any damage or injury resulting from improper installation.

# Congratulations!

*You are the proud owner of an extraordinary electronic keyboard. The Yamaha PSR-8000 PortaTone combines the most advanced tone generation technology with state-of-the-art digital electronics and features to give you stunning sound quality with maximum musical versatility. The advanced Auto Accompaniment, Vocal Harmony, and Sampler features, in particular, are brilliant examples of how Yamaha technology can significantly expand your musical horizons. A large-size graphic display and easy-to-use interface also greatly enhance the operability of this advanced instrument.*

*In order to make the most of your PortaTone's features and vast performance potential, we urge you to read the manuals thoroughly while trying out the various features described. Keep the manuals in a safe place for later reference.*

## Packing List

Your PSR-8000 includes the following items:

- PSR-8000 PortaTone x 1
- AC Power Cord x 1
- AC Plug Adaptor x 1 (in applicable areas only)
- Music Stand x 1
- Audio CD x 1 (includes sound sources for sampling: page 88)
- Floppy Disk x 1 (includes accompaniment style files: page 28)
- Owner's Manual

• The illustrations and LCD screens as shown in this owner's manual are for instructional purposes only, and may appear somewhat different from those on your instrument.

• Unauthorized copying of copyrighted software for purposes other than the purchaser's personal use is prohibited.

• The Vocal Harmony feature included in this product is manufactured under license from IVL Technologies Ltd., U.S. Patent numbers 5231671, 5301259, and 5428708.

### ● Trademarks:

- Apple and Macintosh are trademarks of Apple Computer, Inc.
- IBM-PC/AT is a trademark of International Business Machines Corporation.
- Windows is the registered trademark of Microsoft® Corporation.
- All other trademarks are the property of their respective holders.

## The Panel Logos

The logos printed on the PSR-8000 panel indicate standards/formats it supports and special features it includes.



### GM System Level 1

"GM System Level 1" is an addition to the MIDI standard which guarantees that any data conforming to the standard will play accurately on any GM-compatible tone generator or synthesizer from any manufacturer.



### XG

XG is a new Yamaha MIDI specification which significantly expands and improves on the "GM System Level 1" standard with greater voice handling capacity, expressive control, and effect capability while retaining full compatibility with GM. By using the PSR-8000's XG voices, it is possible to record XG-compatible song files.



### XF

The Yamaha XF format enhances the SMF (Standard MIDI File) standard with greater functionality and open-ended expandability for the future. The PSR-8000 is capable of displaying lyrics when an XF file containing lyric data is played.



### NOTE

- SMF (Standard MIDI File) is the most common format used for MIDI sequence files. The PSR-8000 is compatible with SMF Formats 0 and 1, and records "song" data using SMF Format 0.

# Main Features

The PSR-8000 is a sophisticated electronic keyboard which offers a comprehensive range of features for extensive musical versatility and expressive control: a touch-sensitive 61-key keyboard, an outstanding range of voices (including XG voices), top quality auto-accompaniment with an extensive range of styles, song recording and playback capability, registration memory, and a built-in floppy disk for convenient data storage and retrieval, and more.

The following features, in particular, give the PSR-8000 extraordinary musical production and performance power.

- High-quality sampling capability — with expandable wave memory — lets you sample and edit sounds via microphone or from line sources, and then use the sampled waveforms in original voices.
- Unique Vocal Harmony feature incorporates advanced voice-processing technology to automatically produce vocal harmony based on a lead vocal, making a single singer sound like a vocal group.
- An advanced effect system incorporating 8 separate DSPs (Digital Signal Processors) and 5-band master equalization adds depth, ambience, and animation to your sound.
- Comprehensive Mixing Console displays provide professional sound control and production capability.
- Large multi-function LCD display panel with display-based buttons and dials, plus comprehensive display prompts and messages, makes operation easy and intuitive.
- Create original voices using the Voice Creator feature for a totally original sound.
- Style Creator feature lets you create “groove style” variations on existing styles, or create entirely new styles that are a perfect match for your performing requirements.
- One Touch Setting feature automatically selects appropriate voice, effect, and other settings for the selected accompaniment style — all you have to do is select a style, press the ONE TOUCH SETTING button and play.
- Multi Pads record and play short rhythmic and melodic sequences that can be used to add impact and variety to your performances.
- Voice/Style List Customize feature lets you rearrange the list contents for fast, efficient access in performance situations.
- Unique “Talk” function instantly makes the settings you need for mid-performance announcements and interludes.
- Loop Send and Return jacks allow extra system flexibility: connect external signal-processing equipment for enhanced effect capability, or feed a mixer for improved sound and on-stage monitoring quality.
- Optional internal hard disk provides high-volume, high-speed data storage and retrieval.
- A selection of MIDI Templates eliminates tedious setup procedures by providing instantly selectable MIDI setups for a range of situations.
- To Host interface plus a range of MIDI functions for expanded musical performance (General MIDI System Level 1 and Yamaha XG/XF compatible).



## DOC

The DOC voice allocation format provides data playback compatibility with a wide range of Yamaha instruments and MIDI devices, including the Clavinova series.



## Style File Format

The Style File Format — SFF — is Yamaha's original style file format which uses a unique conversion system to provide high-quality automatic accompaniment based on a wide range of chord types. The PSR-8000 uses the SFF internally, reads optional SFF style disks, and creates SFF styles using the STYLE CREATOR feature.



## Vocal Harmony

Vocal Harmony employs state-of-the-art digital signal processing technology to automatically add appropriate vocal harmony to a lead vocal line sung by the user. Vocal Harmony can even change the character and gender of the lead voice as well as the added voices to produce a wide range of vocal harmony effects.

# Contents

<b>Panel Controls</b> .....	10
<b>Connections &amp; Music Stand</b> .....	12
<b>The Demonstration</b> .....	17
<b>The PSR-8000 Display &amp; Display-based Controls</b> .....	19
■ The MIXING CONSOLE Buttons .....	19
■ The [EXIT] Button .....	20
■ The [DIRECT ACCESS] Button .....	20
■ The [LCD CONTRAST] Control .....	20
■ The 5-language Help Function .....	20
■ Display Messages .....	21
■ Name Entry .....	21
<b>Playing the PSR-8000</b> .....	22
■ Before You Begin .....	22
<b>The PSR-8000 Parts &amp; Voices</b> .....	22
■ Part Poly/Mono Modes & Mono Note Priority .....	22
■ The XG Voices .....	23
■ The Organ Flute Voice .....	23
■ Keyboard Percussion and Special Effects .....	24
Procedure: <b>Part Selection and Voice Assignment</b> .....	24
<b>Voice Effects</b> .....	26
<b>Other Play Mode Functions</b> .....	26
■ Master Transpose .....	26
■ Octave Change .....	27
■ Left Hold .....	27
■ Pitch Bend & Modulation Wheels .....	27
<b>Using the Accompaniment Section</b> .....	28
Procedure: <b>Auto Accompaniment</b> .....	28
■ Auto Accompaniment Fingering Modes .....	30
■ Auto Accompaniment Start Modes .....	33
■ The MAIN A and MAIN B Sections and Fill-ins .....	34
■ Tempo Control .....	35
■ Fade-ins and Fade-outs .....	35
■ Synchronized Stop .....	35
■ Accompaniment Volume .....	36
■ Accompaniment Part Switching .....	36
■ Virtual Arranger .....	36
■ Harmony/Echo .....	37
■ One Touch Setting .....	38
<b>The Mixing Console</b> .....	39
<b>Mixing Console Parameters</b> .....	39
<b>VOLUME/PAN/EQ</b> .....	40
■ VOLUME .....	40
■ PANPOT .....	40
■ EQ LOW .....	40
■ EQ HIGH .....	40
■ HPF1 .....	40
■ HPF2 .....	40
<b>FILTER</b> .....	41
■ HARMONIC CONTENT .....	41
■ BRIGHTNESS .....	41
<b>EFFECT DEPTH</b> .....	41
■ REVERB (DSP1) .....	41
■ CHORUS (DSP2) .....	41
■ DSP3 .....	42
■ DSP4-7 .....	42
<b>EFFECT TYPE</b> .....	42
■ Type Page .....	42
● EFFECT BLOCK & TYPE .....	42
● TYPE LIST .....	42
■ Parameter Page .....	42
● BLOCK .....	42
● TYPE .....	42
● PARAMETER .....	43
● VALUE .....	43
● LEVEL .....	43
● USER SET .....	43
<b>TUNING</b> .....	44
■ TRANSPOSE .....	44
■ TUNING .....	44
■ OCTAVE .....	44
■ PITCH BEND RANGE .....	44
■ PORTAMENTO TIME .....	44
<b>MASTER EQ</b> .....	45
■ EQ1 ... EQ5 .....	45
■ Q & FREQ .....	45
■ TOTAL GAIN ADJUST .....	45
■ STORE .....	45
<b>Registration Memory</b> .....	46
<b>Registering the Panel Settings</b> .....	46
<b>Recalling the Registered Panel Settings</b> .....	47
<b>The Freeze Function</b> .....	47
<b>Organ Flute Voice Editing</b> .....	48
■ ORGAN TYPE .....	48
■ ROTARY SP SPEED .....	48
■ VIBRATO ON/OFF .....	48
■ VIBRATO DEPTH .....	48
■ FOOTAGE .....	48
■ VOLUME & ATTACK .....	49
■ EFFECT & EQ SETTINGS .....	49
<b>Custom Voice Creator</b> .....	51
Procedure: <b>Engaging the Easy/Full Edit Mode</b> .....	51
<b>The Easy Edit Parameters</b> .....	52
<b>EDIT</b> .....	52
■ FILTER .....	52
■ EG .....	52
■ VIBRATO .....	53
■ VOLUME .....	53
<b>STORE/CLEAR</b> .....	53
■ NAME .....	53
■ STORE .....	53
■ CLEAR CUSTOM VOICE .....	54
<b>The Full Edit Parameters</b> .....	54
■ ELEMENT SELECTION (not available for the Drum Kits) .....	54
<b>VOICE</b> .....	55
■ MASTER VOLUME .....	55
■ INITIAL TOUCH CURVE .....	55
■ SCALE CURVE .....	55
■ MODULATION .....	55
■ AFTER TOUCH .....	55
<b>E1:WAVEFORM</b> .....	56
■ WAVEFORM (INSTRUMENT for the Drum Kits) .....	56
■ COARSE TUNE/FINE TUNE .....	56
■ VOLUME .....	56
■ KEY ON DELAY .....	56
■ PAN .....	56
■ NOTE LIMIT (not available for the Drum Kits) .....	56
■ VELOCITY LIMIT (not available for the Drum Kits) .....	56
<b>E2:EG</b> .....	57
■ AMP RATE (Amplitude Envelope Rate) .....	57
■ AMP LEVEL (Amplitude Envelope Level) .....	57
■ PITCH RATE (Pitch Envelope Rate) .....	58
■ PITCH LEVEL .....	58
■ FILTER RATE .....	58
■ FILTER LEVEL .....	58
<b>E3:FILTER</b> .....	59
■ FILTER1 & FILTER2 .....	59
■ RESONANCE .....	59
■ TOUCH TO FILTER .....	59
<b>E4:LFO</b> .....	59
■ LFO (Low Frequency Oscillator) .....	59
■ DELAY (Delay Vibrato) .....	60
<b>VOICE SET</b> .....	60
■ REVERB, CHORUS, and DSP DEPTH .....	60
■ DSP TYPE and VARIATION .....	60
■ EQ LOW and HIGH .....	60
<b>STORE/CLEAR</b> .....	61
■ NAME .....	61
■ STORE .....	61
■ CLEAR CUSTOM VOICE .....	61
<b>The Custom Style Creator</b> .....	62
Procedure: <b>Custom Style Recording</b> .....	62
<b>CUSTOM STYLE CREATOR Parameters</b> .....	66
■ Exiting .....	66
<b>BASIC</b> .....	66
■ SECTION/PATTERN LENGTH/BEAT/TEMPO .....	66
■ PART COPY .....	67
<b>SETUP</b> .....	67
■ VOICE .....	67
■ SETUP COPY .....	68
<b>EDIT</b> .....	68
■ QUANTIZE .....	68
■ VELOCITY CHANGE .....	69
■ MEASURE COPY .....	69
■ MEASURE CLEAR .....	69
■ REMOVE CONTROL EVENT .....	69
■ REMOVE DUPLICATE NOTES .....	70
<b>STORE/CLEAR</b> .....	70
■ NAME .....	70
■ STORE .....	70
■ CLEAR CUSTOM STYLE .....	70
<b>PARAMETER EDIT</b> .....	71
■ PART/SOURCE ROOT/SOURCE CHORD .....	71
■ NTR/NTT .....	71
■ HIGH KEY/NOTE LIMIT .....	72
■ RTR .....	72



<b>Custom Style Recording via an External Sequence Recorder</b> .....	73
■ Connections .....	73
■ Creating the Data .....	73
■ Saving and Loading the Sequence Data .....	75
■ Refining the Style .....	75

## **The Groove Style Creator** .....

Procedure: **Creating a Groove Style** ..... 76

<b>GROOVE STYLE CREATOR</b>	
<b>Parameters</b> .....	77
■ Exiting .....	77
<b>SETUP</b> .....	78
■ PART ON/OFF/TEMPO .....	78
■ VOICE .....	78
■ SETUP COPY .....	78
<b>GROOVE</b> .....	79
■ GROOVE .....	79
■ SETUP COPY .....	79
<b>DYNAMICS</b> .....	80
■ DYNAMICS .....	80
■ SETUP COPY .....	80
<b>STORE/CLEAR</b> .....	80
■ NAME .....	80
■ STORE .....	81
■ GROOVE STYLE CLEAR .....	81
■ STORE AS CUSTOM STYLE .....	81
■ CUSTOM STYLE CLEAR .....	81
<b>DRUM EXCHANGE</b> .....	82
■ DRUM EXCHANGE .....	82
■ SETUP COPY .....	82

## **Vocal Harmony** .....

<b>Using Vocal Harmony</b> .....	83
■ Setting Up .....	83
■ The VOCAL/SAMPLING Buttons .....	83
■ Selecting a VOCAL HARMONY Type .....	84
■ Producing the VOCAL HARMONY Effect .....	84
<b>Editing the Vocal Harmony Parameters</b> .....	84
■ The Vocal Harmony Modes .....	85

## **Sampling** .....

<b>PSR-8000 Waves &amp; Waveforms</b> .....	88
<b>Setting Up for Sampling</b> .....	89
■ Connecting the Source .....	89
■ Setting Levels .....	89
<b>Sampling &amp; File Import</b> .....	90
■ Sampling New Material .....	90
■ NAME/CLEAR .....	92
<b>Wave Edit</b> .....	93
■ EDIT .....	93
■ NAME/CLEAR/DISK .....	96
<b>Waveform Edit</b> .....	97
■ EDIT .....	97
■ NAME/CLEAR/DISK .....	98
■ STORE AS CUSTOM VOICE .....	99

## **Song Playback** .....

Procedure: <b>Song Playback</b> .....	100
Enter Next Song .....	101

<b>Pause, Fast Forward &amp; Reverse</b> .....	102
<b>Lyric Display</b> .....	102
<b>The CHORD DETECT and VOCAL HARM. Parameters</b> .....	102
■ CHORD DETECT .....	102
■ VOCAL HARM. ....	102
<b>Setting the Song Playback Order</b> ..	103
<b>MIXING CONSOLE Operation During Song Playback</b> .....	103
■ FADER .....	103
■ FULL .....	104

## **Song Recording** .....

Procedure: **Song Recording** .....

Procedure: <b>Quick Record</b> .....	106
■ THE TRACK INDICATORS .....	108
■ TRACK DELETE .....	108
■ PLAYBACK .....	108
■ EXITING .....	108

Procedure: **Chord Step Recording** .....

■ DELETING EVENTS .....	110
■ INSERTING OR DELETING MEASURES .....	110
■ SAVING THE CHORD STEP DATA .....	110

### **Quick Record Mode Edit Functions**

■ RENAME SONG .....	111
■ SONG DELETE .....	111

Procedure: **Multi Track Record** .....

■ THE TRACK INDICATORS .....	113
■ TRACK DELETE .....	114
■ PLAYBACK .....	114
■ EXITING .....	114

Procedure: **Punch-In & Replace Recording** .....

<b>Multi Track Record Mode Edit Functions</b> .....	116
■ RENAME SONG .....	116
■ QUANTIZE .....	116
■ TRACK MIX .....	117
■ NOTE SHIFT .....	117
■ SONG DELETE .....	117
<b>Multi Track Record Set Up</b> .....	118
■ VOICE .....	118
■ OTHER SET UP PARAMETERS ..	118

## **The Multi Pads** .....

**MULTI PAD Playback** .....

Procedure: **MULTI PAD Recording** .....

■ MULTI PAD NAME .....	121
■ MULTI PAD CLEAR .....	121
<b>The Repeat &amp; Chord Match Modes</b> ..	121
■ REPEAT .....	121
■ CHORD MATCH .....	121

## **The PSR-8000 "Functions"** .....

**The FUNCTION Parameters** .....

■ The [EXIT] Button .....	122
<b>F1: MASTER TUNE/SCALE</b> .....	123
■ MASTER TUNE .....	123
■ SCALE (ARABIC) .....	123
<b>F2: SPLIT POINT/FINGERING</b> .....	123
■ SPLIT POINT .....	123
■ FINGERING .....	124

<b>F3: CONTROLLER</b> .....	124
■ FOOT CONTROLLER .....	124
■ PANEL CONTROLLER .....	126
<b>F4: REGISTRATION/ONE TOUCH SETTING/VOICE SET</b> .....	127
■ REGISTRATION .....	127
■ ONE TOUCH SETTING .....	127
■ VOICE SET .....	128
<b>F5: HARMONY/ECHO</b> .....	129
<b>F6: CUSTOMIZE LIST</b> .....	129
<b>F7: TALK SETTING</b> .....	130
<b>F8: UTILITY</b> .....	131
<b>F9: MIDI</b> .....	132
■ TEMPLATE .....	132
■ SYSTEM .....	134
■ TRANSMIT .....	135
■ RECEIVE .....	136
■ PANEL CONTROL .....	138

## **Disk Operations** .....

**The DISK Parameters** .....

■ Exiting .....	140
<b>LOAD FROM DISK</b> .....	140
<b>SAVE TO DISK</b> .....	141
<b>COPY FILE/FD</b> .....	143
■ Copying Files .....	143
■ Copying Floppy Disks .....	144
<b>CHANGE SONG ORDER</b> .....	144
<b>RENAME FILE/SONG</b> .....	145
<b>DELETE FILE/SONG</b> .....	145
<b>FORMAT FD</b> .....	146
<b>EDIT DIRECTORY</b> .....	146
■ NEW DIR .....	146
■ RENAME .....	146
■ DELETE .....	146
<b>FORMAT HARD DISK</b> .....	147
<b>CHECK HARD DISK</b> .....	147

## **Troubleshooting** .....

## **Index** .....

<b>Installing Options</b> .....	152
Optional SIMM Installation .....	152
Optional Hard Disk Installation .....	156
<b>Voice List</b> .....	159
<b>Keyboard Drum Assignments</b> .....	166
<b>Style List</b> .....	168
<b>Direct Access Chart</b> .....	170
<b>Parameter Chart</b> .....	171
<b>Effect Signal Flow Chart</b> .....	176
<b>MIDI Data Format</b> .....	177
<b>MIDI Implementation Chart</b> .....	196
<b>Audio Sampling Library CD</b>	
<b>Contents</b> .....	200
<b>Specifications</b> .....	203

# Panel Controls

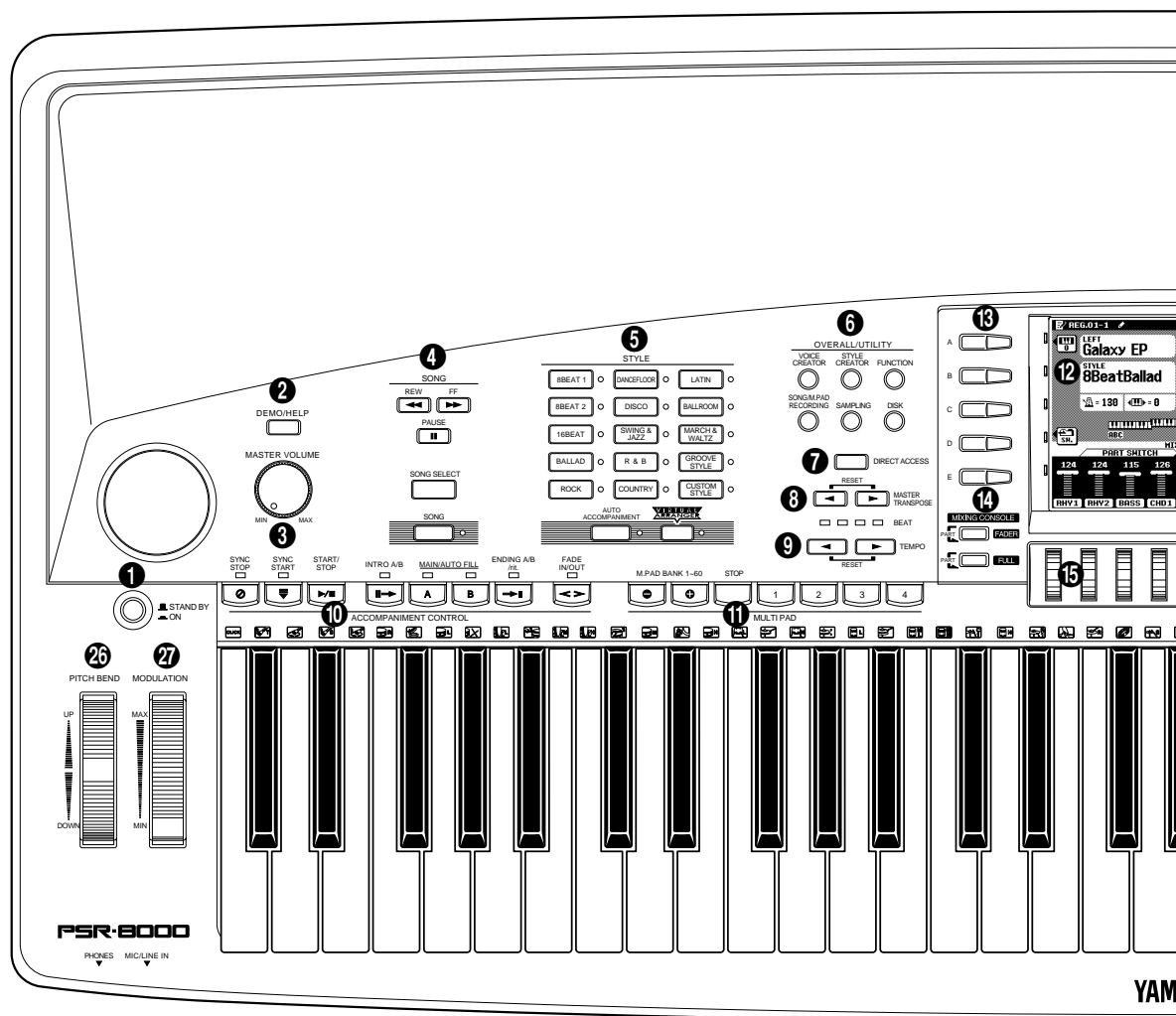

- ❶ STAND BY/ON Button ..... page 17
- ❷ DEMO/HELP Button ..... pages 17, 20
- ❸ MASTER VOLUME Control ..... page 17
- ❹ SONG Buttons ..... page 100  
REW, FF, PAUSE, SONG SELECT, SONG
- ❺ STYLE Buttons ..... pages 28, 36  
8BEAT1, 8BEAT2, 16BEAT, BALLAD, ROCK,  
DANCEFLOOR, DISCO, SWING & JAZZ, R & B,  
COUNTRY, LATIN, BALLROOM, MARCH &  
WALTZ, GROOVE STYLE, CUSTOM STYLE,  
AUTO ACCOMPANIMENT, VIRTUAL AR-  
RANGER
- ❻ OVERALL/UTILITY Buttons  
..... pages 51, 62, 88, 105, 119, 122, 139  
VOICE CREATOR, STYLE CREATOR,  
FUNCTION, SONG/M.PAD RECORDING, SAM-  
PLING, DISK
- ❼ DIRECT ACCESS Button ..... pages 20, 170
- ❽ MASTER TRANSPOSE ◀, ▶ Buttons .... page 26
- ❾ TEMPO ◀, ▶ Buttons ..... page 35
- ❿ ACCOMPANIMENT CONTROL Buttons .. page 33  
SYNCHRO STOP, SYNCHRO START, START/  
STOP, INTRO A/B, MAIN/AUTO FILL A/B, END-  
ING A/B/rit., FADE IN/OUT
- ⓫ MULTI PAD Buttons ..... page 119  
M.PAD BANK 1~60, STOP, 1—4
- ⓬ Liquid Crystal Display (LCD) ..... page 19
- ⓭ LCD (A—J) Buttons ..... page 19
- ⓮ MIXING CONSOLE Buttons ..... page 19  
FADER, FULL

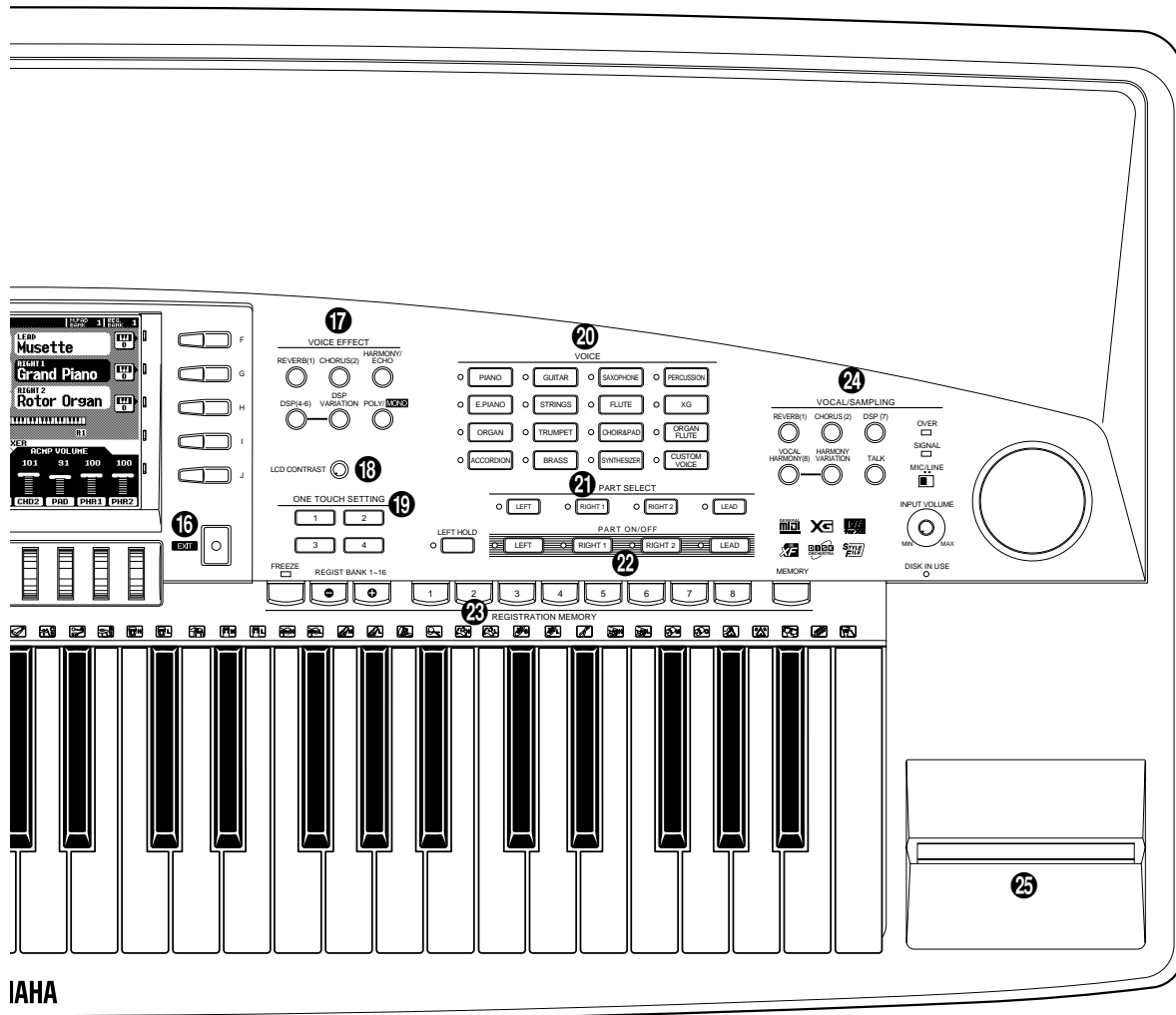

IAHA

- 15 LCD dials ..... page 19
- 16 EXIT Button ..... page 20
- 17 VOICE EFFECT Buttons ..... page 26  
 REVERB (1), CHORUS (2), HARMONY/ECHO,  
 DSP (4—6), DSP VARIATION, POLY/MONO
- 18 LCD CONTRAST Control ..... page 20
- 19 ONE TOUCH SETTING (1—4) Buttons ... page 38
- 20 VOICE Buttons ..... page 25  
 PIANO, E.PIANO, ORGAN, ACCORDION, GUI-  
 TAR, STRINGS, TRUMPET, BRASS, SAXO-  
 PHONE, FLUTE, CHOIR&PAD, SYNTHESIZER,  
 PERCUSSION, XG, ORGAN FLUTE, CUSTOM  
 VOICE
- 21 PART SELECT Buttons ..... page 22  
 LEFT, RIGHT 1, RIGHT 2, LEAD
- 22 PART ON/OFF Buttons ..... page 25  
 LEFT HOLD, LEFT, RIGHT 1, RIGHT 2, LEAD
- 23 REGISTRATION MEMORY Buttons ..... page 46  
 FREEZE, REGIST BANK 1~16, 1—8, MEMORY
- 24 VOCAL/SAMPLING Buttons & Controls  
 ..... pages 83, 88  
 REVERB(1), CHORUS(2), DSP(7), VOCAL  
 HARMONY(8), HARMONY VARIATION, TALK  
 OVER Indicator, SIGNAL Indicator, MIC/LINE  
 Switch, INPUT VOLUME Control
- 25 Disk Drive ..... page 139
- 26 PITCH BEND Wheel ..... page 27
- 27 MODULATION Wheel ..... page 27

# Connections & Music Stand

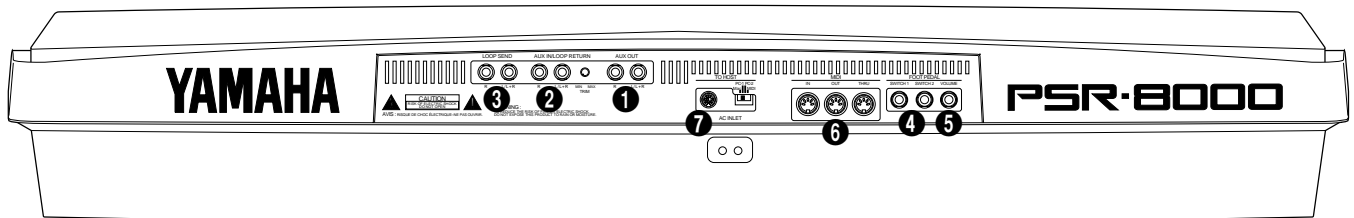

## ■ The PHONES Jack .....

A standard pair of stereo headphones can be plugged in here for private practice or late-night playing. The internal stereo speaker system is automatically shut off when a pair of headphones is plugged into the **PHONES** jack.

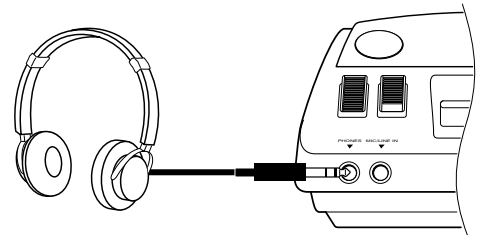

## ■ The MIC/LINE IN Jack .....

The PSR-8000 includes a microphone/line input jack into which just about any standard microphone or line-level source with a 1/4" phone plug can be plugged (a dynamic microphone with an impedance of 250 ohms is recommended). The microphone or line input can be used with the PSR-8000's vocal harmony and sampling functions (pages 83 and 88, respectively). The panel **MIC/LINE** switch should be set according to the type of source used, and the **INPUT VOLUME** control can be used to adjust the level of the microphone or line input signal. The **SIGNAL** and **OVER** indicators on the panel aid in setting the ideal input level: the green **SIGNAL** indicator should light when an input signal is present, but if the red **OVER** indicator lights the level should be reduced by using the **INPUT VOLUME** control, and if this is not sufficient, by reducing the level of the source signal itself.

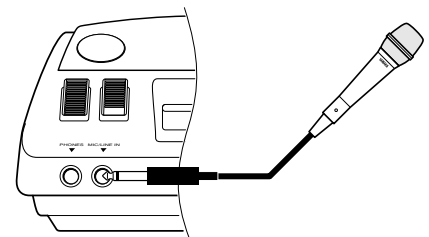

### NOTE

- The Yamaha MZ106s microphone is recommended for use with the PSR-8000.
- The level of the microphone sound may vary considerably according to the type of microphone used.
- Turn the **INPUT VOLUME** control all the way down when connecting or disconnecting a microphone.
- Placing a microphone which is connected to the PSR-8000 too close to the PSR-8000 speakers (or those of an external sound system connected to the PSR-8000) can cause feedback. Adjust the microphone position, and the **MIXING CONSOLE MIC** volume level or **MASTER VOLUME** control level if necessary, so that feedback does not occur.

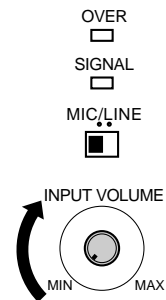

## ① The AUX OUT L/L+R and R Jacks .....

The rear-panel **AUX OUT L/L+R** and **R** jacks deliver the output of the PSR-8000 for connection to a keyboard amplifier, stereo sound system, a mixing console, or tape recorder. If you will be connecting the PSR-8000 to a monaural sound system, use only the **L/L+R** jack. When a plug is inserted into the **L/L+R** jack only, the left- and right-channel signals are combined and delivered via the **L/L+R** jack so you don't lose any of the PSR-8000 sound.

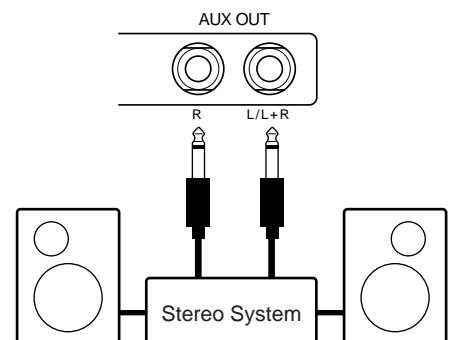

## 2 The AUX IN L/L+R and R (LOOP RETURN) Jacks with TRIM Control .....

The rear-panel **AUX IN L/L+R** and **R** jacks accept input from an external instrument or audio source, or the processed signal returned from an external effect unit fed by the PSR-8000 **LOOP SEND** jacks, below. The signal received at the **AUX IN/ LOOP RETURN** jacks is mixed with PSR-8000 sound and delivered via the speaker system. Use the **L/L+R** jack only for monaural input.

The **TRIM** control allows the input sensitivity of the **AUX IN L/L+R** and **R (LOOP RETURN)** jacks to be adjusted for optimum level matching with the connected equipment.

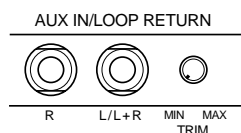

- **Never return the output from the AUX OUT jacks to the AUX IN jacks. Also never return the output from an external device fed by the AUX OUT jacks to the AUX IN jacks. Doing so can result in a feedback loop which damage the PSR-8000 and connected equipment.**

## 3 LOOP SEND L/L+R and R Jacks .....

These jacks deliver the output of the PSR-8000 for connection to external signal processing devices such as reverb or equalizer units. The output from the signal processor can be returned to the **AUX IN/LOOP RETURN** jacks, described above. When feeding a monaural device connect only the **L/ L+R** jack. When a plug is inserted into the **L/L+R** jack only, the left- and right-channel signals are combined and delivered via the **L/L+R** jack.

When a plug is inserted into the **LOOP SEND L/L+ R** jack the internal signal flow is interrupted and only the signal returned to the **AUX IN (LOOP RETURN)** jacks — see above — will appear at the PSR-8000 speakers, headphones, and **AUX OUT** jacks. No sound will be produced if the return signal is not fed to the **AUX IN (LOOP RETURN)** jacks.

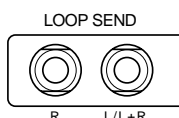

### Loop Signal Flow Diagram

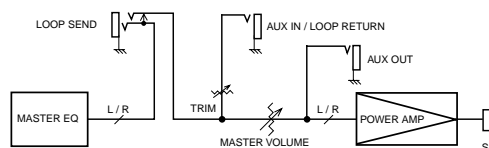

### LOOP SEND/LOOP RETURN Connection Examples

#### 1. Stereo Effect Processor

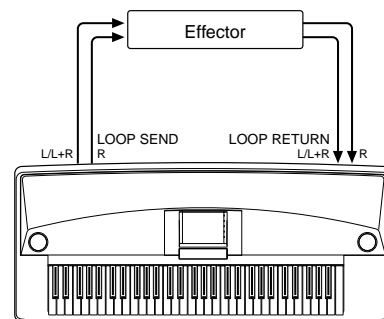

#### 2. Mixer and Additional Sources

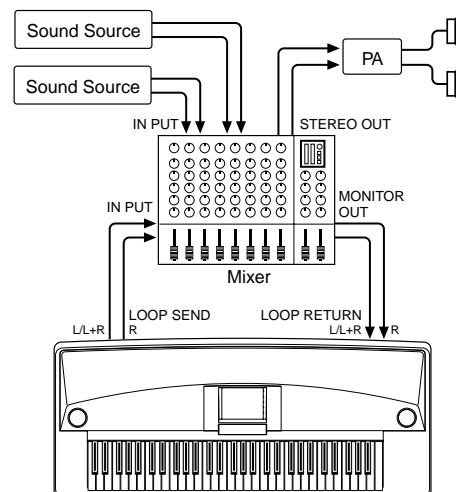

In this setup the sound of the PSR-8000 itself as well as the external sources will be reproduced via the PSR-8000 amplifier and speakers, allowing the PSR-8000 to function as a convenient stage monitor system.

## 4 FOOT PEDAL SWITCH 1 and 2 Jacks

One or two optional Yamaha FC5 footswitches connected to these jacks can be used to control sustain and a range of other important functions. Refer to the “FOOT SWITCH 1” and “FOOT SWITCH 2” functions described on page 124.

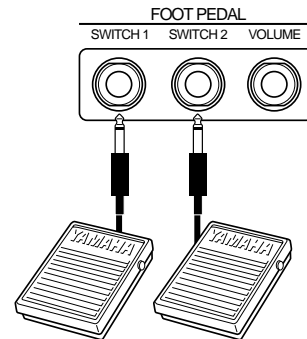

## 5 FOOT PEDAL VOLUME Jack

An optional Yamaha FC7 Foot Controller can be connected to this jack to allow foot volume (expression) control. The foot controller can be assigned to control overall volume or the volume of individual accompaniment and/or voices via the “FOOT VOLUME” function — page 124.

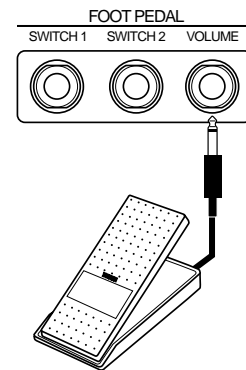

## 6 MIDI IN, THRU and OUT Connectors

The **MIDI IN** connector receives MIDI data from an external MIDI device (such as a MIDI sequencer) which can be used to control the PSR-8000. The **MIDI THRU** connector re-transmits any data received at the **MIDI IN** connector, allowing “chaining” of several MIDI instruments or other devices. The **MIDI OUT** connector transmits MIDI data generated by the PSR-8000 (e.g. note and velocity data produced by playing the keyboard). More details on MIDI are provided on pages 132, 177. The PSR-8000 can also be connected directly to a personal computer via the **TO HOST** connector, described below, without the need for a MIDI interface.

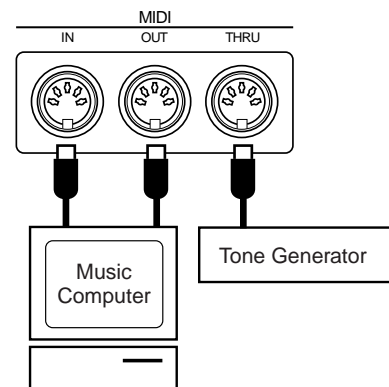

### NOTE

- Be sure to set the **HOST SELECT** switch to **MIDI** when using the MIDI connectors. The MIDI connectors do not function when the **HOST SELECT** switch is in any other position.
- No MIDI transmission or reception occurs in the **SAMPLING** mode.

## 7 TO HOST Connector & HOST SELECT Switch .....

Although the PSR-8000 can be connected to a personal computer via the **MIDI IN/OUT** connectors and a MIDI interface, the **TO HOST** connector and **HOST SELECT** switch allow direct connection to Apple Macintosh or IBM PC/AT personal computers for sequencing and other music applications without the need for a separate MIDI interface.

**NOTE**

- When using the [TO HOST] terminal of the PSR-8000, first turn the power off on both the PSR-8000 and the computer before connecting the cable. After connecting the cable, turn the power of the computer on first, then the PSR-8000.
- When not using the [TO HOST] terminal of the PSR-8000, make sure the cable is disconnected from the [TO HOST] terminal. If the cable is left connected, the PSR-8000 may not function properly.
- When the HOST SELECT switch is set to "Mac", "PC-1", or "PC-2, no data transfer occurs via the MIDI connectors. To use the MIDI connectors for connection via a standard MIDI interface, set the HOST SELECT switch to "MIDI".
- No MIDI or TO HOST transmission or reception occurs in the SAMPLING mode.

### ● Connecting to an Apple Macintosh Series Computer .....

Connect the **TO HOST** connector of the PSR-8000 to the modem or printer port on your Macintosh, depending on which port your MIDI software is using for MIDI data communication, using a standard Macintosh 8-pin system peripheral cable. Set the **HOST SELECT** switch to the "Mac" position.

You may also have to make other MIDI interface settings on the computer side, depending on the type of software you use (refer to your software owner's manual). In any case the clock speed should be set to 1 MHz.

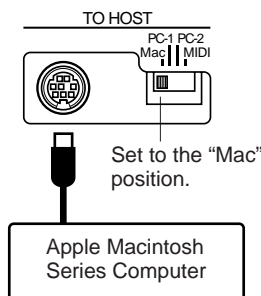

#### "Mac" Cable Connections

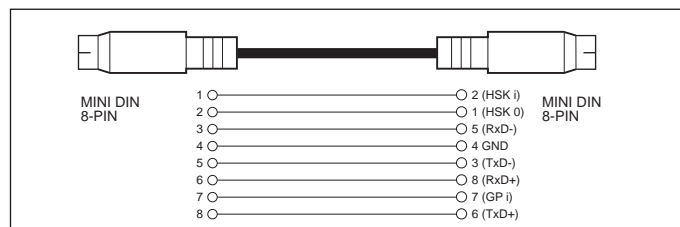

- 8-pin system peripheral cable.
- Data transfer rate: 31,250 bps.

### ● Connecting to an IBM-PC/AT Series Computer .....

Connect the **TO HOST** connector of the PSR-8000 to the RS-232C port on your IBM computer, using a standard 8-pin MINI DIN → 9-pin D-SUB cross cable. Set the **HOST SELECT** switch to the "PC-2" position.

Refer to your software owner's manual for information on any settings you might have to make on the computer side.

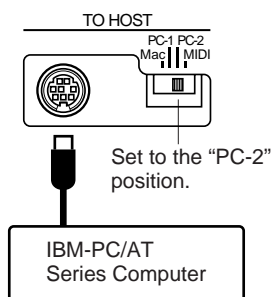

#### "PC-2" Cable Connections

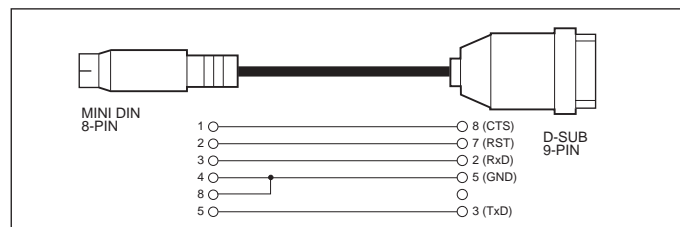

- 8-pin mini DIN → 9-pin D-SUB cable.
- Data transfer rate: 38,400 bps.

**NOTE**

- If your system doesn't work properly with the connections and settings listed above, your software may require different settings. Check your software operation manual and if it requires a 31,250 bps. data transfer rate, set the HOST SELECT switch to "PC-1".
- When using the TO HOST terminal to connect to a personal computer using Windows, a Yamaha MIDI driver must be installed in the personal computer. The Yamaha MIDI driver can be obtained at Yamaha's home page on the World Wide Web, <<http://www.yamaha.co.jp/english/xg/>>.

## Connector Pin Numbers

MINI DIN 8-PIN



D-SUB 9-PIN

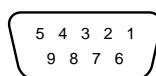

## The Music Stand

The PSR-8000 is supplied with a music stand that can be attached to the instrument by inserting it into the holes at the rear of the speaker panel.

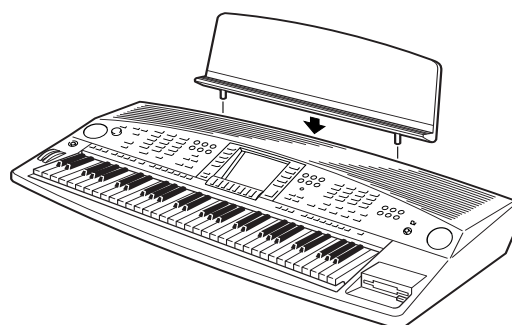



# The Demonstration

To give you an idea of the PSR-8000's sophisticated capabilities, it is programmed with a number of demonstration sequences which can be played in a number of ways.

## 1 Switch ON

Plug the AC power cord into the AC INLET on the rear panel of the PSR-8000, and a convenient AC outlet, then press the [STANDBY] button to turn the PSR-8000 ON.

### NOTE

- Pressing the [STANDBY] button a second time turns the power off.
- Even when the power is "off", the PSR-8000 consumes a minute amount of power in order to maintain some internal memory contents. Be sure to unplug the AC power cord from the AC outlet if you will not be using the PSR-8000 for a long time.



## 2 Set an Initial Volume Level

Set the [MASTER VOLUME] control to a position about a quarter of the way toward the highest setting. You can re-adjust the [MASTER VOLUME] control for the most comfortable overall volume level after playback begins.

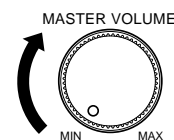

## 3 Press the [DEMO/HELP] Button

Press the [DEMO/HELP] button and the PSR-8000 demo display will appear.

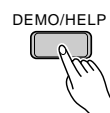

## 4 Select a Play Mode

Use either of the LCD dials under **MODE** on the display to select one of the available play modes.

<b>ALL</b>	All demo songs are played back in sequence.
<b>RANDOM</b>	All demo songs are played back in random order.
<b>SINGLE</b>	Only the selected song is played.

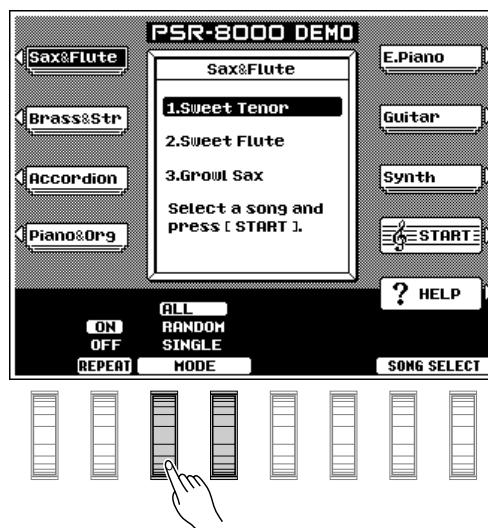

## 5 Select a Song

Press the LCD button corresponding to the category containing of demo song you want to play, then use the same LCD button to select a demo song in that group. You can also use either of the LCD dials under **SONG SELECT** on the display to select any of the demo songs.

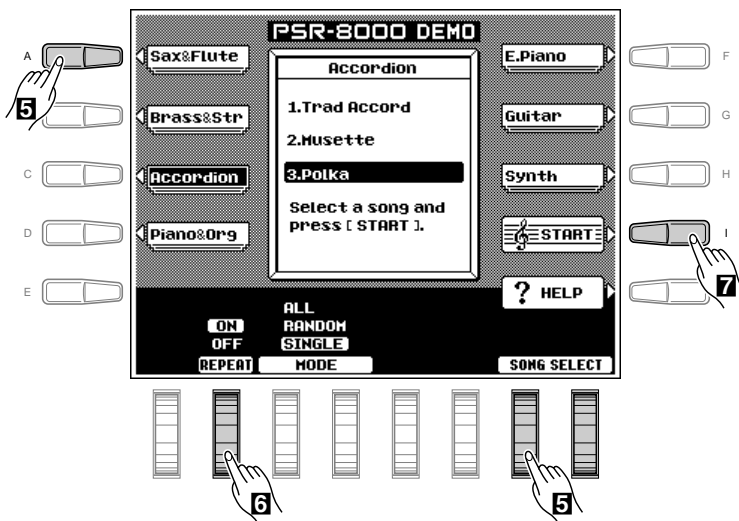

## 6 Turn the Repeat Mode ON or OFF

Use the **REPEAT** LCD dial to turn repeat playback **ON** or **OFF** as required (when ON, the selected song or sequence of songs will be repeated until the **STOP** LCD button is pressed)

## 7 Start & Stop Playback as Required

Press the **START** LCD button to start playback of the selected demo song(s). Press the **STOP** LCD button when you want to stop playback.

## 8 Exit When Done

Press either the **[DEMO/HELP]** button or the **[EXIT]** button to exit from the demo mode and return to the normal play-mode display when you've finished playing the demo songs.



# The PSR-8000 Display & Display-based Controls

The PSR-8000 makes general operation and programming easier than ever with a large backlit LCD display panel and multi-function controls. The 10 LCD (A—J) buttons — five on either side of the display panel — and 8 LCD dials below the display perform the function indicated by the adjacent section of the display.

In the example display shown here, for example, the LCD dial immediately below LEAD on the display can be used to adjust the volume of the LEAD voice. Rotate the dial upward to increase the volume, or rotate the dial downward to decrease the volume.

In the same way, the LCD button immediately to the right of LEAD voice window on the display is used to set the normal octave for the lead voice (“0”), shift it one octave up (“+1”), or one octave down (“-1”).

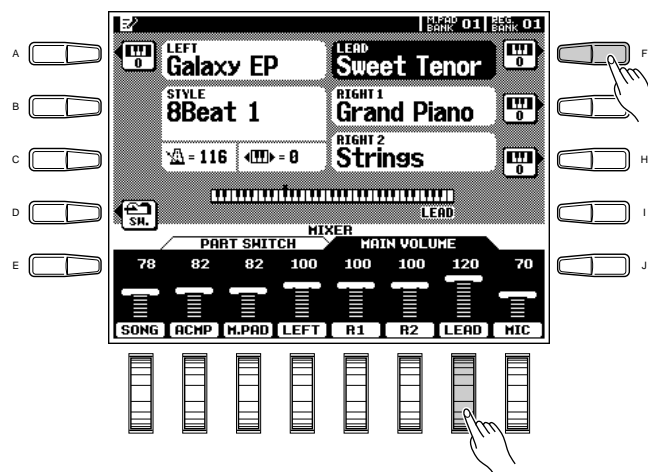

## The MIXING CONSOLE Buttons .....

The lower section of the normal play mode display, shown to the right, provides individual volume controls for the PSR-8000’s song, accompaniment, multi pad, left, right 1, right 2, lead, and microphone sound. Pressing the [FADER] button alternately switches between this display and the individual auto-accompaniment part volume controls: rhythm 1, rhythm 2, bass, chord 1, chord 2, pad, phrase 1, and phrase 2. This is essentially a “mixer” that you will use to achieve the best overall balance for your musical needs.

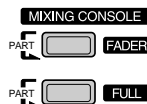

A full-screen mixing console which provides access to a wide range of controls for each part can be selected by pressing the [FULL] button. Full details are provided in the “The Mixing Console” section on page 39.

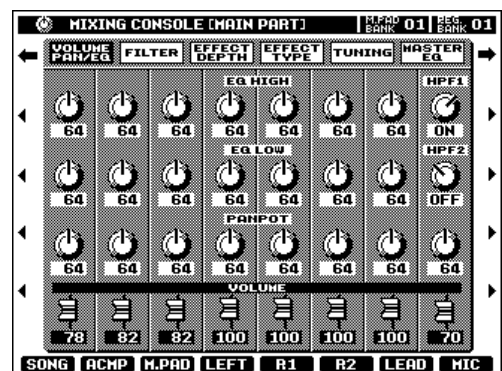
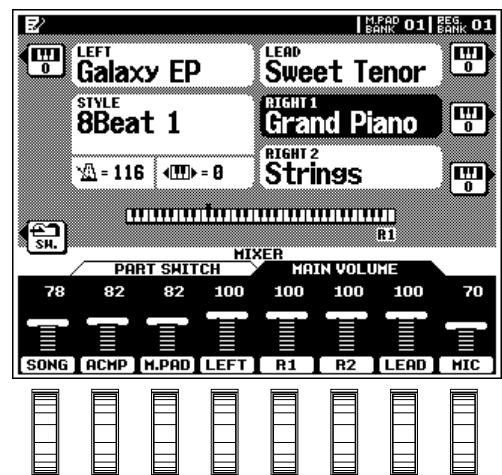

The mixing console controls will disappear when functions which have different displays are selected, but can be instantly recalled without exiting from the current display mode by pressing the [FADER] or [FULL] button. Pressing the [EXIT] button causes the mixer controls to disappear.

**NOTE**

- In the DEMO mode the mixer SONG parameters become DEMO parameters.

## The [EXIT] Button

No matter where you are in the PSR-8000 display hierarchy, the [EXIT] button will return you to the next highest level, or to the normal play mode display.

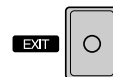

## The [DIRECT ACCESS] Button

Pressing a function button while holding the [DIRECT ACCESS] button will take you directly to a parameter display related to that function. See page 170 for a list of the applicable panel buttons and parameter displays accessed.



## The [LCD CONTRAST] Control

The PSR-8000 display panel is a liquid-crystal type which features a [LCD CONTRAST] control. Use the [LCD CONTRAST] control to set the display for optimum legibility.



## The 5-language Help Function

The PSR-8000 provides “on-line help” for its main features and functions.

Press the [DEMO/HELP] button and then the **HELP** LCD button to go to the main help display. Either select an item from the **HELP MENU** by using one of the corresponding LCD dials and then press the “**ENTER**” LCD button, or simply press a panel button to see corresponding help text. If more than one page of help text is available for the selected topic, use the LCD buttons to the right of the display to switch pages as necessary. Press the **RETURN TO HELP MENU** LCD button for more help, or the [EXIT] or [DEMO/HELP] button when you’re ready to exit from the help mode.

**DEMO/HELP**

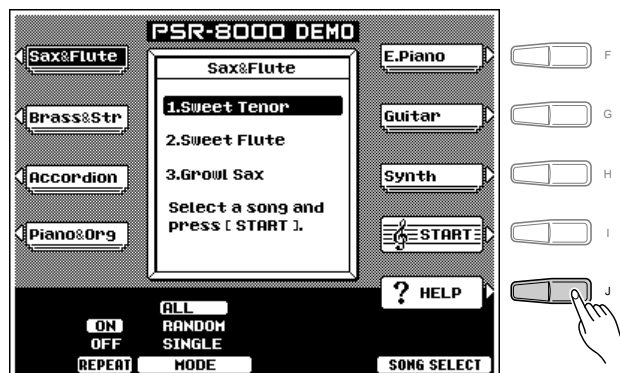

Help text and screen messages are available in five languages: English, German, French, Spanish, and Italian. Use the **LANGUAGE** LCD dials in the help display to select the desired language.



## Display Messages

The large PSR-8000 display panel facilitates operation by making it possible to display comprehensive message and prompts that will guide you through certain operations. When such messages appear, simply follow the instructions as shown.

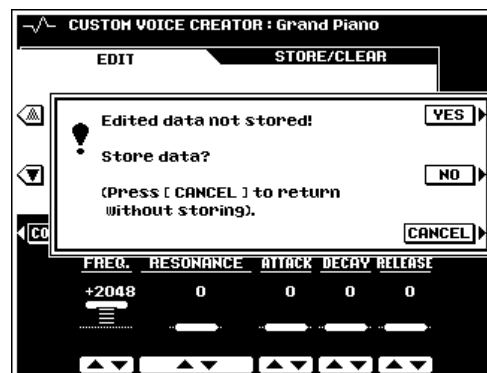

## Name Entry

A number of PSR-8000 functions allow you to enter a name for, for example, a file you will be saving to disk, a custom voice or style, etc. The name entry procedure is essentially the same in all cases (only the maximum number of characters which can be entered will vary). An example display which includes **NAME** entry parameters is shown below (the display shown below can be accessed by pressing one of the **REGISTRATION MEMORY** buttons — [1] ... [8] — while holding the **[DIRECT ACCESS]** button):

Use the ◀ ▶ LCD dial to move the name cursor to the various character positions, then use the **A~Z**, **a~z**, or **0~9...** LCD dial to select the required character for each position. The **A~Z** LCD dial selects capital letters, the **a~z** LCD dial selects lower-case letters, and the **0~9...** LCD dial selects numbers and special characters.

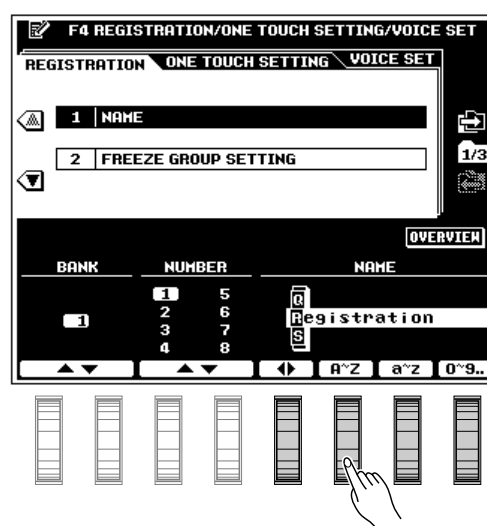

# Playing the PSR-8000

## Before You Begin

Before playing your PSR-8000 for the first time, it might be a good idea to re-initialize it to the original factory settings just in case these have been changed at some point before you receive the instrument. To do this, turn the [STANDBY] switch ON while holding the rightmost key on the keyboard (C6).



- When the above initialization procedure is carried out, all internal data (e.g. REGISTRATION, CUSTOM OTS (One Touch Setting), CUSTOM STYLE, GROOVE STYLE, CUSTOM VOICE, MULTIPAD) will also be initialized and therefore lost!

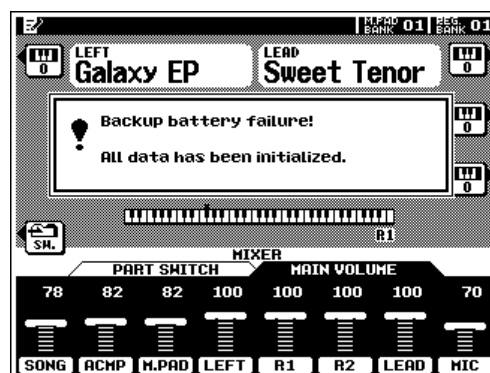

## The PSR-8000 Parts & Voices

The PSR-8000 allows you to individually select and play up to four “parts” at the same time in a number of ways. A range of voices can be assigned to each part.

<b>RIGHT 1, RIGHT 2, &amp; LEAD</b>	The RIGHT 1, RIGHT 2, and LEAD voices can be played over the entire keyboard or to the right of a specified split point (see “NOTE”, below). These voices can be played individually or in any combination. The RIGHT 1, RIGHT 2, and LEAD voices can be selected from a range of voices organized in 15 groups.
<b>LEFT</b>	The LEFT can be played to the left of a specified split point while the RIGHT 1, RIGHT 2, and/or LEAD voices are played to the right of the split point. The LEFT voice can be selected from the same range of voices as the RIGHT and LEAD parts.



- The split point can be set via the SPLIT POINT/FINGERING FUNCTION display described on page 123.
- The SPLIT POINT/FINGERING FUNCTION display can be accessed directly by pressing the [AUTO ACCOMPANIMENT] button while holding the [DIRECT ACCESS] button.

## Part Poly/Mono Modes & Mono Note Priority

Each of the PSR-8000 voice “parts” can be switched to the polyphonic or monophonic mode as required via the **PART SWITCH** display accessed by pressing the **PART** LCD button in the normal play mode while the **FADER** mixer **MAIN PART** display is selected (page 19).

Use the **LEFT**, **RIGHT 1**, **RIGHT 2**, and **LEAD** LCD dials to set the corresponding parts to **POLY** (polyphonic) or any of the three **MONO** (monophonic) note priority modes:

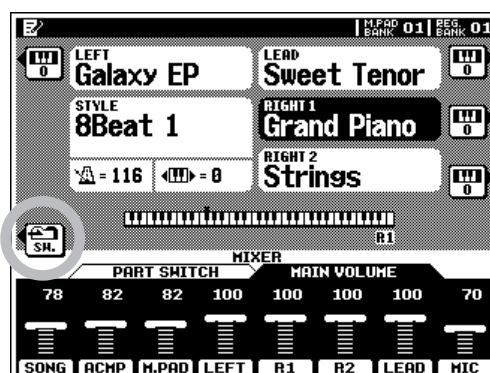

<b>AUTO</b>	When all other parts as set to MONO, last-note priority is automatically selectd. When at least one other part is set to POLY, high-note priority is automatically selected.
<b>HIGH</b>	High-note priority. I.e. the highest note played on the keyboard sounds.
<b>LAST</b>	Last-note priority. I.e. the last note played sounds.

Poly/mono switching for each individual part can also be carried out via the panel **VOICE EFFECT [POLY/MONO]** button. Use the **PART SELECT** buttons to select the part you want to switch, then use the **[POLY/MONO]** button to switch selected part to the POLY (button indicator out) or MONO (button indicator lit) mode. When the MONO mode is selected via the **[POLY/MONO]** button, the last selected MONO note priority mode will be selected.

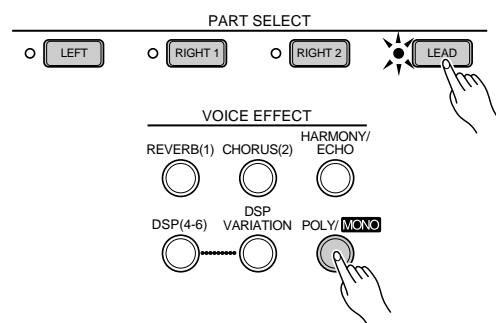

## The XG Voices

Yamaha's XG format is a major new enhancement to the GM (General MIDI) System Level 1 format. It provides a larger number of voices as well as greater expressive control and a wide range of effects. XG also ensures continued compatibility with future instruments and software.

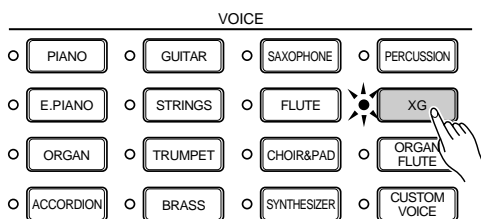

## The Organ Flute Voice

The PSR-8000 has an ORGAN FLUTE voice which can be assigned to the RIGHT, LEAD and LEFT voices in the same way as the other voices. The main difference between the ORGAN FLUTE voice and others is that the ORGAN FLUTE voice can be directly edited via the display accessed by pressing the **[ORGAN FLUTE] VOICE** button. Details on editing the ORGAN FLUTE voice are provided on page 48.

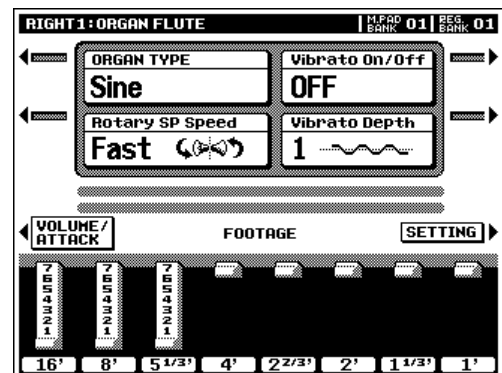
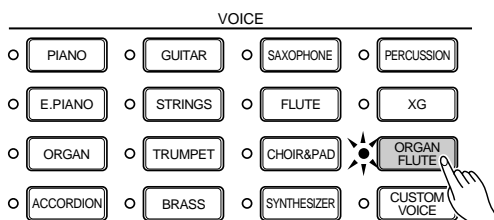

## Keyboard Percussion and Special Effects

When one of the Drum Kit or SFX Kit voices in the [PERCUSSION] group is selected, you can play 61 different drums and percussion instruments or SFX (special effects) sounds on the keyboard. The drum and percussion instruments played by the various keys are marked by symbols above the keys. Some of the instruments in the different drum kit voices sound different even though they have the same name, while others are essentially the same.

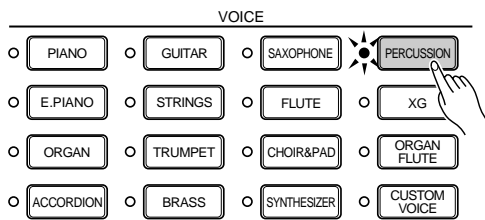

### NOTE

- The instrument symbols above the keyboard correspond to the actual instrument sounds only when the default MIXER and normal play mode OCTAVE settings apply. If the OCTAVE settings are altered the instruments will shift position accordingly.
- See page 166 for a complete listing of the Drum Kit and SFX Kit assignments.
- The Transpose, Tune, Sustain, Harmony, Left Hold, and Modulation functions do not affect the Drum Kit or SFX Kit voices.
- The pitch bend wheel can be used to bend the pitch of the keyboard percussion and SFX voices to create unique musical effects, but it has little effect on some percussion sounds.

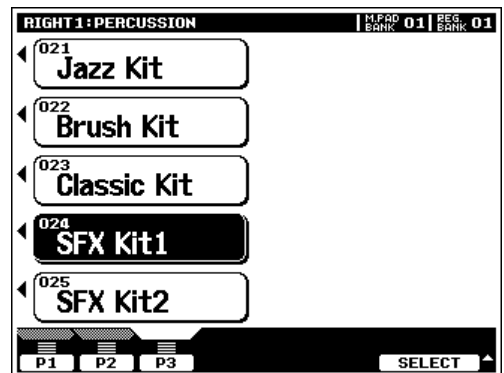
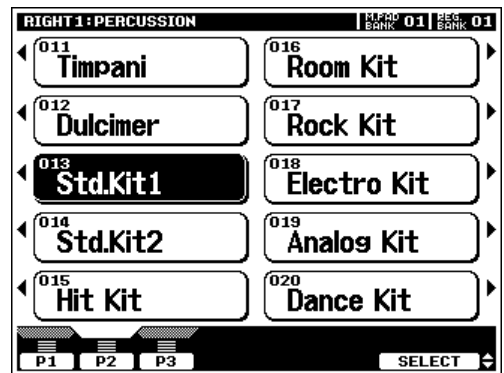

## Procedure: Part Selection and Voice Assignment

### 1 Set Initial Volume Levels

Set the [MASTER VOLUME] control to an appropriate level, and make sure that the LEFT, R1, R2, and LEAD volume levels in the MIXING CONSOLE MAIN VOLUME display are set to their maximum "127" levels (use the corresponding LCD dials to set these volume levels if necessary). You can set the [MASTER VOLUME] control for the most comfortable overall volume level after beginning to play.

### NOTE

- No sound will be produced if all volume levels other than the [MASTER VOLUME] control are set to their minimum values.

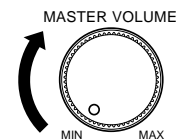



## 2 Select the Parts You Want To Play

Press the [RIGHT 1], [RIGHT 2], [LEAD], and/or [LEFT] PART ON/OFF button(s), turning on the indicators corresponding to the parts you want to play. When a part is turned on the corresponding voice in the main play mode display will be highlighted (i.e. inverted — white characters against a dark background).

**NOTE**

- The more parts you play simultaneously, the fewer the total number of notes that can be played on the keyboard at the same time.
- When the LEFT part is on, the left voice will automatically be transposed up one octave.

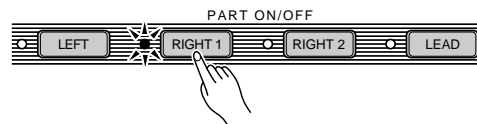

## 3 Select the Part You Want to Assign a Voice To

The PART SELECT buttons above the PART ON/OFF buttons determine which part is selected for voice assignments. If you want to change the voice assigned to the RIGHT 1 part, for example, the [RIGHT 1] PART SELECT indicator must be lit. Each time you turn a part on using the PART ON/OFF buttons, the corresponding PART SELECT button indicator will light automatically. You can also directly press any of the PART SELECT buttons. Only one PART SELECT button can be active at a time.

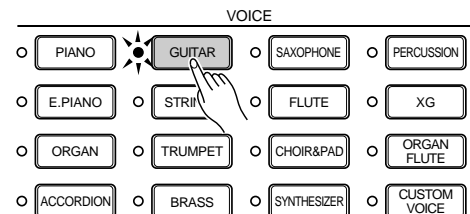
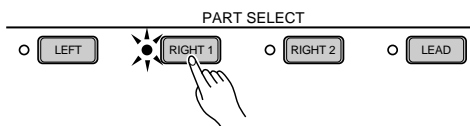

## 4 Select a Voice

Use the VOICE group buttons to select the group from which you want to select a voice. The corresponding voice display will appear.

**NOTE**

- Custom voices which can be selected via the [CUSTOM VOICE] button can be created via the CUSTOM VOICE CREATOR mode described on page 51, or loaded from disk.

Use the page-number LCD dials to select the page containing the voice you want if more than one page is available, then press the LCD button corresponding to the desired voice. You can also use either of the SELECT LCD dials to select any of the voices within the selected group.



## 5 Play & Adjust Volume

You can now play the selected voice or voices on the keyboard. Use the [MASTER VOLUME] control to adjust the overall volume level, and the MIXING CONSOLE MAIN VOLUME LCD dials to set the desired balance between the parts.

## Voice Effects

The PSR-8000 features a sophisticated multi-processor effect system which can add extraordinary depth and expression to your sound. 7 independent digital signal processing (DSP) blocks are provided for effects, plus the Vocal Harmony processor and 5-band Master EQ. Each DSP block applies to a specific part or portion of the PSR-8000 sound. Some DSP block numbers appear next to the panel **VOICE EFFECT** buttons:

<b>REVERB(1)</b>	Overall reverb
<b>CHORUS(2)</b>	Overall chorus.
<b>DSP(4-6)</b>	Independent effects for the RIGHT 1, RIGHT 2, and LEAD parts.

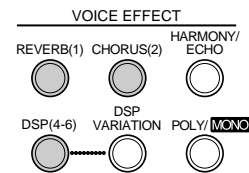

There's also a DSP VARIATION effect which can be applied to DSP(4-6) when the DSP(4-6) effect is on. The **VOICE EFFECT** buttons turn the corresponding effects on (indicator lit) or off (indicator out) for the part currently selected via the **PART SELECT** buttons. Independent **VOICE EFFECT** settings can be made for each part. You can use the default effects, or reprogram them as required via the **FULL MIXING CONSOLE, EFFECT DEPTH** and **EFFECT TYPE** displays (pages 41, 42).

The HARMONY/ECHO effect is described on page 37, and the operation of the **POLY/MONO** button is described on page 22.

## Other Play Mode Functions

The Master Transpose and Octave Change functions described here allow you to change the overall pitch of the PSR-8000, or the octave of individual parts as required. The Left Hold function can be used to provide extra LEFT part sustain.

### Master Transpose .....

This functions allow the overall pitch of the PSR-8000 to be transposed up or down over a range of  $\pm 2$  octaves in semitone steps.

Use the **MASTER TRANSPOSE** [**◀**] and [**▶**] buttons to set the transposition value as required. The current amount of transposition appears in the transpose section of the normal play mode display: from “-24” through “0” to “+24”.

Normal pitch (transpose value “0”) can be recalled at any time by pressing both the **MASTER TRANSPOSE** [**◀**] and [**▶**] buttons simultaneously.

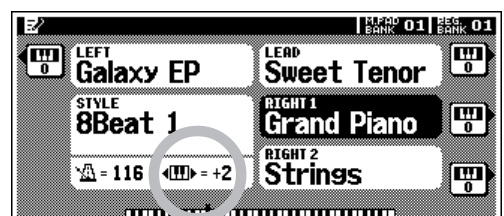
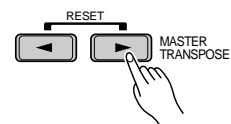

## Octave Change

This function allows the LEFT, RIGHT 1, RIGHT2, and LEAD parts to be independently transposed up or down by one octave.

The **LEFT**, **RIGHT1**, **RIGHT2**, **LEAD** LCD buttons (with the small keyboard icons) directly set the octave of the corresponding part to “+1”, “-1”, and then “0”, in sequence.

### NOTE

- These parameters are separate from the OCTAVE parameters accessed via the FULL mixing console display (page 44). The values of these octave parameters are added to those of the mixer's OCTAVE parameters.
- Some voices may suddenly shift octaves when played at the extreme ends of the keyboard if they are set to a lower or higher octave and/or transpose value than normal. This can also occur when the PITCH BEND wheel is used on extremely low or high notes.
- If you change the transpose or octave change settings while playing one or more notes on the keyboard, the new settings will take effect from the next notes played.



## Left Hold

This function causes the LEFT part voice to be held even when the keys are released. Non-decaying voices such as strings are held continuously, while decay-type voices such as piano decay more slowly (as if the sustain pedal has been pressed). Press the [LEFT HOLD] button so that its indicator lights to engage the LEFT HOLD function. Press the [LEFT HOLD] button a second time so that the indicator goes out to turn LEFT HOLD off.



## Pitch Bend & Modulation Wheels

The **PITCH BEND** and **MODULATION** wheels to the left of the PSR-8000 keyboard can be used to add expressive variation to your sound.

The range of the **PITCH BEND** wheel can be independently set for the LEFT, RIGHT 1, RIGHT 2, and LEAD parts via the **FULL MIXING CONSOLE TUNING** display (page 44).

The type of modulation applied by the **MODULATION** wheel is preset for each of the PSR-8000's preset voices. You can assign your own modulation effects when creating **CUSTOM VOICE** (page 51). The **MODULATION** wheel can be independently turned on or off for the LEFT, RIGHT 1, RIGHT 2, and LEAD parts via the F3: **CONTROLLER, PANEL CONTROLLER** display (page 126).

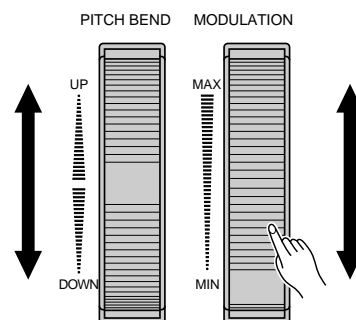

# Using the Accompaniment Section

The PSR-8000 has 214 different preset accompaniment “styles” that can be used to provide fully-orchestrated or rhythm-only accompaniment. You can also create your own “custom” and “groove” styles, as described on pages 62 and 76, respectively. Up to 16 custom styles and 20 groove styles can be retained in the PSR-8000 memory — more can be saved to disk for later loading and use.

The PSR-8000’s sophisticated auto-accompaniment system can provide automated bass and chord backing that is perfectly matched to the selected accompaniment style.

**NOTE**

- The supplied floppy disk includes additional style files which can be used after being loaded into the PSR-8000 (see page 140 for loading instructions).

## Procedure: Auto Accompaniment

### 1 Turn AUTO ACCOMPANIMENT ON

Press the [AUTO ACCOMPANIMENT] button so that its indicator lights, thereby turning the AUTO ACCOMPANIMENT mode on.

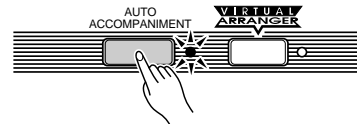

**NOTE**

- Rhythm-only accompaniment will be produced if you don't turn the [AUTO ACCOMPANIMENT] button on.
- The maximum number of notes that can be played simultaneously on the PSR-8000 keyboard is reduced when the AUTO ACCOMPANIMENT feature is used.

### 2 Select the Desired Fingering Mode

Select the desired auto accompaniment fingering mode via the **SPLIT POINT/FINGERING FUNCTION** display described on page 123. The operation of each mode is described in “Auto Accompaniment Fingering Modes”, page 30.



- Press the [AUTO ACCOMPANIMENT] button while holding the [DIRECT ACCESS] button to jump directly to the SPLIT POINT/FINGERING display (page 123).

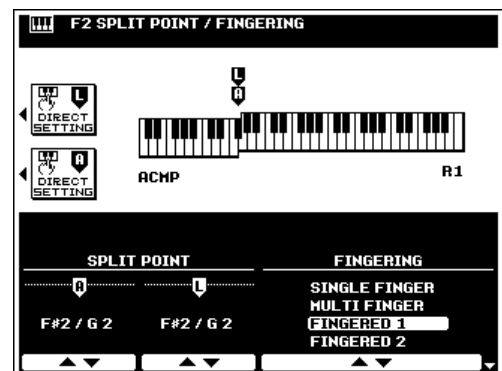

### 3 Select a Style

The PSR-8000 has 214 preset styles organized in 13 groups (see the “Style List” on page 168).

Use the **STYLE** group buttons to select the group from which you want to select a style. The corresponding style display will appear.

Use the page-number LCD dials to select the page containing the style you want if more than one page is available, then press the LCD button corresponding to the desired style. You can also use either of the **SELECT** LCD dials to select any of the styles within the selected group.

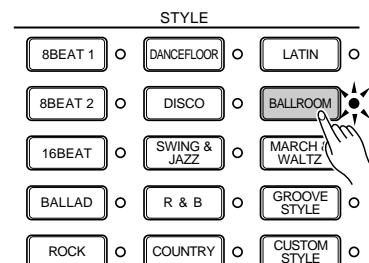

The PSR-8000 automatically determines the voices to be used for the accompaniment bass and chords according to the accompaniment style you select.

**NOTE**

- Custom and groove styles which can be selected via the [CUSTOM STYLE] and [GROOVE STYLE] buttons can be created as described on pages 62 and 76, respectively, or loaded from disk.
- Styles loaded from the floppy disk provided with the PSR-8000 or optional SFF (Style File Format) disks can also be used as CUSTOM STYLES.

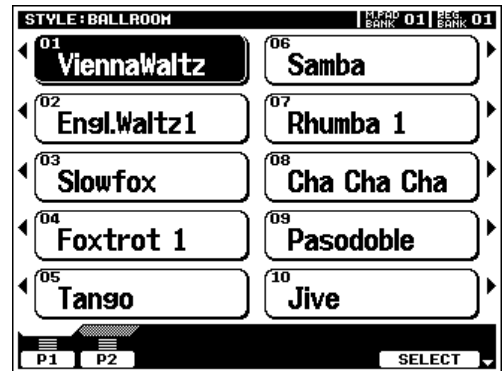

## 4 Set the Tempo

If necessary, set the playback tempo as required (see “Tempo Control, page 35).

## 5 Start the Accompaniment

Use one of the start modes described in “Auto Accompaniment Start Modes”, below, to start the accompaniment.

## 6 Play On the AUTO ACCOMPANIMENT Section Of the Keyboard

As soon as you play any chord that the PSR-8000 can “recognize” on the AUTO ACCOMPANIMENT section of the keyboard (to the left of the auto accompaniment split point — F#2 by default), the PSR-8000 will automatically begin to play the chord along with the rhythm and an appropriate bass line. The accompaniment will continue playing even if you release the left-hand keys. See “Auto Accompaniment Fingering Modes”, below, for information on the individual fingering modes.

If the MANUAL BASS mode is selected only the rhythm accompaniment will play automatically, and the bass voice set for the style can be played on the AUTO ACCOMPANIMENT section of the keyboard.

**NOTE**

- The AUTO ACCOMPANIMENT section split point can be changed via the SPLIT POINT/FINGERING FUNCTION display, described on page 123.
- The appropriate chord and bass note will sound if you play in the AUTO ACCOMPANIMENT section of the keyboard while the AUTO ACCOMPANIMENT function is on but the accompaniment is stopped (but not in the FULL KEYBOARD and MANUAL BASS modes).
- The four LED dots of the TEMPO display provide a visual indication of the selected tempo.



- The SPLIT POINT/FINGERING display can be accessed directly by pressing the [AUTO ACCOMPANIMENT] button while holding the [DIRECT ACCESS] button.

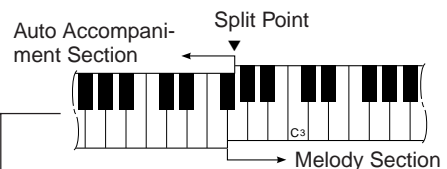

## 7 Select the MAIN A and B Sections as Required

Select the MAIN A and MAIN B sections as required. Appropriate fill-ins will be generated automatically (see “The MAIN A and MAIN B Sections and Fill-ins”, page 34).

## 8 Stop the Accompaniment

The accompaniment can be stopped at any time by pressing the [START/STOP] button. Press the [ENDING A/B /rit.] button if you want to go to the ending section and then stop. A different ending will play depending on whether you go to the ending from the MAIN A or MAIN B section. Press the [ENDING A/B /rit.] button while the ending section is playing to produce a “ritardando” ending — i.e. the tempo gradually slows down during the ending.

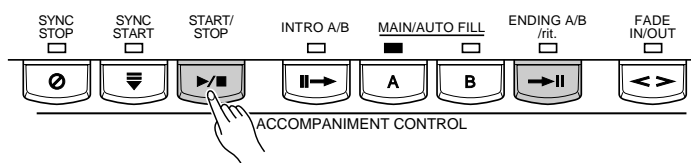

## Auto Accompaniment Fingering Modes

The PSR-8000 AUTO ACCOMPANIMENT feature has six different fingering modes which can be selected via the **SPLIT POINT/FINGERING FUNCTION** display described on page 123. Operation of each mode is described below.

### ● SINGLE FINGER

Single-finger accompaniment makes it simple to produce beautifully orchestrated accompaniment using major, seventh, minor and minor-seventh chords by pressing a minimum number of keys on the AUTO ACCOMPANIMENT section of the keyboard. The abbreviated chord fingerings described below are used:

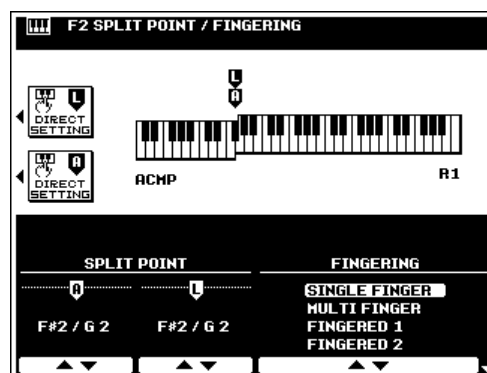

- For a major chord, press the root key only.



- For a minor chord, simultaneously press the root key and a black key to its left.



- For a seventh chord, simultaneously press the root key and a white key to its left.



- For a minor-seventh chord, simultaneously press the root key and both a white and black key to its left.



### ● MULTI FINGER

The MULTI-FINGER mode automatically detects SINGLE FINGER or FINGERED 1 chord fingerings, so you can use either type of fingering without having to switch fingering modes.

#### NOTE

- To use SINGLE FINGER minor, minor-seventh, or seventh fingerings in the MULTI FINGER mode, be sure to play the closest white/black key(s) to the root of the chord.

## ● FINGERED 1

The FINGERED 1 mode lets you finger your own chords on the AUTO ACCOMPANIMENT section of the keyboard, while the PSR-8000 supplies appropriately orchestrated rhythm, bass, and chord accompaniment in the selected style.

The FINGERED 1 mode will accept the following chord types:

Chord Name [Abbreviation]	Normal Voicing	Display for root "C"
Major [M]	1 - 3 - 5	C
Add ninth [(9)]	1 - 2 - 3 - 5	C(9)
Sixth [6]	1 - (3) - 5 - 6	C6
Sixth ninth [6(9)]	1 - 2 - 3 - (5) - 6	C6(9)
Major seventh [M7]	1 - 3 - (5) - 7 or 1 - (3) - 5 - 7	CM7
Major seventh ninth [M7(9)]	1 - 2 - 3 - (5) - 7	CM7(9)
Major seventh add sharp eleventh [M7(#11)]	1 - (2) - 3 - #4 - 5 - 7 or 1 - 2 - 3 - #4 - (5) - 7	CM7#11
Flatted fifth [(b5)]	1 - 3 - b5	C(b5)
Major seventh flatted fifth [M7b5]	1 - 3 - b5 - 7	CM7b5
Suspended fourth [sus4]	1 - 4 - 5	Csus4
Augmented [aug]	1 - 3 - #5	Caug
Major seventh augmented [M7aug]	1 - (3) - #5 - 7	CM7aug
Minor [m]	1 - b3 - 5	Cm
Minor add ninth [m(9)]	1 - 2 - b3 - 5	Cm(9)
Minor sixth [m6]	1 - b3 - 5 - 6	Cm6
Minor seventh [m7]	1 - b3 - (5) - b7	Cm7
Minor seventh ninth [m7(9)]	1 - 2 - b3 - (5) - b7	Cm7(9)
Minor seventh eleventh [m7(11)]	1 - (2) - b3 - 4 - 5 - (b7)	Cm7_11
Minor major seventh [mM7]	1 - b3 - (5) - 7	CmM7
Minor major seventh ninth [mM7(9)]	1 - 2 - b3 - (5) - 7	CmM7_9
Minor seventh flatted fifth [m7b5]	1 - b3 - b5 - b7	Cm7b5
Minor major seventh flatted fifth [mM7b5]	1 - b3 - b5 - 7	CmM7b5
Diminished [dim]	1 - b3 - b5	Cdim
Diminished seventh [dim7]	1 - b3 - b5 - 6	Cdim7
Seventh [7]	1 - 3 - (5) - b7 or 1 - (3) - 5 - b7	C7
Seventh flatted ninth [7(b9)]	1 - b2 - 3 - (5) - b7	C7(b9)
Seventh add flatted thirteenth [7(b13)]	1 - 3 - 5 - b6 - b7	C7b13
Seventh ninth [7(9)]	1 - 2 - 3 - (5) - b7	C7(9)
Seventh add sharp eleventh [7(#11)]	1 - (2) - 3 - #4 - 5 - b7 or 1 - 2 - 3 - #4 - (5) - b7	C7#11
Seventh add thirteenth [7(13)]	1 - 3 - (5) - 6 - b7	C7(13)
Seventh sharp ninth [7(#9)]	1 - #2 - 3 - (5) - b7	C7(#9)
Seventh flatted fifth [7b5]	1 - 3 - b5 - b7	C7b5
Seventh augmented [7aug]	1 - 3 - #5 - b7	C7aug
Seventh suspended fourth [7sus4]	1 - 4 - (5) - b7	C7sus4
One plus two plus five [1+2+5]	1 - 2 - 5	C1+2+5

### NOTE

- Notes in parentheses can be omitted.
- If you play any three adjacent keys (including black keys), the chord sound will be canceled and only the rhythm instruments will continue playing (CHORD CANCEL function).
- Playing a single key or two same root keys in the adjacent octaves produces accompaniment based only on the root.
- A perfect fifth (1 + 5) produces accompaniment based only on the root and fifth which can be used with both major and minor chords.
- The chord fingerings listed are all in "root" position, but other inversions can be used — with the following exceptions:  
m7, m7b5, 6, m6, sus4, aug, dim7, 7b5, 6(9), m7\_11, 1+2+5.
- Inversion of the 7sus4 chord is not recognized if the 5th is omitted.
- The AUTO ACCOMPANIMENT will sometimes not change when related chords are played in sequence (e.g. some minor chords followed by the minor seventh).
- Two-note fingerings will produce a chord based on the previously played chord.

## Example for “C” chords

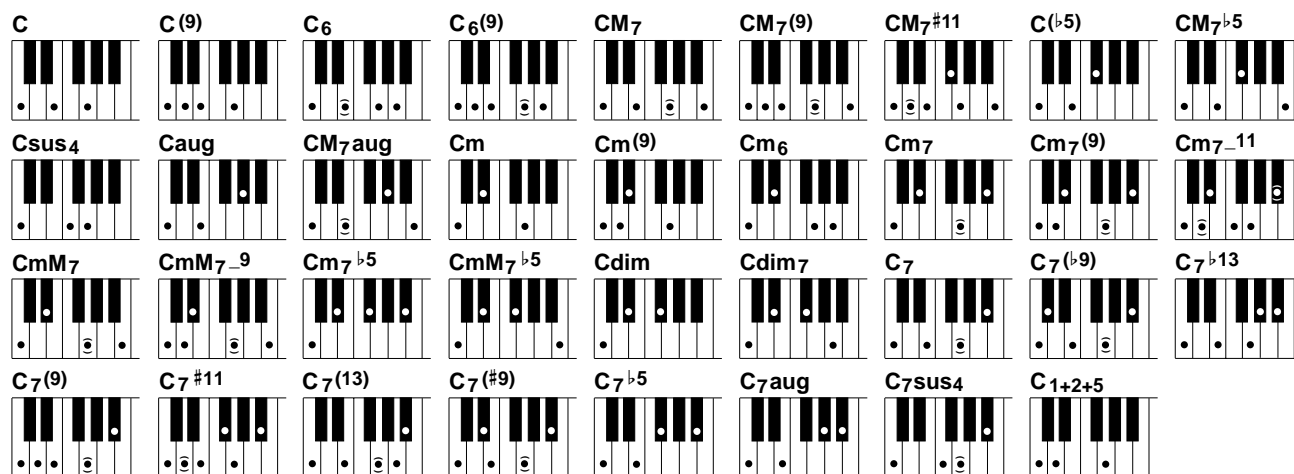

### ● FINGERED 2

This mode accepts the same fingerings as the FINGERED 1 mode, but the lowest note played in the AUTO ACCOMPANIMENT section of the keyboard is used as the bass root, allowing you to play “on bass” or “fraction” chords (in the FINGERED 1 mode the root of the chord is always used as the bass root).

### ● FULL KEYBOARD

When this advanced auto-accompaniment mode is engaged the PSR-8000 will automatically create appropriate accompaniment while you play just about anything, anywhere on the keyboard using both hands. You don’t have to worry about specifying the accompaniment chords. Although the FULL KEYBOARD mode is designed to work with many songs, some arrangements may not be suitable for use with this feature. Try playing a few simple songs in the FULL KEYBOARD mode to get a feel for its capabilities.

### ● MANUAL BASS

In this mode only the rhythm accompaniment will play automatically, and the bass voice set for the style can be played on the AUTO ACCOMPANIMENT section of the keyboard. No chord detection occurs.

#### NOTE

- Chord detection occurs at approximately 8th-note intervals. Extremely short chords — less than an 8th note in length — may therefore not be detected.

#### NOTE

- In all fingering modes except MANUAL BASS the name of the detected chord will appear on the display.



## Auto Accompaniment Start Modes

Add variety and interest to your accompaniment taking advantage of the many start variations described below.

### ● Straight Start

Press the [START/STOP] button. If you press the [START/STOP] button, the rhythm will begin playing immediately without bass and chord accompaniment.

**NOTE**

- It is also possible to select the MAIN A or MAIN B section prior to a straight start (MAIN A is the basic style pattern, MAIN B is a variation).



### ● Synchronized Start

Any of the start types can be synchronized to the first note or chord played on the AUTO ACCOMPANIMENT section of the keyboard by first pressing the [SYNC START] button. Pressing the [SYNC START] button alone causes a straight start to occur when the first note or chord is played. Press [SYNC START] and the appropriate MAIN and/or INTRO buttons, as described below, for a synchronized introduction start.

The first dot of the BEAT display above the TEMPO buttons will flash at the current tempo when a synchronized start mode has been selected.

**NOTE**

- The Synchronized Start function can be cancelled before the accompaniment is actually started by pressing the [SYNC START] button a second time so that its indicator goes out.
- If you press the [SYNC START] button while the accompaniment is playing, the accompaniment will stop and the synchronized start mode will be engaged.
- A Yamaha FC5 footswitch plugged into a rear panel FOOT PEDAL SWITCH 1 or SWITCH 2 jack can also be used to start the accompaniment or control other style playback functions if the appropriate function is assigned to the footswitch using the FOOT CONTROLLER functions described on page 124.

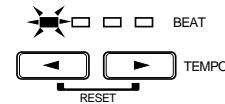
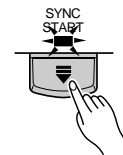

#### 4/4 Time

1st Beat	■ □ □ □	BEAT	■ □ □ □	BEAT
2nd Beat	□ ■ □ □	BEAT	□ ■ □ □	BEAT
3rd Beat	□ □ ■ □	BEAT	□ □ ■ □	BEAT
4th Beat	□ □ □ ■	BEAT	□ □ □ ■	BEAT

#### 3/4 Time

### ● Start with an introduction followed by the MAIN A or MAIN B variation

In addition to two MAIN variations, "A" and "B", each PSR-8000 style has two intro variations which can be followed by either the MAIN A or MAIN B variation.

To start with INTRO A and go to MAIN A, press the MAIN/AUTO FILL [A] button so that its indicator lights (if it is not already lit), then press the [INTRO A/B] button, then use a straight or synchronized start.

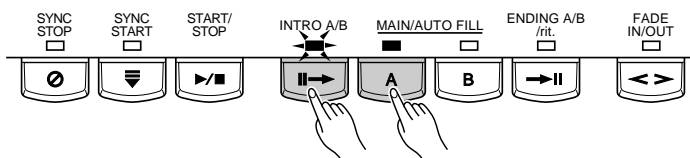

To start with **INTRO B** and go to **MAIN B**, press the **MAIN/AUTO FILL [B]** button so that its indicator lights (if it is not already lit), then press the **[INTRO A/B]** button, then use a straight or synchronized start.

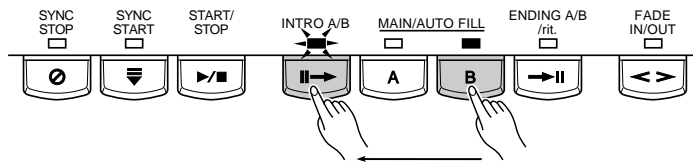

To start with **INTRO A** and go to **MAIN B**, press the **MAIN/AUTO FILL [A]** button so that its indicator lights (if it is not already lit), then press the **[INTRO A/B]** button, then press the **MAIN/AUTO FILL [B]** button. Use a straight or synchronized start.

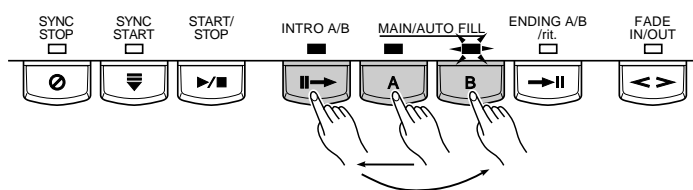

To start with **INTRO B** and go to **MAIN A**, press the **MAIN/AUTO FILL [B]** button so that its indicator lights (if it is not already lit), then press the **[INTRO A/B]** button, then press the **MAIN/AUTO FILL [A]** button. Use a straight or synchronized start.

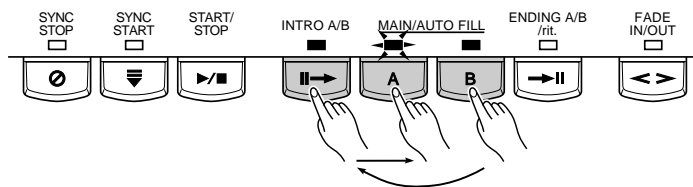

**NOTE**

- The introduction can be cancelled before the accompaniment is actually started by pressing the **[INTRO A/B]** button a second time so that its indicator goes out.

## The MAIN A and MAIN B Sections and Fill-ins

The MAIN A and MAIN B sections can be selected at any time during accompaniment playback by pressing the corresponding button. Whenever you press the **MAIN/AUTO FILL [A]** or **[B]** button during playback, the PSR-8000 will generate an appropriate “fill-in” (one of four types: AA, AB, BA, and BB) which will smoothly connect the current section to the selected section — even if it is the same section. For example, if you press the **MAIN/AUTO FILL [A]** button while the MAIN A section is playing, a fill-in will be produced, then the MAIN A section will continue playing. When you select a different section, the fill-in will begin immediately and the new section will actually begin playing from the top of the next measure unless the **MAIN/AUTO FILL [A]** or **[B]** button is pressed during the last half-beat of the measure, in which case the fill-in will begin from the first beat of the next measure.

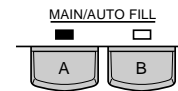

## Tempo Control

When you select a different style while the accompaniment is not playing, the “default” tempo for that style is also selected, and the tempo is displayed on the display in beats per minute. If the accompaniment is playing, the same tempo is maintained even if you select a different style.

You can change the tempo to any value between 32 and 280 beats per minute, however, by using the **TEMPO** [◀] and [▶] buttons. This can be done either before the accompaniment is started or while it is playing. To use the [◀] and [▶] buttons, press either button briefly to decrement or increment the tempo value by one, or hold the button for continuous decrementing or incrementing.

The default tempo for the selected style can be recalled at any time by pressing both the **TEMPO** [◀] and [▶] buttons simultaneously.



## Fade-ins and Fade-outs

The [FADE IN/OUT] button can be used to produce smooth fade-ins and fade-outs when starting and stopping the accompaniment.

To produce a fade-in, press the [FADE IN/OUT] button so that its indicator lights before starting the accompaniment (the fade-in can be cancelled by pressing the button a second time). Then when the accompaniment is started the sound will gradually fade in. The [FADE IN/OUT] indicator will flash during the fade-in, and then go out when full volume has been reached.

To produce a fade-out press the [FADE IN/OUT] button while the accompaniment is playing. The indicator will flash during the fade out, then the accompaniment will stop when the fade-out is complete. The [FADE IN/OUT] button indicator will remain lit for a few seconds after the fade-out, indicating that the fade-in mode is engaged. Press the [FADE IN/OUT] button so that its indicator goes out if you want to disengage the fade-in mode.

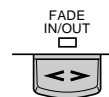

## Synchronized Stop

When the Sync Stop function is engaged, accompaniment playback will stop completely when all keys in the auto accompaniment section of the keyboard are released. Accompaniment playback will start again when a chord is played. The **BEAT** indicators will flash while the accompaniment is stopped.

The Sync Stop function is engaged by pressing the [SYNC STOP] button so that its indicator lights. Press the [SYNC STOP] button again so that its indicator goes out to turn the Sync Stop function off.



### NOTE

- The Sync Stop function can only be used when **AUTO ACCOMPANIMENT** is ON and the **FULL KEYBOARD** fingering mode is *not* selected.

## Accompaniment Volume

Use the various LCD dials in the **MIXING CONSOLE [FADER] ACMP VOLUME** display to set the best balance between the corresponding accompaniment parts. The **MAIN VOLUME** and **ACMP VOLUME** displays can be used to set the balance between the keyboard and accompaniment sound (use the **[FADER]** button to toggle between the **MAIN VOLUME** and **ACMP VOLUME** displays).

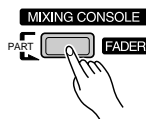

## Accompaniment Part Switching

The **PART SWITCH** buttons accessible via the **MIXING CONSOLE [FADER] ACMP VOLUME** display make it possible to individually mute accompaniment parts to create the blend and accompaniment “size” you want. With the **MIXING CONSOLE [FADER] ACMP VOLUME** display showing, press the LCD “**SW.**” button to bring the **PART SWITCH** display to the front.

Use the LCD dials to turn the corresponding accompaniment parts **ON** or **OFF**, as required.

The **PART SWITCH** display accessed from the **MIXING CONSOLE [FADER] MAIN VOLUME** display additionally includes an **ACMP** parameter with **LARGE** and **SMALL** settings (use the **[FADER]** button to toggle between the **ACMP** and **MAIN** displays). These select different arrangement “sizes” (i.e. more or less parts turned on or off).



## Virtual Arranger

When the Virtual Arranger function is turned on, the **AUTO ACCOMPANIMENT** feature will play a more complex “arrangement” which provides livelier, more melodic accompaniment.

Turn the Virtual Arranger on by pressing the **[VIRTUAL ARRANGER]** button so that its indicator lights. Press the **[VIRTUAL ARRANGER]** button again so that its indicator goes out to turn the function off.

### NOTE

- The Virtual Arranger is only effective when **AUTO ACCOMPANIMENT** is **ON** and the **FULL KEYBOARD** or **MANUAL BASS** fingering mode is not selected.
- The Virtual Arranger will not work with custom styles.

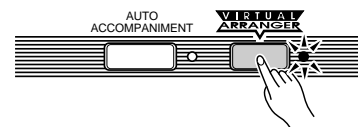

## Harmony/Echo

This feature adds harmony or embellishment notes to a melody you play using the RIGHT 1, LEAD, or RIGHT 2 parts.

The PSR-8000 includes the following Harmony/Echo effects (these are independent from the DSP effects controlled via the mixing console — page 42):

The effect to be applied, the volume of the effect in relation to the keyboard sound, the speed of the repeat-based effects, and the part(s) to which the effect will apply, can all be set via the F5: HARMONY/ECHO function page described on page 129.

The PSR-8000 Harmony/Echo effect is engaged by pressing the **VOICE EFFECT [HARMONY/ECHO]** button so that its indicator lights. To turn Harmony/Echo off press the **[HARMONY/ECHO]** button a second time so that the indicator goes out.



- Press the **[HARMONY/ECHO]** button while holding the **[DIRECT ACCESS]** button to jump directly to the F5: HARMONY/ECHO function page.

### NOTE

- When multiple right-hand notes are played, Harmony/Echo is applied to the last-played note (last-note priority).
- Harmony/Echo effects do not work with the Drum Kit or SFX Kit voices.
- In the AUTO ASSIGN mode, harmony is applied to the highest-priority part among those currently turned on. The part priorities are, from highest to lowest: R1 → LEAD → R2. It is also possible to specify the part to which harmony will be applied via the F5 HARMONY/ECHO function page.

### ● Harmony-based Effects

Types 1 through 8 and 10 are harmony effects which produce harmony based on the current AUTO ACCOMPANIMENT chord (see “NOTES” below for conditions).

### NOTE

- Harmony types 1 through 8 and 10 will function only when AUTO ACCOMPANIMENT is ON and a fingering mode other than FULL KEYBOARD or MANUAL BASS is selected.
- No harmony is produced when no chord is detected.
- Harmony types 1 through 8 and 10 produce unison harmony during auto-accompaniment intros and endings.

### ● Repeat-based Effects & Multi Assign

Effects 9 and 12 through 14 are repeat-based effects which do not depend on AUTO ACCOMPANIMENT chord detection. These effects will function at any time (even when AUTO ACCOMPANIMENT is off), except when the FULL KEYBOARD fingering mode is active.

The MULTI ASSIGN effect (number 11) is a little different, and may need some explanation. MULTI ASSIGN automati-

### The Harmony/Echo Types

1	DUET	8	4WAY OPEN
2	1+5	9	OCTAVE
3	COUNTRY	10	STRUM
4	TRIO	11	MULTI ASSIGN
5	BLOCK	12	ECHO
6	4WAY CLOSE 1	13	TREMOLO
7	4WAY CLOSE 2	14	TRILL

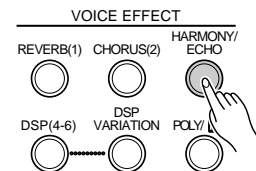
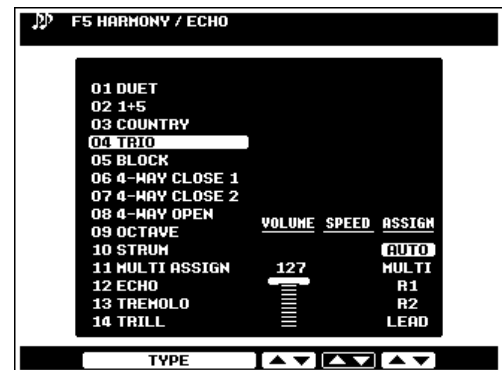

cally assigns notes played simultaneously on the right-hand section of the keyboard to separate parts (voices). The number of parts which can be assigned depends on the number of parts turned ON via the **PART ON/OFF** buttons. If three parts are turned on, then up to three voices can be assigned. If two parts are turned on, then only two voices can be assigned. For example, if the R1, R2, and LEAD parts are turned on and you play a C-major triad on the right-hand section of the keyboard (C-E-G), then “C” will be played by the R1 voice, “E” by the R2 voice, and “G” by the LEAD voice.

**NOTE**

- The TRILL effect applies when two right-hand notes are played.

## One Touch Setting

The PSR-8000 One Touch Setting function provides 4 preset “setups” (i.e. sets of panel settings, including voices, effects, etc.) for each of the 214 preset accompaniment styles. You can also create your own One Touch Setting setups for up to 8 styles (4 setups per style). See page 127 for a complete list of the parameters set by the One Touch Setting function.

To select a One Touch Setting setup for the current style, simply press one of the panel **ONE TOUCH SETTING** buttons: [1] ... [4]. The corresponding panel settings will be recalled and the name of the selected setup will appear in the upper left-hand corner of the display.

To create a custom setup, set the panel controls as required then press one of the **ONE TOUCH SETTING** buttons while holding the [MEMORY] button. Up to four custom setups can be created for up to 8 styles. If the number of customizable setups is exceeded, a message will appear asking if you want to go to the F4: ONE TOUCH SETTING function display (page 127) to overwrite a previous custom setup.

The OVERWRITE function is only available when the F4: ONE TOUCH SETTING function display is entered via the message mentioned above. To overwrite a previous custom setup, first use the **OTS** dial to select the number of the setup you want to overwrite, then press the **OVERWRITE** LCD button.



- Press any **ONE TOUCH SETTING** button while holding the [DIRECT ACCESS] button to jump directly to the F4: ONE TOUCH SETTING function page.

**NOTE**

- OTS can not be recalled during the song play or song record edit mode.
- If OTS is recalled when TALK is on, parameters which are also affected by the TALK function will only take effect when TALK is turned off.
- The PARAMETER LOCK function (F8: UTILITY functions) affects the One Touch Setting function (page 132).
- The REGISTRATION FREEZE function also affects the One Touch Setting function (page 47).
- One Touch Setting does not work with groove styles or custom styles.
- A “pencil” edit symbol will appear next to the One Touch Setting name on the display if any panel settings are changed after a One Touch Setting setup has been recalled.

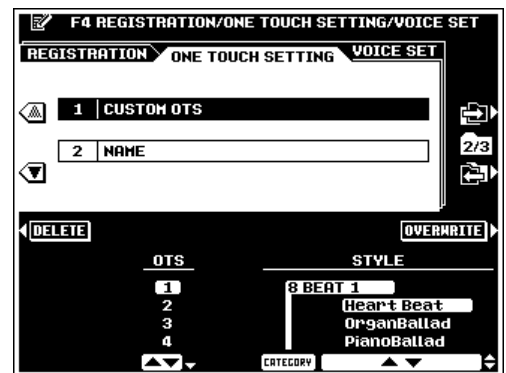
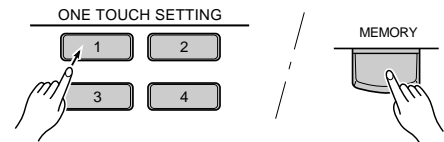
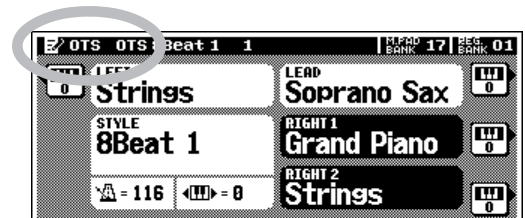
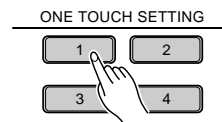

# The Mixing Console

A full-screen mixing console which provides access to a wide range of controls for each main and accompaniment part can be selected by pressing the MIXING CONSOLE [FULL] button (the simpler FADER mixing console is described in appropriate sections of this manual).

## Mixing Console Parameters

The **FULL** mixing console has the following display pages:

<b>VOLUME/PAN/EQ</b> .....	40
<b>FILTER</b> .....	41
<b>EFFECT DEPTH</b> .....	41
<b>EFFECT TYPE</b> .....	42
<b>TUNING</b> .....	44
<b>MASTER EQ</b> .....	45

For the **VOLUME/PAN/EQ**, **FILTER**, **EFFECT DEPTH**, and **EFFECTTYPE** display pages, the **MIXING CONSOLE [FULL]** button alternately selects controls for the main and accompaniment parts.

Use the upper two LCD buttons (“A” and “F”) to select the display page containing the parameters you want to adjust (the selected control group name will be highlighted), press the LCD selector corresponding to the row of controls you want to adjust (the title of the selected row will be highlighted), then use the LCD dial to adjust the desired part as required. Use the dials while holding an LCD selector to simultaneously adjust the corresponding parameter for all parts.

The **FULL** mixing console controls will disappear when functions which have different displays are selected, but can be instantly recalled without exiting from the current display mode by pressing the **[FULL]** button. Pressing the **[EXIT]** button causes the mixer controls to disappear.

**NOTE**

- When a new voice is selected, mixing console settings for the corresponding part may change automatically if the **VOICE SET** function parameters for that part are turned **ON** (page 128).
- Some mixing console display pages are different during **SONG** recording and playback. These variations will be described in the appropriate sections of this manual.

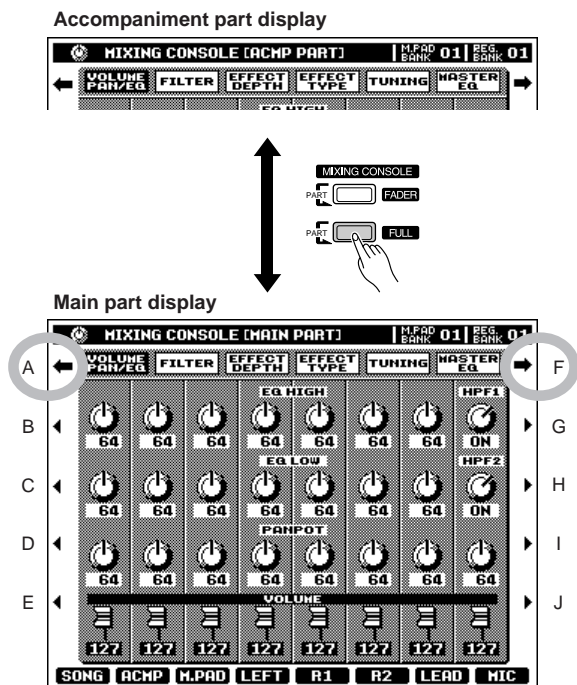

## VOLUME/PAN/EQ

The [FULL] button alternately switches between the [MAIN PART] and [ACMP PART] displays.

When the [MAIN PART] display is selected, the controls in this display page affect the PSR-8000's main parts: **SONG**, **ACMP**, **M.PAD**, **LEFT**, **R1**, **R2**, **LEAD**, and **MIC**.

When the [ACMP PART] display is selected, the controls in this display page affect the PSR-8000's AUTO ACCOMPANIMENT parts: **RHY1**, **RHY2**, **BASS**, **CHD1**, **CHD2**, **PAD**, **PHR1**, and **PHR2**.

### VOLUME

Each part has a graphic volume "fader" that can be set to produce the best "mix" (balance) between the various parts. Use the LCD dials to set the volume levels of the corresponding parts as required. The graphic fader will move to the corresponding position (higher for higher volume, and lower for lower volume).

### PANPOT

Like the pan pots on a mixing console, the **PANPOT** controls can be used to position the sound of the corresponding part anywhere from left to right in the stereo sound field. Use the LCD dials to set the pan positions of the corresponding parts as required.

### EQ LOW

### EQ HIGH

The **EQ HIGH** and **EQ LOW** controls function in the same way as the treble and bass controls on a sound system, boosting or cutting the high or low frequency ranges by the specified amount. Use the LCD dials to set the EQ of the corresponding parts as required.

Note that when the [MAIN PART] display is selected, the **MIC** part does not have the standard **EQ HIGH** and **EQ LOW** controls (see **HPF1** and **HPF2**, below).

### HPF1

### HPF2

These controls appear only when the [MAIN PART] display is selected. Instead of EQ controls the **MIC** channel has two **HPF** (High Pass Filter) switches which turn cascaded high-pass filters ON or OFF. Both of these filters affect the microphone input.

Main part display



Accompaniment part display

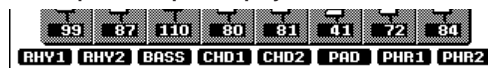



## FILTER

The [FULL] button alternately switches between the [MAIN PART] and [ACMP PART] displays.

When the [MAIN PART] display is selected, the controls in this display page affect the **LEFT, R1, R2, and LEAD** parts.

When the [ACMP PART] display is selected, the controls in this display page affect the PSR-8000's AUTO ACCOMPANIMENT parts: **RHY1, RHY2, BASS, CHD1, CHD2, PAD, PHR1, and PHR2**.

### HARMONIC CONTENT

These controls increase or decrease the harmonic content, giving the sound more or less “punch”. Use the LCD dials to set the harmonic content of the corresponding parts as required.

### BRIGHTNESS

These controls increase or decrease the brightness of the sound. Use the LCD dials to set the brightness of the corresponding parts as required.

Main part display

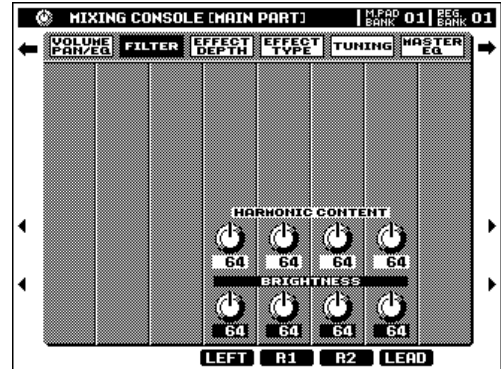

Accompaniment part display



## EFFECT DEPTH

The PSR-8000 has 7 independent digital signal processing (DSP) blocks for effects, plus the Vocal Harmony processor. Each DSP block applies to a specific part or portion of the PSR-8000 sound, as listed below. The DSP block numbers appear in several locations on the PSR-8000 panel and in some of the display screen for easy reference: e.g. **REVERB(1), CHORUS(2), DSP(3), DSP(4)**, etc.

The individual effect types and parameters for each DSP block are accessed via the **EFFECT TYPE** display, below.

### REVERB (DSP1)

The REVERB(1) block applies to the overall PSR-8000 sound. The **REVERB** controls set the reverb depth for the corresponding parts.

### CHORUS (DSP2)

The CHORUS(2) block applies to the overall PSR-8000 sound. The **CHORUS** controls set the chorus depth for the corresponding parts.

Main part display

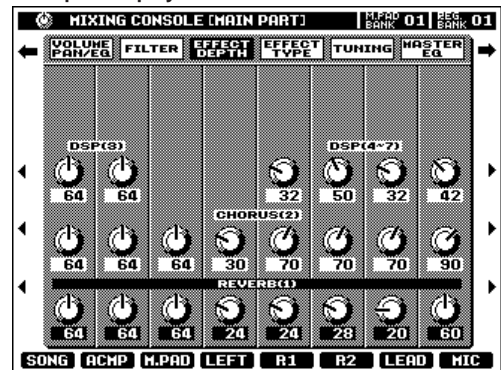

Accompaniment part display

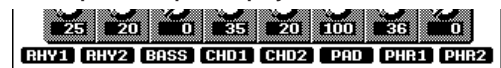

## DSP3

The DSP(3) block applies only to the AUTO ACCOMPANIMENT and SONG playback sound. Use the **DSP(3)** controls to set the effect depth for the corresponding parts.

## DSP4-7

These controls only appear when the [MAIN PART] display is selected DSP blocks (4) through (7) apply to the R1, R2, LEAD, and MIC parts, respectively. Use the **R1**, **R2**, **LEAD**, and **MIC** part controls to set the DSP depth as required.

## EFFECT TYPE

The **EFFECT TYPE** display page includes two “sub pages” — the **TYPE** page and the **PARAMETER** page. Use the **TYPE** or **PARAMETER** LCD button to switch between these sub-pages.

### Type Page

The **TYPE** page allows you to assign individual effects to the any of the PSR-8000’s effect (DSP) blocks.

### EFFECT BLOCK & TYPE

This window lists all 8 DSP processors (including Vocal Harmony) and the effect type currently assigned to each. Use the corresponding LCD dials to select an effect block to which you want to assign an effect type.

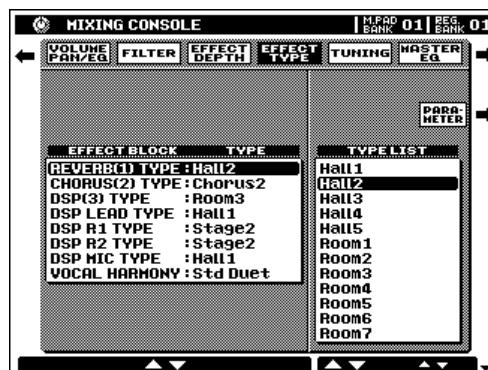

### TYPE LIST

Use the TYPE LIST dials to assign a specific effect to the currently selected **EFFECT BLOCK** (above). Note that the contents of the **TYPE LIST** may be different according to the selected **EFFECT BLOCK**. The “User” effects in the **TYPE LIST** can be programmed as described in “USER SET”, below.

### Parameter Page

To access the individual parameters for each effect, go to the **PARAMETER** page by pressing the **PARAMETER** LCD button.

### BLOCK

### TYPE

These parameters duplicate the **EFFECTBLOCK** and **TYPE** parameters in the **TYPE** page, above. The currently selected **EFFECT BLOCK** and **EFFECTTYPE** appear near the top of the display.

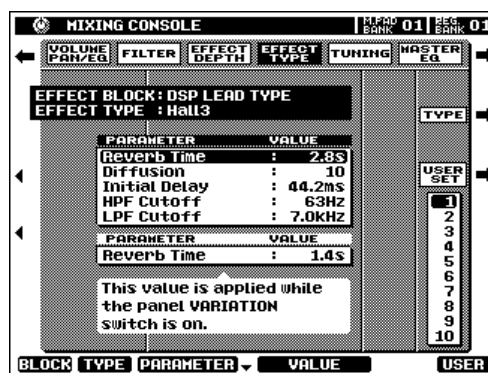

## PARAMETER

Use the **PARAMETER** LCD dials to select the effect parameter you want to edit. The selected parameter will be highlighted.

When the **DSP(LEAD)**, **DSP(R1)**, **DSP(R2)**, or **VOCAL HARMONY** block is selected a second parameter will appear below the main window. This window contains a parameter value which will apply only when the panel **[DSP VARIATION]** or **[HARMONY VARIATION]** button is engaged. Use the **[C]** and **[D]** LCD buttons to switch back and forth between the main and variation parameter windows.

## VALUE

The **VALUE** dials are used to adjust the value of the selected parameter as required.

## LEVEL

The **LEVEL** parameter appears only when the **REVERB(1)** or **CHORUS(2)** effect block is selected, or when the **DSP(3)** effect block is selected and its “Connection” parameter is set to “system”. This is an **EFFECT RETURN** level control.

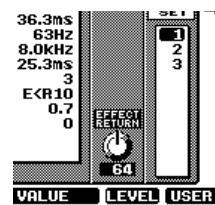

## USER SET

The effect **USER SET** function makes it possible to save up to 3 effect setups individually for the **REVERB**, **CHORUS**, and **VOCAL HARMONY** DSPs, and up to 10 effect setups which are shared by the **LEAD**, **R1**, **R2**, and **MIC** DSPs. The **USER SET** effects appear in the **EFFECT TYPE “TYPE LIST”**.

After editing the effect parameters as required, select a **USER SET** number via the **USER** LCD dial, then press the **USER SET** LCD button to memorize the edited settings in that **USER SET** number. The **USER SET** settings will be retained in memory even when the power is turned off if the **F8: UTILITY MEMORY BACKUP** function (page 131) is turned ON.

The **USER SET** data can be saved to and loaded from disk as described on pages 140, 141.

### ● THE TEMPO-DELAY EFFECTS

- The delay time of the tempo-delay effects (*DelayLCR@T, DelayLR@T, Echo@T, CrossDly@T*) is linked to the **TEMPO** setting. The Delay parameter determines to which beats the delay time will be synchronized: 4th (quarter notes), 4th/3 (quarter note triplets), 4th. (dotted quarter notes), and the same variations for 8th and 16th notes.
- A small amount of noise may be produced if one of the tempo-delay effects is selected and the tempo is changed during playback.
- The upper delay-time limit of the tempo-delay effects is as follows. Once the limit is reached decreasing the tempo will not result in a corresponding increase in delay time.

#### **DSP(3), DSP(LEAD), DSP(R1), DSP(R2)**

- *DelayLCR@T, DelayLR@T*: 1484 msec (eg: Tempo less than 40 bpm @ 4th)
- *Echo@T, CrossDly@T*: 742 msec (eg: Tempo less than 40 bpm @ 8th)

#### **DSP(MIC)**

- *DelayLCR@T, DelayLR@T*: 742 msec (eg: Tempo less than 80 bpm @ 4th)
- *Echo@T, CrossDly@T*: 371 msec (eg: Tempo less than 80 bpm @ 8th)

### NOTE

- *DSP(3)* has a “Connection” parameter which can be set to “system” or “insertion”. When set to “system” the effect applies to the overall accompaniment or song sound. When set to “insertion” a “part” parameter becomes available, allowing the effect to be applied to a specific part.
- See the **PSR-8000 EFFECT PARAMETER LIST** on page 191 in the appendix for details on the parameters available for each effect, value ranges, etc. The *Vocal Harmony* effect types and parameters are described in the “Vocal Harmony” section, page 84.
- Also refer to the “Effect Signal Flow Chart” on page 176 for more information.
- The following abbreviations are used in the effect parameters displays:
  - “cent” → “c”.
  - “degree” → “d”.
- A small amount of noise may be produced when some parameters are edited.
- Extreme effect or EQ settings can result in distorted sound. In such a case use the part volume parameters to reduce the volume of the appropriate part(s).

## TUNING

### TRANSPOSE

The **MASTER TRANSPOSE** parameter duplicates the function of the **MASTER TRANSPOSE** [◀] and [▶] buttons on the PSR-8000 panel. Use the **MASTER TRANSPOSE** dial to set overall PSR-8000 transposition in semitone increments over a  $\pm 24$  semitone range. “0” is standard pitch. Adjusting the **MASTER TRANSPOSE** parameter automatically adjusts the **SONG TRANSPOSE** parameter by the same amount.

Use the **SONG TRANSPOSE** dial to set **SONG** playback transposition in semitone increments over a  $\pm 24$  semitone range. “0” is standard pitch.

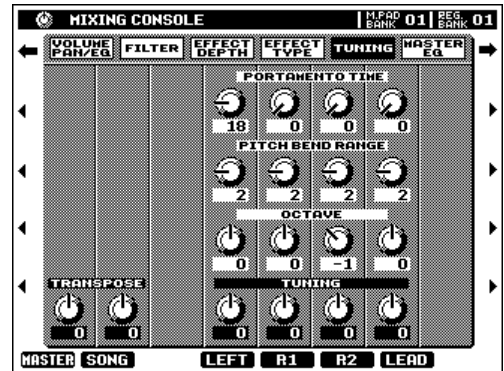

### TUNING

These parameters fine-tune the corresponding parts from “-64” (down a semitone) to “+63” (up a semitone). “0” is standard pitch.

### OCTAVE

These **OCTAVE** parameters are separate from the octave parameters accessed via the normal play mode display (page 27), and have a  $-2 \dots +2$  range as opposed to the  $-1 \dots +1$  range of the play-mode octave parameters. The values of the mixer’s **OCTAVE** parameters are added to those of the corresponding play-mode octave parameters.

### PITCH BEND RANGE

Set the range of the **PITCH BEND** wheel for the corresponding part. The range is from “0” to “12” with each step corresponding to one semitone.

### PORTAMENTO TIME

Set the portamento time for the corresponding parts only when the parts are set to “**MONO**” (page 22). The higher the value the longer the portamento time. The portamento effect (a smooth slide between notes) is produced when the notes are played legato: i.e. a note is held while the next note is played.

## MASTER EQ

The PSR-8000 features a digital 5-band equalizer that can be used to “shape” the overall frequency characteristics of the instrument to create a wide range of tonal variations. Two preset equalizer curves and two programmable “**USER**” curves are provided. The bandwidth and center frequency of each **USER** curve band can be adjusted as required for maximum equalization versatility. The various curves can be selected by pressing the corresponding LCD button.

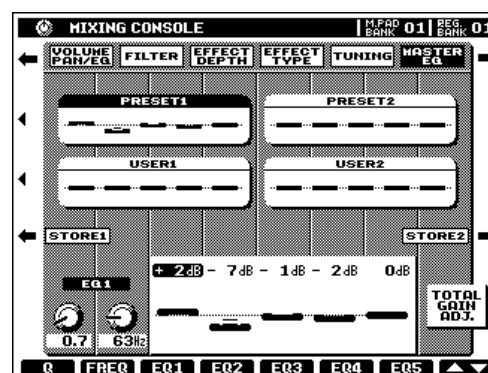

### EQ1 ... EQ5

The **PRESET** and **USER** curves can be edited as required via the corresponding LCD dials — **EQ1** through **EQ5**. Each of the 5 bands can be boosted (“+” values) or cut (“-” values) by up to 12 dB. Any changes are shown graphically via both the controls and the markers in the selected **PRESET** or **USER** curve.

### Q & FREQ

Whenever an EQ band is edited the corresponding EQ value is highlighted and the number of the edited band appears above the **Q** and **FREQ** controls. The **Q** and **FREQ** controls can then be used to adjust the Q (bandwidth) and center frequency of the selected band. The higher the “Q”, the narrower the bandwidth. The available **FREQ** range is different for each band.

### TOTAL GAIN ADJUST

This dial adjusts the overall gain of all EQ bands simultaneously.

### STORE

An edited **PRESET** or **USER** curve can be stored to **USER 1** or **USER 2** by pressing the **STORE 1** or **STORE 2** LCD button, respectively.

#### NOTE

- Extreme digital equalizer settings may result in distorted sound with some voices.
- The **USER** curves are retained in memory even when the power is off if the F8: **UTILITY BACKUP** function is ON.

# Registration Memory

In a sophisticated instrument with as many controls and functions as the PSR-8000, the Registration Memory is a vital feature. It can be used to memorize 128 complete control-panel setups (16 banks, 8 setups each) that you can recall whenever needed simply by pressing a single button.

**NOTE**

- Registration data can be saved to and loaded from floppy disk as required (pages 140, 141).
- See page 171 for a complete listing of the data stored by the Registration Memory.

## Registering the Panel Settings

To register a panel setup first make the desired control settings, then press one of the **REGISTRATION MEMORY** buttons ([1] ... [8]) while holding the **[MEMORY]** button.

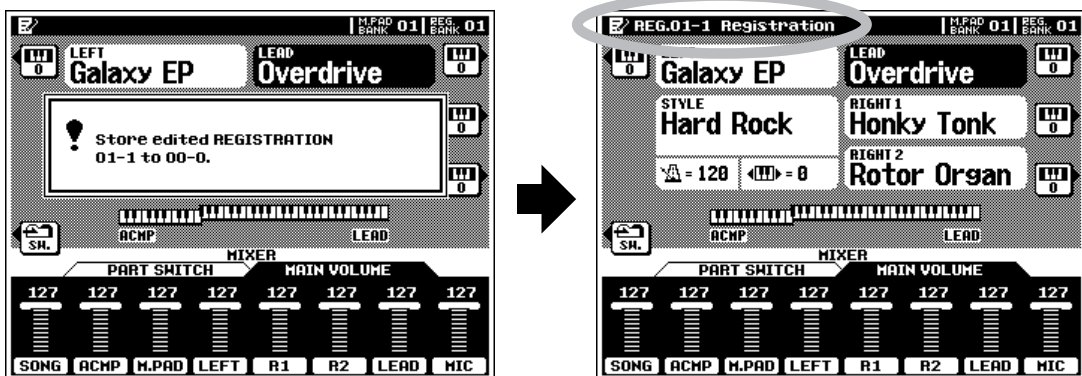
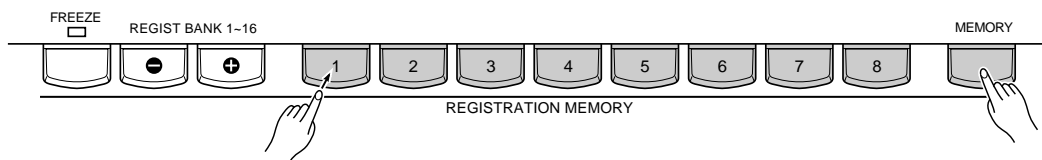

If you want to select a different registration bank prior to registering a setup, use the **REGIST BANK 1-16 [-]** or **[+]** button to select the desired memory bank — the bank number is shown next to **REG. BANK** in the upper right corner of the display.

When a setup is registered, the current bank, registration number and name for that setup will appear in the upper left corner of the display. You can enter original names for each registration setup via the F4: REGISTRATION NAME function display described on page 127.

**NOTE**

- Any previous data in the specified registration memory will be erased and replaced by the registered panel settings.

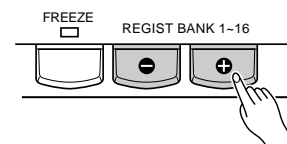

- You can jump directly to the F4: REGISTRATION NAME function display by pressing a REGISTRATION MEMORY button ([1] ... [8]) while holding the [DIRECT ACCESS] button.

## Recalling the Registered Panel Settings

Simply select the appropriate bank using the **REGIST BANK 1-16** [-] or [+] button and press the desired **REGISTRATION MEMORY** button ([1] ... [8]) at any time to recall the memorized settings. The memorized settings are actually recalled only when a **REGISTRATION** button ([1] ... [8]) is pressed — selecting a different bank does not change the settings.



The selected bank, registration number, and name appear in the top left corner of the display.

If any change is made to a setting memorized by the **REGISTRATION MEMORY** feature, a pencil (“edited”) icon will appear to the right of the registration name.



**NOTE**

- **REGISTRATION MEMORY** settings cannot be recalled when the **SONG RECORD EDIT** display is showing.
- **STYLE** data will not be recalled with the **REGISTRATION MEMORY** settings while the **SONG PLAY** mode is engaged or after **STYLE** data has been recorded in the **SONG RECORD** mode.
- **SONG** data will not be recalled with the **REGISTRATION MEMORY** settings during **AUTO ACCOMPANIMENT** or **SONG** playback, or when the **SONG RECORD** mode is engaged.
- If a **REGISTRATION MEMORY** is recalled while the **TALK** function is **ON**, mixer parameters duplicated in the **TALK** settings will only become effective after **TALK** has been turned **OFF**.

## The Freeze Function

If you press the **[FREEZE]** button so that its LED lights, selecting a different registration setup will not change the settings specified in the **F4: REGISTRATION FREEZE GROUP SETTING** function display (page 127).



- You can jump directly to the **F4: REGISTRATION FREEZE GROUP SETTING** function display by pressing the **[FREEZE]** button while holding the **[DIRECT ACCESS]** button.

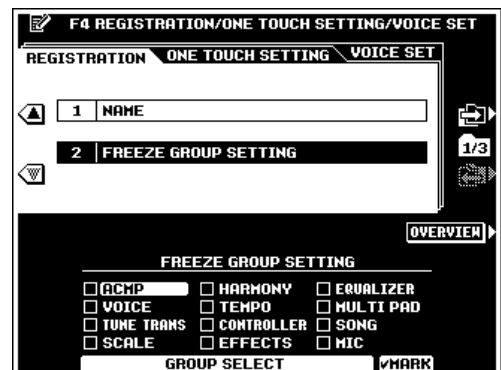

# Organ Flute Voice Editing

In addition to the many organ voices in the [ORGAN] voice category, the PSR-8000 has an ORGAN FLUTE voice which can be assigned to the currently selected part and edited by pressing the VOICE [ORGAN FLUTE] button. The main ORGAN FLUTE editing display will appear when the [ORGAN FLUTE] button is pressed. (If the RETURN LCD button is showing, press it to return to the main display.)

## ORGAN TYPE .....

This parameter specifies the type of organ tone generation to be simulated: Sine or Vintage. Press the **ORGAN TYPE** LCD button to alternately select Sine or Vintage.

## ROTARY SP SPEED .....

The **Rotary SP Speed** LCD button alternately switches between the slow and fast rotary speaker speeds when a rotary speaker effect is selected for the ORGAN FLUTE voice (see “EFFECT & EQ SETTINGS”, below), and the **VOICE EFFECT [DSP(4-6)]** button is turned on (the Rotary SP Speed LCD button has the same effect as the **VOICE EFFECT [DSP VARIATION]** button).

### NOTE

- If an effect other than a rotary speaker effect is selected for the ORGAN FLUTE voice, the Rotary SP Speed LCD button has the same effect as the VOICE EFFECT [DSP VARIATION] button.
- The Rotary SP Speed LCD button may not have the expected effect if the rotary speaker effect “LFO Freq” parameter has been edited.

## VIBRATO ON/OFF .....

This LCD button alternately turns the vibrato effect for the ORGAN FLUTE voice ON or OFF.

## VIBRATO DEPTH .....

The ORGAN FLUTE vibrato depth can be set to any of three levels via the **Vibrato Depth** LCD button. The button sequentially selects a depth of “1”, “2”, or “3”.

### NOTE

- Vibrato speed can be adjusted via the SETTING display — see “EFFECT & EQ SETTINGS”, below.

## FOOTAGE .....

The basic sound of the ORGAN FLUTE voice is edited via FOOTAGE bars corresponding to the LCD dials. If the **FOOTAGE** display is not showing, press the **FOOTAGE** LCD button on the left side of the display. The term “FOOTAGE” is a reference to the fact that the sound of pipe organs is adjusted via “stops” which turn on or off pipes of different lengths (in feet). The longer the pipe, the lower the pitch of the sound, thus the **16'** (16-foot) FOOTAGE bar adjusts the volume of the lowest pitched component of the voice while the **1'** bar adjusts the highest-pitched

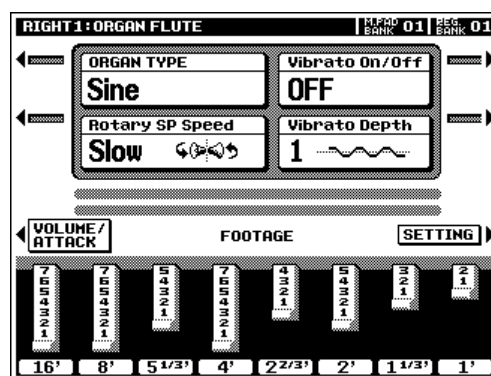



component of the voice. Use the LCD dials to increase or reduce the amount of the corresponding footages to create the desired overall sound. The longer a graphic footage bar, the greater the amount of the corresponding footage added to the sound.

## VOLUME & ATTACK

To access the **VOLUME** and **ATTACK** parameters for the **ORGAN FLUTE** voice, press the **VOLUME/ATTACK** LCD button from the **FOOTAGE** display.

The **VOLUME** control adjusts the overall volume of the **ORGAN FLUTE** voice. The longer the graphic bar, the greater the volume.

The **MODE** control selects the **FIRST** or **EACH** attack mode: in the **FIRST** mode attack will only be applied to the first note in a chord or group of notes played and held simultaneously; in the **EACH** mode attack will be applied equally to all notes.

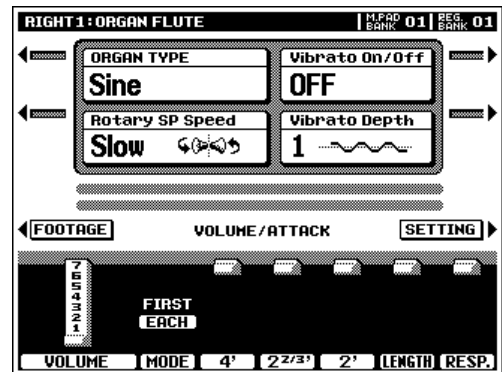

The **ATTACK** controls adjust the attack sound of the **ORGAN FLUTE** voice. The **4'**, **2 2/3'** and **2'** controls increase or reduce the amount of attack sound at the corresponding footages. The longer the graphic bar the greater the attack sound.

The **LENGTH** control affects the attack portion of the sound producing a longer or shorter decay immediately after the initial attack. The longer the graphic bar the longer the decay.

The **RESP.** control affects the sustain portion of the sound, increasing or decreasing the response time of the initial swell and release, based on the **FOOTAGE** controls. The higher the value the slower the swell and release.

## EFFECT & EQ SETTINGS

Press the **SETTING** LCD button on the right side of the display to access the **ORGAN FLUTE** voice effect and EQ settings. When the **SETTING** display is showing, press the **RETURN** LCD button to return to the main **ORGAN FLUTE** editing display.

### ● 1: EFFECT DEPTH & VIBRATO SPEED

This group of parameters includes **ON/OFF** and **DEPTH** settings for **REVERB**, **CHORUS**, and the **DSP** effect selected below. **VIBRATO SPEED** specifies the speed of the vibrato effect controlled by the **Vibrato On/Off** and **Vibrato Depth** LCD dials in the main **ORGAN FLUTE** editing display.

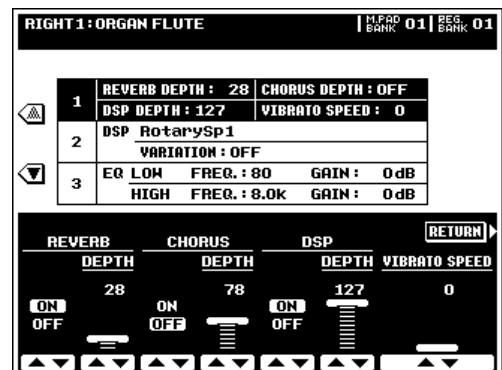

## ● 2: DSP EFFECT

The **DSP TYPE** dials specify the DSP effect type to be applied to the ORGAN FLUTE voice. Normally this will be one of the six available Rotary Speaker effects. If any other type of effect is selected the **Rotary SP Speed** LCD button in the main ORGAN VOICE editing display will not control rotary speaker speed. Instead, it will have the same effect as the **VOICE EFFECT [DSP VARIATION]** button.

The **VARIATION ON/OFF** parameter determines whether the DSP VARIATION will be ON or OFF when the ORGAN FLUTE voice is selected (when the VOICE SET function is ON — page 60).

The **VARIATION PARAMETER** and **VALUE** set the VARIATION parameter value (e.g. “LFO Freq” for a Rotary Speaker effect) when the DSP VARIATION is turned on.

## ● 3: EQ

The EQ parameters specify the **FREQUENCY** and **GAIN** of the **LOW** and **HIGH EQ** bands.

### NOTE

- The ORGAN FLUTE voice settings are retained in memory even when the power is off if the MEMORY BACKUP function is turned ON (page 131).
- If the VOICE SET function DSP and EQ parameters are turned ON (page 60), The effect and EQ settings made in the SETTING display will be automatically recalled when the ORGAN FLUTE voice is selected.

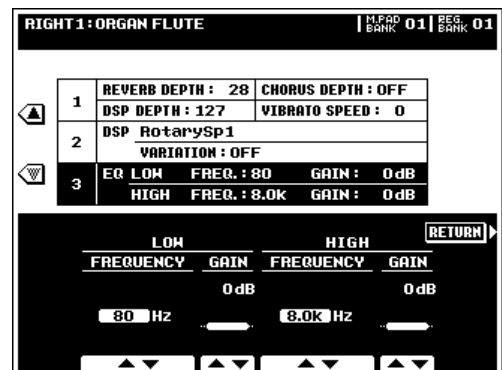
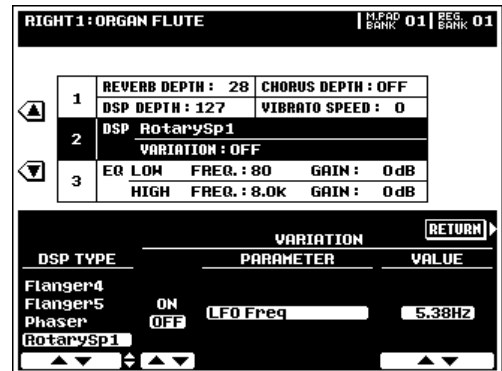

# Custom Voice Creator

This mode makes it possible to create new voices by editing some parameters of the preset voices. Waveform data created using the PSR-8000's SAMPLING feature (page 88) can also be edited to create original voices.\* A simple EASY EDIT mode and full-parameter FULL EDIT mode are available. Up to 32 custom voices can be retained in memory and assigned to the RIGHT 1, RIGHT 2, LEFT, and LEAD voices via the [CUSTOM VOICE] button.

\* Waveform data created using the SAMPLING feature is not actually stored with the CUSTOM VOICE data, but is retained in the wave RAM memory. When the FUNCTION mode AUTO LOAD function (page 131) is ON and a disk containing the appropriate waveform data is loaded, the waveform data for the custom voices will automatically be loaded into the wave RAM memory when the PSR-8000 is turned on. If the AUTO LOAD function is off or the appropriate waveform data is not found when the PSR-8000 is turned on, the corresponding custom voices will automatically be erased.

 NOTE

- Custom voices can be saved to disk using the SAVE TO DISK function (page 141) and reloaded later.

## Procedure: Engaging the Easy/Full Edit Mode

### 1 Engage the CUSTOM VOICE CREATOR Mode

Press the [VOICE CREATOR] button to engage the CUSTOM VOICE CREATOR mode. The CUSTOM VOICE CREATOR MENU display will appear.

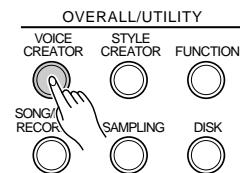

### 2 Select a Preset Voice

Select the preset voice on which the custom voice will be based by using the VOICE buttons in the normal way.

 NOTE

- Previously created CUSTOM VOICES can also be selected for editing.
- ORGAN FLUTE and SFX voices cannot be selected.

### 3 Select Easy or Full Edit

Press the EASY EDIT or FULL EDIT LCD button to go to the corresponding mode. The EASY EDIT mode cannot be selected when a drum kit voice is selected for editing.



## EXITING



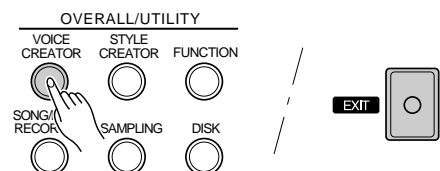

Exit from the CUSTOM VOICE CREATOR mode when done by pressing either the [VOICE CREATOR] or [EXIT] button.



## The Easy Edit Parameters

The EASY EDIT Mode has the following display pages:

<b>EDIT</b> .....	52
<b>STORE/CLEAR</b> .....	53

Use the  and  LCD buttons to the right of the display to select the **EDIT** and **STORE/CLEAR** display pages. Use the  and  buttons to the left of the display to select the various parameters within each page.

The **COMPARE** LCD button can be used during editing to compare the sound of the original voice with the edited voice.

### EDIT

#### FILTER .....

The timbre of the voice can be varied via the **FREQ.** and **RESONANCE** LCD dials. “0” is the preset value for both parameters. “+” **FREQ.** settings produce a brighter sound, while “+” **RESONANCE** settings produce a more “peaky” sound.

#### EG .....

The **EG** (Envelope Generator) parameters affect the volume envelope of the voice.

The **ATTACK** LCD dial sets the time it takes for maximum level to be reached after a key is pressed. “0” is the preset value. “+” settings produce a faster attack.

The **DECAY** LCD dial sets the time it takes to reach the sustain level after the maximum attack level has been reached. “0” is the preset value. “+” settings produce a faster decay.

The **RELEASE** LCD dial sets the time it takes for the sound to diminish to zero after a key is released. “0” is the preset value. “+” settings produce a faster release.

 **NOTE**

- These parameters may have different effects on different voices.

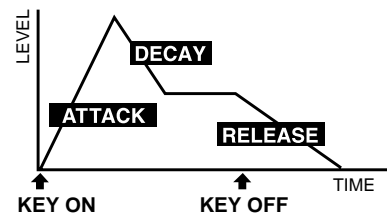
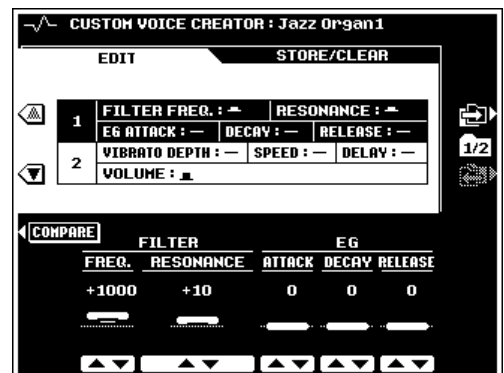

## VIBRATO

Use the **DEPTH**, **SPEED** and **DELAY** LCD dials to set up the vibrato effect. **DELAY** produces a delay between the time a key is pressed and the beginning of the vibrato effect. "0" is the preset value for all parameters. "+" settings increase while "-" settings decrease the range of the effect.

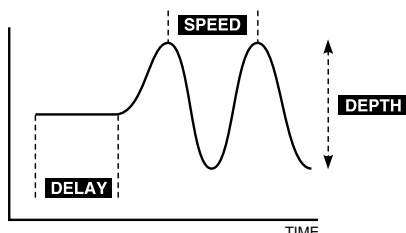

## VOLUME

The **VOLUME** LCD dial adjusts the volume of the voice.

## STORE/CLEAR

### NAME

An original name can be entered for each custom voice. Name entry is described on page 21.

### STORE

Stores the edited custom voice data in the specified custom voice memory location. When this function is selected the size of the current voice and the remaining memory capacity available for voice storage are displayed to the right of the display. The names and sizes of all other voices currently in memory are shown in the lower section of the display.

Use the **STORE** LCD dials to select the custom voice number to which you want to store the newly created custom voice.

Press the **EXECUTE** button, then press **YES** to store the voice when the confirmation display appears (or **NO** to cancel).



## CLEAR CUSTOM VOICE .....

Clears unwanted custom voices from memory, making more memory available for custom voice storage.

Use the **CLEAR** LCD dials to select the custom voice you want to clear.

Press the **EXECUTE** button, then press **YES** to clear the voice when the confirmation display appears (or **NO** to cancel).







**NOTE**

- The custom voice currently being edited cannot be cleared.

## The Full Edit Parameters

The **FULL EDIT** mode can be entered as described on page 51. The following display pages are available:

<b>VOICE</b> .....	55
<b>E1: WAVEFORM</b> .....	56
<b>E2: EG</b> .....	57
<b>E3: FILTER</b> .....	59
<b>E4: LFO</b> .....	59
<b>VOICE SET</b> .....	60
<b>STORE/CLEAR</b> .....	61

Use the  and  LCD buttons to the right of the display to select the desired display page. Use the  and  buttons to the left of the display to select the various parameters within each page.

The **COMPARE** LCD button can be used during editing to compare the sound of the original voice with the edited voice.

## ELEMENT SELECTION (not available for the Drum Kits) .....

PSR-8000 voice can have up to four “elements”. An element is a “layer” of sound which can have an independent waveform, envelope generator settings, and other parameters. When editing in the **E1:WAVEFORM**, **E2:EG**, **E3:FILTER**, or **E4:LFO** pages you can select the element to be edited, set the maximum number of elements to be used by the voice, and mute individual elements via the **ELEMENT** page accessed by the upper right LCD button (“”).

In the **ELEMENT** page the **MAX NUMBER** parameters sets the maximum number of elements to be used by the voice, the **EDIT** parameter sets the element to be edited when you return to the editing pages, and the **MUTE** parameters individually turn the corresponding elements ON or OFF. The circular indicators next to the element numbers in the upper section of the display indicate the mute status for each element.

Press the **RETURN** LCD button to return to the editing pages.

## VOICE

### MASTER VOLUME

Sets the overall volume of the voice.

### INITIAL TOUCH CURVE

The **CURVE** LCD dial provides a choice of four keyboard initial touch sensitivity curves, and the **SENS** LCD dial adjust initial touch sensitivity.

### SCALE CURVE

Use the **SCALE CURVE** LCD dials to select the desired scale (pitch) curve for the PSR-8000 keyboard: **FLAT**, **PIANO 1**, or **PIANO 2**.

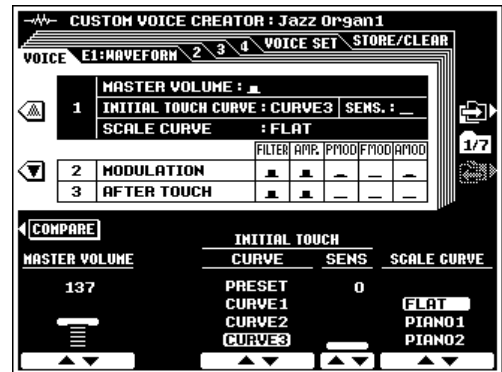

### MODULATION

The **FILTER** and **AMPLITUDE** LCD dials set the amount of filter and volume control applied via the PSR-8000 MODULATION wheel, respectively. The **LFO PMOD** (pitch modulation), **FMOD** (frequency modulation), and **AMOD** (amplitude modulation) LCD dials set the amount of the corresponding LFO modulation type applied via the PSR-8000 MODULATION wheel.

### AFTER TOUCH

The same parameters as for **MODULATION**, above, but applied via keyboard after-touch response.

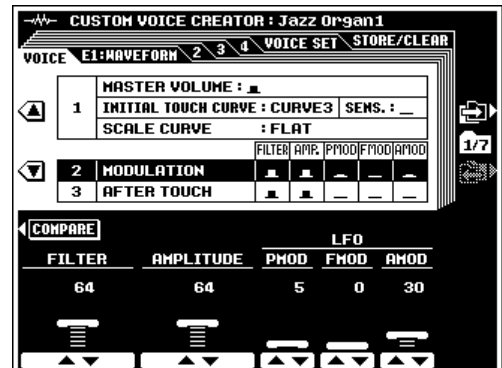

## E1:WAVEFORM

### WAVEFORM (INSTRUMENT for the Drum Kits)

Use the **CATEGORY**, **VOICE**, and **WAVEFORM** LCD dials to select a waveform for the custom voice: the raw sound on which the voice is based. Waveforms created by the **SAMPLING** feature (page 88) are also available for selection in the “**SAMPLING**” **CATEGORY**. When a waveform which has **EG** data is selected, the **EG COPY** LCD button will become available, and pressing it will cause the corresponding **EG** data to be loaded.

When a Drum Kit is selected the **WAVEFORM** parameter is replaced by the **INSTRUMENT** parameter, and individual instruments can be selected rather than waveforms.



### COARSE TUNE/FINE TUNE

These parameters adjust the pitch of the voice. **COARSE** tunes in semitone steps and **FINE** tunes in 1-cent steps (a cent is 1/100th of a semitone).

### VOLUME

Sets the waveform volume.

### KEY ON DELAY

Sets the time before the envelope begins after a key is pressed. The higher the value the longer the delay.

### PAN

The **PAN** LCD dial can be used to position the voice in the center of the stereo sound field, or to the left or right.

### NOTE LIMIT (not available for the Drum Kits)

Specifies the note range over which the voice will sound. The **LOW** dials set the lowest note in the range and the **HIGH** dials set the highest note in the range.

#### NOTE

- When the voice **OCTAVE** is set to a value other than “0”, the range specified by the **NOTE LIMIT** parameters is shifted by the corresponding amount and some notes may not sound. If this happens check the **R1 OCTAVE** setting in the **FULL MIXING CONSOLE TUNING** display.

### VELOCITY LIMIT (not available for the Drum Kits)

Sets the maximum velocity range for the voice. The **LOW** dials set the minimum velocity value and the **HIGH** dials set the maximum velocity value at which the voice will sound. No sound is produced for velocity values outside the specified range.





## E2:EG

**NOTE**

- The **RESET LCD** button resets the currently selected EG parameters to their most basic settings.

### AMP RATE (Amplitude Envelope Rate)

These parameters set the rate of output level variation. Higher values produce faster variation.

<b>ATTACK</b>	Sets the rate of variation from key-on to the maximum attack level.
<b>DECAY1 DECAY2, DECAY3</b>	Set the rate of variation between the maximum attack level and the levels set by the AMP LEVEL DECAY1 and DECAY2 parameters and the final level, respectively.
<b>RELEASE</b>	Sets the rate of variation from the level at key-release to level 0 when SUSTAIN is off.
<b>SUSTAIN</b>	Sets the rate of variation from the level at key-release to level 0 when SUSTAIN is on.

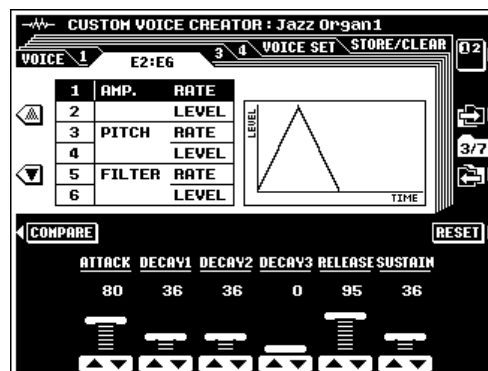

### AMP LEVEL (Amplitude Envelope Level)

These parameters set the amplitude envelope output level.

<b>INITIAL</b>	Sets the initial level of the envelope.
<b>DECAY1, DECAY2</b>	Set the levels after DECAY1 and DECAY2 variation.

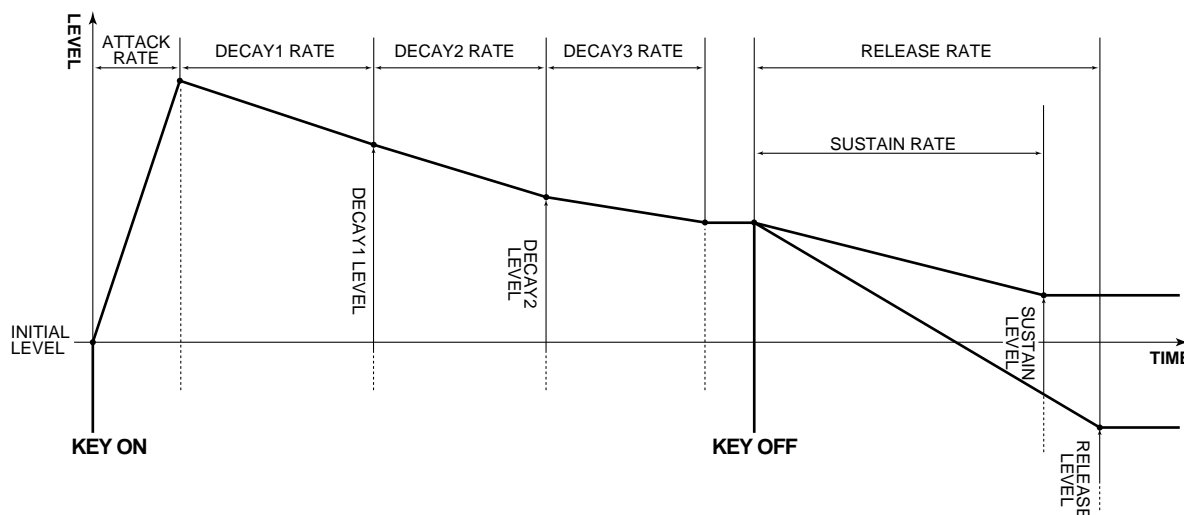

\* Higher rate values produce faster variation.

## PITCH RATE (Pitch Envelope Rate)

These parameters set the rate of pitch variation. Higher values produce faster variation.

<b>DECAY1, DECAY2, DECAY3</b>	Set the rate of variation between the initial pitch envelope level and the levels set by the PITCH LEVEL DECAY1, DECAY2, and DECAY3 parameters, respectively.
<b>RELEASE</b>	Sets the rate of variation from the level at key-release to the level set by the PITCH LEVEL RELEASE parameter.

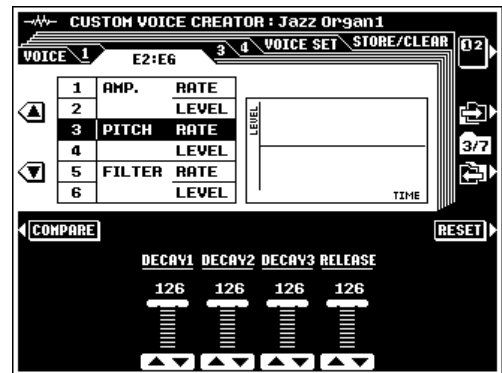

## PITCH LEVEL

These parameters sets the pitch envelope level offset value.

<b>INITIAL</b>	Sets the initial offset of the envelope.
<b>DECAY1, DECAY2, DECAY3</b>	Set the offsets after DECAY1, DECAY2, and DECAY3 variation.
<b>RELEASE</b>	Sets the offset after PITCH RATE RELEASE variation after key-release.

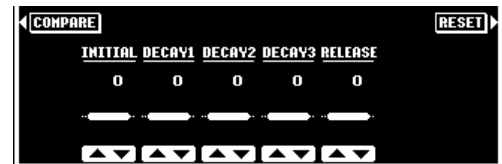

## FILTER RATE

Set the rate of cutoff frequency variation. Higher values produce faster variation.

<b>INITIAL</b>	Sets the length of time the initial filter envelope level will be maintained. Higher values correspond to shorter time.
<b>DECAY1, DECAY2, DECAY3</b>	Set the rate of variation between the initial filter envelope level and the levels set by the FILTER LEVEL DECAY1, DECAY2, and DECAY3 parameters, respectively.
<b>RELEASE</b>	Sets the rate of variation from the offset at key-release to the offset set by the FILTER LEVEL RELEASE parameter when SUSTAIN is off.
<b>SUSTAIN</b>	Sets the rate of variation from the offset at key-release to the offset set by the FILTER LEVEL SUSTAIN parameter when SUSTAIN is on.

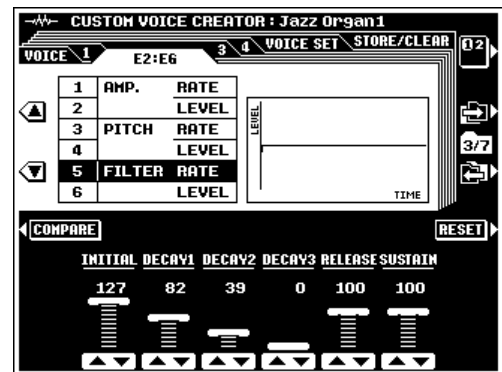

## FILTER LEVEL

These parameters set the amount of variation from the preset cutoff frequency. Level "0" is the preset value.

<b>INITIAL</b>	Sets the initial level of the envelope.
<b>DECAY1, DECAY2, DECAY3</b>	Set the levels after DECAY1, DECAY2, and DECAY3 variation.
<b>RELEASE</b>	Sets the level after FILTER RATE RELEASE variation after key-release when SUSTAIN is off.
<b>SUSTAIN</b>	Sets the level after FILTER RATE SUSTAIN variation after key-release when SUSTAIN is on.



### NOTE

- Some parameter settings may have minimal or no effect with some voices.

## E3:FILTER

**NOTE**

- The **RESET** LCD button resets the currently selected **FILTER** parameters so that no filter effect is applied.

### FILTER1 & FILTER2

These parameters allow you to specify two separate touch-sensitive (dynamic) filter types. The available types are LPF (Low Pass Filters — **LPF1** and **LPF2** for FILTER1), **BPF** (Band Pass Filter), **HPF** (High Pass Filter), and **BEF** (Band Elimination Filter). The **FREQ.** parameters set the initial frequency of the corresponding filters.

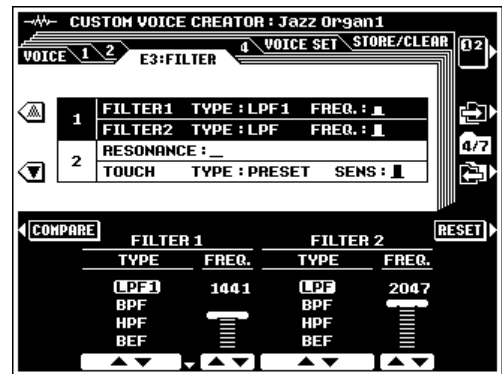

### RESONANCE

Sets the amount of peak resonance applied to **FILTER 1**. Higher values produce more resonant emphasis.

### TOUCH TO FILTER

The **TYPE** parameters specifies the touch-sensitivity curve to be applied to the dynamic filters, and the **SENS** parameters sets the sensitivity of the filters to touch control. Higher values produce higher sensitivity.



## E4:LFO

### LFO (Low Frequency Oscillator)

The **LFO** parameters set the LFO (Low Frequency Oscillator) to produce cyclic pitch, timbre, and amplitude modulation.

<b>PMOD</b>	Sets the pitch modulation depth. Higher values produce deeper modulation.
<b>FMOD</b>	Sets the frequency modulation depth. Higher values produce deeper modulation.
<b>AMOD</b>	Sets the amplitude modulation depth. Higher values produce deeper modulation.
<b>SPEED</b>	Sets the speed of LFO variation.
<b>TYPE</b>	Sets the waveform of the LFO: TRI (triangular) or SAW (sawtooth).



## DELAY (Delay Vibrato)

Delay Vibrato is a vibrato effect based on LFO modulation which has a variable delay between the time a key is played and the beginning of the vibrato effect.

<b>TIME</b>	Sets the delay between key-on and the beginning of LFO PMOD (pitch) modulation. No delay is produced when TIME is set to its minimum value. In this case, only normal vibrato is produced regardless of the RATE value.
<b>RATE</b>	Sets the rate at which LFO PMOD (pitch) modulation is applied after the delay time — i.e. how long it takes to reach maximum modulation level after modulation begins.

## VOICE SET

VOICE SET data are automatically recalled and displayed in the appropriate FULL MIXING CONSOLE displays (page 39) whenever a voice is selected when the VOICE SET DSP and EQ parameters in the F4: REGISTRATION/ ONE TOUCH SETTING/VOICE SET display is ON.

## REVERB, CHORUS, and DSP DEPTH

The **DEPTH** parameters set the depth of the corresponding effect. The **ON/OFF** parameters turn the corresponding effect on or off.



## DSP TYPE and VARIATION

The **DSP TYPE** parameter selects the type of DSP effect, while the **VARIATION ON/OFF** parameter turns effect VARIATION on or off. The **VARIATION PARAMETER** and **VALUE** parameters determine the variation parameter value when the effect VARIATION is turned ON.



## EQ LOW and HIGH

These parameters apply low (bass) and high (treble) EQ to the voice. The **FREQUENCY** parameters set the rolloff frequency of the LOW or HIGH bands.

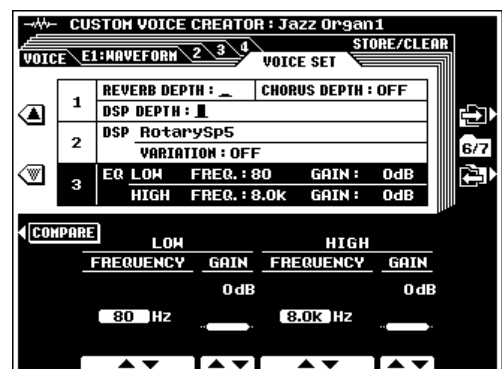

## STORE/CLEAR

### NAME

An original name can be entered for each custom voice. Name entry is described on page 21.

### STORE

Stores the edited custom voice data in the specified custom voice memory location. When this function is selected the size of the current voice and the remaining memory capacity available for voice storage are displayed to the right of the display. The names and sizes of all other voices currently in memory are shown in the lower section of the display.

Use the **STORE** LCD dials to select the custom voice number to which you want to store the newly created custom voice.

Press the **EXECUTE** button, then press **YES** to store the voice when the confirmation display appears (or **NO** to cancel).

**NOTE**

- Custom voices can be saved to or loaded from disk all at once or individually (see pages 140, 141).



### CLEAR CUSTOM VOICE

Clears unwanted custom voices from memory, making more memory available for custom voice storage.

Use the **CLEAR** LCD dials to select the custom voice you want to clear.

Press the **EXECUTE** button, then press **YES** to clear the voice when the confirmation display appears (or **NO** to cancel).

**NOTE**

- The custom voice currently being edited or a custom voice which is currently being used in an element in the E1:WAVEFORM display cannot be cleared.



# The Custom Style Creator

The STYLE CREATOR mode allows you to create original accompaniment styles that can be later recalled and played at any time, just like the presets. PSR-8000 accompaniment styles comply with Yamaha SFF (Style File Format) specifications. Up to 16 custom accompaniment styles can be maintained in internal memory at the same time, and any number can be saved to disk for later reloading and use. 10 sections can be created for each custom style: MAIN A, MAIN B, INTRO A, INTRO B, FILL IN AA, FILL IN BB, FILL IN AB, FILL IN BA, ENDING A and ENDING B.

## Procedure: Custom Style Recording

The basic CUSTOM STYLE CREATOR recording procedure is as follows. Refer to the individual display page descriptions for details.

### 1 Engage the STYLE CREATOR mode. ....

Press the [STYLE CREATOR] button. The currently selected accompaniment style will appear in the ORIGINAL STYLE window on the display.

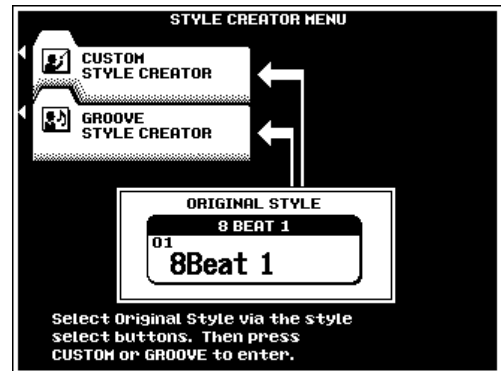
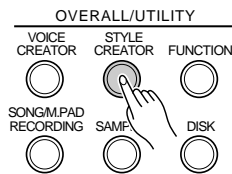

### 2 Select a style, if necessary. ....

Select a preset style or one of the [CUSTOM STYLE] or [GROOVE STYLE] styles that is close to the style you want to create. Style selection is carried out in the normal way (page 28).

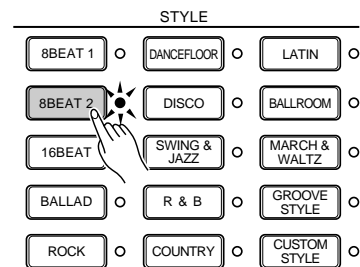

### 3 Engage the CUSTOM STYLE CREATOR. ....

Press the CUSTOM STYLE CREATOR LCD button to go to the CUSTOM STYLE CREATOR display.

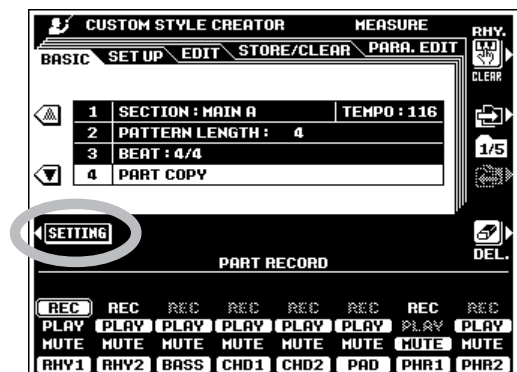

**4** Select the section you want to record, and change the pattern length, time signature, & tempo, as required.....

Perform these operations in the **BASIC** parameter display (page 66). Press the **SETTING** LCD button to access the SECTION, PATTERN LENGTH, BEAT and TEMPO parameters if the PART RECORD parameters are showing.

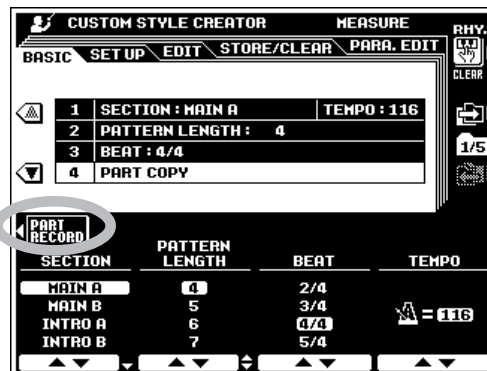

**5** Go to the PART RECORD display and set up the parts.....

Press the **PART RECORD** LCD button to go to the **PART RECORD** display and use the LCD dials to set the REC mode for the part you want to record. Other parts can be play-enabled or muted as required. Parts which contain no data are automatically set to MUTE.

Parts other than RHY1 and RHY2 which contain preset data must be deleted before they can be set to the REC mode (you can overdub over data you've recorded yourself). When the **DEL.** LCD button is pressed **DELETE** will appear for parts which contain data. Select **DELETE** via the part LCD dials while holding the **DEL.** button to delete all data in the corresponding parts. The data is actually deleted when the **DEL.** button is released.

When a part is set to the REC mode the default voice for that part is automatically selected. A different voice may be selected prior to recording by using the usual voice selection method (see "NOTE", to the right)

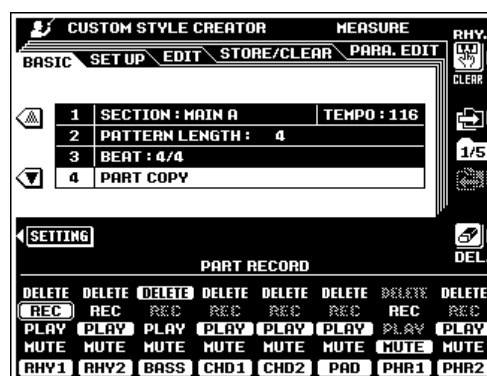

**NOTE**

- Only **DRUM KIT/SFX KIT** and **DRUM KIT** custom voices can be selected for the RHY 1 part.
- All voices except the **ORGAN FLUTE** voice can be selected for the RHY2 part.
- The **ORGANFLUTE**, **DRUMKIT/SFX KIT**, and **DRUM KIT** custom voices cannot be selected for the BASS through PHR2 parts.

**6** Start the record loop.....

Press the **[START/STOP]** button to start recording. The selected section of the current style will begin playing in the key of C major 7 (only the metronome will sound if the entire style has been cleared). The style will loop (play) continuously to allow convenient recording and "overdubbing".

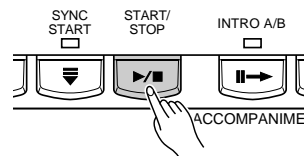

## 7 Record the selected part. ....

You can now add new notes to the selected part by playing the keyboard at the appropriate timing. The default chord for data entry is C major 7. A different chord can be specified as required via the **PARA. EDIT** display page, described on page 71. If both the RHY1 and RHY2 parts are deleted the metronome will sound to provide a timing guide (the metronome sound is not recorded). A single drum instrument can be cleared from the RHY1 or RHY2 part which is currently set to the REC mode by pressing the key corresponding to the instrument to be cleared while holding the **RHY. CLEAR** LCD button.

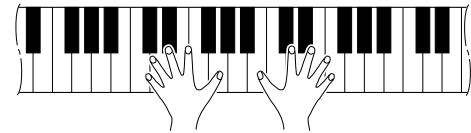

### ● MAIN and FILL Section Rules

Observe the following rules when recording the MAIN and FILL sections:

- Use only the CM7 (or chord specified by the PARA. EDIT page parameters) scale notes when recording the BASS and PHRASE parts.
- Use only the chord notes when recording the CHORD and PAD tracks.
- Refer to the "Source Chord Type List" on page 65 for the scale and chord notes for each source chord type.
- Any appropriate chord or chord progression can be used for the INTRO and ENDING sections.

### NOTE

- Key On/Off, Volume, Pitch Bend and Modulation data, etc., can be recorded.
- Playback can be started and stopped via the [START/STOP] button as required while in the STYLE CREATOR mode — data cannot be recorded while playback is stopped. It is a good idea, however, to use [SYNC START] if you want to record from the top of the first measure.
- The volume, effects, and other parameters related to the voice being used can be adjusted via the FADER or FULL MIXING CONSOLE display R1 part LCD dials. "--" will appear in the value location of parameters which are not available.
- A "KEY OFF" event will automatically be recorded at the end of the loop.
- Try to keep the maximum number of simultaneous notes below 20. Use the POLY COUNTER function (UTILITY F8, page 131) to keep track of the total number of notes being played.

## 8 Repeat until all parts have been recorded. .

Continue selecting the REC mode for the various parts in the **PART RECORD** display and recording them as required until all parts have been recorded.

## 9 Go on to SETUP, EDIT, PARA. EDIT, and STORE. ....

You can now stop the accompaniment by pressing the [START/STOP] button (or leave it running, as required), and go on to the **SETUP** display (page 67), the **EDIT** display (page 68) and/or the **PARA. EDIT** display (page 71). When your custom accompaniment is complete, be sure to use the **STORE** function (page 70), to store the style to one of the CUSTOM STYLE memory locations.

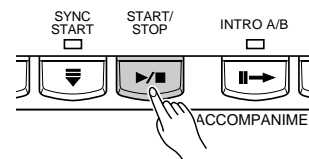

## 10 Exit when done. ....

When your custom accompaniment is stored, press the [STYLE CREATOR] or [EXIT] button to exit from the STYLE CREATOR mode.

### NOTE

- It is also possible to create custom styles using an external sequencer, as described on page 73.

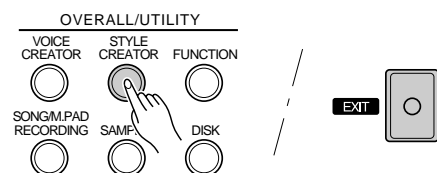



### ● Source Chord Type List



The source chord types which can be used for Custom Style recording are listed below. A “C” on a key indicates a chord/scale note, while an “S” on a key indicates a scale note.

<p><b>CM</b> [Maj]</p>	<p><b>CM6</b> [Maj6]</p>	<p><b>CM7</b> [Maj7]</p>	<p><b>CM7(#11)</b> [M7#11]</p>	<p><b>CM add9</b> [(9)]</p>
<p><b>C7(9)</b> [M7(9)]</p>	<p><b>C6(9)</b> [6(9)]</p>	<p><b>Caug</b> [aug]</p>	<p><b>Cm</b> [min]</p>	<p><b>Cm6</b> [min6]</p>
<p><b>Cm7</b> [min7]</p>	<p><b>Cm7b5</b> [m7b5]</p>	<p><b>Cm(9)</b> [m(9)]</p>	<p><b>Cm7(9)</b> [m7(9)]</p>	<p><b>Cm7(11)</b> [m7_11]</p>
<p><b>CmM7</b> [mM7]</p>	<p><b>CmM7(9)</b> [mM7_9]</p>	<p><b>Cdim</b> [dim]</p>	<p><b>Cdim7</b> [dim7]</p>	<p><b>C7(7th)</b></p>
<p><b>C7sus4</b> [7sus4]</p>	<p><b>C7b5</b> [7b5]</p>	<p><b>C7(9)</b> [7(9)]</p>	<p><b>C7(#11)</b> [7#11]</p>	<p><b>C7(13)</b> [7(13)]</p>
<p><b>C7(b9)</b> [7(b9)]</p>	<p><b>C7(b13)</b> [7b13]</p>	<p><b>C7(#9)</b> [7(#9)]</p>	<p><b>CM7aug</b> [M7aug]</p>	<p><b>C7aug</b> [7aug]</p>
<p><b>C1+8</b> [1+8]</p>	<p><b>C1+5</b> [1+5]</p>	<p><b>Csus4</b> [sus4]</p>	<p><b>C1+2+5</b> [1+2+5]</p>	

## CUSTOM STYLE CREATOR Parameters

The CUSTOM STYLE CREATOR has the following display pages:

<b>BASIC</b> .....	66
<b>SETUP</b> .....	67
<b>EDIT</b> .....	68
<b>STORE/CLEAR</b> .....	70
<b>PARAMETER EDIT</b> .....	71

These pages are selected via the  and  LCD buttons to the right of the display, and the various parameters in each display page can be accessed via the  and  LCD buttons. In all cases the selected parameter can be edited via the appropriately labeled or positioned LCD dials.

Please note that in the CUSTOM STYLE creator the PART RECORD parameters can be accessed from any display page by pressing the **PART RECORD** LCD button. The **SETTINGS** LCD button returns you to the standard parameters for the current page.

### Exiting .....

The **[EXIT]** or **[STYLE CREATOR]** button can be used at any time to exit from a parameter display and return to the **STYLE CREATOR MENU**. Pressing the **[EXIT]** or **[STYLE CREATOR]** button while the **STYLE CREATOR MENU** is showing will return you to the normal play mode.

 **NOTE**

- If you change styles or exit from the CUSTOM STYLE CREATOR mode before storing an edited style, a store confirmation display will appear. Press YES to store the data, NO to exit without storing, or CANCEL to continue editing. The YES button returns you to the STORE/CLEAR display.

## BASIC

### SECTION/PATTERN LENGTH/BEAT/TEMPO .....

Use the **SECTION** LCD dials to select the section you want to program: MAIN A, MAIN B, INTRO A, INTRO B, FILL IN AA, FILL IN BB, FILL IN AB, FILL IN BA, ENDING A and ENDING B.

Use the **PATTERN LENGTH** LCD dials to select a different number of measures for the selected section (except for FILL IN sections, which are fixed at 1 measure). Please note that the number of measures can only be changed if all parts of the current section have been cleared. If any data remains in any part “**All parts must be cleared to set measures. Clear all Parts?**” will appear. Once the parts have been cleared you can select a new number of measures as required: 1 through 32.

Use the **BEAT** LCD dials to select a different time signature: 2/4, 3/4, 4/4, or 5/4. Please note that the time signature can only be changed if all sections of the current custom style have been

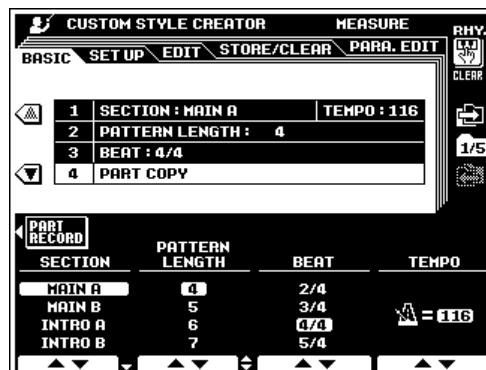

cleared. If any data remains in any section “**All sections must be cleared to set beat. Clear all sections?**” will appear. A new time signature can be selected after pressing the **YES** LCD button.

Use the **TEMPO** LCD dials to set the default tempo for the new style.

**NOTE**

- In addition to the **SECTION** LCD dials, the current section can be switched via the panel section buttons — **INTRO A/B**, **MAIN/AUTO FILL**, **ENDING/rit**. This applies to all other **CUSTOM STYLE** displays, so it is not necessary to return to this display page whenever you want to switch sections.

## PART COPY

Instead of starting with all the sections and/or parts from the selected original style, you can copy specific parts from other sections/parts of the same style, or from other styles as required.

Use the **▼** LCD button to the left of the display to select the **PART COPY** parameters. Then use the **CATEGORY/STYLE** LCD dials to select the style from which you want to copy a part, the **SECTION** LCD dials to select the section you want to copy from, the **PART** LCD dials to select the part you want to copy (“**ALL**” to copy all parts of the selected section at once), and the **DESTINATION** LCD dials to select the part in the currently selected section to which you want to copy the selected part (only “**ALL**” will be available when the **PART** parameters is set to “**ALL**”). Once the source part(s) and destination have been specified, press the **EXECUTE** LCD button to actually copy the part(s).

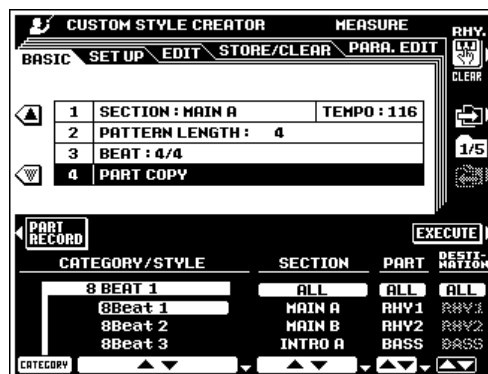

**NOTE**

- Parts can not always be copied from styles which have a different time signature. Also, in some cases it may not be possible to copy from other parts. In such a case the **EXECUTE** LCD button will appear in gray and will not be available.

## SETUP

### VOICE

These parameters assign voices to the parts available in the currently selected section.

Use the **PART** LCD dials to select a part you want to assign a different voice to. “\*” will appear for parts which contain no data and cannot be selected.

Use the **CATEGORY** LCD dials to select a voice category, and the **VOICE** dials to select the specific voice to be assigned to the selected **PART**. Voices which cannot be used will not be displayed.

#### ● Editing Other SETUP Parameters

Other **SETUP** parameters (volume, effects, etc.) can be edited via the **FULL MIXING CONSOLE [ACMP PART]** displays (page 40).

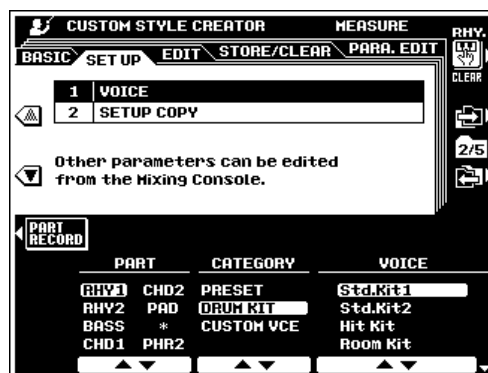

## SETUP COPY

Copies all SETUP parameter settings (VOICE and FULL MIXING CONSOLE ACMP PART settings, etc.) from the SOURCE PART in the currently selected section to the specified DESTINATION SECTION and PART.

The **SOURCE PART** LCD dials select **ALL** to copy from all parts in the currently selected section to all corresponding parts in the destination section, or **CURRENT** to copy from the current record part in the currently selected section to the specified destination section/part.

The **DESTINATION SECTION** LCD dials specify the section to which the SETUP settings will be copied, and the **DESTINATION PART** LCD dials specify the part to which the SETUP settings will be copied if the CURRENT source part is selected.

Press the **EXECUTE** button.

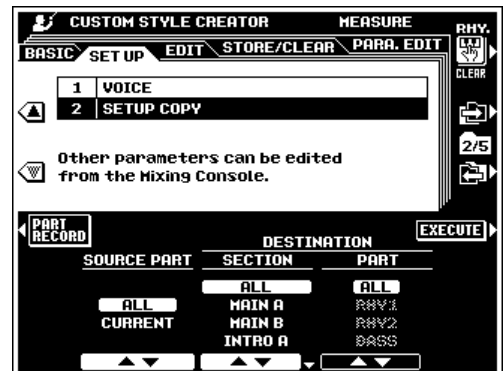

### NOTE

- Copying may not be possible with some source and destination combinations. In such a case the EXECUTE LCD button will appear in gray and will not be available.

## EDIT

For all EDIT functions use the **PART** LCD dials to select the part (in the currently selected section) to be edited. The part name for parts which are being used unedited from a preset style will appear in gray letters. “\*” will appear for parts which contain no data. Neither can be selected for editing. And when all parameters (if any) have been set up as required, press the **EXECUTE** button to execute the corresponding edit operation. “Executing” will appear on the display while the data is being processed. After processing the **EXECUTE** button changes to an **UNDO** button which can be used to undo the operation if the results are not satisfactory. UNDO is only effective until the next operation is performed.

## QUANTIZE

The QUANTIZE function aligns recorded notes to the specified beats to “tighten up” the timing of a performance.

Use the **SIZE** LCD dials to select the beats to which the notes will be aligned.

The **STRENGTH** dials determine how “strongly” the notes will be quantized. If a value less than “100%” is selected, notes will be moved toward the specified quantization beats only by the specified amount.



The quantize sizes are:

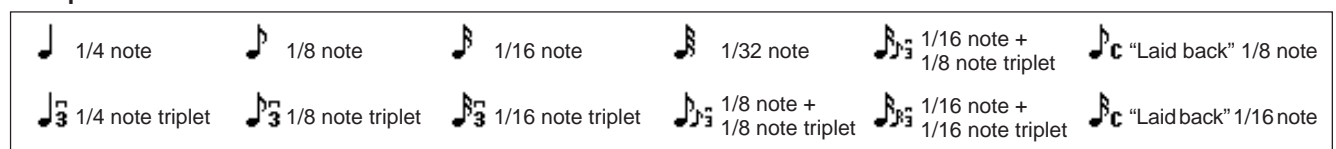

## VELOCITY CHANGE

Boosts or cuts the velocity of all notes in the specified part by the specified percentage.

Use the **BOOST/CUT** LCD dials to specify the percentage by which you want the note velocities to be boosted or cut.



## MEASURE COPY

This function allows data to be copied from one measure or group of measures to another location within the same part.

Use the **TOP** and **LAST** LCD dials to specify the first and last measures in the region to be copied. Use the **DEST** LCD dial to specify the top of the measure to which the data is to be copied.

### NOTE

- If the copy destination falls outside the number of measures actually in the part, the corresponding source measures will not be copied.

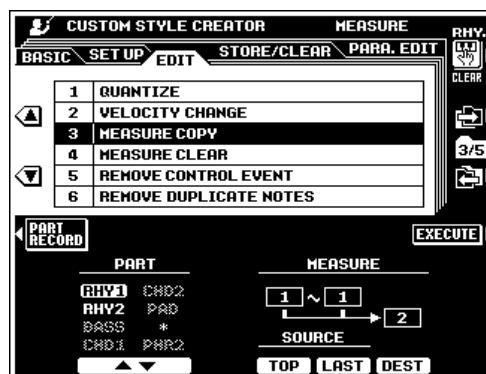

## MEASURE CLEAR

This function clears all data from the specified range of measures within the specified part.

Use the **TOP** and **LAST** LCD dials to specify the first and last measures in the range to be cleared.



## REMOVE CONTROL EVENT

This function can be used to remove all occurrences of a specified type of control event from a specified part.

Use the **EVENT** LCD dials to select the type of event to be removed.

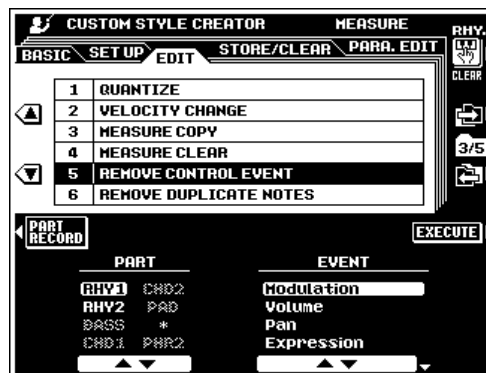

## REMOVE DUPLICATE NOTES .....

Removes all duplicate notes from a specified part.

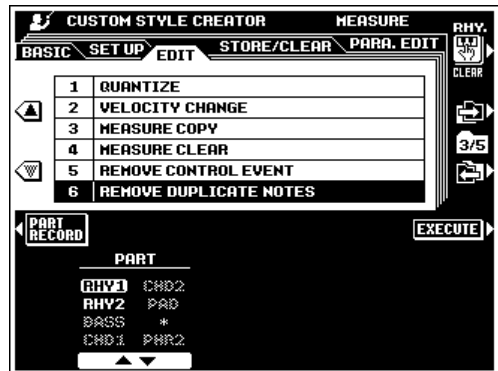

## STORE/CLEAR

### NAME .....

A name can be entered for each custom style, as described on page 21.



### STORE .....

Stores the recorded custom accompaniment data for use with the PSR-8000 accompaniment feature. When this function is selected the size of the current style and the remaining memory capacity available for style storage are displayed to the right of the display. The names and sizes of all other styles currently in memory are shown in the lower section of the display.

Use the **STORE** LCD dials to select the custom style number to which you want to store the newly created custom style.

Press the **EXECUTE** button.



### CLEAR CUSTOM STYLE .....

Clears unwanted custom styles from memory, making more memory available for custom style storage.

Use the **CLEAR** LCD dials to select the custom style you want to clear.

Press the **EXECUTE** button.



- The style currently being recorded or edited cannot be cleared.



## PARAMETER EDIT

The AUTO ACCOMPANIMENT feature works by automatically re-harmonizing the “source pattern” to match the specified chords. This is done on the basis of NTR (Note Transposition Rule) and NTT (Note Transposition Table) settings that, in the PSR-8000, can be individually set for each part and each section.

### PART/SOURCE ROOT/SOURCE CHORD .....

These settings determine the original key of the source pattern (i.e. the key used when recording the pattern). The default, CM7 (the source root is “C” and the source chord type is “M7”), is automatically selected whenever the preset data is deleted prior to recording a new style, regardless of the source root and chord included in the preset data.

Use the **PART** dials to select a part in the currently selected section, then use the **SOURCE ROOT** and **SOURCE CHORD** dials to specify the desired root and chord (these parameters may appear as “**PLAY ROOT**” and “**PLAY CHORD**”. See “NOTE”, below).

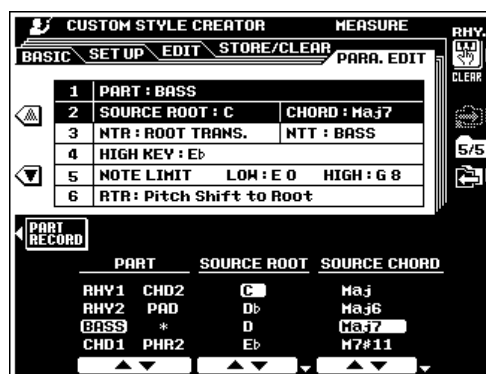

### NTR/NTT .....

The **NTR** dials specify the transposition rule to be used by the transposition table. Two settings are available:

<b>ROOT TRANS.</b>	When transposed the pitch relationship between notes is maintained. For example, the notes C3, E3, and G3 in the key of C will become F3, A3, and C4 when transposed to F. Use this setting for parts that contain melodic lines.
<b>ROOT FIXED</b>	The note is kept as close as possible to the previous note range. For example, the notes C3, E3, and G3 in the key of C will become C3, F3, and A3 when transposed to F. Use this setting for chordal parts.



The **NTT** dials specify the note transposition table to be used for source pattern transposition. 6 table types are available:

<b>BYPASS</b>	No transposition.
<b>MELODY</b>	Suitable for melody line transposition. Use for melody parts such as PHRASE 1 and PHRASE 2.
<b>CHORD</b>	Suitable for chord transposition. Use for the CHORD 1 and CHORD 2 parts when they contain piano or guitar-like chordal parts.
<b>BASS</b>	Suitable for bass line transposition. This table is basically similar to the MELODY table, but recognizes “on-bass” chords allowed in the FINGERED 2 fingering mode. Use primarily for bass lines.

<b>MELODIC MINOR</b>	This table lowers the third scale degree by a semitone when changing from a major to a minor chord, or raises the minor third scale degree a semitone when changing from a minor to a major chord. Other notes are not changed.
<b>HARMONIC MINOR</b>	This table lowers the third and sixth scale degrees by a semitone when changing from a major to a minor chord, or raises the minor third and flatted sixth scale degrees a semitone when changing from a minor to a major chord. Other notes are not changed.

**NOTE**

- When NTR (above) is set to ROOT FIXED and NTT (also above) is set to BYPASS, the SOURCE ROOT and SOURCE CHORD parameter names change to PLAY ROOT and PLAY CHORD. In this case it is possible to change chords and hear how the results sound for all parts.
- If "P" or "PRESET" appears for the SOURCE ROOT, SOURCE CHORD, NTR, or NTT parameter, the preset data uses special settings.

## HIGH KEY/NOTE LIMIT

The **HIGH KEY** dials specify the upper root limit. Chords with a root higher than the specified limit will be played in the octave immediately below the high-key limit. This setting is effective only when the NTR parameter (above) is set to **ROOT TRANS.**

**Example:** When HIGH KEY = F.

Root Motion    C        C#        D        ... F        F#  
Notes Produced C3-E3-G3 C#3-F3-G#3 D3-F#3-A3 ... F3-A3-C4 F#2-A#2-C#3

**NOTE LIMIT LOW** and **HIGH** dials specify the low and high note limits for all notes in the specified part. Notes outside this range are transposed to the nearest octave within the range.

**Example:** When LOW = C3 and HIGH = D4

Root Motion    C        C#        ... D#  
Notes Produced E3-G3-C4 F3-G#3-C#4 ... D#3-G3-A#3



## RTR

The **RTR** (Retrigger Rule) dials specify how notes held through chord changes will be handled. 6 settings are available:

<b>Stop</b>	The note is stopped, and resumes sounding from the next note data.
<b>Pitch Shift</b>	The pitch of the note will bend without attack to match the type of the new chord.
<b>Pitch Shift To Root</b>	The pitch of the note will bend without attack to match the root of the new chord.
<b>Retrigger</b>	The note is retriggered with attack at a new pitch matching the new chord type.
<b>Retrigger To Root</b>	The note is retriggered with attack at a new pitch matching the new chord root.
<b>Note Generator</b>	This setting will only be available if programmed in the original style. A designated note is produced with designated pitch, length, and velocity matching the new chord.

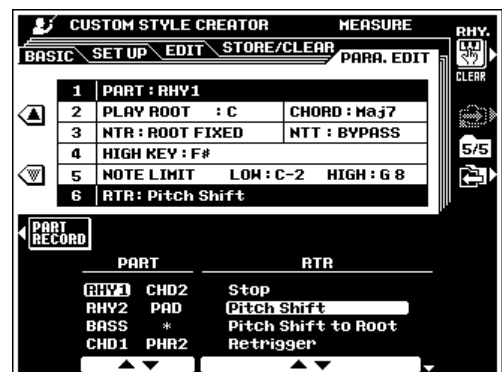



## Custom Style Recording via an External Sequence Recorder

It is possible to create custom styles for the PSR-8000 using an external sequencer (or personal computer with sequencing software) rather than the PSR-8000's STYLE CREATOR function.

### Connections

- Connect the PSR-8000 MIDI OUT to the sequencer MIDI IN, and the sequencer MIDI OUT to the PSR-8000 MIDI IN.
- Make sure that the sequencer "ECHO" function is ON, and the PSR-8000 LOCAL ON/OFF (page 134) is turned OFF.

### Creating the Data

- Record all sections and parts using a CM7 (C major seventh) chord.
- Record the parts on the MIDI channels listed below, using the PSR-8000's internal tone generator. Optimum compatibility with other instruments which are both XG and SFF (Style File Format) compatible can be achieved by using only the XG voices (compatible instruments include the PSR-730/630, and the CVP-98/96/94/92).

Part	MIDI Ch.
Rhythm1	9
Rhythm2	10
Bass	11
Chord1	12
Chord2	13
Pad	14
Phrase1	15
Phrase2	16

- Record the sections in the order listed below, with a Marker Meta-event at the top of each section. Enter the Marker Meta-events exactly as shown (including upper/lower case characters and spaces).
- Also include an "SFF1" Marker Meta-event, "SInt" Marker Meta-event and style name Meta-event at 1|1|000 (the top of the sequence track), and the GM on Sys/Ex message (F0, 7E, 7F, 09, 01, F7). ("Timing" in the chart is based on 480 clocks per quarter note. "1|1|000" is clock "0" of the first beat of the first measure).
- The data from 1|1|000 through 1|4|479 is the "Initial Setup", and 2|1|000 through the end of Ending B is the "Source Pattern".
- The timing of the Fill In AA and subsequent Marker Meta-events will depend on the length of each section.

Timing	Marker Meta-Event	Contents
1 1 000 1 1 000	SFF1	Style Name (Sequence/Track Name Meta-Event)
1 1 000 1 1 000 1 2 000 : 1 4 479	SInt	GM on Sys/Ex  Initial Setup Events
2 1 000 : 3 4 479	Main A	2 bars Main pattern (up to 255 bars)
4 1 000 : 4 4 479	Fill In AA	1 bar Fill In pattern
5 1 000 : 5 4 479	Fill In AB	1 bar Fill In pattern
6 1 000 : 7 4 479	Intro A	2 bars Intro pattern (up to 255 bars)
8 1 000 : 9 4 479	Ending A	2 bars Ending pattern (up to 255 bars)
10 1 000 : 11 4 479	Main B	2 bars Main pattern (up to 255 bars)
12 1 000 : 12 4 479	Fill In BA	1 bar Fill In pattern
13 1 000 : 13 4 479	Fill In BB	1 bar Fill In pattern
14 1 000 : 15 4 479	Intro B	2 bars Intro pattern (up to 255 bars)
16 1 000 : 17 4 479	Ending B	2 bars Ending pattern (up to 255 bars)

Initial Setup

Source Pattern

A template which is handy for creating style data is included on the supplied floppy disk (TEMPLATE.MID).

- The Initial Setup area from 1|2|000 through 1|4|479 is used for voice and effect settings. Do not include note event data.
- The Main A data begins at 2|1|000. Any number of measures from 1 to 255 can be used. All measures must have one of the following time signatures: 2/4, 3/4, 4/4, or 5/4.
- Fill In AA begins from the top of the measure following the last measure of the Main A pattern. In the chart this is 4|1|00, but this is only an example and the actual timing will depend on the length of Main A. Please note that all Fill Ins can be only 1 measure in length (refer to the Section Length chart, below).

Section	Length
Intro	255 measures max.
Main	255 measures max.
Fill In	1 measure
Ending	255 measures max.

- The following MIDI events can be included in the Initial Setup and Source Pattern. Do not include any events which are not marked "OK", or events not listed in the chart.

### Channel Message

Event	Initial Setup	Source Pattern
Note Off		OK
Note On		OK
Program Change	OK	OK
Pitch Bend	OK	OK
Control#0 (Bank Select MSB)	OK	OK
Control#1 (Modulation)	OK	OK
Control#6 (Data Entry MSB)	OK	
Control#7 (Master Volume)	OK	OK
Control#10 (Panpot)	OK	OK
Control#11 (Expression)	OK	OK
Control#32 (Bank Select LSB)	OK	OK
Control#38 (Data Entry LSB)	OK	
Control#71 (Harmonic Content)	OK	OK
Control#72 (Release Time)	OK	
Control#73 (Attack Time)	OK	
Control#74 (Brightness)	OK	OK
Control#84 (Portamento Control)		OK
Control#91 (Reverb Send Level)	OK	OK
Control#93 (Chorus Send Level)	OK	OK
Control#94 (Variation Send Level)	OK	OK
Control#98 (NRPN LSB)	OK	
Control#99 (NRPN MSB)	OK	
Control#100 (RPN LSB)	OK	
Control#101 (RPN MSB)	OK	

### RPN & NRPN

Event	Initial Setup	Source Pattern
RPN (Pitch Bend Sensitivity)	OK	
RPN (Fine Tuning)	OK	
RPN (Null)	OK	
NRPN (Vibrato Rate)	OK	
NRPN (Vibrato Delay)	OK	
NRPN (EG Decay Time)	OK	
NRPN (Drum Filter Cut Off Frequency)	OK	
NRPN (Drum Filter Resonance)	OK	
NRPN (Drum EG Attack Time)	OK	
NRPN (Drum EG Decay Time)	OK	
NRPN (Drum Instrument Pitch Coarse)	OK	
NRPN (Drum Instrument Pitch Fine)	OK	
NRPN (Drum Instrument Level)	OK	
NRPN (Drum Instrument Panpot)	OK	
NRPN (Drum Instrument Reverb Send Level)	OK	
NRPN (Drum Instrument Chorus Send Level)	OK	
NRPN (Drum Instrument Variation Send Level)	OK	

### System Exclusive

Event	Initial Setup	Source Pattern
Sys/Ex GM on	OK	
Sys/Ex XG on	OK	
Sys Ex XG Parameter Change (Effect1)	OK	
Sys Ex XG Parameter Change (Multi Part)		
PART MODE	OK	
DRY LEVEL	OK	OK
Sys Ex XG Parameter Change (Drum Setup)		
PITCH COARSE	OK	
PITCH FINE	OK	
LEVEL	OK	
PAN	OK	
REVERB SEND	OK	
CHORUS SEND	OK	
VARIATION SEND	OK	
FILTER CUTOFF FREQUENCY	OK	
FILTER RESONANCE	OK	
EG ATTACK	OK	
EG DECAY1	OK	
EG DECAY2	OK	

## ■ Saving and Loading the Sequence Data .....

- Save the completed sequence data to a 2DD or 2HD DOS format floppy disk (or use a disk formatted by the PSR-8000).
- Use a file name consisting of no more than 8 characters, and add a ".STY" suffix.
- Save the file using Standard MIDI File Format 0.
- Insert the disk into the PSR-8000 floppy drive, and load the file as a custom style (page 140).
- If the file won't load properly, check the following:
  - Is the file name correct (up to 8 characters + .STY)?
  - Is "SFF1" properly recorded at 1|1|000?
  - Is the GM on Sys/Ex properly recorded at 1|1|000?

## ■ Refining the Style .....

- Once the new style has been loaded, use the PSR-8000 STYLE CREATOR to refine it as required.
- Set up the NOTE LIMIT, NTT, and NTR parameters to ensure that the style plays properly with the widest possible range of chords.
- Set the RTR parameter for the smoothest chord changes.  
If any changes need to be made to the sequence data itself, use the sequencer to make the changes then reload the data into the PSR-8000.

# The Groove Style Creator

The GROOVE STYLE CREATOR mode allows you to modify the timing, velocity, and other parameters of the preset styles to create original “groove” styles that can be later recalled and played at any time, just like the presets. Up to 20 groove styles can be maintained in internal memory at the same time, and any number can be saved to disk for later reloading and use.

## Procedure: Creating a Groove Style

The basic GROOVE STYLE CREATOR recording procedure is as follows. Refer to the individual display page descriptions for details.

### 1 Engage the STYLE CREATOR mode. ....

Press the [STYLE CREATOR] button. The currently selected accompaniment style will appear in the **ORIGINAL STYLE** window on the display.

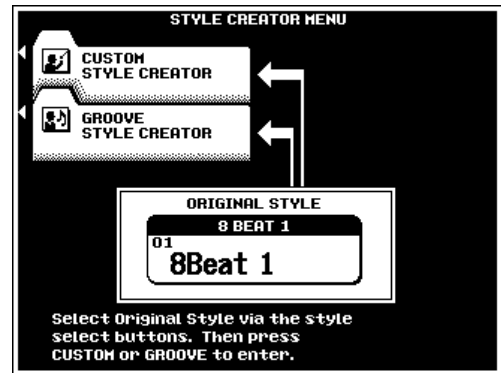
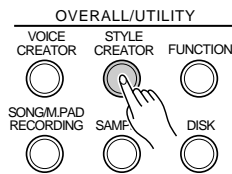

### 2 Select a style, if necessary. ....

Select a preset style or one of the [CUSTOM STYLE] or [GROOVE STYLE] styles that you want to modify. Style selection is carried out in the normal way (page 28).

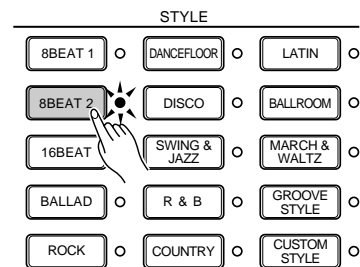

### 3 Engage the GROOVE STYLE CREATOR. ....

Press the **GROOVE STYLE CREATOR** LCD button to go to the **GROOVE STYLE CREATOR** display.

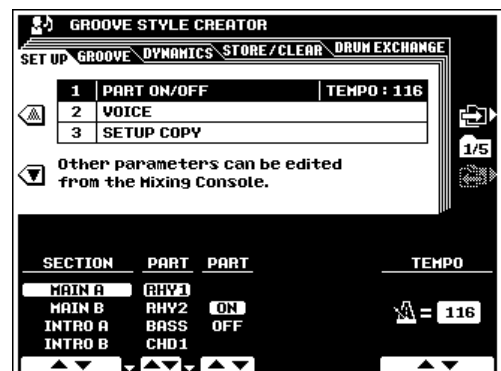

## 4 Start playback.

Press the [START/STOP] button to start playback of the selected style (be sure to use AUTO ACCOMPANIMENT and play a chord in the auto accompaniment section of the keyboard in order to hear all parts of the style). The style will loop (play) continuously.

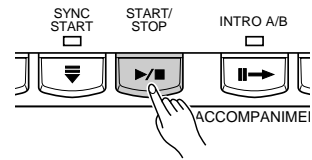

## 5 Modify the style as required.

Use the parameters in the **SETUP**, **GROOVE**, **DYNAMICS**, and **DRUM EXCHANGE** display pages to modify the style as required (see the “GROOVE STYLE CREATOR Parameters” section, below).

## 6 Store the style.

When your groove style is complete, be sure to use the STORE function (page 80), to store the style to one of the GROOVE STYLE memory locations.

## 7 Exit when done.

When your groove style is complete, press the [STYLE CREATOR] or [EXIT] button to exit from the STYLE CREATOR mode.

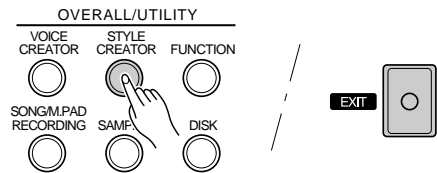

## GROOVE STYLE CREATOR Parameters

The GROOVE STYLE CREATOR has the following display pages:

<b>SETUP</b> .....	78
<b>GROOVE</b> .....	79
<b>DYNAMICS</b> .....	80
<b>STORE/CLEAR</b> .....	80
<b>DRUM EXCHANGE</b> .....	82

These pages are selected via the and LCD buttons to the right of the display, and the various parameters in each display page can be accessed via the and LCD buttons. In all cases the selected parameter can be edited via the appropriately labeled or positioned LCD dials.

## Exiting

The [EXIT] or [STYLE CREATOR] button can be used at any time to exit from a parameter display and return to the **STYLE CREATOR MENU**. Pressing the [EXIT] or [STYLE CREATOR] button while the STYLE CREATOR MENU is showing will return you to the normal play mode.

### NOTE

- If you change styles or exit from the GROOVE STYLE CREATOR mode before storing an edited style, a store confirmation display will appear. Press YES to store the data, NO to exit without storing, or CANCEL to continue editing. The YES button returns you to the STORE/CLEAR display.

## SETUP

### PART ON/OFF/TEMPO

Turns the specified part in the specified section ON or OFF. Use the **SECTION** LCD dials to select the section: MAIN A, MAIN B, INTRO A, INTRO B, FILL IN AA, FILL IN BB, FILL IN AB, FILL IN BA, ENDING A and ENDING B. Then use the **PART** LCD dials to select the part and turn the selected part ON or OFF.

Use the **TEMPO** LCD dials to set the default tempo for the new style.

**NOTE**

- In addition to the **SECTION** LCD dials, the current section can be switched via the panel section buttons — INTRO A/B, MAIN/AUTO FILL, ENDING/rit. This applies to all other GROOVE STYLE displays.



### VOICE

These parameters assign voices to the specified section/part.

Use the **SECTION** and **PART** LCD dials to select a section/part you want to assign a different voice to.

Use the **CATEGORY** LCD dials to select a voice category, and the **VOICE** dials to select the specific voice to be assigned to the selected PART. Voices which can not be used are not displayed.

#### ● Editing Other SETUP Parameters

Other SETUP parameters (volume, effects, etc.) can be edited via the FULL MIXING CONSOLE [ACMP PART] displays (page 40).



### SETUP COPY

Copies all SETUP parameter settings (VOICE and FULL MIXING CONSOLE ACMP PART settings, etc.) from the SOURCE SECTION and PART to the specified DESTINATION SECTION and PART.

Use the **SOURCE SECTION**, **SOURCE PART**, **DESTINATION SECTION**, and **DESTINATION PART** LCD dials to specify the source and destination sections and parts as required.

Press the **EXECUTE** button.

**NOTE**

- Copying may not be possible with some source and destination part combinations. In such a case the EXECUTE LCD button will appear in gray and will not be available.



## GROOVE

### GROOVE

The parameters in this display are used to change the timing of the style to create the required “groove”.

Use the **SECTION** LCD dials to select the section you want to apply groove timing to.

The **BEAT** dial specifies the beats to which groove timing is to be applied (i.e. if “8” is selected groove timing is applied to 8th notes in the selected section, or if “12” is selected groove timing is applied to 8th-note triplets).

The **BEAT CONVERTER** dials actually change the timing of the beats specified by the **BEAT** dial to the specified value. The available **BEAT CONVERTER** settings change according to the selected **BEAT**. With a **BEAT** setting of “8” and a **BEAT CONVERTER** setting of “12”, for example, all 8th notes in the section are shifted to 8th-note triplet timing. The “16A” and “16B” **BEAT CONVERTER** settings which appear when **BEAT** is set to “12” are variations of the “16” setting.

The **SWING** dial produces a “swing” feel by shifting the timing of “back beats”, as specified by the **BEAT** parameter. For example, if the specified **BEAT** value is 8th notes, then the swing parameter will delay the 2nd, 4th, 6th, and 8th beats of each measure to create a swing feel. The “A” through “E” settings produce different degrees of swing feel, with “A” being the most subtle and “E” being the strongest.

The **FINE** dials select a range of “groove templates” to be applied to the current section. “PUSH” settings cause certain beats to be played early, while “HEAVY” settings delay the timing of certain beats. The number — “2”, “3”, “4”, or “5” — determines which beats are to be affected. All beats up to the specified beat, but not including the first beat, will be played early or delayed: e.g. the 2nd and 3rd beats if “3” is selected. In all cases “A” types produce minimum effect, “B” types produce medium effect, and “C” types produce the maximum effect.

Press the **PRESET** LCD button to restore the default settings for the current style.

### SETUP COPY

Copies all GROOVE parameter settings from the **SOURCE SECTION** to the specified **DESTINATION SECTION**.

The **SOURCE SECTION** LCD dials select the section you want to copy from.

The **DESTINATION SECTION** LCD dials specify the section to which the GROOVE settings will be copied.

Press the **EXECUTE** button.

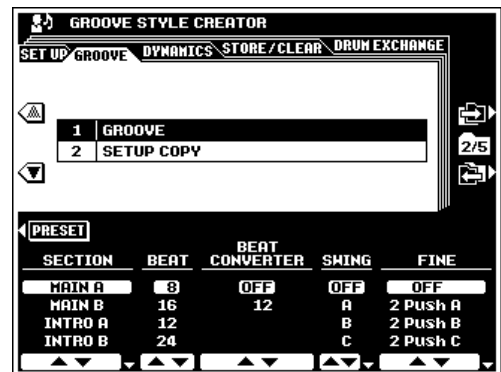

#### NOTE

- When a groove setting is changed while the style is playing, the changes will take effect from the top of the next measure.

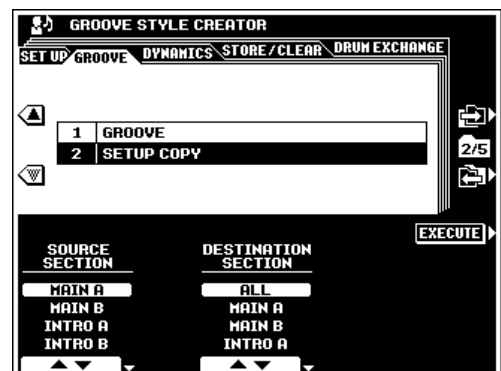

## DYNAMICS

### DYNAMICS

The parameters in this display are used to change the velocity of certain notes to complement the required “groove” feel.

Use the **SECTION** LCD dials to select the section containing the part you want to apply groove dynamics to, and the **PART** dial to select the specific part.

The **ACCENT TYPE** LCD dials select the type of accent template to be applied to the selected section/part.

The **STRENGTH** dial determines how “strongly” the selected ACCENT TYPE will be applied. Higher values produce a stronger effect.

The **EXPAND/COMP.** dial expands or compresses the range of velocity values in the selected section, based on a “central” velocity value of “64”. Values higher than 100% expand the dynamic range, and values lower than 100% compress the dynamic range.

The **BOOST/CUT** dial boosts or cuts all velocity values in the selected section/part. Values above 100% boost the overall velocity and values below 100% reduce the overall velocity.

Press the **PRESET** LCD button to restore the default settings for the current style.

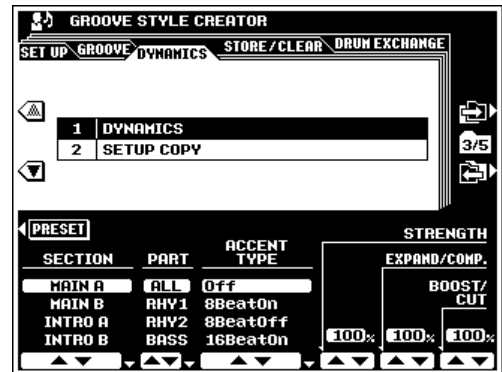

### SETUP COPY

Copies all DYNAMICS parameter settings from the SOURCE SECTION and PART to the specified DESTINATION SECTION and PART.

Use the **SOURCE SECTION**, **SOURCE PART**, **DESTINATION SECTION**, and **DESTINATION PART** LCD dials to specify the source and destination sections and parts as required.

Press the **EXECUTE** button.



## STORE/CLEAR

### NAME

A name can be entered for each groove style as described on page 21.





## STORE

Stores the recorded groove style data for use with the PSR-8000 accompaniment feature. When this function is selected the size of the current groove style (groove data only) and the remaining memory capacity available for style storage are displayed to the right of the display. The names and sizes of all other groove styles currently in memory are shown in the lower section of the display.

Use the **STORE** LCD dials to select the groove style number to which you want to store the newly created groove style.

Press the **EXECUTE** button.



## GROOVE STYLE CLEAR

Clears unwanted groove styles from memory, making more memory available for groove style storage.

Use the **GROOVE STYLE CLEAR** LCD dials to select the groove style you want to clear.

Press the **EXECUTE** button.

### NOTE

- The style currently being edited can be cleared unless it was originally a custom style.



## STORE AS CUSTOM STYLE

This function stores the recorded groove style data as a CUSTOM STYLE rather than a GROOVE STYLE. When this function is selected the total size of the current style and the remaining memory capacity available for style storage are displayed to the right of the display. The names and sizes of all other styles currently in memory are shown in the lower section of the display.

Use the **STORE AS CUSTOM STYLE** LCD dials to select the custom style number to which you want to store the newly created groove style.

Press the **EXECUTE** button.



## CUSTOM STYLE CLEAR

Clears unwanted custom styles from memory, making more memory available for custom style storage.

Use the **CUSTOM STYLE CLEAR** LCD dials to select the custom style you want to clear.

Press the **EXECUTE** button.



## DRUM EXCHANGE

### DRUM EXCHANGE

Changes the specified original drum instrument in the RHY1 or RHY2 part to the specified exchange instrument.

Use the **PART** dial to select the RHY1 or RHY2 part for drum exchange. This applies to all sections.

The **ORIGINAL INSTRUMENT** dials specify the drum instrument you want to change, and the **EXCHANGE to** dials specify the drum instrument that will be used in place of the original instrument.

The **BOOST/CUT** dial boosts or cuts all velocity values for the original drum instrument. Values above 100% boost the velocity and values below 100% reduce the velocity.

Press the **PRESET** LCD button to restore the default settings for the current style.

The **SOLO** LCD button lets you “solo monitor” the selected instrument in the selected rhythm part. Press **SOLO** a second time to disengage solo monitoring.

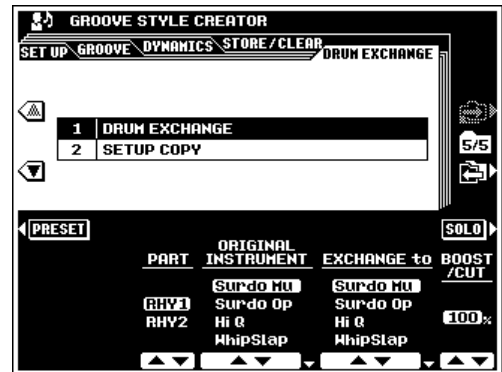

### SETUP COPY

Copies all DRUM EXCHANGE settings from the RHY1 part to the RHY2 part, or vice versa.

Use the **SOURCE to DESTINATION** dials to specify copying from RHY1 to RHY2, or from RHY2 to RHY1.

Press the **EXECUTE** button.

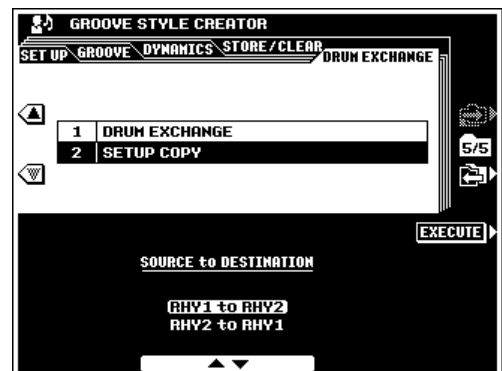

# Vocal Harmony

This unique feature incorporates advanced voice-processing technology to automatically produce vocal harmony based on a single lead vocal. An extensive selection of preset VOCAL HARMONY “types” are provided, each functioning in one of four main “modes” which determine how the harmony notes are applied. In addition to straightforward harmony, the PSR-8000 VOCAL HARMONY feature can change the pitch and timbre of the harmony and/or lead vocal sound to effectively change the apparent gender of the voice. So, for example, if you are a male singer you can have a two-part female vocal backup (the VOCAL HARMONY feature can add up to two harmony notes to the main lead voice). A full range of parameters is provided to allow detailed editing to produce precisely the type of vocal harmony sound you need.

**NOTE**

- Sources other than a single human voice may not produce the expected effect.

## Using Vocal Harmony

### Setting Up

In order to use the VOCAL HARMONY feature, a microphone must be plugged into the PSR-8000 **MIC/LINE IN** jack and the **MIC/LINE** and **INPUT VOLUME** controls set appropriately. This procedure is the same as for connecting and setting up a microphone for sampling — see “Setting Up for Sampling” on page 89.

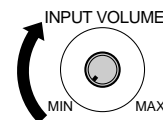
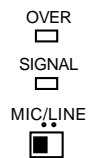
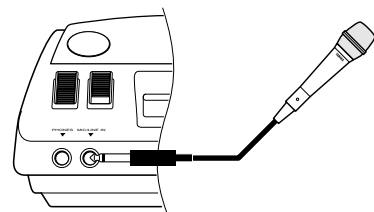

**NOTE**

- Turn the **INPUT VOLUME** control all the way down when connecting or disconnecting a microphone.
- Placing a microphone which is connected to the PSR-8000 too close to the PSR-8000 speakers (or those of an external sound system connected to the PSR-8000) can cause feedback. Adjust the microphone position, and the **MIXING CONSOLE MIC** volume level or **MASTER VOLUME** control level if necessary, so that feedback does not occur.

### The VOCAL/SAMPLING Buttons

The **VOCAL/SAMPLING** buttons all affect the microphone (or line) sound. The **[VOCAL HARMONY(8)]** button is used to turn the VOCAL HARMONY feature on or off. The **[HARMONY VARIATION]** button turns the VOCAL HARMONY variation parameter specified in the **FULL MIXING CONSOLE EFFECT PARAMETER** display on or off.

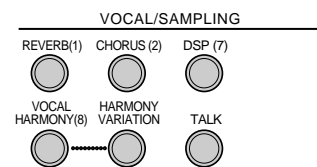

<b>REVERB(1)</b>	Turns the REVERB effect (DSP 1) on or off for the microphone sound.
<b>CHORUS(2)</b>	Turns the CHORUS effect (DSP 2) on or off for the microphone sound.
<b>DSP(7)</b>	Turns the DSP effect (DSP 7) on or off for the microphone sound.
<b>VOCAL HARMONY(8)</b>	Turns the VOCAL HARMONY effect on or off.
<b>HARMONY VARIATION</b>	Turns the VOCAL HARMONY effect variation on or off.
<b>TALK</b>	Engages or disengages the FUNCTION mode F7: TALK SETTINGS for the microphone sound (page 130). The TALK settings only take effect while the TALK button is on.

## Selecting a VOCAL HARMONY Type .....

The VOCAL HARMONY types are selected via the FULL MIXING CONSOLE EFFECT TYPE display in the same way as the other PSR-8000 effects — see page 42 for details.



## Producing the VOCAL HARMONY Effect .....

The vocal harmony effect will be added to your voice. Depending on the selected VOCAL HARMONY type, you may also have to use the AUTO ACCOMPANIMENT feature and/or play the PSR-8000 keyboard to produce appropriate harmony (see “The Vocal Harmony Modes”, page 85).

### ● Using Music Software With a Vocal Harmony Track

When using commercially available software which includes a Vocal HarmonyL track, press the [SONG SELECT] button to go to the SONG SELECT display and use the VOCAL HARM. LCD dial to specify the Vocal Harmony track. Then go to the FULL MIXING CONSOLE EFFECT TYPE display by pressing the [VOCAL HARMONY (8)] button while holding the [DIRECT ACCESS] button, and select one of the “Karaoke\*\*\*\*” VOCAL HARMONY types. (When using an XG song which includes a Vocal Harmony track, the appropriate settings will be made automatically when the song is selected.)

## Editing the Vocal Harmony Parameters

The VOCAL HARMONY effect has a range of parameters which can be edited to customize the sound to suit your individual needs. The parameters are accessed via the FULL MIXING CONSOLE EFFECT PARAMETER display as described on page 42.

The effect USER SET function makes it possible to save up to 3 effect setups for the VOCAL HARMONY feature — details on page 43.

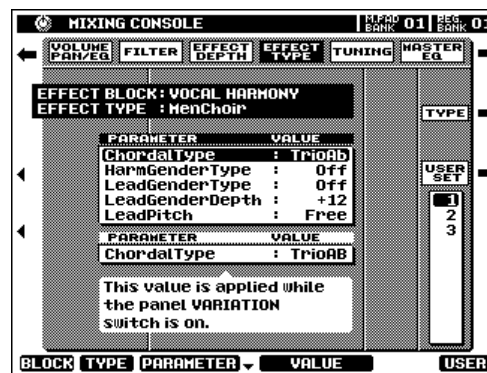

### The Vocal Harmony Parameters

<b>Type</b>	Determines how the harmony notes are applied. The Types are divided into four categories or “modes”: Chordal, Vocoder, Detune, and Chromatic — see “The Vocal Harmony Modes”, below, for details. The available values will depend on the mode to which the selected Type belongs.
<b>Harmony Gender Type</b>	Can be set to “Off” or “Auto”. When “Auto”, the gender of the harmony sound is changed automatically.
<b>Lead Gender Type</b>	Determines whether and how the gender of the lead vocal sound (i.e. the direct microphone sound) will be changed. When “Off” no gender change occurs. When “Unison”, “Male” or “Female” is selected the corresponding gender change is applied to the lead vocal (in this case the number of harmony notes which can be produced in addition to the lead vocal is reduced to one).

<b>Lead Gender Depth</b>	Adjusts the degree of lead vocal gender change produced when one of the Lead Gender Types (above) is selected.
<b>Lead Pitch Correction</b>	When “Correct” is selected the pitch of the lead vocal is shifted in precise semitone increments. This parameter is only effective when one of the Lead Gender Types is selected.
<b>Auto Upper Gender Threshold</b>	Gender change will occur when the harmony pitch reaches or exceeds the specified number of semitones above the lead vocal pitch.
<b>Auto Lower Gender Threshold</b>	Gender change will occur when the harmony pitch reaches or exceeds the specified number of semitones below the lead vocal pitch.
<b>Upper Gender Depth</b>	Adjusts the degree of gender change applied to harmony notes higher than the Auto Upper Gender Threshold.
<b>Lower Gender Depth</b>	Adjusts the degree of gender change applied to harmony notes lower than the Auto Lower Gender Threshold.
<b>Lead/Harmony Balance</b>	Sets the balance between the lead vocal and harmony.
<b>Vibrato Depth</b>	Sets the depth of vibrato applied to the harmony sound. Also affects the lead vocal sound if a Lead Gender Type is selected.
<b>Vibrato Rate</b>	Sets the speed of the vibrato effect.
<b>Vibrato Delay</b>	Specifies the length of the delay before the vibrato effect begins when a note is produced.
<b>Harmony1 Volume</b>	Sets the volume of the first harmony note.
<b>Harmony2 Volume</b>	Sets the volume of the second harmony note.
<b>Harmony1 Pan</b>	Specifies the stereo (pan) position of the first harmony note. When “Random” is selected the stereo position of the sound will change randomly whenever the keyboard is played.
<b>Harmony2 Pan</b>	Specifies the stereo (pan) position of the second harmony note. When “Random” is selected the stereo position of the sound will change randomly whenever the keyboard is played.
<b>Harmony1 Detune</b>	Detunes the first harmony note by the specified number of cents.
<b>Harmony2 Detune</b>	Detunes the second harmony note by the specified number of cents.
<b>Harmony Part</b>	This parameter only appears when a Vocoder Type is selected. When “Upper” or “Lower” is selected, notes played on the corresponding section of the keyboard specify the Vocoder harmony notes.
<b>Pitch to Note</b>	When “ON” the lead vocal sound “plays” the PSR-8000 tone generator system (dynamics, however, are not applied).
<b>Pitch to Note Part</b>	Determines which of the PSR-8000 parts will be controlled by the lead vocal when the Pitch to Note parameter is “ON”.
<b>Harmony Reverb Depth</b>	Sets the depth of the reverb effect for the harmony sound.
<b>Harmony Chorus Depth</b>	Sets the depth of the chorus effect for the harmony sound.

## The Vocal Harmony Modes .....

All of the VOCAL HARMONY Types fall into one of four basic categories — “modes” — which produce harmony in different ways. The mode of the selected Type also determines the values available for the Type parameter in the **EFFECT TYPE PARAMETER** display. Depending on the mode of the selected Type, the Type parameter name will appear on the display as “**Chordal Type**”, “**VocoderType**”, “**DetuneType**”, or “**ChromaticType**”.

## ● Chordal

The pitch of the harmony notes is automatically determined on the basis of the Auto Accompaniment chords.

### “ChordalType” Parameter Settings

Type Name	LCD abbreviation	Harmony 1	Harmony2 (none when Lead Gender on)
DuetAbove	DuetAb	Above lead	- -
DuetBelow	DuetBl	Below Lead	- -
DuetAbove+Bass	DuetAB	Bass	Above lead
TrioAbove	TrioAb	Above lead	Above lead
TrioAbove&Below	TrioAB	Below lead	Above lead
TrioBelow	TrioBl	Below lead	Below lead
DuetAbove+OctaveAbove	DuetAO	Above lead	Above lead
DuetBelow+Bass	DuetBB	Bass	Below lead
DuetBelow+OctaveBelow	DuetBO	Below lead	Below lead
DiatonicAbove	DiaAbv	Above lead	Above lead
DiatonicAbove&Below	DiaAB	Below lead	Above lead
DiatonicBelow	DiaBlw	Below lead	Below lead
JazzAbove	JazzAb	Above lead	Above lead
JazzAbove&Below	JazzAB	Below lead	Above lead
JazzBelow	JazzBl	Below lead	Below lead
Unison	Unison	Unison	- -
3Unison	3Unsn	Unison	Unison
Unison+OctaveAbove	UnsnOA	Unison	Above lead
Unison+OctaveBelow	UnsnOB	Below lead	Unison

## ● Vocoder

When a Vocoder Type is selected, the pitch of the harmony notes is directly controlled via the PSR-8000 keyboard or a Vocal Harmony Track included in a song.

### “VocoderType” Parameter Settings

Type Name	LCD abbreviation	Harmony 1, 2 Shift (no harmony 2 when Lead Gender is on)
No transpose	Otrns	Harmony notes used as is.
Auto transpose	Auto	Harmony notes shifted within an octave of the lead vocal pitch.
-3 ... +3 octave transpose	-3trns ... +3trns	Harmony shifted by the specified number of octaves.

#### NOTE

- The VOCAL HARM. LCD dials in the SONG mode SONG SELECT display (page 102) specify the song track from which the VOCAL HARMONY Vocoder type note data is to be derived. The specified track's volume, pan, detune, modulation, and pitch bend settings will also affect the harmony notes for any VOCAL HARMONY type.

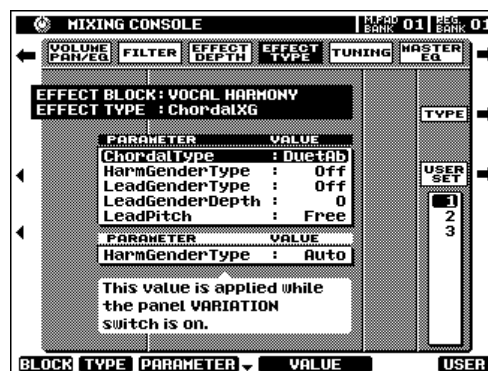

#### NOTE

- The CHORD DETECT LCD dial in the SONG SELECT display (page 102) specifies the song track which will be used for chord detection by the VOCAL HARMONY Chordal type effects. When set to “OFF” the Chordal effects will not function during the song mode. When “XF” is selected chord data is derived from chord meta-events in an XF song file.

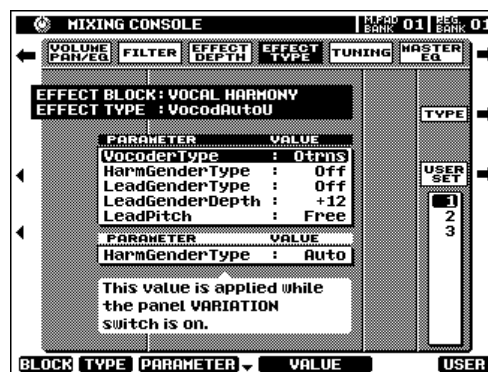

- Received MIDI note data can also be used to specify the Vocoder mode harmony notes when the MIDI receive mode is set to “VOCAL HARMONY” (page 136). The volume, pan, detune, modulation, and pitch bend of any Vocal Harmony type can be adjusted via control change or pitch bend data.
- The Vocal Harmony song track and the Vocal Harmony MIDI channel, described above, are always linked: e.g. if the song track is changed to 3, MIDI receive channel 3 will automatically be set to the VOCAL HARMONY mode, and vice versa.
- With a Vocoder mode type it is possible to produce an “a capella” vocal chorus effect by turning the volume of the panel voices all the way down.

## ● Detune

Detune Types add vocal notes which are detuned by a specific amount, thus adding a chorus effect to the lead voice.

### “DetuneType” Parameter Settings

Type Name	LCD abbreviation	Harmony 1 Pitch Shift	Harmony 2 Pitch Shift (none when Lead Gender on)
TrioLow	TrioLo	-7 cents	+7 cents
TrioMid-Low	TrioML	-11 cents	+11 cents
TrioMid-High	TrioMH	-15 cents	+15 cents
TrioHigh	TrioHi	-20 cents	+20 cents
DuetLow	DuetLo	-7 cents	--
DuetMid-Low	DuetML	-11 cents	--
DuetMid-High	DuetMH	-15 cents	--
DuetHigh	DuetHi	-20 cents	--

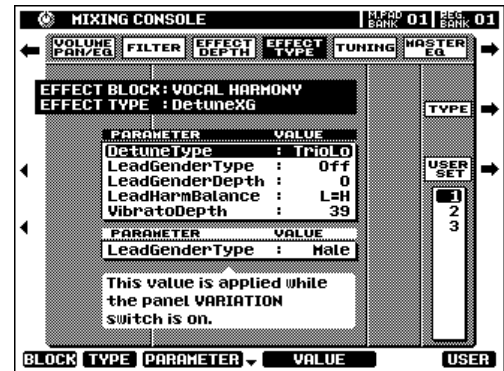

## ● Chromatic

In this mode the harmony notes are always produced at the specified interval from the lead vocal.

### “ChromaticType” Parameter Settings

Type Name	LCD abbreviation	Harmony 1 Pitch	Harmony 2 Pitch (none when Lead Gender on)
OctaveBelow	OctBlw	1 octave down	--
3rdBelow	3rdBlw	Minor 6th down	--
5thBelow	5thBlw	Perfect 4th down	--
Unison	Unison	Unison	--
3rdAbove	3rdAbv	Major 3rd up	--
5thAbove	5thAbv	Perfect 5th up	--
OctaveAbove	OctAbv	1 octave up	--
GregorianI	GregI	1 octave down	Perfect 4th down
GregorianII	GregII	1 octave down	Perfect 4th up
Unison+OctaveAbove	UnsnOA	Unison	1 octave up
Unison+OctaveBelow	UnsnOB	1 octave down	Unison

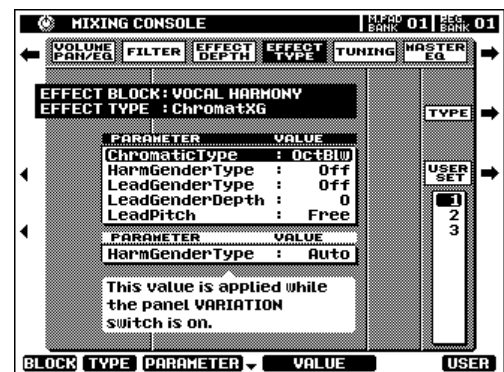

# Sampling

The PSR-8000 SAMPLING feature lets you “sample” sounds via a microphone or line source which can be saved as “waves” within “waveforms” to be used in original custom voices (see “PSR-8000 Waves & Waveforms”, below). The SAMPLING mode also includes a range of wave and waveform editing features which can be used to “fine tune” your samples for optimum sound.

During use sampled sounds are kept in the internal wave RAM memory. The PSR-8000 comes with a 1-megabyte wave memory which can be expanded up to a maximum of 33 megabytes by installing optional SIMM memory modules — see page 152 for details. Sampled waveforms can be saved to floppy or hard disk. Wave files in standard WAV or AIFF format produced using other equipment can also be used by the PSR-8000.

**NOTE**

- The supplied audio CD includes sound sources for sampling.
- No MIDI or TO HOST transmission or reception occurs in the SAMPLING mode.

## PSR-8000 Waves & Waveforms

The terms “wave” and “waveform” have distinct meanings in PSR-8000 sampling terminology, as follows:

### ● WAVE

A “wave” is the raw audio data created whenever you sample a new sound or import a WAV or AIFF format wave file. The PSR-8000 WAVE EDIT mode includes functions which allow you to edit this basic data: e.g. resampling to change the sampling frequency, trimming and looping, normalization for maximum level and minimum noise, etc.

### ● WAVEFORM

All PSR-8000 waves are contained in a “waveform”, which is basically a set of parameters which define the keyboard range over which the wave or waves it contains will play. A waveform can contain one or more waves, and waves can be shared by more than one waveform. Waves in a waveform can be assigned to different ranges of the keyboard, but they cannot be layered (i.e. they will not sound simultaneously when a single key is played). The PSR-8000 WAVEFORM EDIT mode lets you add or delete waves from a waveform, and assign the waves to different keyboard ranges.

**NOTE**

- When you sample a new sound or import a WAV or AIFF format wave, a new waveform which contains the new sampled or imported wave is automatically created. The PSR-8000 saves your edited data as a waveform file.

### ● WAVEFORMS & VOICES

Waveforms created by the PSR-8000 SAMPLING feature can be used in voices in two different ways:

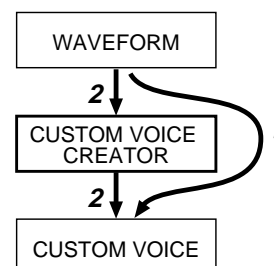
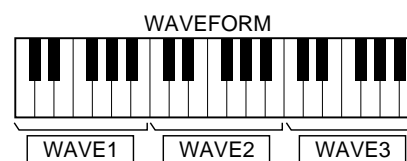
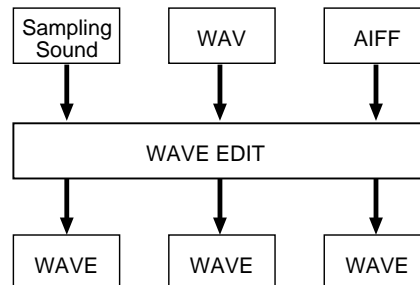



1. You can save the waveform directly as a CUSTOM VOICE (via the WAVEFORM EDIT SAVE AS CUSTOM VOICE function). The CUSTOM VOICE can then be edited via the CUSTOM VOICE CREATOR (page 51) allowing you to layer waveforms with other waveforms as voice “elements”, and apply envelope generators, filtering, modulation, and other voice parameters as required.
2. You can select and use sampled waveforms within the CUSTOM VOICE CREATOR (page 56) with full editing control.

## Setting Up for Sampling

### Connecting the Source

The first step in setting up for sampling is to connect your source — microphone or line — to the PSR-8000.

If you will be using a microphone, set the panel **MIC/LINE** selector to **MIC**, and plug your microphone into the **MIC/LINE IN** jack. A standard dynamic microphone with an impedance of about 250 ohms is recommended (the PSR-8000 does not support phantom-powered condenser microphones).

If you will be sampling from a CD player or other line source set the panel **MIC/LINE** selector to **LINE**. You may have to use a stereo-to-mono cable or a “Y” cable to combine the left- and right-channel output signals from the source device for input to the PSR-8000’s mono **MIC/LINE IN** jack.

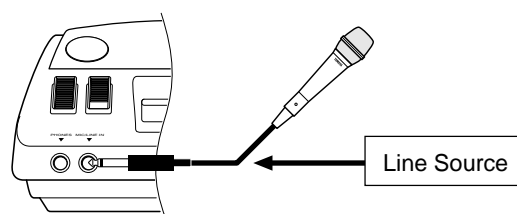

### Setting Levels

Once your source is connected and the **MIC/LINE** selector is set to the appropriate position, you can use the **INPUT VOLUME** control in conjunction with the **SIGNAL** and **OVER** indicators to set the optimum input level.

Begin with the **INPUT VOLUME** control set all the way to the **MIN** position, and play your source at the highest expected volume. Gradually rotate the **INPUT VOLUME** control clockwise until the **SIGNAL** indicator lights whenever an input signal is present and the **OVER** indicator just begins to light, then reduce the **INPUT VOLUME** level to the point at which the **OVER** indicator ceases to light (the **SIGNAL** indicator should still be lit whenever a signal is present). This should be the optimum level setting for your source.

If the **OVER** indicator lights regardless of the setting of the **INPUT VOLUME** control, the output level of your source is probably too high. Compensate by reducing the output level of the source device.

#### NOTE

- Turn the **INPUT VOLUME** control all the way down when connecting or disconnecting a microphone.
- Placing a microphone which is connected to the PSR-8000 too close to the PSR-8000 speakers (or those of an external sound system connected to the PSR-8000) can cause feedback. Adjust the microphone position, and the **MIXING CONSOLE MIC** volume level or **MASTER VOLUME** control level if necessary, so that feedback does not occur.

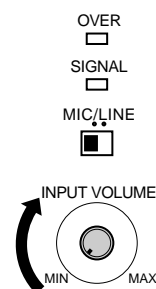

## Sampling & File Import

To sample new material or import waves from disk, go to the **SAMPLING/FILE IMPORT** display by first pressing the panel [SAMPLING] button, and then the **SAMPLING/FILE IMPORT** LCD button which appears in the SAMPLING MENU.

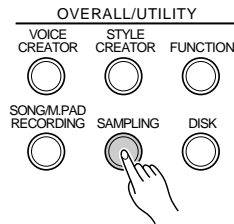

### Sampling New Material

After making sure that your source is properly connected and the input level is set (see “Setting Up for Sampling”, above), set the AUTO TRIGGER LEVEL if necessary (below), set up any PRE EFFECTs you want to use (below), and press the **START** LCD button. “**WAITING**” will appear above the AUTO TRIGGER LEVEL parameter, and the **START** LCD button will change to “**STOP**”.

Play your source and sampling will begin automatically as soon as a signal which exceeds the AUTO TRIGGER LEVEL is detected. Press the **STOP** LCD button to stop sample recording (sampling will continue, using up sample memory as it goes, until the **STOP** LCD button is pressed). Sampling will stop automatically when the available wave memory is full, so be sure to press **STOP** as soon as the sound you want to sample is recorded, otherwise you’ll end up sampling unwanted silence (which can be edited out later).

The amount of remaining sampling time will appear in the upper right corner of the display (this will depend on the total size of the samples currently in the wave memory, and the amount of wave memory available).

#### NOTE

- Prior to actually starting sample recording, the AUTO TRIGGER LEVEL display can be used as a “level meter” to check that the source level is higher than the set trigger level.
- The PSR-8000 records at a sample rate of 44.1 kHz.
- Although the wave memory of the PSR-8000 can be expanded to 33 megabytes (page 152), the maximum size of a single sample recording is 32 megabytes.

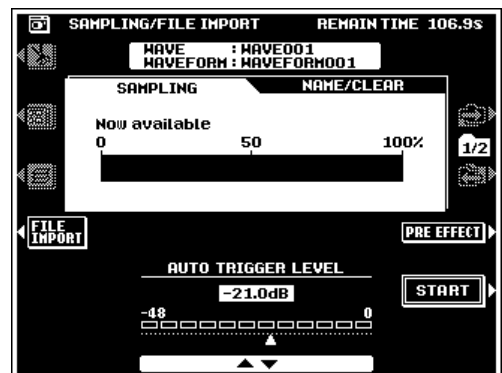

## ● AUTO TRIGGER LEVEL

For most applications the default AUTO TRIGGER LEVEL setting of “-21.0dB” will provide satisfactory results. If you want to trigger sampling at a lower or higher level, however, use the **AUTO TRIGGER LEVEL** LCD dials to set the level anywhere from -47.6 to -0.3 dB. Below the “-47.6dB” setting is a “MANUAL” mode in which automatic triggering does not occur. In the MANUAL mode sampling begins immediately the **START** LCD button is pressed.

## ● PRE EFFECT

Press the **PRE EFFECT** LCD button to go to the **PRE EFFECT** display. This display page allows you to set up a maximum of three DSP effects to be applied to the source sound as it is sampled. The actual DSPs used and the default settings are:

Sample DSP	PSR-8000 DSP Block	Default Settings
DSP1	DSP (MIC)	NoiseGate
DSP2	DSP (LEAD)	Thru
DSP3	DSP (RIGHT2)	Thru

Please note that the DSP blocks are connected in series: i.e. DSP1 → DSP2 → DSP3.

To change a PRE EFFECT DSP setup, select the desired DSP via the ▲ and ▼ LCD buttons to the left of the display. Use the **TYPE** LCD dials to select an effect type, the **PARAMETER** LCD dials to select any of the parameters available for the selected effect type, and the **VALUE** LCD dials to change the value of the selected parameter as required. For some effects the **WET/DRY** parameter can be used to change the balance between the direct (“dry”) and effect (“wet”) sound as required.

Press the **EXIT** LCD button to return to the **SAMPLING/FILE IMPORT** display when done.

## ● Importing Waves From Disk

To import previously-saved waveform files or standard WAV or AIFF format files from disk, insert the appropriate disk into the PSR-8000 floppy disk drive (not necessary if the file to be loaded is on the optional internal hard disk), then press the **FILE IMPORT** LCD button in the **SAMPLING/FILE IMPORT** display.

If the optional hard disk is present, use the **DIRECTORY** LCD dials to select the floppy disk or hard disk directory containing the file(s) to be loaded. All loadable files within the selected directory will be displayed in the **FILE LIST**. Use the **FILE LIST** LCD dials to select the file you want to load, then press the **EXECUTE** LCD button to load the file.

Press the **EXIT** LCD button to return to the **SAMPLING/FILE IMPORT** display when done. After loading the amount of remaining sampling time will be reduced by the size of the loaded data.

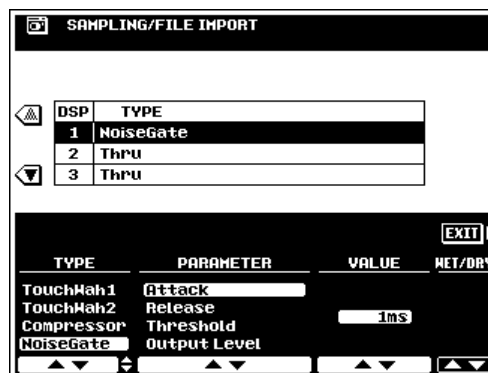



### NOTE

- Since all PSR-8000 samples are monaural, stereo DSP effects may not produce the expected sound.



### NOTE

- If the sample memory is full, or the selected file is larger than the available sample memory, an alert message will appear and loading will not be possible.
- A  icon between the FILE LIST number and file name indicates a WAV or AIFF format wave file, while a  icon indicates a waveform file.

## ● Monitor Selection

Use the  LCD button to switch between the currently selected wave and the currently selected panel voice. The LCD button is only available when at least one wave is in the sample memory.

## ● Defragmenting the Sample Memory

If you've been sampling for a while, and/or loading and manipulating a number of waves, the wave RAM memory can become "fragmented" (normally contiguous files become broken up into several fragments) limiting the amount of memory available for continuous sampling.

To defragment the sample memory press the defragment  LCD button, and then press the **OK** LCD button in the confirmation display.



## ● Direct Access To the WAVE EDIT and WAVEFORM EDIT Displays

The **WAVE EDIT** and **WAVEFORM EDIT** displays — also accessible via the SAMPLING MENU when at least one wave is in the wave memory — can be directly accessed from the **SAMPLING/FILE IMPORT** display by pressing the appropriate LCD button:

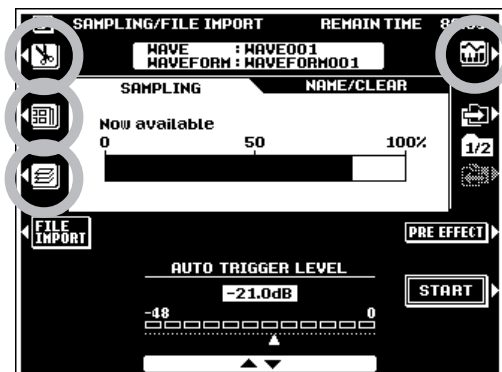
WAVE EDIT .....   
 WAVEFORM EDIT .... 



## NAME/CLEAR

Use the  LCD button to the right of the display to go to the **NAME/CLEAR** display. Use the  and  LCD buttons to the left of the display to select the **WAVE NAME** or **CLEAR** function.

### 1: WAVE NAME

Enter an original name for the selected wave as described on page 21.

### 2: CLEAR

Use the **WAVEFORM** and **WAVE** LCD dials to select a waveform and wave.

The **WAVEFORM CLEAR** LCD button clears the waveform and the waves it contains. Waves which are actually included in other waveforms but are shared by the selected waveform will not be cleared.

The **WAVE CLEAR** LCD button clears only the selected wave. If the selected waveform only has one wave, you will be asked to confirm whether it is OK to clear the waveform. You will also be alerted if the selected wave is shared by other waveforms.

Press the **[SAMPLING]** or **[EXIT]** button to return to the **SAMPLING MENU** display.

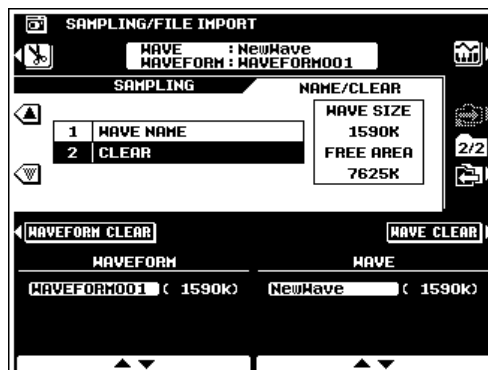
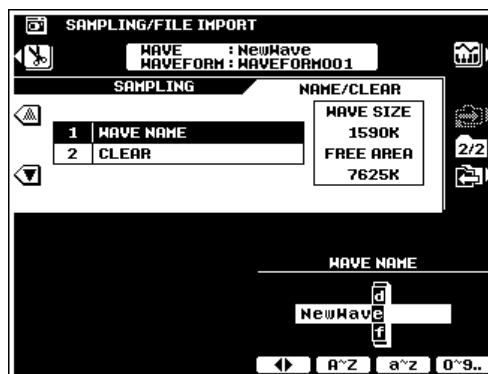

## Wave Edit

The **WAVE EDIT** display is accessible from the **SAMPLING MENU** when at least one wave is in the wave memory.





The WAVE EDIT mode includes the following functions:

### EDIT

1: SELECT WAVE .....	93
2: RESAMPLING .....	93
3: LOOP POINT .....	94
4: NORMALIZE .....	95
5: VOLUME/TUNE .....	95

### NAME/CLEAR/DISK

1: WAVE NAME .....	96
2: CLEAR .....	96
3: EXPORT AS WAV .....	96
4: DELETE .....	96

Select the **EDIT** or **NAME/CLEAR/DISK** display via the  and  LCD button to the right of the display, then use the  and  LCD buttons to the left of the display to select the desired function.

In all edit displays the  LCD button can be used to switch between the currently selected wave and the currently selected panel voice.

While in the WAVE EDIT mode, the  LCD button in the upper left corner of the display will take you directly to the WAVEFORM EDIT mode (page 97). The **[EXIT]** button will take you back to the SAMPLING MENU.

## EDIT .....

### 1: SELECT WAVE

Selects the wave to be edited. Use the **WAVEFORM** LCD dials to select the waveform containing the wave to be edited, then use the **WAVE** LCD dials to select the wave to be edited. The name of the selected wave and waveform appear at the top of the display.

### 2: RESAMPLING

The PSR-8000 originally records waves at 44.1 kHz. WAV and AIFF files are also imported as 44.1 kHz waves. The RESAMPLING function lets you reduce the sampling frequency of waves, thus reducing the amount of memory they occupy. Please note, however, that reducing the sampling frequency also reduces the sound quality.

The original sampling frequency of the selected wave is shown under **ORIGINAL SAMPLING FREQ** on the display. Use the **RESAMPLING FREQ** LCD dials to select the desired resampling frequency. Only resampling frequencies which are lower than the original sampling frequency will be available (resampling will not be possible beyond 11.025 kHz). Press the

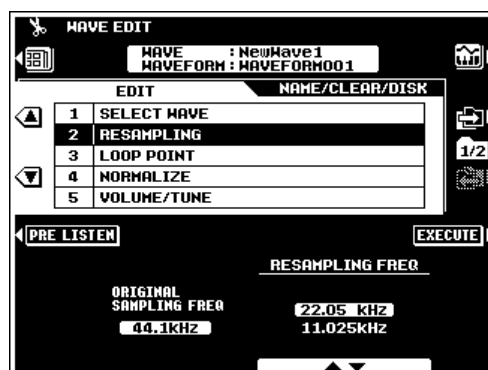
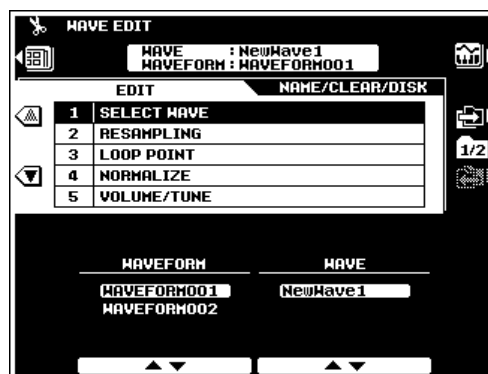

**PRE LISTEN** LCD button to hear how the resampled wave will sound before actually resampling the wave. Press the **EXECUTE** LCD button to actually resample the selected wave.

**NOTE**

- Resampling can cause the loop points (see **LOOP POINT**, below) to shift, resulting unwanted noise. If this happens use the **LOOP POINT** function to readjust the loop points.

### 3: LOOP POINT

The controls in this display allow you to trim and loop your sampled waves as required.

The **LOOP/ONE SHOT/REVERSE** LCD dials determine whether the wave will be played as a **LOOP** (i.e. the wave will “loop” as long as a key is held), as a **ONE SHOT** sample (i.e. the wave will play through once when a key is pressed and then stop), or as a **REVERSE** one-shot sample (i.e. the wave plays through once in reverse).

The **AUTO ZERO** and **LOOP** LCD dials are used to trim sample in the **ONE SHOT**, **REVERSE**, and **LOOP** modes. When the **ONE SHOT** or **REVERSE** mode is selected, the **LOOP SELECT** LCD dials select either the **START** or **END** address of the wave. When the **LOOP** mode is selected the **LOOP SELECT** LCD dials select the **START**, **LOOP START** or **LOOP END** address. The **LOOP ADDRESS** LCD dials are used to set the selected address as required. The large **ADDRESS ▲▼** dials vary the selected address in the largest steps (the highest four digits) for coarse adjustment, the medium **▲▼** dials vary the selected address in medium steps (the 3rd and 4th digits), and the small **▲▼** vary the selected address in the smallest steps (the lowest two digits) for fine adjustment. The **LEVEL** indicators to the right of each address show the signal level at the current address — the longer the bar, the higher the signal level. This makes it easier to locate zero-level points for noise-free trimming and looping. The **AUTO ZERO** also aid in locating zero-level points: when the **AUTO ZERO** parameter is turned **ON**, the **LOOP ADDRESS** LCD dials will automatically only select points in the wave corresponding to, or adjacent to, zero level points.

Use the **EXTRACT** LCD button to automatically remove all data prior to the specified **START** point and after the **END** or **LOOP END** point of your sample.

You can play and listen to the wave at any time during the editing process as long as the wave is selected via the  monitor LCD button. When all **LOOP** parameters have been set up as required, press the **EXECUTE** LCD button to actually edit the selected wave.

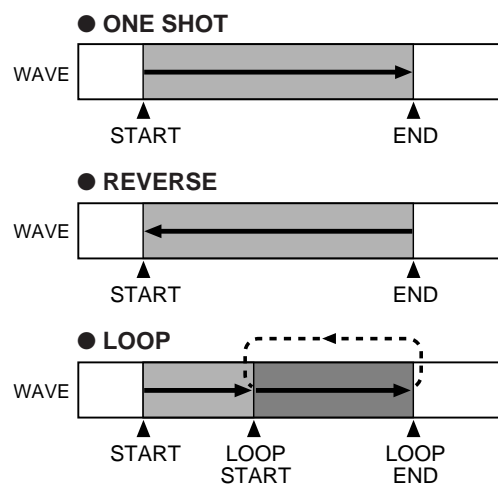
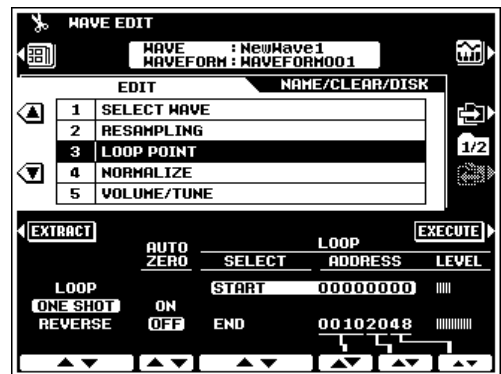

#### 4: NORMALIZE

This function increases the overall level of the selected wave to ensure that it uses the full range of digital values. Press the **EXECUTE** LCD button to normalize the selected wave. No change will occur if the selected wave already uses the full range of digital values.

#### 5: VOLUME/TUNE

The **VOLUME** LCD dials set the volume of the selected wave.

The **TUNE COARSE** and **FINE** LCD dials can be used to tune the selected wave: **COARSE** tunes in semitone increments over a  $-63 \dots +63$  range, and **FINE** tunes in 1-cent increments over a  $-50 \dots +50$  range.

When the **FIXED PITCH** parameter is turned OFF, the pitch of wave playback will correspond to keyboard pitch. When ON, the playback pitch will remain the same (corresponding to the pitch of the C3 key) regardless of which key is pressed.

#### ● TUNING BY TEMPO

The **TUNING BY TEMPO** LCD button accesses parameters that can be used to “tune” the wave to fit a specified playback tempo. In other words, the wave is stretched (tuned down) or compressed (tuned up) so that it plays back over the specified number of measures at the specified time signature and tempo. This capability is particularly useful when the sample is a phrase rather than a simple sound. The wave will only play back at the specified tempo, however, when played at its original pitch (usually the pitch played by the C3 key).

Use the **BEAT** LCD dials to specify the number of beats per measure, the **UNIT** LCD dials to specify the number of measures the wave should play over, and the **DESIRED TEMPO** LCD dials to specify the tempo at which the wave should play.

When done, press the **SET** LCD button to actually set the wave tempo, or **CANCEL** to cancel the operation and return to the **PARAMETER** display. Please note that the sound of the wave will not change until the **SET** LCD button is pressed (i.e. there is no pre-listen capability while setting up the parameters). Once the **SET** LCD button has been pressed, the amount of tuning applied is reflected in the **TUNE COARSE** and **FINE** parameters.

#### NOTE

- When a **LOOP** is selected the entire loop is tuned, but the portion of the loop between the **LOOP START** and **LOOP END** points is adjusted to fit the specified number of measures.

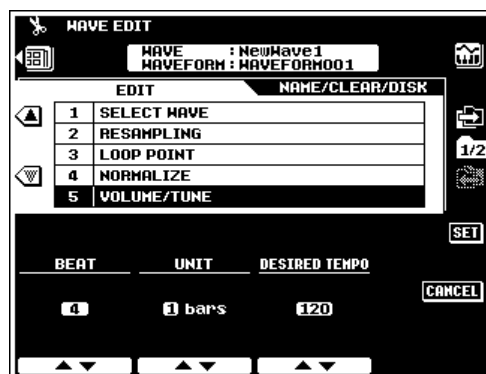
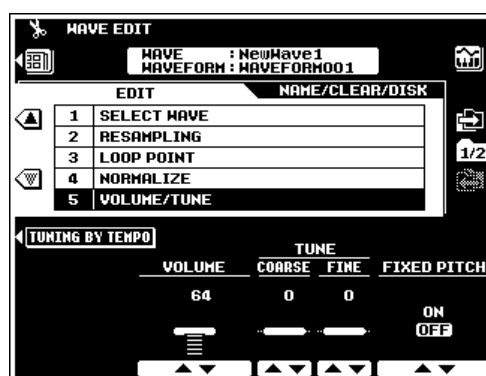

## NAME/CLEAR/DISK .....

**NOTE**

- The **FREE AREA** value in the **WAVE NAME** and **CLEAR** displays indicates free wave RAM area, while the **FREE AREA** value in the **EXPORT AS WAV** and **DELETE** displays indicates free disk area.

### 1: WAVE NAME

Enter an original name for the selected wave as described on page 21.

### 2: CLEAR

Use the **WAVEFORM** and **WAVE** LCD dials to select a waveform and wave.

The **WAVEFORM CLEAR** LCD button clears the entire waveform and the waves it contains. Waves which are actually included in other waveforms but are shared by the selected waveform will not be cleared.

The **WAVE CLEAR** LCD button clears only the selected wave. If the selected waveform only has one wave, you will be asked to confirm whether it is OK to clear the entire waveform. You will also be alerted if the selected wave is shared by other waveforms.

### 3: EXPORT AS WAV

This function exports the current wave as a WAV file which can be loaded and used by other instruments or computers which can handle the WAV format.

If the optional hard disk is present, use the **DIRECTORY** LCD dials to select the floppy disk or hard disk directory to which you want to save the file. Press the **NEW FILE** LCD button to create a new file, or overwrite an existing file by using the **FILE LIST** LCD dials to select the target file and then pressing the **OVERWRITE** LCD button.

**NOTE**

- Since this function saves the wave in standard WAV format, parameters unique to the PSR-8000 are not saved.

### 4: DELETE

Use this function to delete unwanted wave or waveform files from disk.

If the optional hard disk is present, use the **DIRECTORY** LCD dials to select the floppy disk or hard disk directory containing the file you want to delete. Use the **FILE LIST** LCD dials to select the target file and then press the **EXECUTE** LCD button to delete it.

**NOTE**

- A  icon between the **FILE LIST** number and file name indicates a WAV or AIFF format wave file, while a  icon indicates a waveform file.

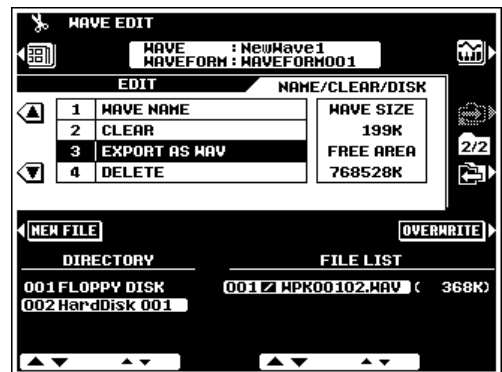



## Waveform Edit

The **WAVEFORM EDIT** display is accessible from the **SAMPLING MENU** when at least one wave is in the wave memory.

The WAVEFORM EDIT mode includes the following functions:

### EDIT

- 1: SELECT WAVEFORM ..... 97
- 2: ADD WAVE ..... 97
- 3: MOVE START NOTE/VOLUME/DELETE WAVE ..... 98

### NAME/CLEAR/DISK

- 1: WAVEFORM NAME ..... 98
- 2: CLEAR ..... 98
- 3: SAVE ..... 98
- 4: DELETE ..... 98

### STORE AS CUSTOM VOICE

- 1: CUSTOM VOICE NAME ..... 99
- 2: STORE AS CUSTOM VOICE ..... 99
- 3: CLEAR CUSTOM VOICE ..... 99

Select the **EDIT**, **NAME/CLEAR/DISK**, or **STORE AS CUSTOM VOICE** display via the  and  LCD button to the right of the display, then use the  and  LCD buttons to the left of the display to select the desired function.

In all edit displays except ADD WAVE (see below) the  LCD button can be used to switch between the currently selected waveform and the currently selected panel voice.

While in the WAVEFORM EDIT mode, the  LCD button in the upper left corner of the display will take you directly to the WAVE EDIT mode (page 93). The **[EXIT]** button will take you back to the SAMPLING MENU.

## EDIT

### 1: SELECT WAVEFORM

Use the **WAVEFORM** LCD dials to select the waveform to be edited. The name of the selected waveform appears at the top of the display.

### 2: ADD WAVE

This function can be used to add a wave from a different waveform to the currently selected waveform. When a waveform contains two or more waves, the individual waves must be assigned to different areas of the keyboard (the waves cannot be “layered”).

Use the **SOURCE WAVEFORM** LCD dials to select the waveform containing the wave to be added, and the **SOURCE WAVE** LCD dials to select the wave to be added. Use the **START NOTE** LCD dials to specify the note from which the added wave will begin playing. The START NOTE can also be specified by pressing the appropriate key on the keyboard while holding the **[DIRECT]** button. For example, if you select C3 as the START NOTE, the original wave will play up to B2, and the

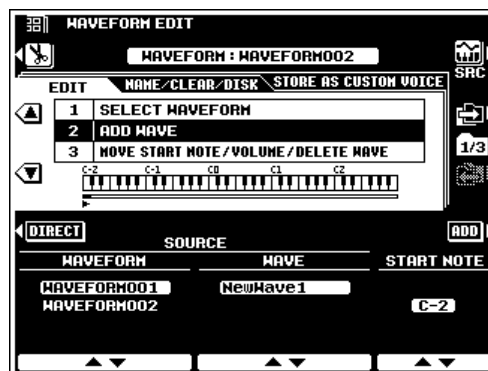
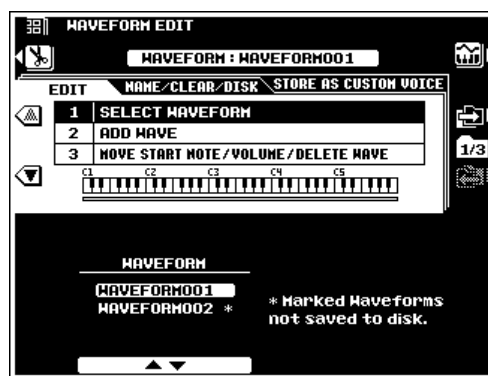

added waveform will play from C3 up.

Press the **ADD** LCD button to actually add the selected wave.

**NOTE**

- The same wave cannot be added for use in multiple keyboard ranges.
- When the **ADD WAVE** function is selected the **TEST** monitor LCD button switches between the source wave, destination wave, and panel voice.

### 3: MOVE START NOTE/VOLUME/DELETE WAVE

Use the **WAVE** LCD dials to select a wave to be edited.

The **START NOTE** LCD dials can be used to move the start note of the selected wave (see “ADD WAVE”, above). The **START NOTE** can also be changed by pressing the appropriate key on the keyboard while holding the **[DIRECT]** button. The **START NOTE** of the lowest wave in the waveform (i.e. the wave starting at C-2) cannot be changed. When the **START NOTE** of a wave is change, the range of the next lowest wave in the waveform will expand or contract accordingly.

The **VOLUME** LCD dials adjust the volume of the selected wave in relation to other waves in the waveform.

The **DELETE** LCD button deletes the selected wave from the waveform. When a wave is deleted the range of the next lowest wave will expand to include the range originally covered by the deleted wave. If the deleted wave is the lowest in the waveform (i.e. its **START NOTE** is C-2) the range of the next highest wave will expand downward to include the range of the deleted wave. The last wave in the waveform cannot be deleted.

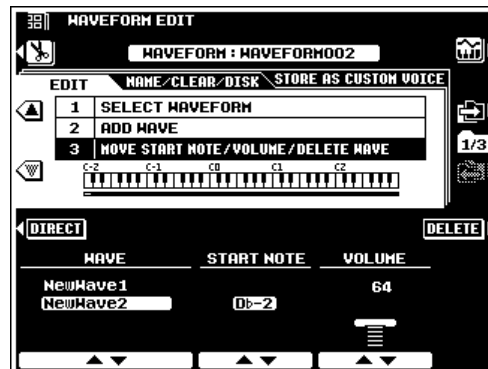

## NAME/CLEAR/DISK

### 1: WAVEFORM NAME

Enter an original name for the selected waveform as described on page 21.

### 2: CLEAR

Clears the specified **WAVEFORM** or **WAVE** from memory. Operation is the same as in the **WAVE EDIT** mode (page 96).

### 3: SAVE

This function saves the selected waveform to disk. Operation is the same as in the **WAVE EDIT** mode **EXPORT AS WAV** function (page 96).

### 4: DELETE

Deletes unwanted wave or waveform files from disk. Operation is the same as in the **WAVE EDIT** mode (page 96).

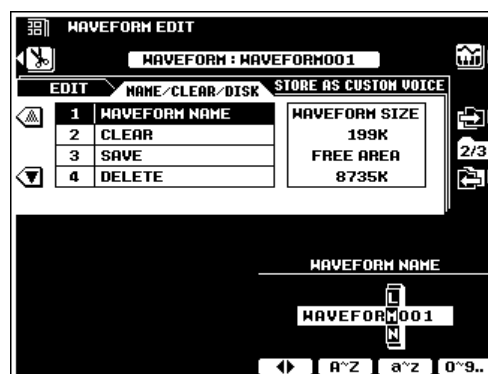

## STORE AS CUSTOM VOICE

### 1: CUSTOM VOICE NAME

Enter an original name for the custom voice as described on page 21.

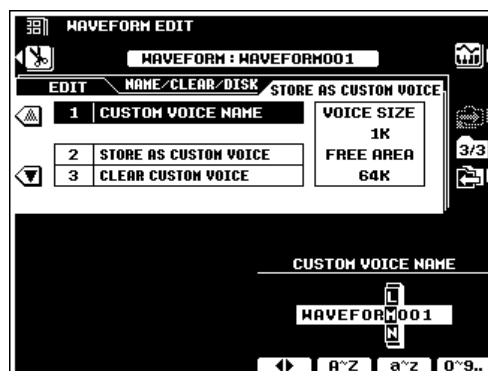

### 2: STORE AS CUSTOM VOICE

This function stores the current waveform as a custom voice which can be edited via the CUSTOM VOICE CREATOR (page 51) or selected via the VOICE [CUSTOM VOICE] button and played on the PSR-8000 keyboard in the same way as the other voices.

Use the **STORE AS CUSTOM VOICE** LCD dials to select the CUSTOM VOICE number to which you want to store the waveform, then press the **EXECUTE** LCD button.

**NOTE**

- The corresponding waveform must also be saved to disk in order to use the stored custom voice the next time the PSR-8000 is turned on. If the corresponding waveform has not been saved to disk, an alert will appear following the SAVE AS CUSTOM VOICE operation.
- Waveform data is not actually stored with the CUSTOM VOICE data, but is retained in the wave RAM memory. When the FUNCTION mode AUTO LOAD function (page 131) is ON and a disk containing the appropriate waveform data is loaded, the waveform data for the custom voices will automatically be loaded into the wave RAM memory when the PSR-8000 is turned on. If the AUTO LOAD function is off or the appropriate waveform data is not found when the PSR-8000 is turned on, the corresponding custom voices will automatically be erased.
- The VOICE SIZE shown on the display is the size of the custom voice data (always 1K, not including the waveform data). The FREE AREA is the total amount of remaining CUSTOM VOICE memory.

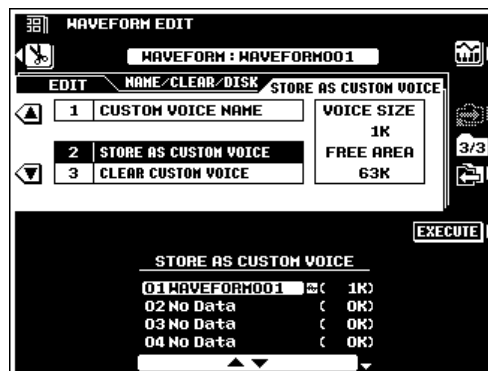

### 3: CLEAR CUSTOM VOICE

Use the **CLEAR CUSTOM VOICE** LCD dials to select a CUSTOM VOICE to be cleared, then press the **EXECUTE** LCD button.

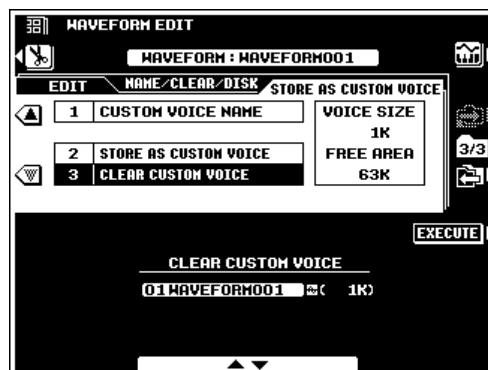

# Song Playback

The PSR-8000 SONG mode allows song data to be played back from a floppy disk or the optional hard disk. The song file types which can be played by the PSR-8000 are: songs recorded on the PSR-8000, Yamaha DOC files, PianoSoft type files and GM/XG/XF song (SMF formats 0 and 1) files.

## Procedure: Song Playback

### 1 Insert a song disk.

Insert a song disk into the PSR-8000 disk drive. This step can be skipped if you will be playing a song from the optional internal hard disk.

### 2 Engage the song mode & select a song.

Press the [SONG] button to engage the SONG mode. The [SONG] button indicator will light and a SONG name will appear in place of the style name on the display. You can exit from the SONG mode by pressing the [SONG] button again so that its indicator goes out.

Press the [SONG SELECT] button to go to the song select display if you want to select a different song. In fact, pressing the [SONG SELECT] button automatically engages the SONG mode if the [SONG] button has not been pressed, so you can engage the SONG mode and go to the **SONG SELECT** display in one step. You can return to the main SONG mode display by pressing the [SONG] or [EXIT] button. If the optional hard disk is present the **DIRECTORY** LCD dial in the **SONG SELECT** display can be used to select the floppy disk or the hard disk directory containing the desired song. Use the **SONG SELECT** LCD dials to select the song you want to play.

#### ● The Song Type Symbols

The symbol which appears between the song number and song name indicates the song file type, as follows:

G	GM (General MIDI)
U	User song
P	PianoSoft type file
D	DOC file
X	XG or XF file
N	New song (only appears in the SONG SELECT display when the SONG RECORD mode is engaged to select a new song for recording)
/	Other file type

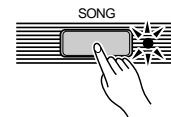

## 3 Select a play mode.

Use the **MODE** LCD dials to select a play mode:

<b>SINGLE</b>	Plays only the selected “CURRENT” song, or the “CURRENT” and “NEXT” songs if a “NEXT” song has been entered (see below).
<b>ALL</b>	Plays all songs in the SONG SELECT display song list in order, beginning with the currently selected song. Also see “Enter Next Song”, below.
<b>RANDOM</b>	Plays all songs in the SONG SELECT display song list in random order. Also see “Enter Next Song”, below.

Also, use the **REPEAT** dial to turn the repeat mode ON or OFF as required. When ON, playback will repeat continuously until stopped.

## 4 Start/stop playback.

Press the **[START/STOP]** button (in the ACCOMPANIMENT CONTROL section) to start playback. You can play along on the keyboard during playback. Playback will stop automatically when the specified song(s) have been played all the way through (unless the repeat mode is ON). You can also stop playback at any time by pressing the **[START/STOP]** button.

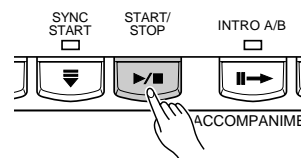

## Enter Next Song

In addition to selecting a single “CURRENT” song, you can enter a “NEXT” song which will play after the CURRENT song has finished. Press the **ENTER NEXT SONG** LCD button in the upper left corner of the **SONG SELECT** display. The “NEXT” section of the directory number/song name display (the directory number only appears when the internal hard disk is present) will be highlighted and you can select the next song via the **DIRECTORY** (if the optional hard disk is present) and **SONG SELECT** LCD dials. The **ENTER NEXT SONG** LCD button will have changed to “**ENTER CURRENT SONG**”, and you can use this LCD button to switch back and forth between CURRENT and NEXT song entry as required.

When a NEXT song is specified, the **CLEAR NEXT SONG** LCD button will be available to clear the NEXT song, if necessary. No directory number or song name appears in the NEXT section of the display when no NEXT song has been specified or the NEXT song has been cleared.

When the **SINGLE** playback mode is selected the CURRENT and NEXT songs will play and then playback will stop (unless **REPEAT** is ON). When the **ALL** or **RANDOM** playback mode is selected the CURRENT and NEXT song will play, then the remaining songs in the list will play in the specified mode.



### NOTE

- The **NEXT** song can be changed while the **CURRENT** song is playing, but the **CURRENT** song cannot be changed during playback.

## Pause, Fast Forward & Reverse

When you press the [START/STOP] button to stop playback, the song position returns to the beginning of the song. The PAUSE [||] button, however, lets you pause playback and then start again from the same point in the song. Playback can be restarted either by pressing the PAUSE [||] button again or by pressing the [START/STOP] button.

The F.F. [▶▶] (Fast Forward) and REW [◀◀] (Reverse) buttons rapidly move the playback location forward and backward, respectively.

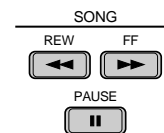
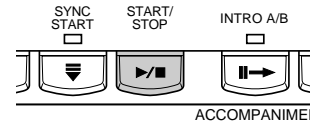

## Lyric Display

When an XF or SMF song file which includes lyric data is selected, the **LYRIC** LCD button next to the song name in the main SONG mode display will become available. Press the **LYRIC** LCD button to display the song lyrics.



- The PSR-8000 is compatible with XF and most SMF song files containing Lyric Meta-Event data.
- If an XF song which includes chord data is selected, the chords will be displayed below the song name in the main display and in the lyrics display.

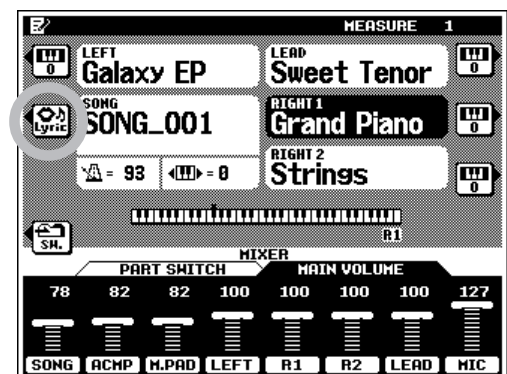

## The CHORD DETECT and VOCAL HARM. Parameters

The CHORD DETECT and VOCAL HARM. parameters in the **SONG SELECT** display function as follows:

### CHORD DETECT

The **CHORD DETECT** LCD dial specifies the song track which will be used for chord detection by the PSR-8000 HARMONY/ECHO feature and VOCAL HARMONY Chordal type effects. When set to “OFF” neither of these features will function. When “XF” is selected chord data is derived from chord meta-events in an XF song file.

### VOCAL HARM.

The **VOCAL HARM.** LCD dial specifies the song track from which the VOCAL HARMONY Vocoder type note data is to be derived. The specified track’s volume, pan, detune, modulation, and pitch bend settings will also affect the harmony notes for any VOCAL HARMONY type. Select “OFF” if the selected song does not include a track intended for use with the VOCAL HARMONY feature.

When using commercially available software which includes a Vocal Harmony track, use the **VOCAL HARM.** LCD dial to specify the Vocal Harmony track. Then go to the **FULL MIXING CONSOLE EFFECT TYPE** display by pressing the [VOCAL HARMONY (8)] button while holding the [DIRECT ACCESS] button, and select one of the “**Karaoke\*\*\*\***” VOCAL HARMONY types. (When using an XG song which includes a Vocal Harmony track, the appropriate settings will be made automatically when the song is selected.)



## Setting the Song Playback Order

This function can be used to change the order of the songs in the song list, thus specifying the song playback order when the ALL playback mode is selected.

From the **SONG SELECT** display press the **SONG ORDER** LCD button to go to the **SONG ORDER** display (the **SONG ORDER** LCD button will not be available during song playback, when no songs are available, or when a write-protected song disk is used).

First use the ▲ ▼ dials to select a song you want to move, then press the **SELECT** LCD button. At this point the **CANCEL** LCD button can be used to cancel the selection if you want to select a different song. Next use the ▲ ▼ dials to select the location in the list at which you want to insert the selected song. Press the **INS.** LCD button to insert the selected song at the specified location. Repeat this process to put the songs in the desired order.

Use the **SAVE** LCD button if you want to save the new song order to disk. If you don't save the new song order to disk, the original order will be restored when disk directory is changed, when the floppy disk is removed, or when the power is turned off.

Press the **RETURN** LCD button to return to the **SONG SELECT** display when done.

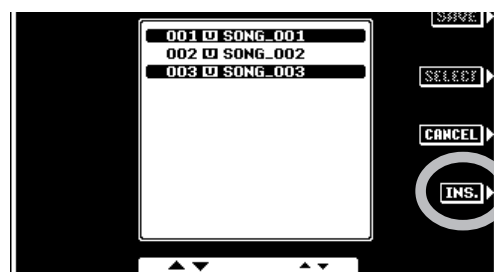
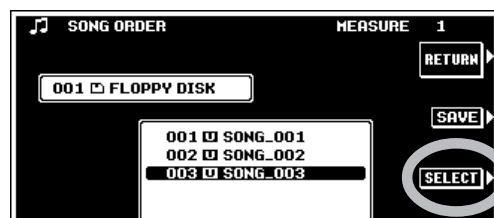

## MIXING CONSOLE Operation During Song Playback

Both the **FADER** and **FULL MIXING CONSOLE** displays are available in the SONG playback mode. See “The Mixing Console” section on page 39 for general MIXING CONSOLE operating instructions.

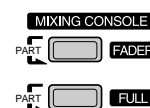

### FADER

When the **VOLUME** display is selected, the **FADER** button alternately selects the **MAIN VOLUME** and **TRACK VOLUME** controls. The **MAIN VOLUME** controls are the same as in the normal play mode (page 24).

The number of volume parameters in the **TRACK VOLUME** display will depend on the type of song being played. If an original song recorded on the PSR-8000 using the **QUICK RECORD** mode is being played, two volume part parameters will be available: **MANUAL** and **ACMP**. If an original song recorded on the PSR-8000 using the **MULTITRACK RECORD**



mode or a GM/XG song is being played, individual parameters for all 16 tracks will be available: **TR1** through **TR16** (track groups **TR1—TR8** and **TR9—TR16** will be selected in sequence when the **[FADER]** button is pressed). If a Yamaha DOC song is being played use the **RHY**, **BASS**, **ORCH.**, **LEFT**, and **RIGHT** part LCD dials to set the volume of the corresponding tracks. If a PianoSoft type song file is being played use the **ORCH**, **LEFT**, and **RIGHT** part LCD dials to set the volume of the corresponding tracks.

When the **SWITCH** display is selected the **FADER** button alternately selects the standard **PART SWITCH** controls found in the normal **PLAY** mode (page 22), and independent **SOLO/PLAY/MUTE** switches for each of the available tracks. Muted tracks or groups of tracks do not play. If a track or group of tracks is set to **SOLO** only that track or group will play.

The track indicators above the track volume or mute/solo parameters indicate which parts correspond to which tracks, and which tracks contain data and which are muted, as shown below.

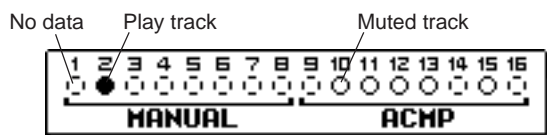

**NOTE**

- When a GM/XG song or a song with the “/” symbol in the **SONG SELECT** display is played, all tracks appear on the display as if they contain data, even if they don't.

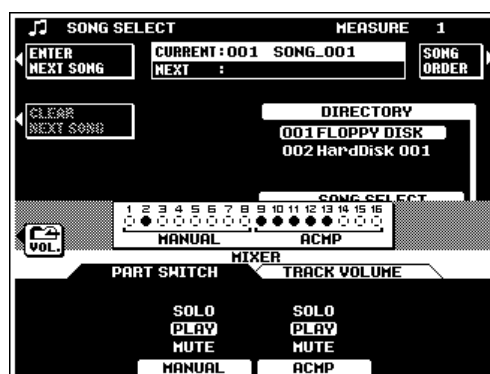

## FULL

When the **FULL MIXING CONSOLE VOLUME/PAN/EQ, FILTER, or EFFECT DEPTH** display is selected, the **[FULL]** button will select the normal parts display, song track **TR1—TR8**, and song tracks **TR9—TR16** in sequence. When a song track display is selected “---” will appear in place of a value for parameters which are not available.





# Song Recording

The PSR-8000 SONG RECORD mode allows anything you play to be recorded to floppy or hard disk. A QUICK RECORD mode provides an easy way to record a melody with accompaniment, while a MULTI TRACK record mode allows independent recording on up to 16 tracks. There's also a CHORD STEP record mode available via the QUICK record mode.

**NOTE**

- PSR-8000 songs are recorded using SMF format 0.
- Songs recorded using the XG category voices are XG compatible.

## Procedure: Song Recording

### 1 Insert a recordable disk.

Insert a properly formatted disk in the PSR-8000 disk drive. This step is not necessary if you will be recording to an internal hard disk (optional).

### 2 Engage the song record mode.

Press the [SONG/M. PAD RECORDING] button to engage the SONG/MULTI PAD RECORD mode. The **RECORDING MENU** display will appear. You can return to the normal play mode by pressing the [SONG/M. PAD RECORDING] button again, or by pressing the [EXIT] button.

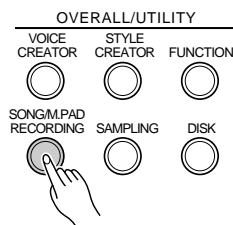

### 3 Select a directory and/or song, if necessary.

This step can be skipped if the desired directory/song is already selected or you want to record a new song from scratch.

If you want to select a directory and/or add to an existing song, press the [SONG SELECT] button to go to the **SONG SELECT** display (described in the “Song Playback” section, above) and select the desired directory and/or song. A **DIRECTORY** LCD dial will be available in the **SONG SELECT** display only when the optional hard disk is present. It can be used to select the floppy disk or the hard disk directory to which the song is to be recorded.

Press the [EXIT] or [SONG/M.PAD RECORDING] button when done to return to the **RECORDING MENU** display.



## 4 Select a record mode.

To record a new song, press the **QUICK RECORD NEW SONG** or **MULTI TRACK RECORD NEW SONG** button to select the corresponding record mode.

If you want to add to an existing song, select the **QUICK RECORD CURRENT SONG** or **MULTI TRACK RECORD CURRENT SONG** option.



## Procedure: Quick Record

The QUICK RECORD mode, as its name suggests, makes track selection and recording easy by grouping the accompaniment and manual tracks.

## 1 Set the track modes.

Use the **MANUAL** and **ACMP** LCD dials to select the REC mode for the track(s) to be recorded, the PLAY mode for the tracks to be played while recording, or the MUTE mode for tracks neither to be played or recorded. The PLAY mode can only be selected for tracks which contain data.

### NOTE

- Note that the SYNC START mode is automatically engaged when the QUICK RECORD NEW SONG mode is selected, so be careful not to play the keyboard before you're ready to actually start recording, or recording will begin automatically. SYNC START can be disengaged by pressing the [SYNC START] button.



## 2 Set up for the recording.

Select the required voice(s), select a style, turn AUTO ACCOMPANIMENT on if required (see "NOTE" below). Set up all parameters as desired for recording. The voices, multi-pad notes, and accompaniment parts are recorded on the various tracks as listed to the right.

The FADER and FULL MIXING CONSOLE displays can be used to set the initial values of the available parameters prior to recording. The FADER and FULL MIXING CONSOLE buttons alternately select the MAIN and ACMP MIXING CONSOLE displays (except in the FULL MIX-

MANUAL		ACCOMPANIMENT	
VOICE	TRACK	PART	TRACK
LEAD voice	1	RHYTHM 2	9
RIGHT 1 voice	2	RHYTHM 1	10
RIGHT 2 voice	3	BASS	11
LEFT voice	4	CHORD 1	12
MULTI PAD 1	5	CHORD 2	13
MULTI PAD 2	6	PAD	14
MULTI PAD 3	7	PHRASE 1	15
MULTI PAD 4	8	PHRASE 2	16

ING CONSOLE EFFECTTYPE, TUNING, and MASTER EQ displays). In the FADER MIXING CONSOLE both the VOLUME and PART SWITCH displays are available. In the FULL MIXING CONSOLE the VOLUME/PAN/EQ, FILTER, EFFECT DEPTH, EFFECT TYPE, and TUNING displays include recordable parameters.

**NOTE**

- If you turn the panel [AUTO ACCOMPANIMENT] button on, the ACMP tracks will automatically be set to the REC mode.
- If the REC mode is engaged for the ACMP tracks the panel [AUTO ACCOMPANIMENT] button will be turned on automatically.
- A different style cannot be selected if the ACMP tracks contain previously recorded data (unless the ACMP tracks are set to the REC mode).

### 3 Turn the metronome on or off as required.

Use the metronome-icon LCD button to turn the metronome ON if you want to record while monitoring the metronome sound (the metronome sound is not recorded), or OFF if you don't want to hear the metronome while recording.

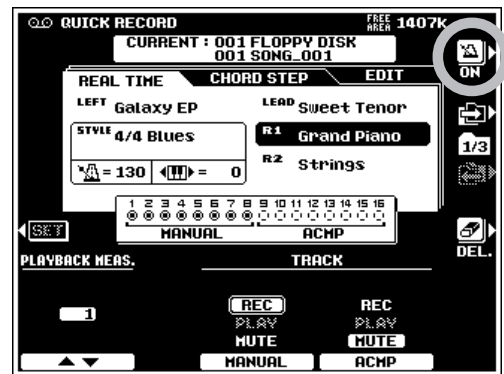

### 4 Set a start measure, if necessary.

If you are adding to a previously-recorded song you might want to start recording from a specified measure. To do this use the **PLAYBACK MEAS.** dials to specify the measure you want to start recording from, then press the **SET** LCD button to actually move to the specified measure.

**NOTE**

- If a measure is specified beyond the last measure which contains data, the last measure which contains data will automatically be selected.
- The **PLAYBACK MEAS.** must be set to "1" in order to record the **ACMP** tracks.



### 5 Start recording.

If the SYNC START mode is engaged (it is engaged automatically when the QUICK RECORD mode is selected) you can start recording by simply playing on the keyboard. Otherwise use the [START/STOP] button.

**NOTE**

- Any previous data in a track will be erased when that track is recorded.
- Changes made to the recordable FADER and FULL MIXING CONSOLE parameters will be recorded.
- When the record mode is engaged for any tracks, prior to actually starting recording, the amount of disk space available to record the current song will appear in the upper right corner of the display in approximate kilobytes. The measure number is displayed in this location when recording is started.

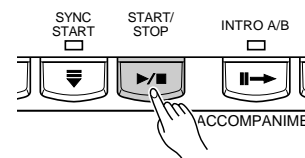

### 6 Stop recording.

Stop recording by pressing the [START/STOP] button or the [ENDING] button. When recording is stopped the "Saving the data" message will appear on the display while the recorded data is being saved to the disk.

## THE TRACK INDICATORS

The track indicators above the track mode selectors indicate which tracks contain data, which are set to REC, and which are muted, as shown to the right.

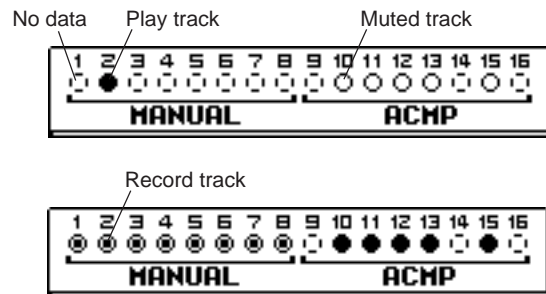

## TRACK DELETE

When the **DEL.** LCD button is pressed **DELETE** will appear for tracks which contain data. Select **DELETE** via the **MANUAL** or **ACMP** track LCD dials while holding the **DEL** button to delete all data in the corresponding tracks. The data is actually deleted when the **DEL.** LCD button is released. When the **DEL.** LCD button is pressed, tracks set to **REC** will automatically be switched to **PLAY** or **MUTE**.



## PLAYBACK

Recorded tracks are automatically set to the **PLAY** mode when recording is stopped, so you can simply press the **[START/STOP]** button to hear what you've recorded immediately after recording. All other playback functions are the same as described on the "Song Playback" section (page 100).

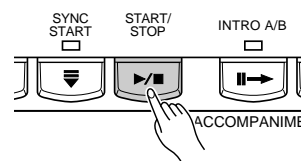

## EXITING

Press the **[SONG/M. PAD RECORDING]** or **[EXIT]** button to exit from the **QUICK RECORD** mode and return to the **RECORDING MENU** display.

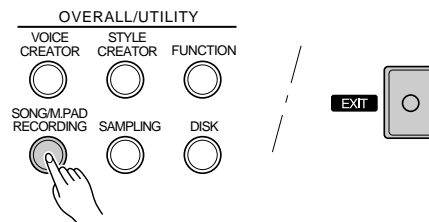



## Procedure: Chord Step Recording

The CHORD STEP recording feature makes it possible to record accompaniment chord changes one at a time with precise timing. Since the changes don't have to be entered in real time, it is easy to create even complex accompaniments before recording the melody.

Select the **CHORD STEP** display via the  or  LCD button to the right of the display in the QUICK RECORD mode.

### 1 Select an entry point.

Use the **CURSOR** LCD dials to position the cursor at the measure and beat at which you want to enter a chord or other accompaniment event. The largest  controls move the cursor in 8-measure steps, the medium  controls move the cursor in 1-measure steps, while the small  controls position the cursor in the smallest increment allowed for the current style. Measure numbers appear above each measure division on the "data line", and the smaller division represent the smallest increment available for the current style. The measure numbers will scroll accordingly when the cursor is moved past the last or first measure on the display (but not backwards past measure 1).



### 2 Specify a chord, volume change, or other event.

To specify a chord change use the **ROOT** and **TYPE** LCD dials to specify the chord. It is also possible to enter chords directly via the AUTO ACCOMPANIMENT section of the keyboard (but not when the FULL KEYBOARD or MANUAL BASS fingering mode is selected).

To specify a volume change use the **VOL.** LCD dial to specify the new volume level.

Other events which can be entered via the panel controls are: **STYLE** changes, **INTRO A/B**, **MAIN/AUTO FILL**, **ENDING** and **TEMPO** changes. **STYLE** change, **INTRO A/B**, and **ENDING** events can only be entered at the top of each measure. The edited event appears in inverse text in the event window near the lower right corner of the display.



### 3 Enter the specified event(s).

Once the event or events to be entered have been specified as described in the preceding step, press the **SET** LCD button to actually enter the event at the current cursor position. A dot will appear on the CHORD STEP data line and the cursor will advance to the top of the next beat (or appropriate point).

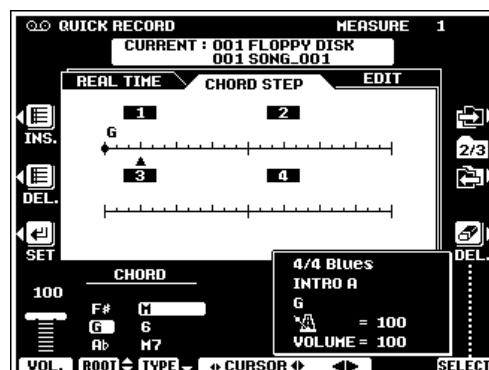

## 4 Repeat until done.

Repeat steps 1 through 3, above, until the required number of chord changes and other accompaniment events have been entered. The end of the sequence is automatically set at the end of an ENDING pattern, FADE OUT, one measure after the last measure containing data, or the insert point of an END event (available at the bottom of the CHORD TYPE list).

## DELETING EVENTS

When the cursor is located at any previously-entered dot on the CHORD STEP data line, the type of event(s) recorded in that location are indicated by triangular marker(s) to the left of the corresponding event names in the event window. When only one type of event has been entered at the cursor location an eraser icon appears to the right of the corresponding event in the event window, and that event can be erased simply by pressing the **DEL.** LCD button. When more than one type of event has been entered at the cursor location the **SELECT** LCD dial can be used to place the eraser icon next to any of these events, and the specified event can be erased by pressing the **DEL.** LCD button. Events at the top of a measure can be changed but not deleted.

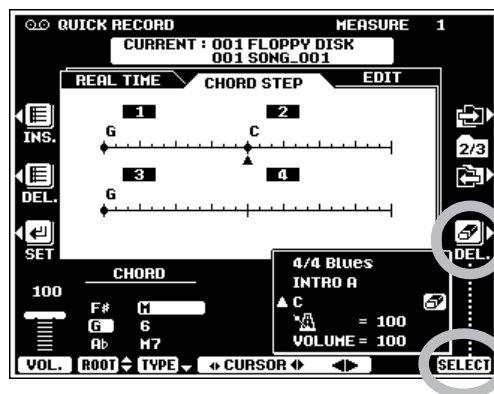

## INSERTING OR DELETING MEASURES

When the cursor is located at the first beat of a measure, a new (blank) measure can be inserted at that location by pressing the **INS.** LCD button to the left of the display.

An entire measure can be deleted by placing the cursor at the first beat of the measure to be deleted, and then pressing the **DEL.** LCD button to the left of the display.

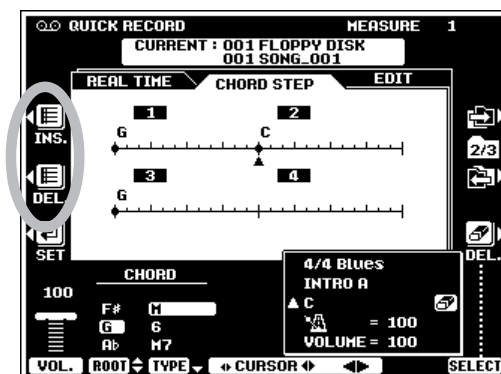

## SAVING THE CHORD STEP DATA

The entered CHORD STEP data is automatically saved to disk when you switch displays, press the **[EXIT]** button, or press the **[SONG/M.PAD RECORDING]** button.

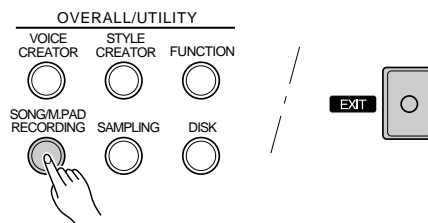

## Quick Record Mode Edit Functions

The QUICK RECORD mode **EDIT** display includes the RENAME SONG and SONG DELETE functions.

Select the **EDIT** display via the  LCD button to the right of the display.

### RENAME SONG

This function allows you to enter an original name for the current song. The name can be entered as described on page 21.



### SONG DELETE

This function deletes the specified song file from the disk.

Use the **DIRECTORY** dials to specify the FLOPPY DISK or HARD disk directory (if an optional hard is present). Use the **SONG DELETE** LCD dials to select the song to be deleted, Then press the **EXECUTE** LCD button.

**NOTE**

- The song currently being recorded cannot be deleted.
- The amount of disk space occupied by each song is displayed in approximate kilobytes in parentheses to the right of the song name.



## Procedure: Multi Track Record

The MULTI TRACK record mode allows independent recording and playback on any of 16 tracks, so even complex songs can be built up track by track.

### 1 Set the track modes.

Use the **TR1** through **TR16** LCD dials to select the REC mode for the track(s) to be recorded, the PLAY mode for the tracks to be played while recording, or the MUTE mode for tracks neither to be played or recorded. The PLAY mode can only be selected for tracks which contain data. The **TR1~8** or **TR9~16** LCD button selects track groups 1 through 8 and 9 through 16, respectively.

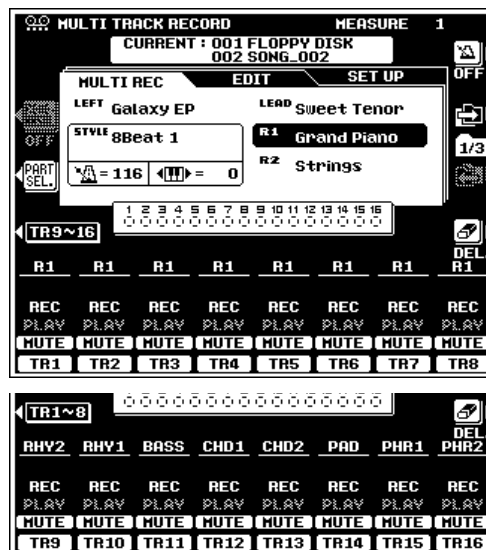

## 2 Change the track parts, if required. ....

The default part for each track is displayed above the REC setting. The parts can be changed as required by pressing the **PART SEL.** LCD button (the part names for each track will be highlighted), selecting the desired parts via the corresponding LCD dials (see list below). When the parts have been changed, press the **REC SEL.** LCD button (the **PART SEL.** LCD button will have changed to the **REC SEL.** LCD button) again to return to the normal track setup mode.



The available parts for all tracks are:

LEAD	AUTO ACCOMPANIMENT (BASS)
RIGHT1	AUTO ACCOMPANIMENT (CHORD 1)
RIGHT 2	AUTO ACCOMPANIMENT (CHORD 2)
LEFT	AUTO ACCOMPANIMENT (PAD)
MULTI PAD 1 ... 4	AUTO ACCOMPANIMENT (PHRASE 1)
RHYTHM 1	AUTO ACCOMPANIMENT (PHRASE 2)
RHYTHM 2	MIDI (see "NOTE", below)
	VOCAL (see "NOTE", below)

### NOTE

- When the MIDI "part" is selected (only effective when the MIDI receive mode is set to "XG/GM" via the F9: MIDI functions — page 136) all received MIDI data will be recorded on the corresponding track. If only one track is set to MIDI, data received on all channels will be recorded to that track. If 2 or more tracks are set to MIDI, MIDI data will be received on the correspondingly numbered MIDI channels (i.e. track 1 = MIDI channel 1, track 2 = MIDI channel 2, etc.).
- When VOCAL is selected the VOCAL HARMONY on/off, type, and parameter settings are recorded. Note data for the VOCAL HARMONY Vocoder type harmony notes can be recorded when the VOCAL HARMONY feature is on, the Vocoder type is selected, and the harmony part parameter is not turned off. Note data recorded in this way only affects the VOCAL HARMONY sound, and does not actually play the PSR-8000 voices. The recorded volume, pan, detune, modulation, and pitch bend data will also affect the harmony notes for any VOCAL HARMONY type during playback.

## 3 Set up for the recording. ....

Select the required voice(s), select a style, turn AUTO ACCOMPANIMENT on if required. Set up all parameters as desired for recording.

The FADER and FULL **MIXING CONSOLE** displays can be used to set the initial values of the available parameters prior to recording. The FADER and FULL **MIXING CONSOLE** buttons alternately select the MAIN and ACMP **MIXING CONSOLE** displays (except in the FULL **MIXING CONSOLE EFFECT TYPE, TUNING, and MASTER EQ** displays). In the FADER MIXING CONSOLE both the **VOLUME** and **PART SWITCH** displays are available. In the FULL MIXING CONSOLE the **VOLUME/PAN/EQ, FILTER, EFFECT DEPTH, EFFECT TYPE** and **TUNING** displays include recordable pa-





rameters. In the MULTI TRACK RECORD mode the initial values for the independent tracks can also be changed as required after recording via the **SET UP** display (page 118).

Use the metronome-icon LCD button to turn the metronome ON if you want to record while monitoring the metronome sound (the metronome sound is not recorded), or OFF if you don't want to hear the metronome while recording.

**NOTE**

- If you turn the panel [AUTO ACCOMPANIMENT] button on, all accompaniment tracks will automatically be set to the REC mode.
- If the panel [AUTO ACCOMPANIMENT] button is turned off the accompaniment track REC modes will be disengaged.
- If no AUTO ACCOMPANIMENT track is set to the REC mode, the [AUTO ACCOMPANIMENT] button will automatically be turned off.
- If the REC mode is engaged for any of the accompaniment tracks other than RHY1 and RHY2, the panel [AUTO ACCOMPANIMENT] button will be turned on automatically.



## 4 Start recording.

Engage the SYNC START mode if you want to start recording automatically as soon as you start playing on the keyboard. Otherwise use the panel [START/STOP] button.

**NOTE**

- Any previous data in a track will be erased when that track is recorded.
- Changes made to the recordable FADER and FULL MIXING CONSOLE parameters will be recorded.
- When the record mode is engaged for any tracks, prior to actually starting recording, the amount of disk space available to record the current song will appear in the upper right corner of the display in approximate kilobytes. The measure number is displayed in this location when recording is started.

## 5 Stop recording.

Stop recording by pressing the panel [START/STOP] button or the [ENDING] button. When recording is stopped the “Saving the data” message will appear on the display while the recorded data is being saved to the disk.

## THE TRACK INDICATORS

The track indicators above the track mode selectors indicate which tracks are set to REC, which contain data, and which are muted, as shown to the right.

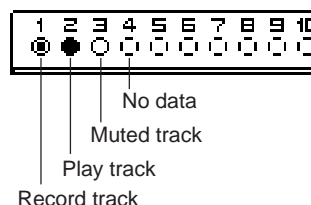

## TRACK DELETE

When the **DEL.** LCD button is pressed **DELETE** will appear for tracks which contain data. Select **DELETE** via the **TR1** through **TR16** LCD dials while holding the **DEL.** button to delete all data in the corresponding tracks. The data is actually deleted when the **DEL.** LCD button is released. When the **DEL.** LCD button is pressed, tracks set to **REC** will automatically be switched to **PLAY** or **MUTE**.



## PLAYBACK

Recorded tracks are automatically set to the **PLAY** mode when recording is stopped, so you can simply press the **[START/STOP]** button to hear what you've recorded immediately after recording. All other playback functions are the same as described on the "Song Playback" section (page 100).

## EXITING

Press the **[SONG/M. PAD RECORDING]** or **[EXIT]** button to exit from the **MULTITRACK RECORD** mode and return to the **RECORDING MENU** display.

## Procedure: Punch-In & Replace Recording

In addition to the normal recording procedure described above, the PSR-8000 also has a **REPLACE** record mode which allows normal recording to be carried out from a specified measure, and a **PUNCH IN** record mode which allows only a section of a recorded track to be re-recorded without having to redo the entire track. The **REPLACE** or **PUNCH IN** record mode can be selected via the record mode display accessed by pressing the **REC MODE** LCD button in the main **MULTI TRACK RECORD** display. The **REC MODE** button is only available when the current song contains some previously recorded data.

### 1 Go to the REC MODE display.

Press the **REC MODE** LCD button to go to the record mode display.

### 2 Select the PUNCH IN or REPLACE record mode & related parameters.

#### ● PUNCH IN

Use the **RECORD MODE** LCD dials to select **PUNCH IN**. Use the **PUNCH IN TRIGGER** LCD dials to select the **FIRST KEY ON**, **FOOT SW 1**, **FOOT SW 2**, or **AUTO SET** start trigger. When **FIRST KEY ON** is selected recording will begin



when the first key is played on the keyboard. When FOOT SW 1 or FOOT SW 2 is selected recording will begin when a footswitch connected to the corresponding rear-panel FOOT SWITCH jack is pressed. When AUTO SET is selected, the punch-in and punch-out measures are specified by the **IN** and **OUT** LCD dials (i.e. recording begins automatically at the IN measure and ends at the OUT measure).

Use the **MEASURE SET** dials to specify the first playback measure. Be sure to give yourself a few measures “lead-in” prior to the actual punch-in point.

**NOTE**

- If a measure is specified beyond the last measure which contains data, the last measure which contains data will automatically be selected.

● **REPLACE**

Use the **RECORD MODE** LCD dials to select REPLACE.

Use the **MEASURE SET** LCD dials to specify the measure you want to start recording from.



### 3 Return to the main recording display and record.

Press the **OK** LCD button to confirm the record mode settings and return to the main **MULTI TRACK RECORD** display. Or press the **CANCEL** LCD button to return without making any changes.

● **PUNCH IN**

Use the **TRACK** LCD dials to select a track (or tracks) for PUNCH IN recording. Press the **[START/STOP]** button to start playback from the specified measure, then record at the punch-in point according to the selected PUNCH IN TRIGGER mode (set in the previous step).

When the PUNCH IN mode has been selected a **RE-HEARSAL** LCD button will appear in the main **MULTI TRACK RECORD** display. This can be turned “ON” to allow rehearsing the punch-in without actually recording any data. Turn the REHEARSAL function “OFF” when you’re ready to do the actual recording.

● **REPLACE**

Follow the normal recording procedure described in the previous section. The only difference is that recording will begin from the measure specified in the **REC MODE** display, and all data from that point to the end of the song will be replaced by the newly-recorded material.

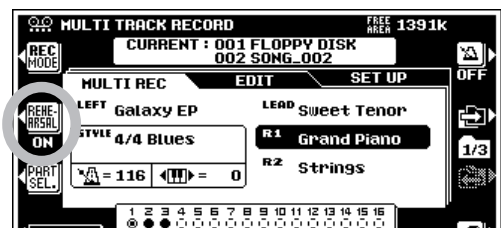

**NOTE**

- REPLACE or PUNCH IN recording cannot be used on tracks to which rhythm and/or AUTO ACCOMPANIMENT data has been recorded. To re-record such tracks the REC MODE must be set to REPLACE and the MEASURE SET parameter must be set to “1” (this is the normal MULTI TRACK RECORD mode).

### 4 Stop recording.

If the FIRST KEY ON, FOOT SW 1, or FOOT SW 2 trigger mode was used, stop recording at the punch-out point by pressing the panel **[START/STOP]** button or the footswitch if a FOOT SW mode was selected. If the AUTO SET trigger was used, recording will stop automatically at the specified OUT measure.

**NOTE**

- The record PUNCH IN or REPLACE mode remains active after recording, but the measure number reverts to 1.

## Multi Track Record Mode Edit Functions

The MULTI TRACK RECORD mode **EDIT** display includes the following functions:

<b>RENAME SONG</b> .....	116
<b>QUANTIZE</b> .....	116
<b>TRACK MIX</b> .....	117
<b>NOTE SHIFT</b> .....	117
<b>SONG DELETE</b> .....	117

Select the **EDIT** display via the  LCD button to the right of the display, then use the **▲** and **▼** LCD buttons to the left of the display to select the desired function.

### RENAME SONG .....

This function allows you to enter an original name for the current song. Enter the name as described on page 21, then press the **EXECUTE** LCD button.



### QUANTIZE .....

The **QUANTIZE** function aligns recorded notes in a specified track to the specified beats to “tighten up” the timing of a performance.

Use the **TRACK** LCD dials to select the track to be quantized, and the **SIZE** LCD dials to select the beats to which the notes will be aligned. Only tracks which contain data will be available for quantization.

The **STRENGTH** dials determine how “strongly” the notes will be quantized. If a value less than “100%” is selected, notes will be moved toward the specified quantization beats only by the specified amount.

Press the **EXECUTE** button to quantize the data. “**Executing**” will appear on the display while the data is being quantized. After quantization the **EXECUTE** button changes to an **UNDO** button which can be used to undo the quantize operation if the results are not satisfactory (the “**UNDO**” button will only remain active until the next operation is performed).



The quantize sizes are:

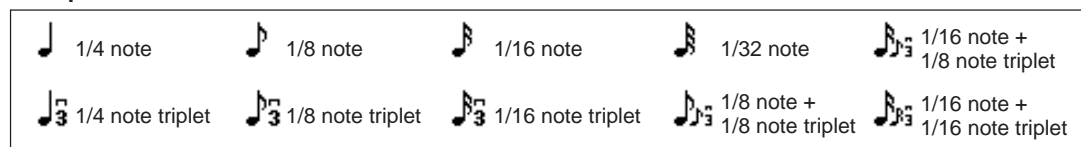

## TRACK MIX

This function allows data from two tracks can be mixed and the results placed in a different track, or data to be copied from one track to another.

Use the **SOURCE1** and **SOURCE2** LCD dials to specify the tracks to be mixed, and the **DESTINATION** LCD dials to select the track into which the results will be placed. To simply copy from the SOURCE1 track to the DESTINATION track select **COPY** via the **SOURCE2** LCD dials.

Press the **EXECUTE** button. “Executing” will appear on the display while the data is being copied. After execution the **EXECUTE** button changes to an **UNDO** button which can be used to undo the copy/mix operation if the results are not satisfactory (the “UNDO” button will only remain active until the next operation is performed).



### NOTE

- All data other than the mixed note data is derived from the SOURCE1 track.

## NOTE SHIFT

Allows tracks which contain data to be individually transposed up or down by a maximum of two octaves in semitone increments.

Use the LCD dials to set the desired amount of transposition for each track (note-shift controls will only appear for tracks which contain data). The **TR1 ~ 8/TR9 ~ 16** LCD button can be used to switch between tracks 1 through 8 and tracks 9 through 16. Adjust any track while holding the **ALL TRACKS** LCD button to set the note shift for all tracks simultaneously.

Press the **EXECUTE** button. “Executing” will appear on the display while the data is being processed. After execution the **EXECUTE** button changes to an **UNDO** button which can be used to undo the note shift operation if the results are not satisfactory (the “UNDO” button will only remain active until the next operation is performed).



## SONG DELETE

This function deletes the specified song file from the disk.

Use the **DIRECTORY** dials to specify the FLOPPY DISK or HARD disk directory (if an optional hard is present). Use the **SONG DELETE** LCD dials to select the song to be deleted, Then press the **EXECUTE** LCD button.

### NOTE

- The song currently being recorded cannot be deleted.
- The amount of disk space occupied by each song is displayed in approximate kilobytes in parentheses to the right of the song name.



## Multi Track Record Set Up

The MULTI TRACK RECORD mode **SET UP** display includes the VOICE function, and other parameters can be set up as required via the **MIXING CONSOLE** displays.

Select the **SET UP** display via the  LCD button to the right of the display.

### VOICE

This function can be used to change the voices assigned to any of the current song's tracks.

Use the **TRACK** LCD dials to select the track to which a new voice is to be assigned. Use the **CATEGORY** and **VOICE** LCD dials to select the voice to be assigned to the selected track.

Press the **EXECUTE** LCD button to register the voice selection.

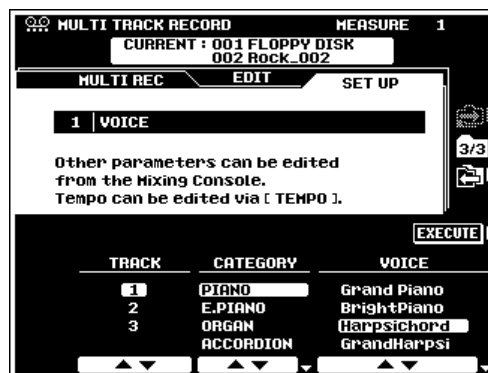

### OTHER SET UP PARAMETERS

While the **SET UP** display is selected the tempo of the song can be set as required via the **TEMPO** controls, and all other available parameters can be modified as required via the **MIXING CONSOLE** displays. The **FADER MIXING CONSOLE** provides access to individual volume faders for each track, and the **FULL MIXING CONSOLE VOLUME/PAN/EQ, FILTER, EFFECT DEPTH** and **EFFECT TYPE** displays provide access to a range of other parameters. Parameters not available in the **FULL MIXING CONSOLE** displays are indicated by “---” in the value location. The **[FADER]** and **[FULL]** buttons sequentially switch between the normal parts, song tracks TR1—TR8, and song tracks TR9—TR16 (except for the **FULL MIXING CONSOLE EFFECT TYPE** display). The **FADER** and **FULL** normal part parameters can be changed for playback but they cannot be recorded. The same applies to the **FADER PART SWITCH** parameters and the **FULL MIXING CONSOLE TUNING** and **MASTER EQ** displays.

After adjusting the **SET UP** parameters as required, press the **EXECUTE** LCD button to record the changes to the TR1—TR8 and TR9—TR16 parameters as initial values for the corresponding tracks.

# The Multi Pads

The PSR-8000 features 4 “MULTI PADS” that can be used to record and play back short sequences of notes and chords. The multi pads can be used to add phrases and sound effects as you play, they can be used to supplement the AUTO ACCOMPANIMENT feature with extra phrases and fills, or when the REPEAT mode is on they can function as an extra style track, providing automatic arpeggios and other embellishments.

There are 60 MULTI PAD “banks”, each of which includes the four MULTI PAD buttons. Banks 01 through 50 contain preset phrases, and banks 51 through 60 are “user” banks in which you can record your own phrases.

## MULTI PAD Playback

Use the M.PAD BANK [-] and [+] buttons to select the desired bank, then press one of the MULTI PAD buttons — [1] ... [4] — to play the corresponding phrase. The phrase will play back whether the accompaniment is playing or not, but will always play at the currently set tempo. Unless the REPEAT mode is on for the selected pad (page 121), playback will end automatically as soon as the end of the phrase is reached. A phrase can be stopped while it is playing by pressing the MULTI PAD [STOP] button. A currently playing phrase can be retriggered by pressing the corresponding pad button. It is also possible to play back several phrases at the same time.

If a MULTI PAD is played while AUTO ACCOMPANIMENT is playing and the CHORD MATCH function for that pad is ON (see “The Repeat & Chord Match Modes”, below), the phrase will be automatically re-harmonized to match the accompaniment chords.

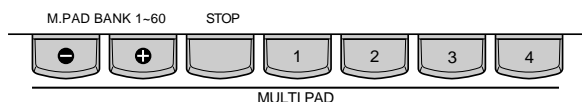

### NOTE

- Use the M.PAD controls in the FADER and FULL MIXING CONSOLE displays to adjust the playback volume and other aspects of the MULTI PAD sound.
- Although new phrases cannot be recorded to banks 1 through 50, the CHORD MATCH and REPEAT modes can be set as desired for these banks as well as the user banks (page 121).



## Procedure: MULTI PAD Recording

### 1 Go to the MULTI PAD RECORD display. ....

Press the [SONG/M. PAD RECORDING] button to go to the **RECORDING MENU**, and then the **MULTI PAD RECORDING** LCD button to go to the **MULTI PAD RECORD** display. You can return to the previous display by pressing the [SONG/M. PAD RECORDING] button again, or by pressing the [EXIT] button.



## 2 Select a bank and pad.

Make sure the **RECORDING/CLEAR** display page **RECORDING** function is selected. Use the **BANK** and **PAD SELECT** LCD dials to select the bank/pad you want to record (only banks 51 through 60 are recordable). You can also use the panel **M.PAD BANK [-]** and **[+]** buttons to select the desired bank, and the **MULTI PAD** buttons — **[1] ... [4]** — to select the desired pad. The amount of **FREE AREA** for the entire **MULTI PAD** recording memory is displayed in the upper right corner of the display.

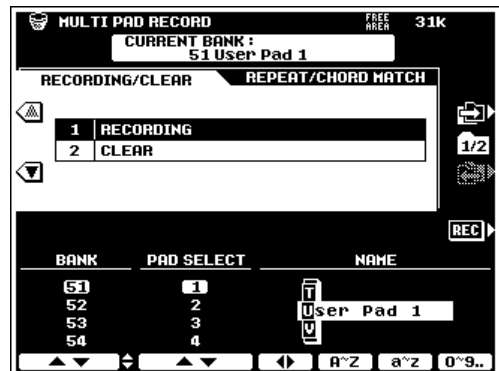

## 3 Select a style.

Select the style you want to play along with while recording your **MULTI PAD** phrase. The selected style will play during **MULTI PAD** recording (it will not be recorded). The **MULTI PAD** phrase will be recorded in relation to the current accompaniment tempo. If you don't want to hear the style while recording, use the **FADER MIXING CONSOLE ACMP** fader to turn the accompaniment volume all the way down.

## 4 Engage the REC WAITING mode.

Press the **REC** LCD button. It will change to the **REC WAITING** button, the **SYNC START** mode will be engaged, the first LED of the **BEAT** indicator will flash at the current tempo, and the **RIGHT 1** part will be selected (the **MULTI PADS** only record the **RIGHT 1** voice). Select a different **RIGHT 1** voice if you want to change the **MULTI PAD** sound.



## 5 Record.

Recording begins automatically as soon as you play on the keyboard. Record along with the selected style.

### NOTE

- Only one voice can be recorded to the each pad.
- When a pad is recorded all previous data in that pad will be erased and replaced by the new data.
- Phrases you intend to use with the **CHORD MATCH** function ("The Repeat and Chord Match Modes", below) should be recorded in the key of **CM7**.

## 6 Stop Recording

Press the **STOP** LCD button or the panel **MULTI PAD [STOP]** button to stop recording when you've finished playing the phrase.

### NOTE

- The **MULTI PADS** are recorded in 1-measure increments.
- **MULTI PAD** data can be saved to and loaded from disk (pages 140, 141).

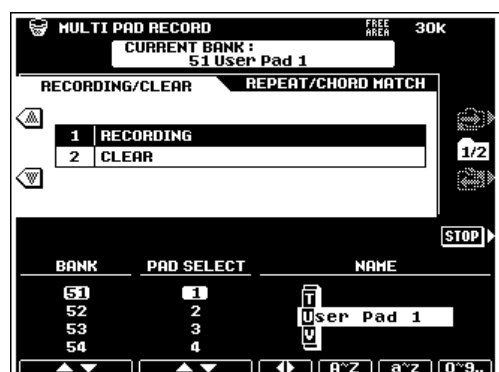



## MULTI PAD NAME

The **MULTI PAD RECORD RECORDING/CLEAR** display includes **NAME** parameters which can be used to enter names for any of the user MULTI PAD banks (51 through 60). Enter the name as described on page 21.

## MULTI PAD CLEAR

While in the **MULTI PAD RECORD RECORDING/CLEAR** display press the **▼** LCD button to the left of the display to access the MULTI PAD CLEAR function.

Use the **BANK** and **PAD** LCD dials to select the bank/pad you want to clear (only banks 51 through 60 can be cleared). You can also use the panel M.PAD BANK [-] and [+] buttons to select the desired bank, and the MULTI PAD buttons — [1] ... [4] — to select the desired pad.

Press the **BANK CLEAR** LCD button to clear all four pads in the currently selected bank, or the **PAD CLEAR** LCD button to clear only the currently selected pad.

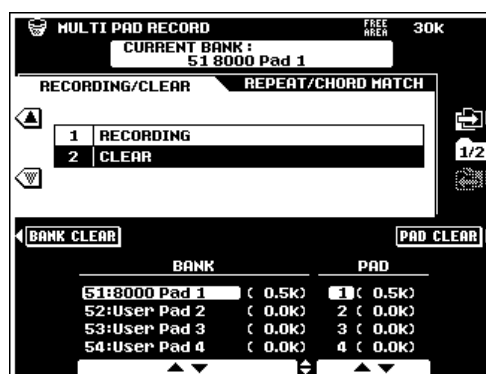
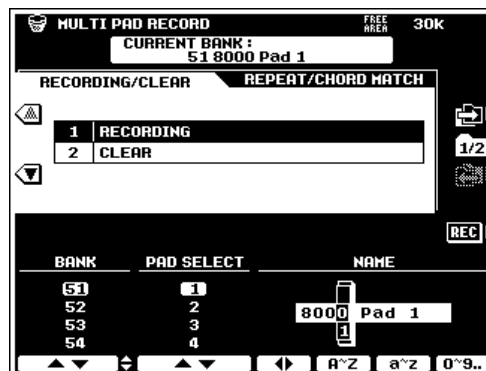

## The Repeat & Chord Match Modes

The MULTI PAD REPEAT and CHORD MATCH settings can be accessed by pressing the **☰** LCD button in the **MULTI PAD RECORD** display. Then use the **▲** and **▼** LCD buttons to the left of the display to select the **REPEAT** and **CHORD MATCH** parameters, as required. These settings can be applied to the preset and user MULTI PAD banks.

### REPEAT

When a check mark appears in a **REPEAT** box, the corresponding pad will playback repeatedly until stopped by pressing the [STOP] button.

Use the **BANK** LCD dials to select the desired bank, and the **REPEAT** LCD dials to turn repeat for the corresponding pads ON or OFF as required.

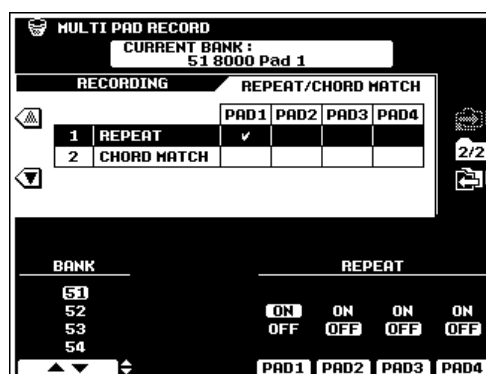

### CHORD MATCH

When a check mark appears in a **CHORD MATCH** box, the phrase played by the corresponding pad will be automatically re-harmonized to match the accompaniment chords if played while **AUTO ACCOMPANIMENT** is playing.

Use the **BANK** LCD dials to select the desired bank, and the **CHORD MATCH** LCD dials to turn chord matching for the corresponding pads ON or OFF as required.

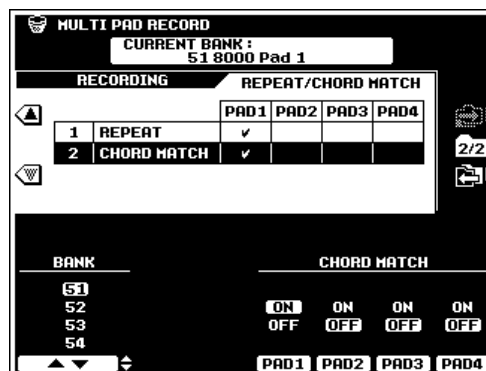

# The PSR-8000 "Functions"





The PSR-8000 "FUNCTION" mode includes 9 groups of functions that access a number of parameters related to overall PSR-8000 operation.

## The FUNCTION Parameters

Here's a list of the functions and the manual page numbers on which they are described in detail.

<b>[F1] MASTER TUNE / SCALE</b> .....	123
<b>[F2] SPLIT POINT / FINGERING</b> .....	123
<b>[F3] CONTROLLER</b> .....	124
<b>[F4] REGISTRATION / ONE TOUCH SETTING / VOICE SET</b> .....	127
<b>[F5] HARMONY / ECHO</b> .....	129
<b>[F6] CUSTOMIZE LIST</b> .....	129
<b>[F7] TALK SETTING</b> .....	130
<b>[F8] UTILITY</b> .....	131
<b>[F9] MIDI</b> .....	132

Press the [FUNCTION] button to engage the function mode, then press the LCD button corresponding to the desired function group.

Each of the FUNCTION pages can be selected via the  and  LCD buttons to the right of the display, and the various parameters or groups of parameters in each display page can be accessed via the  and  LCD buttons. In all cases the selected parameter can be edited via the appropriately labeled or positioned LCD dials.

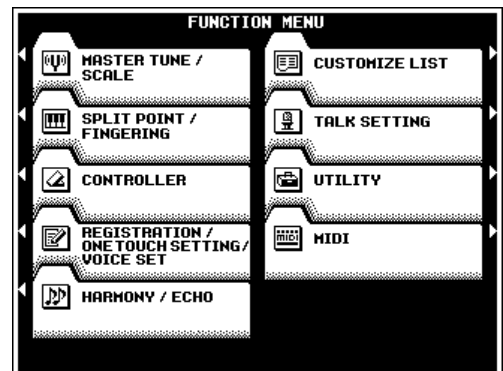

### The [EXIT] Button .....

The [EXIT] or [FUNCTION] button can be used at any time to exit from a function and return to the function menu. Pressing the [EXIT] or [FUNCTION] button while the FUNCTION MENU is showing will return you to the normal play mode.

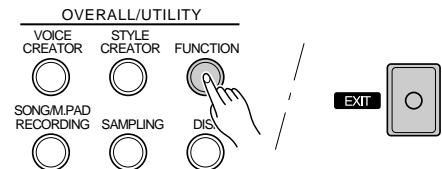

## F1: MASTER TUNE/SCALE

Both master tuning and Arabic scale tuning functions are included in the F1 function group.

### MASTER TUNE

Tunes the overall pitch of the PSR-8000 referenced to the A3 key from 414.6 Hz to 466.8 Hz. A3 = 440 Hz is standard "concert" pitch.

### SCALE (ARABIC)

Selects either the normal equal temperament scale or an "arabic" scale in which each note can be tuned over a 127-cent range.

Use the **SCALE** LCD dials to select either the EQUAL TEMPERAMENT or ARABIC scale.

When the ARABIC scale is selected you can use the **TUNE NOTE** LCD dials to select the note you want to tune (the selected note will be highlighted in the graphic keyboard in the upper section of the display), then use the large **▲** and **▼** LCD dial to coarse-tune the selected key in 25-cent steps, and the small **▲** and **▼** LCD dial to fine-tune the selected note in 1-cent steps. The tuning range is from "-64" through "0" to "+63". Each increment equals one cent (one "cent" is one hundredth of a semitone). The current tuning of each note is shown in the corresponding key of the graphic keyboard display.

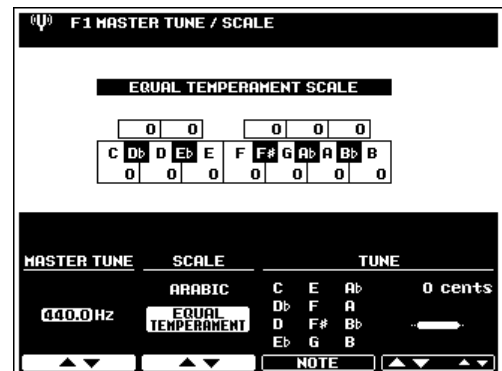

## F2: SPLIT POINT/FINGERING

The F2 functions both pertain to the PSR-8000's AUTO ACCOMPANIMENT feature — i.e. the accompaniment split point and the accompaniment fingering mode.

### SPLIT POINT

The PSR-8000 has two programmable split points — one which divides the LEFT and RIGHT/LEAD parts (page 22), and one which divides the auto-accompaniment and manual sections of the keyboard when AUTO ACCOMPANIMENT is engaged (page 28). The former is indicated by the "L" marker and the latter by the "A" marker above the graphic keyboard. The current split points are indicated on the display both by the split markers and the "splits" in the graphic keyboard.

The split points can be set in two ways: either use the **SPLIT POINT A** and **SPLIT POINT L** LCD dials, or press the desired key on the keyboard while holding the **A** or **L DIRECT SETTING** LCD button. The new split point will be indicated on the graphic keyboard in the LCD.

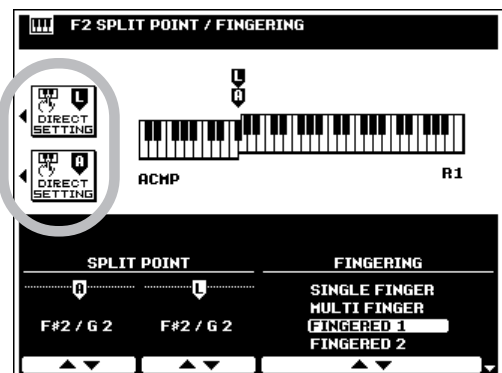

#### NOTE

- The "L" split point cannot be set lower than the "A" split point.
- When the "L" and "A" split points are set at different keys, the LEFT voice can be played between the "A" and "L" split points when the AUTO ACCOMPANIMENT function is on. When the "L" and "A" split points are set to the same key, the LEFT voice can be played anywhere to the left of the "L" and "A" split points.
- When AUTO ACCOMPANIMENT is on, a fingering mode other than FULL KEYBOARD is selected, and "L" and "A" are set at the same key, The LEFT voice will not become MONO even if the MONO mode is selected.

## FINGERING

Use the **FINGERING** LCD dials to select the SINGLE FINGER, MULTI FINGER, FINGERED 1, FINGERED 2, FULL KEYBOARD, or MANUAL BASS mode. See the descriptions on page 30 for details on the operation of each mode.

## F3: CONTROLLER

The F3 function group includes a range of functions that affect how the PSR-8000 responds to control via a foot controller plugged into the rear-panel **FOOT PEDAL VOLUME** jack, footswitches plugged into the rear-panel **FOOT PEDAL SWITCH** jacks, the **MODULATION** wheel, initial keyboard touch response, and aftertouch response.

### FOOT CONTROLLER

#### ● VOLUME

Determines whether an optional YAMAHA FC7 Foot Controller plugged into the rear-panel **FOOT PEDAL VOLUME** jack will control master volume, or only the volume of specified parts and voices.

Use the **MASTER/INDIVIDUAL** LCD button to select **MASTER** for master volume control or **INDIVIDUAL** for individual part/voice volume control.

Individual part and voice assignment parameters for the **SONG**, **ACMP**, **M.PAD**, **LEFT**, **R1**, **R2**, **LEAD**, and **MIC** (microphone) parts are available when the **INDIVIDUAL** type is selected. Use the corresponding LCD dials to turn volume control for the corresponding parts **ON** or **OFF** as required.

#### NOTE

- Normally you'll want to be able to apply expression control to the manual voices without affecting the accompaniment and rhythm sound, so the **INDIVIDUAL** type should be selected and the voices you want to control turned on while the remaining parts are turned off.

#### ● SW1 (FOOTSWITCH 1) & SW2 (FOOTSWITCH 2)

Determine the functions of footswitches plugged into the rear-panel **FOOT PEDAL SWITCH 1** and **FOOT PEDAL SWITCH 2** jacks, and to which of the PSR-8000 voices the footswitches will apply.

Use the **TYPE** LCD dials to select one of the footswitch functions listed below. When the **SUSTAIN**, **SOSTENUTO**, **SOFT**, **GLIDE**, **PORTAMENT**, or **DSP VARIATION** type is selected, use the **LEFT**, **R1**, **R2**, and **LEAD** LCD dials (R1, R2, and LEAD when **DSP VARIATION** is selected) to turn footswitch control for the corresponding parts **ON** or **OFF** as required.

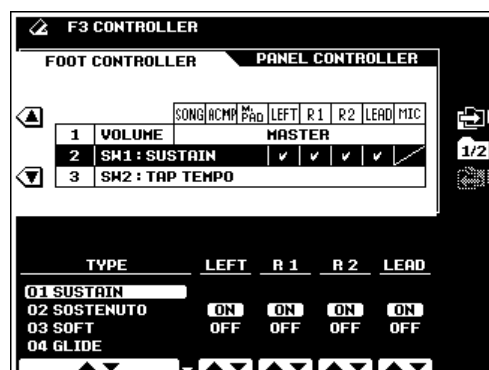
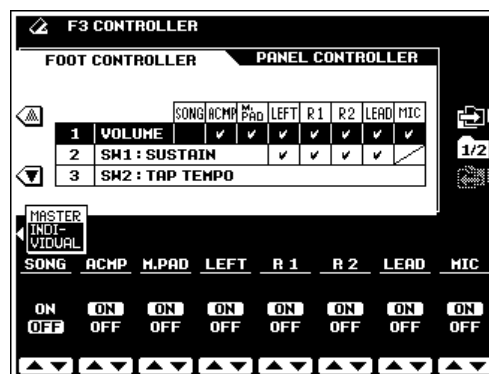
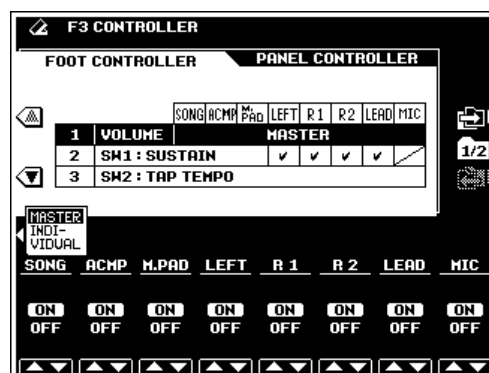

<b>SUSTAIN</b>	Standard sustain footswitch operation. When the footswitch is pressed notes played have a long sustain. Releasing the footswitch immediately stops (damps) any sustained notes.
<b>SOSTENUTO</b>	If you play a note or chord on the keyboard and press the footswitch while the note(s) are held, those notes will be sustained as long as the footswitch is held (as if the damper pedal had been pressed) but all subsequently played notes will not be sustained. This makes it possible to sustain a chord, for example, while other notes are played "staccato."
<b>SOFT</b>	Pressing the footswitch subtly reduces the volume and slightly changes the timbre of notes played. The SOFT effect only applies to certain voices — PIANO, for example.
<b>GLIDE</b>	When the pedal is pressed the pitch drops a semitone, and then glides smoothly back to normal pitch when the pedal is released.
<b>PORTAMENT</b>	The portamento effect (a smooth slide between notes) can be produced while the pedal is pressed. Portamento is produced when notes are played legato style (i.e. a note is played while the preceding note is still held). The portamento time can be set via the FULL MIXING CONSOLE TUNING display (page 44).
<b>DSP VARIATION</b>	Same as the panel [DSP VARIATION] button.
<b>HARMONY/ECHO</b>	Harmony occurs only while pedal pressed.
<b>VOCAL HARMONY</b>	Same as the panel [VOCAL HARMONY(8)] button.
<b>REGIST. +</b>	Recall next highest (increment) registration. "1-1" is selected after "16-8".
<b>REGIST. -</b>	Recall next lowest (decrement) registration. "16-8" is selected after "1-1".
<b>START/STOP</b>	Same as panel [START/STOP] button.
<b>TAP TEMPO</b>	While the accompaniment is stopped, or during the SYNCHRO START mode before the accompaniment is started, the footswitch can be used to start the accompaniment at any desired tempo (within the PSR-8000's 32 to 280 beats per minute range) by simply tapping on the switch at the required tempo. Tap 4 times for an accompaniment with a 4/4 time signature, 3 times for 3/4, and 5 times for 5/4. The Tap Start setting will be ignored if several seconds elapse before the required number of taps have been entered. The TAP TEMPO function can also be used to change the tempo during accompaniment playback: tap the pedal twice at the required tempo. In this case the tap "click" will not sound.
<b>SYNCHRO STOP</b>	Same as the panel [SYNC STOP] button.
<b>INTRO</b>	Same as panel [INTRO A/B] button.
<b>FILL IN TO A</b>	Same as the panel MAIN/AUTO FILL [A] button.
<b>FILL IN TO B</b>	Same as the panel MAIN/AUTO FILL [B] button.
<b>ENDING/rit.</b>	Same as panel [ENDING/rit.] button.
<b>FADE IN/OUT</b>	Same as panel [FADE IN/OUT] button.
<b>F.CHORD 1/2</b>	The footswitch alternately switches between the FINGERED 1 and FINGERED 2 modes (pages 31, 32).
<b>BASS HOLD</b>	While the pedal is pressed the AUTO ACCOMPANIMENT bass note will be held even if the chord is changed. This function does not work in the FULL KEYBOARD or MANUAL BASS mode.
<b>PERCUSSION</b>	Footswitch plays a percussion instrument selected by the ASSIGN LCD dials (the latter appears when the PERCUSSION type is selected).

 **NOTE**

- When the SUSTAIN or SOSTENUTO footswitch functions are being used, some voices may sound continuously or have a long decay after the notes have been released while the footswitch is held.

## PANEL CONTROLLER

### ● MODULATION WHEEL

Determines to which of the PSR-8000 voices the **MODULATION** wheel will apply.

Use the **LEFT**, **R1**, **R2**, and **LEAD** LCD dials to turn **MODULATION** wheel control for the corresponding parts ON or OFF as required.

### ● INITIAL TOUCH

Sets the touch response off-level and sensitivity curve of the keyboard initial touch response, and determines to which of the PSR-8000 voices touch response will apply.

Use the **OFF LEVEL** LCD dial to set the level at which touch response is turned off.

Use the **SENSITIVITY** LCD dials to select the desired sensitivity curve.

<b>HARD 2</b>	Requires the keys to be played very hard to produce maximum loudness.
<b>HARD 1</b>	Requires the keys to be played quite hard to produce maximum loudness.
<b>NORMAL</b>	Produces a fairly "standard" keyboard response.
<b>SOFT 1</b>	Not a sensitivity as the "SOFT 2" setting, but maximum loudness can still be easily produced with relatively light key pressure.
<b>SOFT 2</b>	Allows maximum loudness to be produced with very light key pressure.

Use the **LEFT**, **R1**, **R2**, and **LEAD** LCD dials to turn initial touch response control for the corresponding parts ON or OFF as required.

### ● AFTER TOUCH

Aftertouch effects are preset for many of the PSR-8000's voices (some voices have no aftertouch). This parameter sets the keyboard aftertouch sensitivity. Use the **SENSITIVITY** LCD dials to select the desired sensitivity. When the **SOFT** type is selected maximum variation can be produced with minimum aftertouch pressure.

Use the **LEFT**, **R1**, **R2**, and **LEAD** LCD dials to turn aftertouch for the corresponding parts ON or OFF as required.

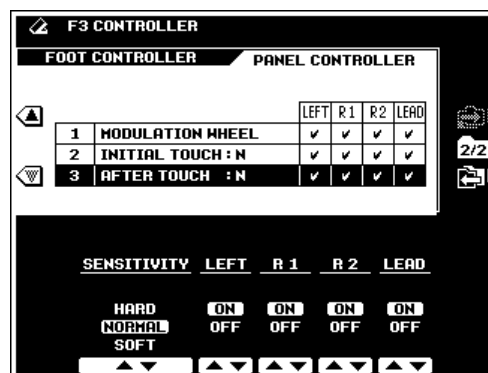
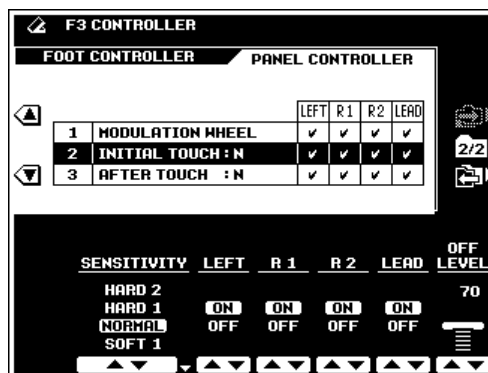
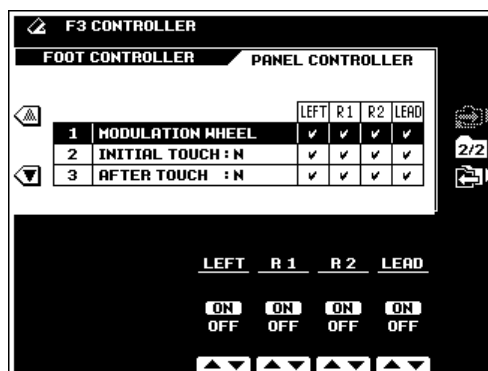

## F4: REGISTRATION/ONE TOUCH SETTING/VOICE SET

### REGISTRATION

#### ● NAME

You can enter descriptive names for each registration setup via the NAME function. The name entered is applied to the currently selected registration setup.

If necessary, begin by selecting the desired registration bank and number. The name can be entered as described on page 21.

Press the **OVERVIEW** LCD button to see an "overview" of which voices are assigned to which parts, and the selected **STYLE** or **SONG**. The **BANK** and **NUMBER** LCD dials are available in the overview display. Press the **RETURN** LCD button to return to the normal **REGISTRATION** display.

#### NOTE

- It's a good idea to give your registration setups names that make them easily identifiable. If you've created a registration setup for a song named "MySong", a good registration name might be something like "MySong-Reg".

#### ● FREEZE GROUP SETTING

You can specify which settings are affected by the FREEZE function (page 47) via the FREEZE GROUP SETTING function.

Use the **GROUP SELECT** LCD dials to select a setting you want to freeze or "un-freeze", then use the **MARK** LCD dial to set or remove the check mark for that setting. Repeat until all settings are marked or un-marked as required. The parameters included in each group are listed on page 171.

### ONE TOUCH SETTING

#### ● CUSTOM OTS (One Touch Setting)

The **OTS** LCD dial selects the CUSTOM OTS setup to be edited (setups which contain no data cannot be selected). The **STYLE** to which the selected CUSTOM OTS is assigned is displayed to the right.

The **STYLE CATEGORY** and **▲/▼** LCD dials can be used to change the style to be assigned to the selected CUSTOM OTS setup.

The **DELETE** LCD button deletes the selected CUSTOM OTS setup. When a CUSTOM OTS setup is deleted the original preset setup is restored.

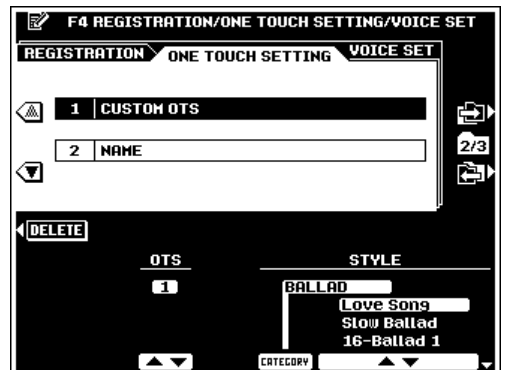
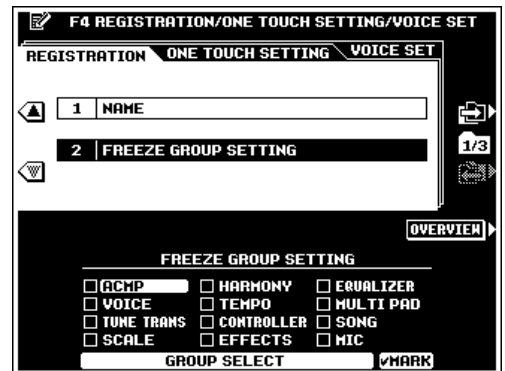
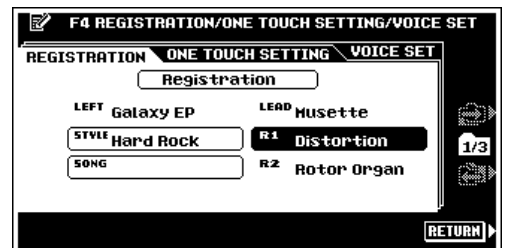
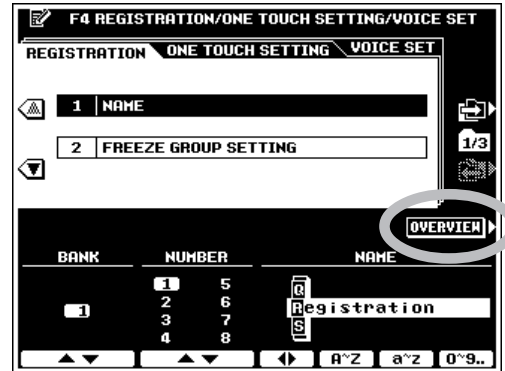

The **OVERWRITE** LCD button can be used to overwrite existing custom setup data when this display appears after the [MEMORY] button and a **ONE TOUCH SETTING** button are pressed simultaneously to create a new setup and the number of customizable setups is exceeded (page 38).

## ● NAME

You can enter descriptive names for each CUSTOM OTS setup via the NAME function. The **OTS** LCD dial selects the CUSTOM OTS setup to be named. The name can be entered as described on page 21.

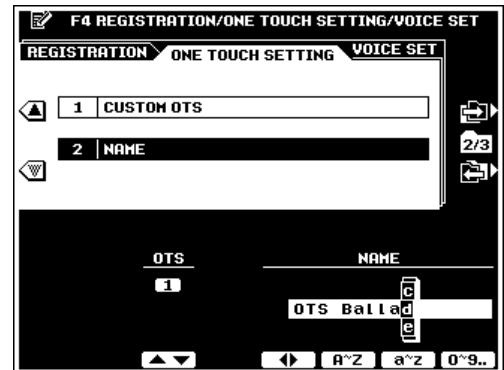

## ■ VOICE SET

This function determines whether the preset VOICE, DSP, EQ, and HRM (harmony) settings assigned to each preset voice will or will not be recalled when a new voice is selected. VOICE SET can be individually turned ON or OFF for each part. Use the ▲ and ▼ buttons to the left of the display to select a part, then use the LCD dials to turn recall of the desired settings ON or OFF for the selected part.

HRM only applies to the RIGHT 1 part. If ON, the HARMONY type preset for that voice is automatically selected when a new RIGHT 1 voice is selected.

### NOTE

- The VOICE, DSP, EQ, and HRM parameters are listed on page 171.
- There is no DSP setting for the LEFT part.





## F5: HARMONY/ECHO

This function selects the type of harmony or echo effect to be applied when the [HARMONY/ECHO] button is turned on (page 37), and the volume of the harmony sound.

Use the **TYPE** LCD dials to select the desired harmony type. Use the **VOLUME** LCD dial to set the volume of the harmony sound. The **SPEED** LCD dial becomes active when any of the echo-based effects are selected (12 through 14), and can be used to adjust the speed of the echo effect. The **ASSIGN** LCD dial is active when harmony types other than 11 are selected, and can be used to assign the harmony effect to the various parts as follows:.

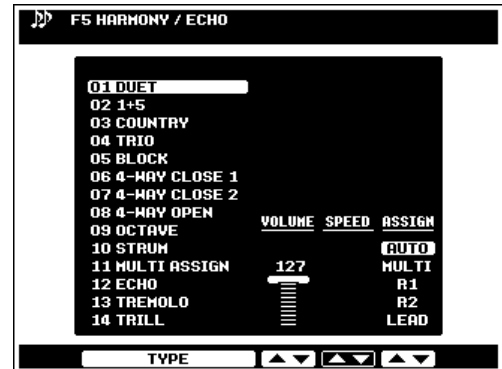

<b>AUTO</b>	Harmony notes are automatically assigned to the R1, Lead, and R2 parts, in that order or priority.
<b>MULTI</b>	MULTI ASSIGN automatically assigns the 1st, 2nd, and 3rd added harmony notes to separate parts (voices). For example, if the R1, and LEAD parts are turned on and the DUET HARMONY type is selected, then the note you play on the keyboard will be played by the R1 voice, and the added harmony note will be played by the LEAD voice.
<b>R1</b>	Harmony is only applied to the R1 part. If R1 is OFF there will be no harmony effect.
<b>R2</b>	Harmony is only applied to the R2 part. If R2 is OFF there will be no harmony effect.
<b>LEAD</b>	Harmony is only applied to the LEAD part. If LEAD is OFF there will be no harmony effect.

**NOTE**

- The **ASSIGN** setting is not available when the **MULTI ASSIGN** type (page 37) is selected.
- Changing the **VOLUME** setting may have no effect with some voices.

## F6: CUSTOMIZE LIST

This function allows you to customize the PSR-8000 **VOICE** and **STYLE** list displays within each category for convenient access to the voices and styles you use the most.

If the **RETURN** LCD button is showing, press it to return to the initial display. The initial display simply lets you select one of three **VOICE** or **STYLE** list types: **PRESET 1** (different types of voices/styles listed on a single page), **PRESET 2** (related voices/styles listed on a single page), or **USER**. The default is **PRESET 1**. Use the ▲ and ▼ buttons to the left of the display to select the **VOICE** or **STYLE** lists, then use the **TYPE** LCD dials to assign the desired list type.

The **USER** list can be customized via the **CUSTOMIZE LIST** display accessed by the **CUSTOMIZE LIST** LCD button. Use the **CATEGORY** LCD dials to select a **VOICE** or **STYLE**



list category. The **PAGE** and **USER** LCD dials specify the voice or style to be exchanged with that selected by the **PRESET2** LCD dial in the next step. The **PRESET2** LCD dials specify the voice or style to be exchanged with that specified by the **PAGE** and **USER** LCD dials. Press the **CHANGE** LCD button to actually change the list contents. The **RETURN** LCD button will return you to the initial **CUSTOMIZE LIST** display.

**NOTE**

- This function does not apply to the XG, ORGAN FLUTE, and CUSTOM VOICE categories.
- This function does not apply to the GROOVE and CUSTOM style categories.



## F7: TALK SETTING

This function page includes a number of parameters which affect the microphone sound when the [TALK] button is on.

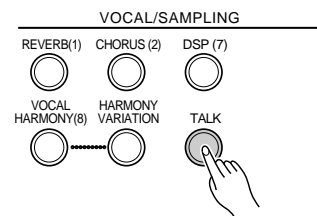

### ● VOLUME/PAN/EFFECT DEPTH

The **VOLUME** LCD dial sets the TALK volume, **PAN** sets the stereo pan position of the TALK sound, the **REVERB DEPTH** dial sets the TALK reverb depth, and the **CHORUS DEPTH** dial sets the TALK chorus depth.

### ● TOTAL VOLUME ATT.

Sets the amount of attenuation to be applied to the overall sound (but not the microphone sound) when TALK is engaged.

### ● DSP MIC

The **ON/OFF** LCD dial turns the DSP effect applied to the TALK sound ON or OFF. The **DEPTH** LCD dial sets the depth of the DSP effect applied to the TALK sound. The **TYPE** LCD dial selects the type of DSP effect to be applied to the TALK sound.

### ● VOCAL HARMONY

The **ON/OFF** dial turns VOCAL HARMONY ON or OFF, and the **TYPE** LCD dial selects the type of VOCAL HARMONY effect to be applied to the TALK sound.

**NOTE**

- The TALK settings do not affect the related MIXER parameters, and vice-versa.
- These settings are only effective when the TALK function is ON. The MIXER/panel settings take effect as soon as TALK is turned OFF.



## F8: UTILITY

The F8: UTILITY function accesses utility functions that let you turn memory backup on or off, set a number of display modes, and recall the factory preset data, etc.

### ● AUTO LOAD

Determines whether all waveform data that was in the wave RAM memory when the power was previously turned off will be automatically reloaded from disk (external floppy disk or internal hard disk) when the PSR-8000 power is turned on. Use the **AUTO LOAD** LCD dials to turn automatic waveform loading ON or OFF.

### ● MEMORY BACKUP

This function turns memory backup on or off. Use the **MEMORY BACKUP** LCD dials to turn memory backup ON or OFF.

#### NOTE

- The data backed up (retained in memory even when the power is turned off) by the PSR-8000 are listed on page 171. When memory backup is turned OFF, the initial factory settings are automatically recalled whenever the power is turned on.
- The **HELP LANGUAGE** is always backed up, regardless of the **MEMORY BACKUP** setting.
- For backup to function, the AC power must be connected or a backup battery must be installed. See page 4 for backup battery installation.

### ● DISPLAY - MIDI BANK & PC#/MESSAGE TIMEOUT

Determines whether the MIDI bank select and program change numbers for each voice will be shown along with the voice number and name on the voice list display, and how long the message displays remain on the LCD before they disappear.

### ● METRONOME VOLUME/POLY COUNTER

Use the **METRONOME VOLUME** LCD dials to set the volume of the PSR-8000 metronome sound.

The maximum number of polyphonic layers played appears next to "POLY COUNTER" on the display. This can be useful in determining whether the maximum polyphony has been exceeded in songs or custom styles. The maximum value is 64 (the PSR-8000's maximum polyphony). Press the **POLY COUNTER CLEAR** LCD button to reset the counter to "0".

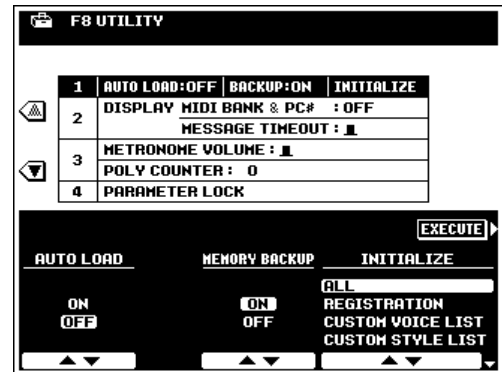

### ● INITIALIZE

Recalls the specified initial factory settings.

Use the **INITIALIZE** LCD dials to select the type of factory preset data you want to recall, then press the **EXECUTE** LCD button.

#### NOTE

- The "ALL" setting initializes all data listed in the INITIALIZE list.
- All internal data can be initialized to the original factory settings by turning the [STANDBY] switch on while holding the highest key on the keyboard (C6). This includes settings not included in the INITIALIZE list.



## ● PARAMETER LOCK

This function can be used to “lock” the specified parameters so that they can only be changed via the direct panel controls (i.e. but not via the REGISTRATION MEMORY, OTS, MIDI, sequence data, etc.). Use the **SELECT** LCD dials to select a parameter you want to lock or unlock, then use the **MARK** LCD dial to lock (check) or unlock (un-check) the selected parameter.

**NOTE**

- *MASTER EQ* refers to the MASTER EQ type (PRESET1, 2, USER1, 2).
- *MIC SETTING* refers to all MIC-related parameters in the FULL and FADER MIXING CONSOLE displays.
- See page 171 for a complete list of the parameters included in each item.

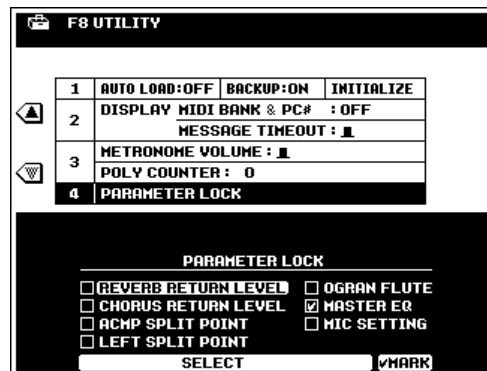

## F9: MIDI

MIDI, the Musical Instrument Digital Interface, is a world-standard communication interface that allows MIDI-compatible musical instruments and equipment to share musical information and control one another. This makes it possible to create “systems” of MIDI instruments and equipment that offer far greater versatility and control than is available with isolated instruments. The PSR-8000 offers a range of MIDI functions that allow it to be used in even sophisticated MIDI systems.

**NOTE**

- Always use a high-quality MIDI cable to connect MIDI OUT to MIDI IN terminals. Never use MIDI cables longer than about 15 meters, since cables longer than this can pick up noise which can cause data errors.
- Be sure to set the HOST SELECT switch to MIDI when using the MIDI connectors. The MIDI connectors do not function when the HOST SELECT switch is in any other position.
- No MIDI or TO HOST transmission or reception occurs in the SAMPLING mode.

## TEMPLATE

This function lets you select one of 10 preset MIDI setup templates (5 transmit and 5 receive) or select/program one of 6 USER templates (3 transmit and 3 receive). The MIDI templates includes settings from the SYSTEM, TRANSMIT, and RECEIVE function pages, described below.

### The MIDI Templates

<b>Tx Preset 1</b>	<b>Keyboard Out</b>	Transmits Voice Part and Multi Pad data.
<b>Tx Preset 2</b>	<b>ACMP Out</b>	Transmits Voice Part and Auto Accompaniment data.
<b>Tx Preset 3</b>	<b>Song Out</b>	Transmits Song playback data.
<b>Tx Preset 4</b>	<b>Master Keyboard 1</b>	The PSR-8000 functions as a master keyboard for controlling external tone generators or other devices.
<b>Tx Preset 5</b>	<b>Master Keyboard 2</b>	The PSR-8000 functions as a master keyboard which does not transmit aftertouch data.
<b>Rx Preset 1</b>	<b>XG Module</b>	The PSR-8000 functions as an XG and GM compatible 16-channel multi-timbre tone generator.
<b>Rx Preset 2</b>	<b>MIDI Accordion 1</b>	An ideal setup for use with a MIDI accordion.
<b>Rx Preset 3</b>	<b>MIDI Accordion 2</b>	For use with a MIDI accordion, allowing the player to play the bass part.
<b>Rx Preset 4</b>	<b>MIDI Pedal 1</b>	For use with a MIDI pedal system when the PSR-8000 Auto Accompaniment bass note is to be specified from the MIDI pedal.
<b>Rx Preset 5</b>	<b>MIDI Pedal 2</b>	For use with a MIDI pedal system when the bass part is to be played by the player.

● **Tx RECALL/Rx RECALL**

Use the ▲ and ▼ LCD buttons to the left of the display to select Tx RECALL if you want to recall a transmit settings template, or Rx RECALL if you want to recall a receive settings template. Then use the **SELECT** LCD dials to select the desired template. Press the **EXECUTE** LCD button and then the **OK** LCD button to actually recall the selected template. An asterisk ("\*") will appear after the current template name if any of the included MIDI settings are changed after the template is recalled.

Tx RECALL display



Rx RECALL display



● **Tx STORE/Rx STORE**

After making the appropriate settings in the SYSTEM, TRANSMIT, or RECEIVE pages, use the ▲ and ▼ LCD buttons to select Tx STORE if you want to store a new transmit settings template, or Rx STORE if you want to store a new receive settings template. Then use the **SELECT** LCD dials to select the destination user template. Enter a name for the template via the **NAME** LCD dials as described on page 21. Press the **EXECUTE** LCD button and then the **OK** LCD button to actually store the template.

Tx STORE display



Rx STORE display



## SYSTEM

### ● LOCAL CONTROL

The LOCAL CONTROL parameters determine whether or not the corresponding PSR-8000 parts/voices are controlled via the PSR-8000 keyboard, sequence data, or accompaniment playback.

When local control is on, the PSR-8000 keyboard controls its internal tone generator, allowing the internal voices to be played directly from the keyboard or internal data. Local control can be turned off, however, so that the PSR-8000 does not play the specified voices, but the appropriate MIDI information is still transmitted via the MIDI OUT connector. At the same time, the internal tone generator responds to MIDI information received via the MIDI IN connector. This means that while an external sequencer or MIDI computer, for example, plays the PSR-8000's voices, an external tone generator can be played from the PSR-8000.

Use the **SONG**, **ACMP**, **M.PAD**, **LEFT**, **R1**, **R2**, and **LEAD** LCD dials to turn local control of the corresponding items ON or OFF. A check mark appears in the appropriate LOCAL CONTROL box in the upper part of the display when local control of the corresponding part/voice is turned on.

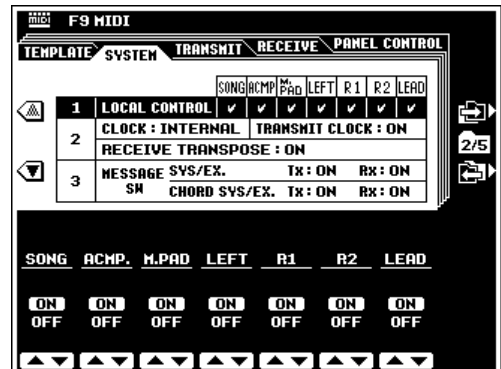

### ● CLOCK & RECEIVE TRANSPOSE

<b>CLOCK</b>	Determines whether the PSR-8000 is controlled by its own internal clock or a MIDI clock signal received from an external device. INTERNAL is the normal CLOCK setting when the PSR-8000 is being used alone. If you are using the PSR-8000 with an external sequencer, MIDI computer, or other MIDI device, and you want the PSR-8000 to be synchronized to the external device, set this function to EXTERNAL. In the latter case, the external device must be connected to the PSR-8000 MIDI IN connector, and must be transmitting an appropriate MIDI clock signal.
<b>TRANSMIT CLOCK</b>	Turns MIDI clock transmission ON or OFF. When OFF, no MIDI clock or START/STOP data is transmitted. Use the TRANSMIT CLOCK dials to turn ON or OFF as required.
<b>RECEIVE TRANSPOSE</b>	When the RECEIVE TRANSPOSE parameter is turned OFF note data received by the PSR-8000 is not transposed, and when set to ON the received note data is transposed according to the current PSR-8000 transpose setting.

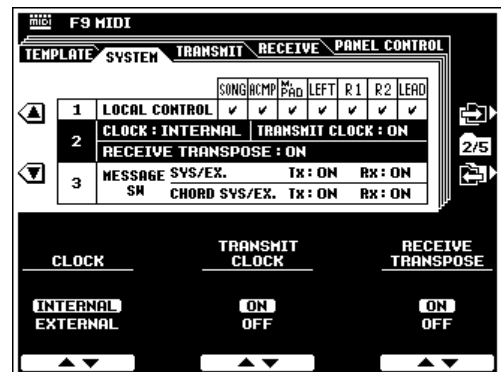

● **MESSAGE SWITCH**

The **SYS/EX. TRANSMIT** parameter turns MIDI transmission of MIDI exclusive data ON or OFF. The **SYS/EX. RECEIVE** parameter turns MIDI reception of MIDI exclusive data generated by external equipment ON or OFF.

The **CHORD SYS/EX. TRANSMIT** parameter turns MIDI transmission of MIDI chord exclusive data (chord detect — root and type) ON or OFF. The **CHORD SYS/EX. RECEIVE** parameter turns MIDI reception of MIDI chord exclusive data generated by external equipment ON or OFF.

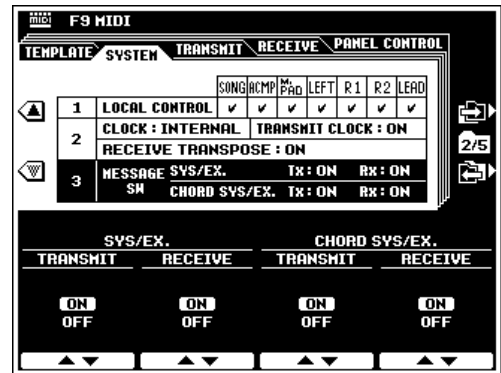

**TRANSMIT**

This display page allows you to specify which PSR-8000 voices and parts will be transmitted via which MIDI channels (there are 16 MIDI channels), and to specify which types of data will be transmitted for each channel.

● **TRANSMIT MONITOR**

The Tx MONITOR (transmit monitor) at the top of the display indicates when data is being transmitted on any of the 16 MIDI channels: The dots corresponding to each channel (1 ... 16) flash briefly whenever any data is transmitted on the channel(s).

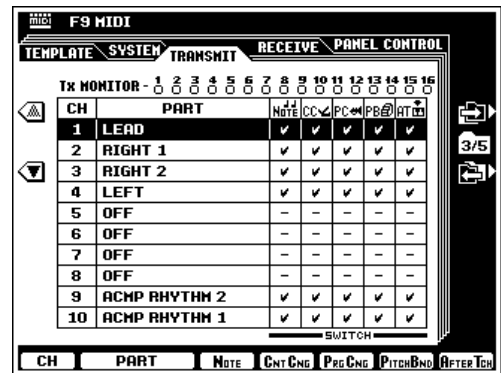

● **CHANNEL**

Use either the ▲ and ▼ LCD buttons to the left of the display, or the CH LCD dial to select the channel to which you want to assign a part or change a data switch setting. The channel numbers are shown in the leftmost column in the display.

● **PART**

The PART LCD dials select the voice or part which will be transmitted via the currently selected channel. Only one voice or part can be specified per channel. Any of the parts listed to the right can be selected. If one part is assigned to multiple channels, only the lowest-numbered channel will be used.

OFF	No data will be transmitted on the selected channel.
LEAD RIGHT 1 RIGHT 2 LEFT UPPER LOWER	Only data corresponding to the specified voice will be transmitted on the selected channel. * UPPER: above the "A" split point * LOWER: below the "A" split point
MULTI PAD 1 MULTI PAD 2 MULTI PAD 3 MULTI PAD 4	Multi pad phrases from the corresponding pad are transmitted via the selected channel.
ACMP RHYTHM 1 ACMP RHYTHM 2 ACMP BASS ACMP CHORD 1 ACMP CHORD 2 ACMP PAD ACMP PHRASE1 ACMP PHRASE2	The specified accompaniment part is transmitted via the selected channel.
SONG 1 ... SONG 16	The specified SONG track is transmitted via the selected channel.

## ● NOTE, CONTROL CHANGE, PROGRAM CHANGE, PITCH BEND, & AFTER TOUCH SWITCH

These "switches" turn transmission of the specified data type on or off. Use the **NOTE**, **CNTCNG**, **PRGCNG**, **PITCHBND**, and **AFTERTCH** LCD dials to turn transmission of the corresponding data on or off. A check mark appears in the appropriate box when the corresponding switch is turned on.

### NOTE

- "-" appears for parts for which the switches cannot be turned ON.
- The PSR-8000 **TRANPOSE** and **OCTAVE** settings do not apply to note data transmitted from the **UPPER** and **LOWER** parts.
- When **UPPER** is selected, a program change number is transmitted when the **REGISTRATION MEMORY** is switched.
- No note data will be transmitted if the panel **[LEAD]**, **[RIGHT1]**, **[RIGHT2]**, or **[LEFT] PART ON/OFF** button is turned off even if it is assigned to a channel.
- For the **LOWER** part, note data (keyboard-played note only) will be transmitted only when **AUTO ACCOMPANIMENT** is turned on.

<b>NOTE</b>	This switch turns transmission of the note data on or off. When off, no notes will be produced by an external instrument or tone generator even when the voice or part assigned to the selected channel is played. Note transmission can be turned off, for example, you only want the external device to respond to program change numbers, changing the selected voice without actually playing it.
<b>CNTCNG</b> (Control Change)	Turns transmission of control change data on or off. Control change data includes modulation wheel, foot controller, and any other controller data (except the pitch bend wheel, which has its own switch, below).
<b>PRGCNG</b> (Program Change)	Turns transmission of program change data on or off. Program change data corresponds to voice or "patch" numbers, and is used to select the corresponding voices on an external MIDI device.
<b>PITCHBND</b> (Pitch Bend)	Turns transmission of pitch bend wheel data on or off.
<b>AFTERTCH</b> (After-touch)	Turns transmission of keyboard aftertouch data on or off.

## RECEIVE

This display page allows you to specify the MIDI receive mode for each PSR-8000 MIDI channels, and to specify which types of data will be received via each channel.

### ● RECEIVE MONITOR

The Rx MONITOR at the top of the display indicates when data is being received on any of the 16 MIDI channels: The dots corresponding to each channel (1 ... 16) flash briefly whenever any data is received on the channel(s).

### ● CHANNEL

Use either the ▲ and ▼ LCD buttons to the left of the display, or the **CH** LCD dial to select the channel to which you want to assign a mode or change a data switch setting. The channel numbers are shown in the leftmost column in the display.

### ● MODE

The **MODE** LCD dials select the receive mode for the currently selected channel. Any of the following modes can be selected:

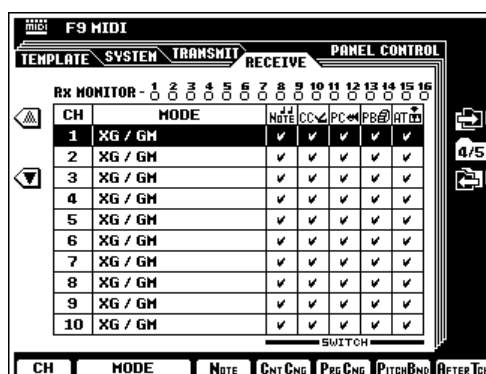

### NOTE

- Only "XG/GM" and "OFF" can be selected for channel 10.



<b>OFF</b>	No MIDI data is received.
<b>XG/GM</b>	This is the "Multi-Timbre" mode in which the corresponding channel of the internal XG/GM tone generator is directly controlled by the received MIDI data.
<b>LEAD</b>	The LEAD part is controlled by the MIDI data received on the corresponding channel.
<b>RIGHT 1</b>	The RIGHT 1 part is controlled by the MIDI data received on the corresponding channel.
<b>RIGHT 2</b>	The RIGHT 2 part is controlled by the MIDI data received on the corresponding channel.
<b>LEFT</b>	The LEFT part is controlled by the MIDI data received on the corresponding channel.
<b>KEYBOARD</b>	MIDI note data received by the PSR-8000 plays the corresponding notes in the same way as if they were played on the keyboard.
<b>CHORD</b>	The received notes are used for chord detection for all accompaniment parts other than BASS.
<b>ROOT</b>	The received note is used as the root note for the accompaniment BASS part only.
<b>ACMP RHY1~2</b>	The received notes are used as the accompaniment RHYTHM 1 and RHYTHM 2 notes.
<b>ACMP BASS</b>	The received notes are used as the accompaniment BASS notes.
<b>ACMP CHD1~2</b>	The received notes are used as the accompaniment CHORD 1 and CHORD 2 notes.
<b>ACMP PAD</b>	The received notes are used as the accompaniment PAD notes.
<b>ACMP PHR1~2</b>	The received notes are used as the accompaniment PHRASE 1 and PHRASE 2 notes.
<b>PANEL CONTROL</b>	When this mode is selected the received MIDI data controls the PSR-8000 panel operations rather than playing the internal tone generator. Which panel operations are controlled by which types of MIDI data are specified in the PANEL CONTROL display page, described below.
<b>VOCAL HARMONY</b>	Received notes are used as the added VOCAL HARMONY Vocoder type notes. The volume, pan, detune, modulation, and pitch bend of the VOCAL HARMONY notes (for any type) can be adjusted via control change or pitch bend data.

## ● NOTE, CONTROL CHANGE, PROGRAM CHANGE, PITCH BEND, & AFTER TOUCH SWITCH

These "switches" turn reception of the specified data type on or off. Use the **NOTE**, **CNTCNG**, **PRGCNG**, **PITCHBND**, and **AFTERTCH** LCD dials to turn reception of the corresponding data on or off. A check mark appears in the appropriate box when the corresponding switch is turned on.

### NOTE

- When the receive mode is set to **KEYBOARD**, received program change data switches the **REGISTRATION MEMORY** setup.
- "-" is displayed for receive modes for which the switches cannot be turned ON.

<b>NOTE</b>	This switch turns reception of the note data on or off. When off, no notes will be produced by the PSR-8000 even when note data is received on the selected channel.
<b>CNTCNG</b> (Control Change)	Turns reception of control change data on or off. Control change data includes modulation wheel, foot controller, and any other controller data (except the pitch bend wheel, which has its own switch, below).
<b>PRGCNG</b> (Program Change)	Turns reception of program change data on or off. Program change data corresponds to voice or "patch" numbers, and will select the corresponding voices on the PSR-8000 when the PRGCNG parameter is on.
<b>PITCHBND</b> (Pitch Bend)	Turns reception of pitch bend wheel data on or off.
<b>AFTERTCH</b> (After-touch)	Turns reception of keyboard aftertouch data on or off.

## PANEL CONTROL

The parameters in this display page assign specific PSR-8000 panel controls to notes. The assigned notes then control the corresponding panel control operations when received via a MIDI channel which is set to the PANEL CONTROL receive mode in the **RECEIVE** display, above.

### ● OCTAVE

Use either the ▲ and ▼ LCD buttons to the left of the display, or the **OCT** LCD dial to select the octave in which you want to assign a note. The selected octave appears between the ▲ and ▼ LCD buttons to the left of the display. The "C" note in octave "3" corresponds to C3 (middle C) on the keyboard.

### ● NOTE

Use the **NOTE** LCD dial to select the note to which you want to assign a panel control function.

### ● TYPE SELECT

Use the **TYPE SELECT** LCD dials to assign a panel control function to the selected note.

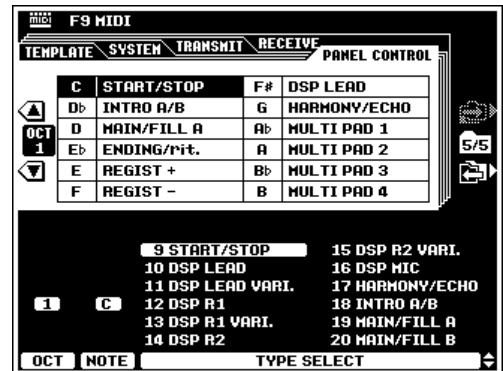

### NOTE

- All panel control functions other than those listed below function in the same way as the corresponding panel control or footswitch.
- 17. HARMONY/ECHO: HARMONY/ECHO is on only while the assigned key is held.
- 23. F.CHORD1/2: The assigned key alternately switches between the FINGERED CHORD 1 and FINGERED CHORD 2 AUTO ACCOMPANIMENT fingering modes.
- 24. BASS HOLD: BASS HOLD is on only while the assigned key is held.
- 25/26. PERCUSSION1/PERCUSSION2: The percussion instrument assigned to FOOTSWITCH 1/2 will sound when the assigned key is played.
- 27. ACMP BREAK: The AUTO ACCOMPANIMENT is halted while the assigned key is pressed.

# Disk Operations

The PSR-8000 [DISK] button accesses a range of functions that are used for storage and retrieval of floppy disk data. The PSR-8000 can also be fitted with an optional internal hard disk for massive on-line storage capacity. See page 156 for details on hard disk installation. To select a disk operation first press the [DISK] button, then press the LCD button corresponding to the operation you want to perform.

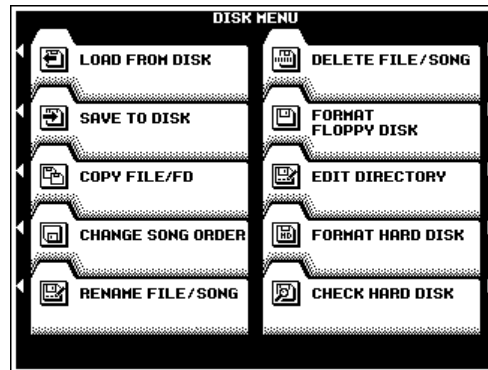
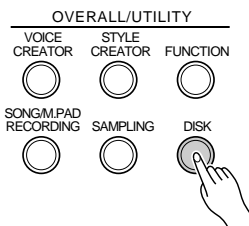

**NOTE**

- Please note that no other PSR-8000 functions will operate while a disk function is in progress.
- For any floppy disk operation an appropriate floppy disk must first be properly inserted into the PSR-8000 disk drive. The PSR-8000 uses only 3.5" 2DD and 2HD type floppy disks. Make sure the disk write protect tab is set to the "write enable" position if you intend to save any data to the disk, and insert the disk with the sliding disk cover facing the disk drive and the disk label facing upward. Before a new disk can be used to save data, it must be formatted using the "FORMAT FLOPPY DISK" function described on page 146.

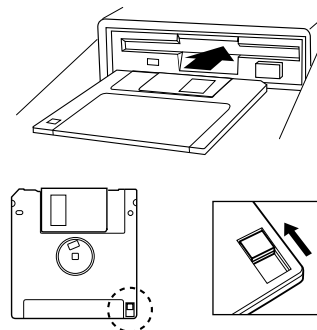

Write protect tab closed (unlocked — write enabled)

## The DISK Parameters

The **DISK** mode has the following display pages:

<b>LOAD FROM DISK</b> .....	140
<b>SAVE TO DISK</b> .....	141
<b>COPY FILE/FD</b> .....	143
<b>CHANGE SONG ORDER</b> .....	144
<b>RENAME FILE/SONG</b> .....	145
<b>DELETE FILE/SONG</b> .....	145
<b>FORMAT FLOPPY DISK</b> .....	146
<b>EDIT DIRECTORY</b> .....	146
<b>FORMAT HARD DISK</b> .....	147
<b>CHECK HARD DISK</b> .....	147

**NOTE**

- The **EDIT DIRECTORY**, **FORMAT HARD DISK**, and **CHECK HARD DISK** functions are only available when an optional hard disk unit is installed in the PSR-8000 (page 156).

## Exiting

The [EXIT] or [DISK] button can be used at any time to exit from a parameter display and return to the DISK MENU. Pressing the [EXIT] or [DISK] button while the DISK MENU is showing will return you to the normal play mode.

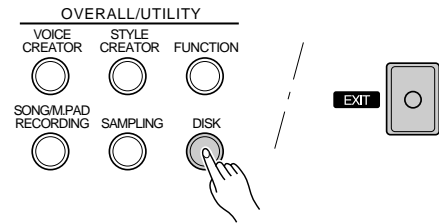

## LOAD FROM DISK

Loads the specified file from a floppy disk inserted into the PSR-8000 disk drive, or the optional hard disk.

Use the **FILE LIST** LCD dials to select the file to load. The size of the file appears to the right of the file name in kilobytes (approximate). Also, the types of data included in the selected file are indicated by checkmarks in the corresponding boxes in the upper section of the display (see chart below).

If a hard disk is present the **DIRECTORY** dials can be used to select the internal hard disk directories or the floppy disk drive.

If you want to select a specific type of data to load, press the **PROGRAM** LCD button. The LCD dials can now be used to select the type(s) of data to be loaded from the selected file. Data types which are turned ON are loaded.

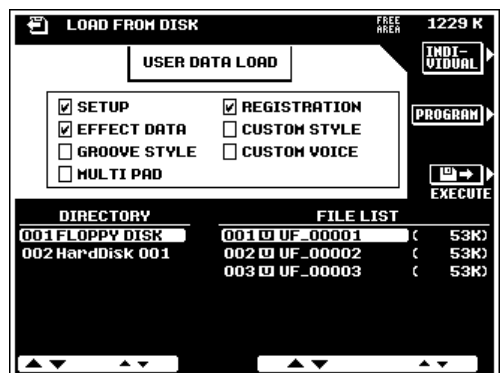

<b>SETUP</b>	All setup data — see list on page 171.
<b>EFFECT DATA</b>	All “User Set” effect data — page 43.
<b>GROOVE STYLE</b>	All GROOVE STYLE settings — page 81.
<b>MULTI PAD</b>	All MULTI PAD user data (banks 51 ... 60) — page 51.
<b>REGISTRATION</b>	All REGISTRATION memory data — page 46.
<b>CUSTOM STYLE</b>	All CUSTOM STYLE data — page 62.
<b>CUSTOM VOICE</b>	All CUSTOM VOICE data including wave data saved using the WAVE save option — page 51.

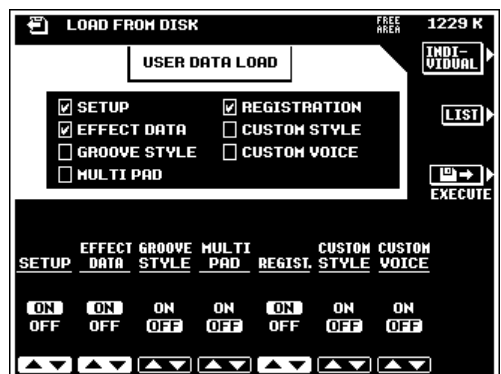

Press the **LIST** LCD button when you want to go back to the **FILE LIST** display.

If you want to load an individual registration, style, or voice, press the **INDIVIDUAL** LCD button.

In the **INDIVIDUAL LOAD** display use the **DATA** LCD dial to select **REGIST**, **M.PAD**, **STYLE**, **GROOVE** or **VOICE**, the **CONTENT** LCD dials to select the individual file to be loaded,



and the **DEST. REGIST.**, **DEST. MULTI PAD**, **CUSTOM STYLE**, **GROOVE STYLE**, or **CUSTOM VOICE** LCD dials to select the destination for the selected individual file.

When the **INDIVIDUAL** mode is selected and **STYLE** is selected for loading, a **PRE-LOAD LISTEN** LCD button appears which lets you listen to the style before actually loading it (press the **PRE-LOAD LISTEN** button a second time to stop playback). The **PRE-LOAD LISTEN** function will not work if there is too much style data, however.

When the file and data types have been specified, press the **EXECUTE** LCD button to actually begin the load operation. When performing an **INDIVIDUAL** load, be sure to press the **EXECUTE** LCD button in the **INDIVIDUAL** display (i.e. do not return to the **LIST** display before executing).

**NOTE**

- Data spanning two or more disks (i.e. "split" data) cannot be loaded using the **INDIVIDUAL LOAD** function.
- When loading **CUSTOM STYLE**, **GROOVE STYLE**, **CUSTOM VOICE**, or **MULTI PAD** data — not in the **INDIVIDUAL** mode — all data will be loaded even if the loaded file contains empty data (i.e. any previous data will be erased). Empty **REGISTRATION MEMORY** data, however, will not be loaded.
- **SFF** (optional style file format) disks can also be loaded when using the custom style load function.

## SAVE TO DISK

Saves the data listed below to a floppy disk inserted into the PSR-8000 disk drive, or to the optional hard disk.

To overwrite the data in an existing file, use **FILE LIST** LCD dials to select the file to which you want to save the data.

If a hard disk is present the **DIRECTORY** dials can be used to select the hard disk directory to which the file is to be saved.

The file list at the bottom of the display includes all files which currently exist on the disk. The size of each file will appear to the right of the file name in kilobytes (approximate). Also, the **FREE AREA** value in the upper right corner of the display shows the amount of free space remaining on the selected floppy disk or hard disk.

To specify the type(s) of data to be saved, press the **PROGRAM** LCD button. The **▲** and **▼** LCD buttons to the left of the display can now be used to select various groups of data, and the LCD dials can be used to select the individual item(s) to be saved. Items which are turned ON are saved. The **ALL ON** and **ALL OFF** LCD buttons can be used to turn all items in the currently selected group ON or OFF at once. The **USER DATA SAVE** value at the top of the upper section of the display indicates the amount of data to be saved according to the selected items.

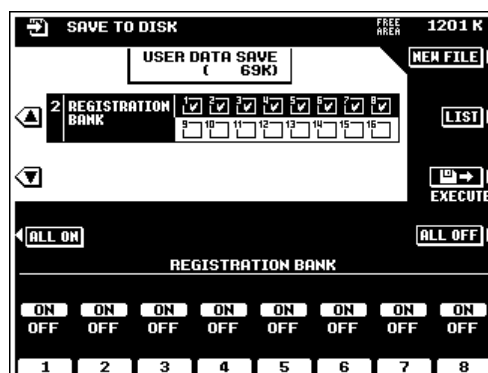
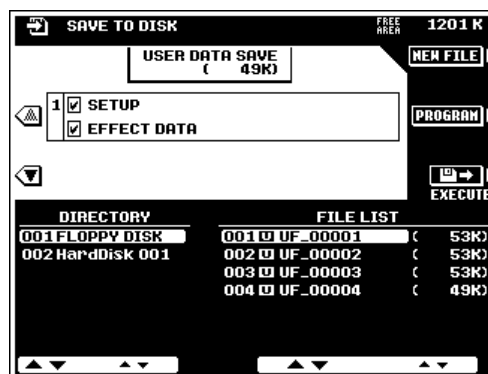

<b>SETUP</b>	All setup data — see list on page 171.
<b>EFFECT DATA</b>	All “User Set” effect data — page 43.
<b>REGISTRATION BANK</b>	The ▲ and ▼ LCD buttons select REGISTRATION memory bank groups 1... 8 and 9 ... 16. The LCD dials turn the individual banks within the selected group ON or OFF.
<b>GROOVE STYLE</b>	The ▲ and ▼ LCD buttons select GROOVE STYLE memory groups 1... 8, 9...16 and 17 ... 20. The LCD dials turn the individual groove style within the selected group ON or OFF.
<b>MULTI PAD</b>	The ▲ and ▼ LCD buttons select MULTI PAD memory bank groups 1... 8 and 9 ... 10. The LCD dials turn the individual banks within the selected group ON or OFF.
<b>CUSTOM STYLE</b>	The ▲ and ▼ LCD buttons select CUSTOM STYLE memory groups 1... 8 and 9...16. The LCD dials turn the individual custom style within the selected group ON or OFF.
<b>CUSTOM VOICE</b>	The ▲ and ▼ LCD buttons select CUSTOM VOICE memory groups 1... 8, 9 ... 16, 17 ... 24, or 25 ... 32. The LCD dials turn the individual custom voice within the selected group ON or OFF. The WAVE option becomes available when a custom voice uses a sampled wave, causing the wave to be saved with the voice.
<b>LINK TO SONG</b>	This option “links” all data saved in the file to a specified song. The file will be loaded automatically when the song to which it is linked is played (a confirmation display allows you to choose whether or not to load the data). After turning the LINK TO SONG option ON, use the SONG LIST LCD dials to select the song to which the file is to be linked. Only one file can be linked to each song (the last-linked file takes priority), and files can only be linked to songs in the same directory or floppy disk.

Press the **LIST** LCD button when you want to go back to the **FILE LIST** display.

When the file and data types have been specified, press the **EXECUTE** LCD button to actually begin overwriting the specified file, or press the **NEW FILE** LCD button if you want to save the data to a new file.

If you choose to save the data to a new file and want to give the file to be saved an original file name, be sure to do so before pressing the **YES** LCD button. File names can be entered as described on page 21.

**NOTE**

- All checked data types — not only those in the group showing in the program or list display — will be saved.
- Items containing no data cannot be turned on.
- When overwriting an existing file, all data is saved. This means that previous data corresponding to unchecked (OFF) items will be overwritten with “empty” data.
- “AUTO LXXX” (X=any character) or a name consisting of all spaces are not permitted as a file names. If spaces are used as a file name they will automatically be changed to the underline character “\_”.
- If a hard disk is present, data load and save operations can be speeded up by organizing your data in separate directories.



## COPY FILE/FD

This function can be used to copy songs, commercially available style files, or wave files (WAV or AIFF format) to a different number/name on the same floppy disk, or from one floppy disk to another. If the optional hard disk is present files can be copied to a different hard disk directory. It is also possible to make complete copies of floppy disks. A perfect way to make backup copies of important files and disks.

### NOTE

- Custom style files created on the PSR-8000 cannot be copied using the style file copy function.

## Copying Files

Use the **COPY** LCD button to select the type of file to be copied. Song, style, wave, and disk copy are selected in sequence each time the **COPY** LCD button is pressed (disk copy is described “Copying Floppy Disks”, below).

If a hard disk is present the **DIRECTORY** dials can be used to select the directory containing the file to be copied. Use the **SONG LIST**, **STYLE LIST**, or **WAVE LIST** LCD dials to select the source file.

The size of the file appears to the right of the file name in kilobytes (approximate). If a song file is selected the **LISTEN** LCD button can be used to listen to the currently selected source song file — press **LISTEN** again to stop playback when done.

When the source file has been selected press the **DESTINATION** LCD button and use the **DESTINATION** LCD dials to select the destination disk. Select “another FD” to copy to a different floppy disk, or “FLOPPY DISK” to copy to the same floppy disk, or “HardDisk” to copy to the internal hard disk, if installed. The **FREE AREA** value in the upper right corner of the display shows the amount of free space remaining on the selected floppy disk or hard disk.

Press the **EXECUTE** LCD button to begin the copy operation. At this point you will have a chance to change the file name before it is copied. File names can be entered as described on page 21.

If you’re copying to a different floppy disk the PSR-8000 will prompt you to insert the copy destination disk. Follow the on-screen directions. You can return to the source selection display at any time by pressing the **SOURCE** LCD button.

### NOTE

- When the “HardDisk” is selected as the source disk, the “another FD” destination option will not appear on the display.
- Some types of pre-recorded music software disks are copy protected. In such a case the “another FD” and “FLOPPY DISK” destination options will not be available.

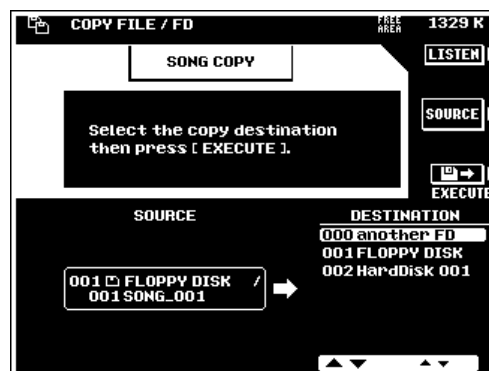
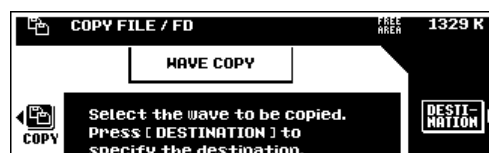
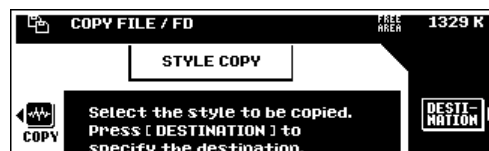

## Copying Floppy Disks

To make a complete backup copy of a floppy disk, use the **COPY** LCD button to select disk copy, insert the disk to be copied, and press the **EXECUTE** LCD button. After responding “**YES**” to the confirmation display, the number of disk exchanges needed will appear on the display. Press the **YES** LCD button to continue, and follow the on-screen instructions, exchanging the source and destination disks as necessary until the copy is complete.

**NOTE**

- The **COPY FD** function cannot be used to copy hard disk data.
- Copies can only be made to the same type of floppy disk as the source disk (i.e. 2HD to 2HD or 2DD to 2DD).
- Some types of pre-recorded music software disks are copy protected.



## CHANGE SONG ORDER

This function allows the order of song files in a hard-disk directory or floppy disk to be changed as required.

If a hard disk is present, use the **DIRECTORY** LCD dials to select the hard-disk directory or floppy disk containing the files to be re-ordered.

Use the **ORDER LIST** dials to select a file to be re-positioned within the list (the **LISTEN** LCD button can be used to listen to the selected song — press **LISTEN** again to stop playback when done), then press the **SELECT** LCD button. When this is done the **SELECT** button will change to a **CANCEL** button which can be pressed to de-select the file and make another choice.

Use the **ORDER LIST** dials to select the file which is currently at the location where you want to insert the previously selected file (use **LISTEN**, as necessary), then press the **INS.** LCD button. The file will be inserted immediately before the selected destination file.

When all the song files have been re-ordered as required, press the **SAVE LIST** LCD button to save the re-ordered file list.

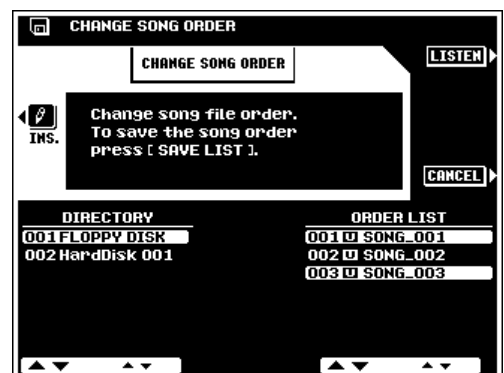
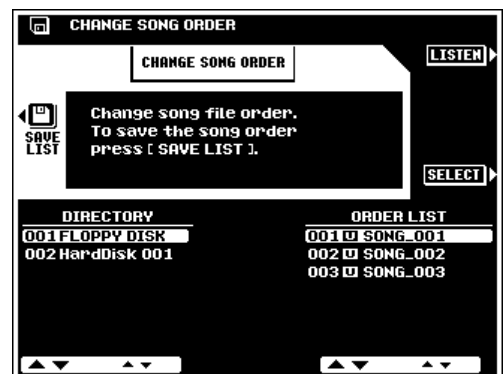



## RENAME FILE/SONG

Allows the name of the specified user-recorded song or user file to be changed as required.

Press the **SONG** LCD button if the **SONG LIST** is not showing in order to rename a song file, or the **USER FILE** LCD button if the **USER FILE LIST** is not showing in order to rename a user file. Use the **USER FILE LIST** or **SONG LIST** LCD dials to select the file you want to rename.

If a hard disk is present the **DIRECTORY** dials can be used to select the directory containing the file to be renamed.

The size of the file appears to the right of the file name in kilobytes (approximate).

The **LISTEN** LCD button which appears when the **SONG LIST** is selected can be used to listen to the currently selected song — press **LISTEN** again to stop playback when done.

When the user or song file to be renamed has been selected, press the **EXECUTE** LCD button. The name entry display will appear. File names can be entered as described on page 21.

### NOTE

- User file names which already exist cannot be entered.

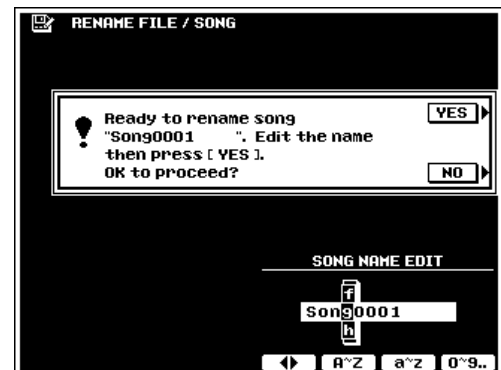

## DELETE FILE/SONG

Deletes the specified song or user file from the disk.

Press the **SONG** LCD button if the **SONG LIST** is not showing in order to delete a song file, or the **FILE** LCD button if the **FILE LIST** is not showing in order to delete a user file. Use the **FILE LIST** or **SONG LIST** LCD dials to select the file you want to delete.

If a hard disk is present the **DIRECTORY** dials can be used to select the directory containing the file to be deleted.

The size of the file appears to the right of the file name in kilobytes (approximate). The **FREE AREA** value in the upper right corner of the display shows the amount of free space remaining on the selected floppy disk or hard disk.

The **LISTEN** LCD button which appears when the **SONG LIST** is selected can be used to listen to the currently selected song — press **LISTEN** again to stop playback when done.

When the file to be deleted has been selected, press the **EXECUTE** LCD button.



### NOTE

- Files deleted from disk can not be restored (there is no "Undo" function), so be sure you've selected the right file before actually executing the delete operation.
- Commercially available style files can also be deleted via the **FILE LIST** display.

## FORMAT FD

Formats a floppy disk for use with the PSR-8000.

After inserting a new floppy disk into the disk drive, press the **EXECUTE** LCD button to actually begin the format operation.

**NOTE**

- The PSR-8000 uses only 3.5" 2DD or 2HD type floppy disks.
- Formatting a disk completely erases all data on the disk, so be sure that the disk you're formatting does not contain important data!



## EDIT DIRECTORY

Allows hard disk directories to be renamed, created, and deleted.

### NEW DIR .....

Organizing your data in separate directories can generally speed up the data load and save operations. To make a new directory, press the **NEW DIR** LCD button, create a name for the directory as described on page 21.

### RENAME .....

To change a directory name use the **DIRECTORY** dials to select the directory, press the **RENAME** LCD button, enter a new name as described on page 21.

### DELETE .....

To delete a directory use the **DIRECTORY** dials to select the directory to be deleted. Press the **DELETE** button.

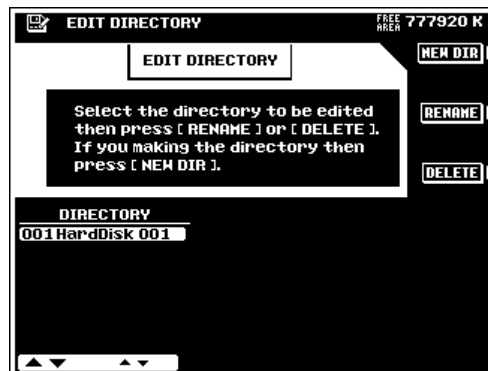

**NOTE**

- The last remaining hard disk directory cannot be deleted.
- The **DELETE** function deletes the selected directory and all files it contains — use with caution!
- Make regular backup copies of important data on floppy disks, and store the backup disks in a safe location. Use the **SONG COPY** function to copy song data from the optional internal hard disk to floppy disk. Other data must first be loaded from the hard disk and then saved to floppy disk.
- YAMAHA provides no guarantee against disk damage.

## FORMAT HARD DISK

---

To format the hard disk press the **EXECUTE** button.



- *Formats an internal hard disk for use with the PSR-8000. Any previous data on the disk will be completely erased by the format operation.*



## CHECK HARD DISK

---

Performs a check on the internal hard disk. Be sure to save all important data to floppy disk before executing the CHECK operation.

To check the disk press the **EXECUTE** button. If any errors are detected appropriate messages will be shown on the display.



# Troubleshooting

Symptom	Possible Cause/Solution
Noise is heard when the power is turned on or off.	This is a normal result of the power surge that occurs when the unit is turned on or off, and is not a problem.
No sound.	The volume controls or foot volume are turned all the way down. Set the volume controls (both the master volume control and the mixing console part volume controls) and foot volume to a reasonable listening level.
	Are the desired parts turned on?
	A pair of headphones is plugged into the PHONES jack. Unplug the headphones.
	A plug is inserted in the LOOP SEND jacks. Unplug the LOOP SEND jacks.
	Is the FOOT SWITCH connected to the FOOT VOLUME connector?
	The FADE OUT switch is on and has reached the end of its duration, muting the sound. Press the FADE IN/OUT switch so that its indicator goes out.
	MIDI local control is turned OFF. Turn MIDI local control ON using the appropriate F9 MIDI function.
The sound can't be adjusted by some mixing console controls.	Make sure that the [TALK] button is not engaged. The TALK settings take precedence when TALK is engaged. See page 130.
The accompaniment does not start.	The MIDI CLOCK setting is set to EXTERNAL. Reset the MIDI CLOCK to INTERNAL using the appropriate F9 MIDI function.
Some notes do not sound or are prematurely cut off.	The maximum polyphony has been exceeded. You can play up to 64 notes at the same time—including auto-accompaniment, song playback, multi pad notes etc.. Notes exceeding this limit will not sound. When using AUTO ACCOMPANIMENT or HARMONY/ECHO, be careful not to exceed the limit.
When a voice is changed, the previously selected effect is changed.	This is normal, each voice has its own suitable preset values which are automatically recalled when the corresponding F4 VOICE SET parameters are turned on (page 128).
There is a slight difference in sound quality between notes played on the keyboard.	This is normal and is a result of the PSR-8000's sampling system.
Some voices have a looping sound.	
Some noise or vibrato is noticeable at higher pitches, depending upon the voice.	
Some voices will jump an octave in pitch when played in the upper or lower registers.	Some voices have a pitch limit which, when reached, causes this type of pitch shift. This is normal.
The auto-accompaniment chord does not change even when a different chord is played or the chord is not recognized.	Are you sure you're playing on the left-hand section of the keyboard?
	You may be using single-finger type fingering in the fingered mode, or vice-versa. Use the correct type of chord fingering for the selected auto-accompaniment fingering mode.
	Is the auto-accompaniment fingering mode set to MANUAL BASS?

Symptom	Possible Cause/Solution
The displayed disk free area value does not coincide with the actual value.	The value is an approximate value.
Disk save operations — particularly when saving wave/waveform data to floppy disk — take a long time.	This is normal. It takes approximately 8 minutes to save 1 megabyte of data to a floppy disk.
In the SAMPLING WAVEFORM EDIT mode, added waves don't sound.	Have you set an appropriate START NOTE prior to adding the wave? See page 98.
Appropriate harmony notes are not produced by the VOCAL HARMONY feature.	Make sure you are using the appropriate method to specify the harmony notes for the current VOCAL HARMONY mode. See page 84.
The MIDI connectors don't seem to be functioning properly.	The MIDI connectors will only work when the HOST SELECT switch is set to MIDI.

- A**
- Accompaniment volume ..... 36
  - Accompaniment, starting ..... 33
  - Add wave, Sampling ..... 97
  - After touch ..... 126
    - Custom voice ..... 55
  - Audio sampling library contents ... 200
  - Auto accompaniment ..... 28
  - Auto load ..... 131
  - Auto trigger level, Sampling ..... 91
  - Aux in jacks ..... 13
  - Aux out jacks ..... 12
- B**
- Backup battery ..... 4
  - Basic parameters, Custom style .... 66
  - Brightness control ..... 41
- C**
- Change song order, Disk ..... 144
  - Check hard disk ..... 147
  - Chord detect parameter, Song ..... 102
  - Chord match mode, Multi pad ..... 121
  - Chord step data save ..... 110
  - Chord step recording ..... 109
  - Chordal, Vocal harmony ..... 86
  - Chords, recognized ..... 31
  - Chorus controls ..... 41
  - Chromatic, Vocal harmony ..... 87
  - Clear,
    - Custom style ..... 70
    - Custom voice ..... 54, 61
    - Groove style ..... 81
    - Multi pad ..... 121
    - Sampling ..... 92, 96, 98
  - Clock & receive transpose, MIDI .. 134
  - Computer connections ..... 15
  - Copy file/FD, Disk ..... 143
  - Custom style chord list ..... 65
  - Custom style creator parameters ... 66
  - Custom style editing ..... 68
  - Custom style recording ..... 62
  - Custom style recording via external sequencer ..... 73
  - Custom voice creator ..... 51
  - Customize list ..... 129
- D**
- DSP3 controls ..... 42
  - DSP4-7 controls ..... 42
  - Defragmenting memory, Sampling. 92
  - Delete file/song, Disk ..... 145
  - Delete, Sampling ..... 96, 98
  - Demonstration playback ..... 17
  - Detune, Vocal harmony ..... 87
  - Direct access button ..... 20
  - Direct access chart ..... 170
  - Disk operations ..... 139
  - Display & display-based controls ... 19
  - Display messages ..... 21
  - Display timeout ..... 131
  - Drum exchange, Groove style ..... 82
  - Dynamics, Groove style ..... 80
- E**
- EG parameters, Custom voice ..... 57
  - EG, Custom voice ..... 52
  - EQ controls ..... 40
  - Easy edit parameters, Custom voice ..... 52
  - Edit directory, Disk ..... 146
  - Effect block & type ..... 42
  - Effect depth controls ..... 41
  - Effect signal flow ..... 176
  - Effect type list ..... 42
  - Effect type parameters ..... 42
  - Element selection, Custom voice ... 54
  - Enter next song ..... 101
  - Event delete, Chord step record .. 110
  - Exit button ..... 20
  - Export as WAV, Sampling ..... 96
- F**
- Fade-ins and fade-outs ..... 35
  - Fast forward & reverse, Song ..... 102
  - Fill-ins ..... 34
  - Filter controls ..... 41
  - Filter parameters, Custom voice ... 59
  - Filter, Custom voice ..... 52
  - Fingered 1 mode ..... 31
  - Fingered 2 mode ..... 32
  - Fingering modes ..... 30, 28, 124
  - Floppy Disk ..... 5
  - Foot controller ..... 124
  - Foot pedal switch jacks ..... 14
  - Foot pedal volume jack ..... 14
  - Foot switch ..... 124
  - Format FD, Disk ..... 146
  - Format hard disk ..... 147
  - Freeze function ..... 47, 127
  - Full edit parameters, Custom voice ..... 54
  - Full keyboard mode ..... 32
  - Functions ..... 122
- G**
- Groove parameter, Groove style .... 79
  - Groove style creator ..... 76
  - Groove style parameters ..... 77
- H**
- Hard disk installation ..... 156
  - Harmonic content control ..... 41
  - Harmony/echo ..... 37, 129
  - Help function ..... 20
  - High key, Custom style ..... 72
  - High-pass filters ..... 40
  - Host select switch ..... 15
- I**
- Initial touch ..... 126
  - Initial touch curve, Custom voice ... 55
- K**
- Key on delay, Custom voice ..... 56
  - Keyboard drum assignments ..... 166
  - Keyboard percussion ..... 24
- L**
- LCD contrast control ..... 20
  - LFO parameters, Custom voice .... 59
  - Left hold ..... 27
  - Load from disk ..... 140
  - Local control, MIDI ..... 134
  - Loop point, Sampling ..... 94
  - Loop return jack ..... 13
  - Loop send jacks ..... 13
- M**
- MIDI Implementation chart ..... 196
  - MIDI connectors ..... 14
  - MIDI data format ..... 177
  - MIDI templates ..... 132
  - Main A and B sections ..... 34
  - Main features ..... 7
  - Manual bass mode ..... 32
  - Master EQ ..... 45
  - Master tune ..... 123
  - Master volume, Custom voice ..... 55
  - Measure clear, Custom style ..... 69
  - Measure copy, Custom style ..... 69
  - Measure insert & delete, Chord step record ..... 110
  - Measure set, Song record ..... 115
  - Memory backup ..... 131
  - Message switch, MIDI ..... 135
  - Metronome volume ..... 131
  - Metronome, Song record ..... 107
  - Mic/line jack ..... 12
  - Microphone level adjustment ... 83, 89
  - Mixing console ..... 39
  - Mixing console buttons ..... 19
  - Mixing console during song playback ..... 103
  - Modulation wheel ..... 27, 126
  - Modulation, Custom voice ..... 55
  - Monitor selection, Sampling ..... 92
  - Multi pad playback & recording .... 119
  - Multi-finger mode ..... 30

- Multi track record mode editing,  
Song ..... 116
- Multi track record, Song ..... 111
- Music stand ..... 16
- ## N
- NTR & NTT ..... 71
- Name entry ..... 21
- Normalize, Sampling ..... 95
- Note limit
- Custom style ..... 72
  - Custom voice ..... 56
- Note shift, Song record ..... 117
- ## O
- Octave ..... 44
- Octave change ..... 27
- One touch setting ..... 38, 127
- Options
- handling ..... 5
  - installing ..... 152
- Organ flute voice ..... 23
- Organ flute voice editing ..... 48
- ## P
- Packing list ..... 6
- Pan, Custom voice ..... 56
- Panel Controls ..... 10
- Panel control, MIDI ..... 138
- Panel logos ..... 6
- Panpot ..... 40
- Parameter chart ..... 171
- Parameter edit, Custom style ..... 71
- Parameter lock ..... 132
- Part copy, Custom style ..... 67
- Part selection ..... 24
- Part switching, accompaniment ..... 36
- Parts ..... 22
- Pause, song ..... 102
- Phones jack ..... 12
- Pitch bend range ..... 44
- Pitch bend wheel ..... 27
- Play modes, Song ..... 101
- Playback, Song record ..... 108, 114
- Poly counter ..... 131
- Poly/mono part modes ..... 22
- Portamento time ..... 44
- Pre effect, Sampling ..... 91
- Precautions ..... 4
- Punch-in recording, Song ..... 114
- ## Q
- Quantize
- Custom style ..... 68
  - Song record ..... 116
- Quick record, Song ..... 106
- ## R
- RTR, Custom style ..... 72
- Receive parameters, MIDI ..... 136
- Registration memory ..... 46, 127
- Remove control event, Custom  
style ..... 69
- Remove duplicate notes, Custom  
style ..... 70
- Rename file/song, Disk ..... 145
- Rename song
- Multi track record ..... 116
  - Quick record ..... 111
- Repeat mode, Multi pad ..... 121
- Replace recording, Song ..... 114
- Resampling, Sampling ..... 93
- Reverb controls ..... 41
- ## S
- SIMM installation ..... 152
- SIMM removal ..... 155
- Sampling ..... 88
- Sampling new material ..... 90
- Save to disk ..... 141
- Save waveform, Sampling ..... 98
- Scale ..... 123
- Scale curve, Custom voice ..... 55
- Setup copy, Custom style ..... 68
- Setup parameters
- Custom style ..... 67
  - Groove style ..... 78
  - Song record ..... 118
- Single finger mode ..... 30
- Song delete
- Multi track record ..... 117
  - Quick record ..... 111
- Song playback ..... 100
- Song playback order ..... 103
- Song recording ..... 105
- Song selection ..... 100
- Song type symbols ..... 100
- Source root & chord, Custom  
style ..... 71
- Special effects ..... 24
- Specifications ..... 203
- Split point ..... 123
- Start measure, Song record ..... 107
- Store as custom style, Groove  
style ..... 81
- Store as custom voice, Sampling ... 99
- Store
- Custom style ..... 70
  - Custom voice ..... 53, 61
  - Groove style ..... 81
- Style list ..... 168
- Style selection ..... 28
- Synchronized start ..... 33
- Synchronized stop ..... 35
- ## T
- Talk settings ..... 130
- Tempo control ..... 35
- Tempo-delay effects ..... 43
- To host connector ..... 15
- Track delete, Song record ... 108, 114
- Track indicators, Song  
record ..... 108, 113
- Track mix, Song record ..... 117
- Track modes, Song record ... 106, 111
- Track parts, Song record ..... 112
- Transmit parameters, MIDI ..... 135
- Transpose ..... 44
- Transpose, master ..... 26
- Troubleshooting ..... 148
- Tuning by tempo, Sampling ..... 95
- Tuning controls ..... 44
- Tuning, Custom voice ..... 56
- ## V
- Velocity change, Custom style ..... 69
- Velocity limit, Custom voice ..... 56
- Vibrato, Custom voice ..... 53
- Virtual arranger ..... 36
- Vocal harm. parameter, Song ..... 102
- Vocal harmony ..... 83
- Vocal harmony MIDI  
specifications ..... 199
- Vocal harmony editing ..... 84
- Vocal harmony modes ..... 85
- Vocal harmony parameters ..... 84
- Vocal harmony track ..... 84
- Vocal harmony type selection ..... 84
- Vocal/sampling buttons ..... 83
- Vocoder, Vocal harmony ..... 86
- Voice assignment ..... 24
- Voice effects ..... 26
- Voice list ..... 159
- Voice set ..... 128
- Custom voice ..... 60
- Voice, Song record ..... 118
- Voices ..... 22
- Volume controls ..... 40
- Volume, Custom voice ..... 53
- ## W
- Wave edit, Sampling ..... 93
- Waveform edit, Sampling ..... 97
- Waveform, Custom voice ..... 56
- Waves & waveforms ..... 88
- Waves, importing from disk ..... 91
- ## X
- XG voices ..... 23

The SIMMs used must meet the following minimum specifications, but this does not guarantee that they will work properly with the PSR-8000. Consult with your nearest Yamaha representative or an authorized distributor listed at the end of this manual before purchasing SIMMs for the PSR-8000.

- 16-bit bus compatibility or compliance with JEDEC standards (SIMMs which are only compatible with 32-bit buses can not be used)
- 70 nanoseconds or faster access time (note: 60 nanosecond SIMMs are "faster" than 70 nanosecond SIMMs).
- No more than 18 memory chips on each SIMM module.
- SIMM modules must be no more than 40 mm in height and the thickness of the SIMM should not exceed 8mm on either side when measured from the center of the SIMM. See below.
- SIMMs with parity and EDO DRAM modules can also be used.
- Use only 4, 8, or 16 megabyte memory modules in pairs of the same type and memory capacity from the same manufacturer: e.g. 4, 8, or 16 megabytes x 2.
- Install SIMM memory at your own risk. Yamaha will not be held responsible for any damage or injury resulting from improper installation.

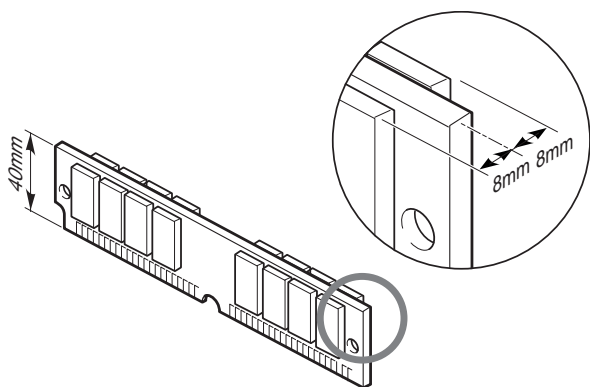

1

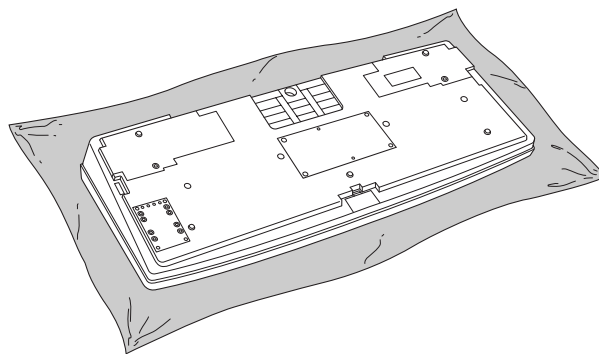

## Optional SIMM Installation

- 1 Before installing the SIMMs be sure to save any important data to disk by using the SAVE TO DISK function described on page 141. Also remove the backup batteries. Turn the PSR-8000 power OFF and unplug the power cord from both the AC wall socket and the instrument's rear panel. Turn the instrument upside down and rest it on a blanket or other soft surface.



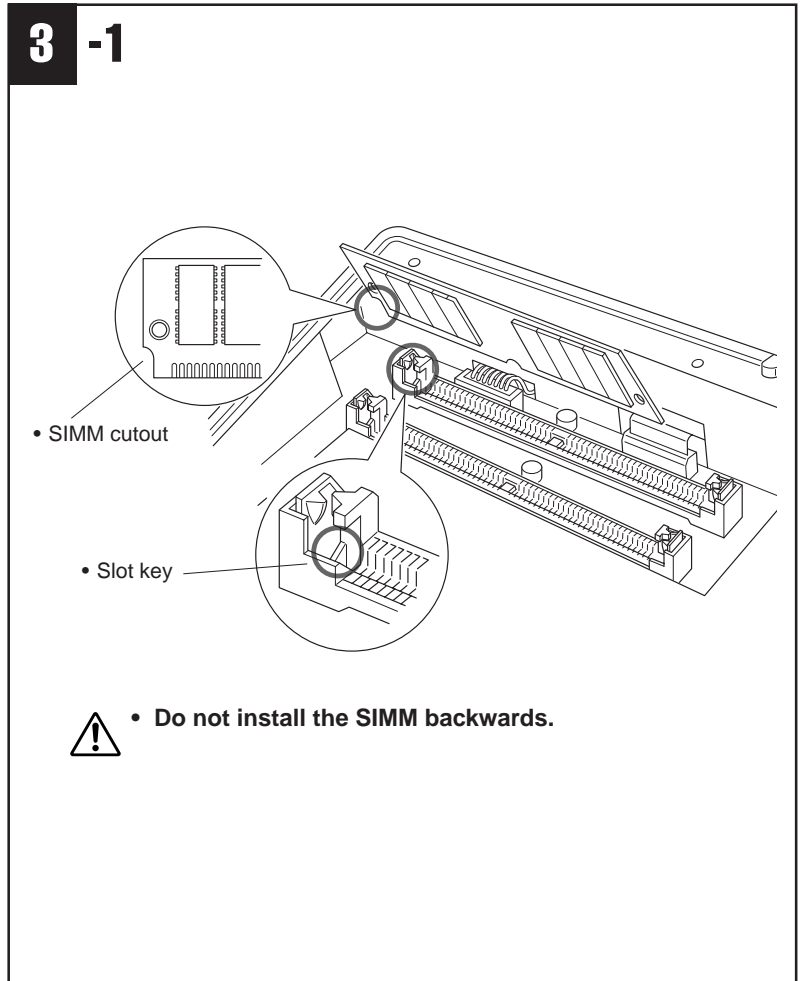
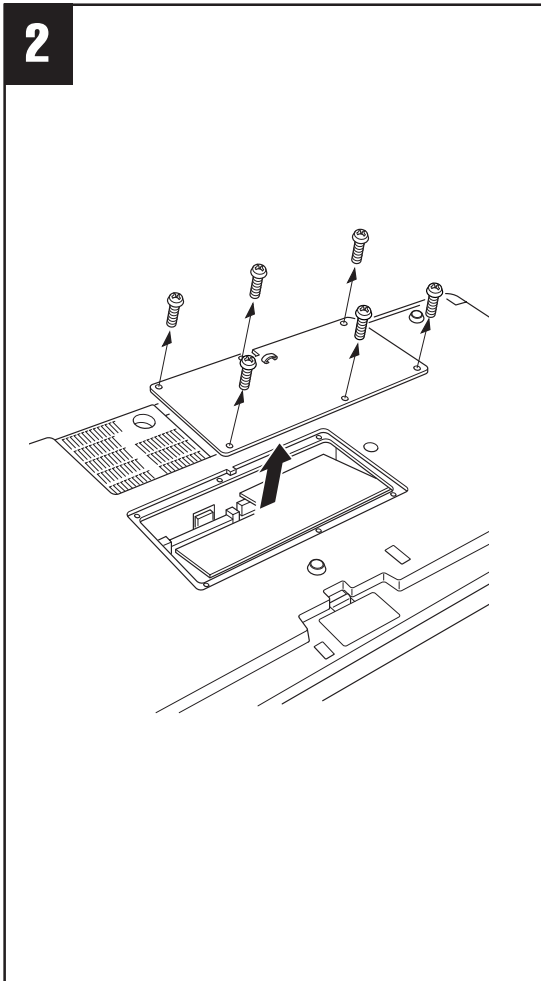

**2** Remove the six screws from the SIMM cover in the center of the instrument's bottom panel, and remove the cover.

Do not remove the circuit board in front of the SIMM slot (the system memory is on this board).

**3** Insert the SIMMs in the SIMM slots as described below.

**WARNING**  
Install the SIMM modules carefully as per the procedure outlined below (steps 3-1 through 3-3). Improper installation can cause shorts which may result in irreparable damage and pose a fire hazard.

**Carefully remove dust and dirt.**  
Make sure that there is no dust or dirt on or around the SIMM edge terminals or the connector slots before installation.

### First SIMM

**3 -1** Make sure the orientation is correct.

Make sure that the cutout on the SIMM module is aligned with the protruding "key" on the connector slot.

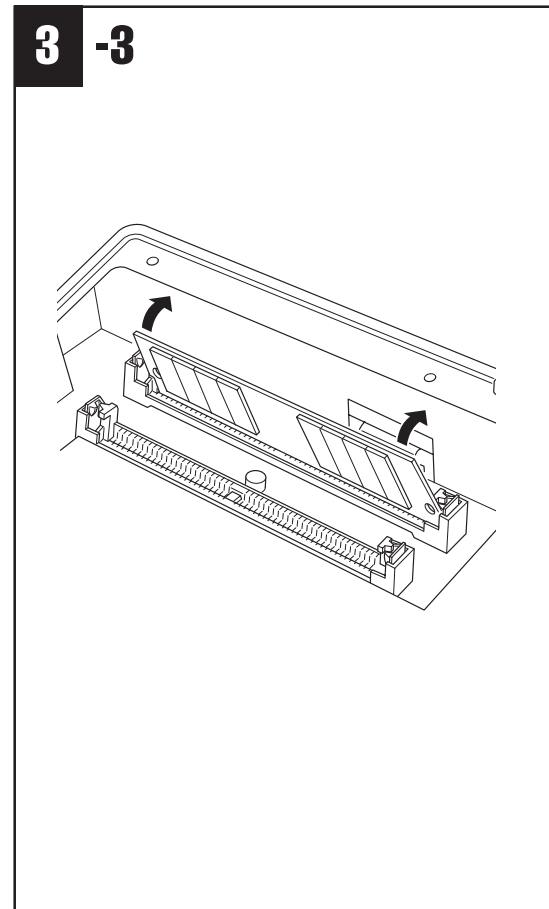
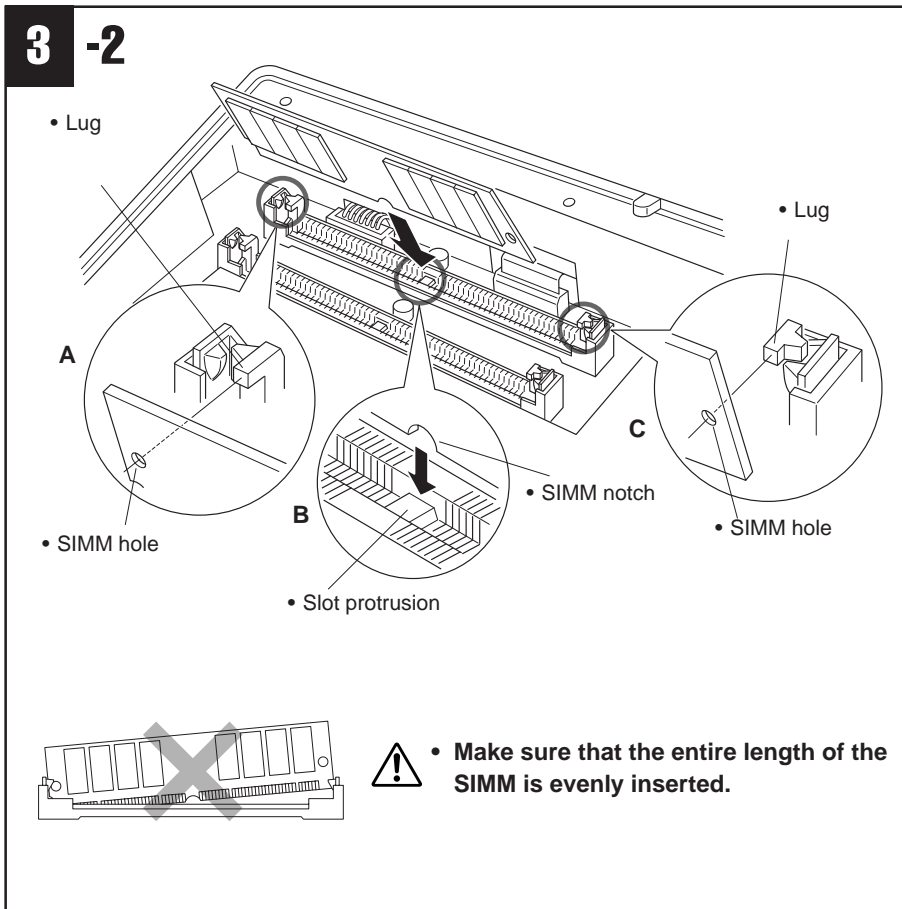

**3 -2** Install the first SIMM in the REAR SLOT (the slot closest to the PSR-8000 rear panel), inserting it at an angle as shown in the illustration. Make sure that the parts at locations A, B, and C are properly aligned.

**3 -3** Holding both edges of the SIMM module, raise it to the vertical position until it is firmly clamped by the left and right stoppers.

### Second SIMM

After confirming the orientation, insert the second SIMM into the FRONT SLOT (the slot closest to the PSR-8000 keyboard), and raise it to the vertical position in the same way as the first SIMM.

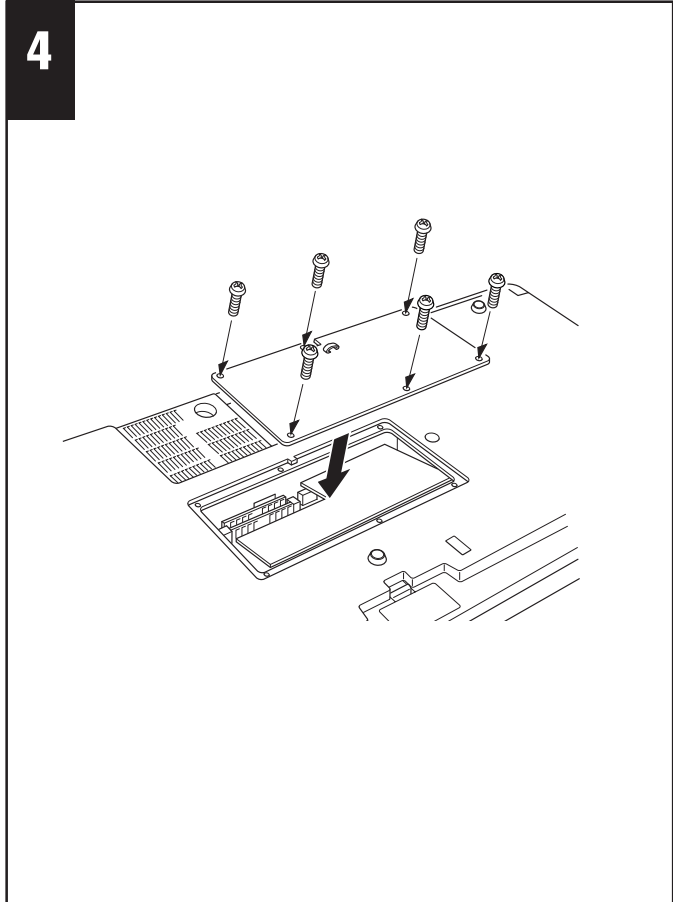
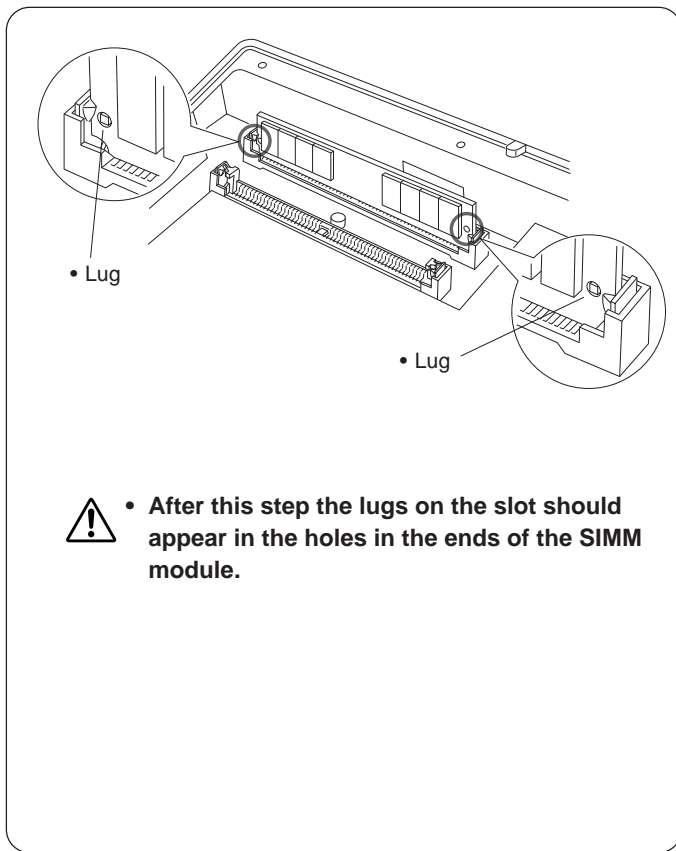

**4** Replace the SIMM cover and attach with the six screws. Install the backup batteries, set the PSR-8000 right-side up, and connect the power cord to the rear-panel AC INLET jack and an AC outlet.

**5** Check that the installed SIMMs are functioning properly. Turn on the power, go to the SAMPLING display, and check that the REMAIN TIME value matches the amount of installed memory, as follows:

4MB x 2	106.9s
8MB x 2	202.1s
16MB x 2	392.3s
No SIMMS	11.8s

(these values apply when there is no data in the wave memory)

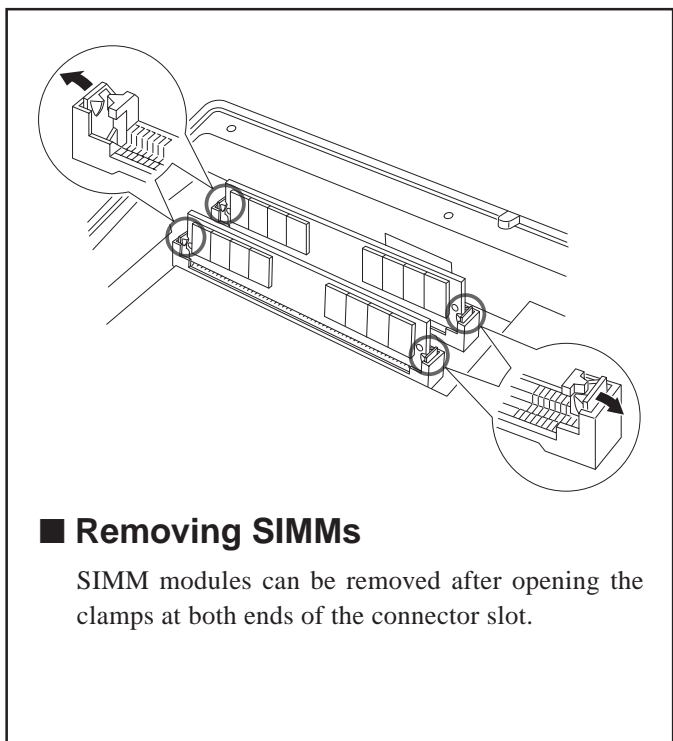

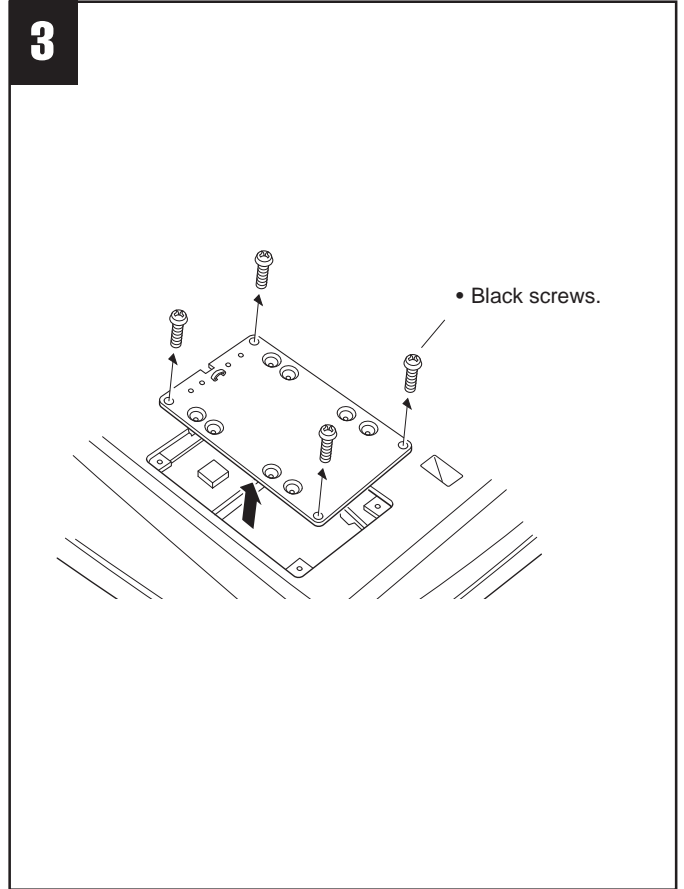
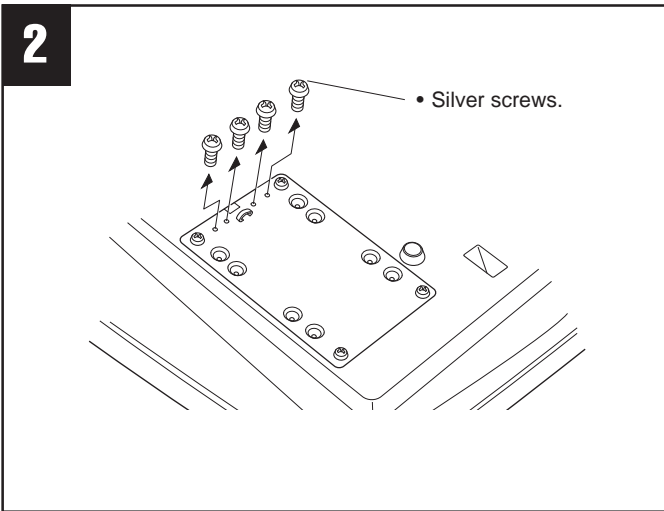
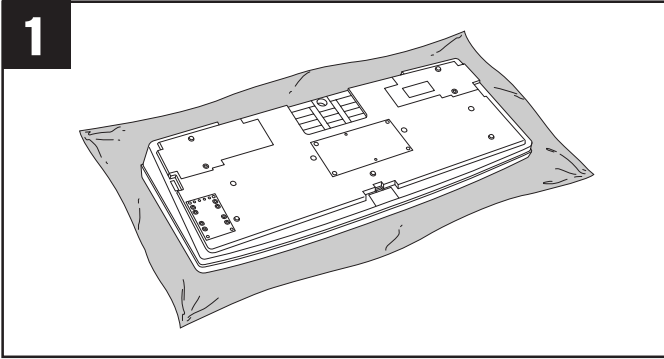

## ■ Hard Disk

The hard disk used must be a 2.5 inch IDE compatible type with a capacity of 815 megabytes or more, but some types may have different mounting requirements or may not function properly. Yamaha recommends the following hard disk units:

*Toshiba MK0803MAT*  
*Toshiba MK1003MAV*  
*Fujitsu M2724TAM*

### NOTE

- The maximum effective use of any hard disk used with the PSR-8000 will be 780 megabytes, even if the hard disk itself has higher capacity.

Please note that these recommendations may be changed at a later date. Ask your nearest Yamaha representative or an authorized distributor listed at the end of this owner's manual for information on the latest hard disk recommendations.

Install a hard disk at your own risk. Yamaha will not be held responsible for any damage or injury resulting from improper installation or the use of a hard disk other than one of the types recommended by Yamaha.

## Optional Hard Disk Installation

- 1** Before installing the hard disk be sure to save any important data to floppy disk by using the SAVE TO DISK function described on page 141. Also remove the backup batteries.  
Turn the PSR-8000 power OFF and unplug the power cord from both the AC wall socket and the instrument's rear panel. Turn the instrument upside down and rest it on a blanket or other soft surface.
- 2** Remove the four silver screws from the edge of the hard disk cover in the corner of the instrument's bottom panel. These will be used later to attach the hard disk (step **5**).
- 3** Remove the four black screws from the corners of the hard disk cover, and remove the cover.

4

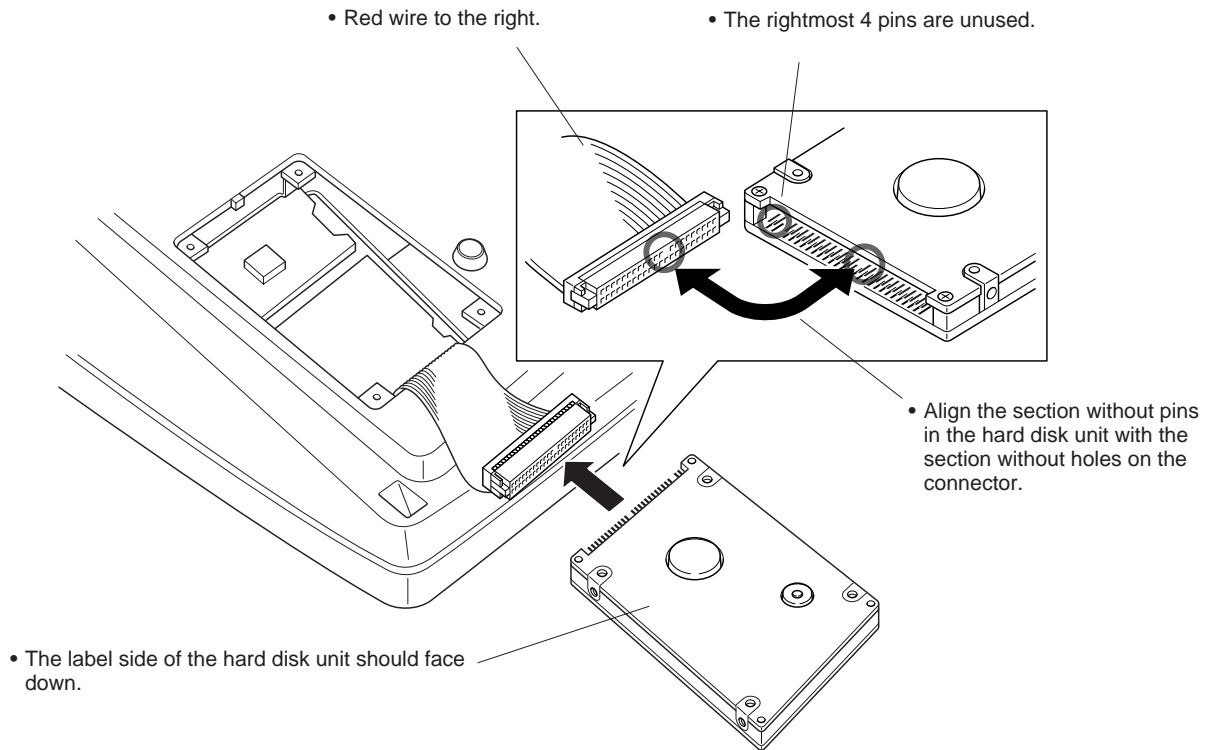

- 4** Pull the connector out from the hard disk recess, and connect it to the hard disk unit as shown in the illustration.

**CAUTION**

- Four of the pins on the hard disk unit are not used. Refer to the illustration carefully to ensure proper connection.

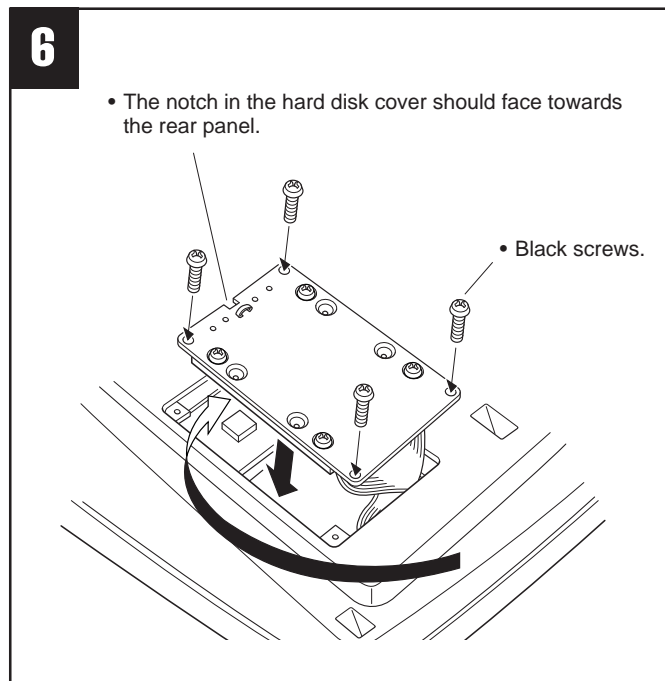
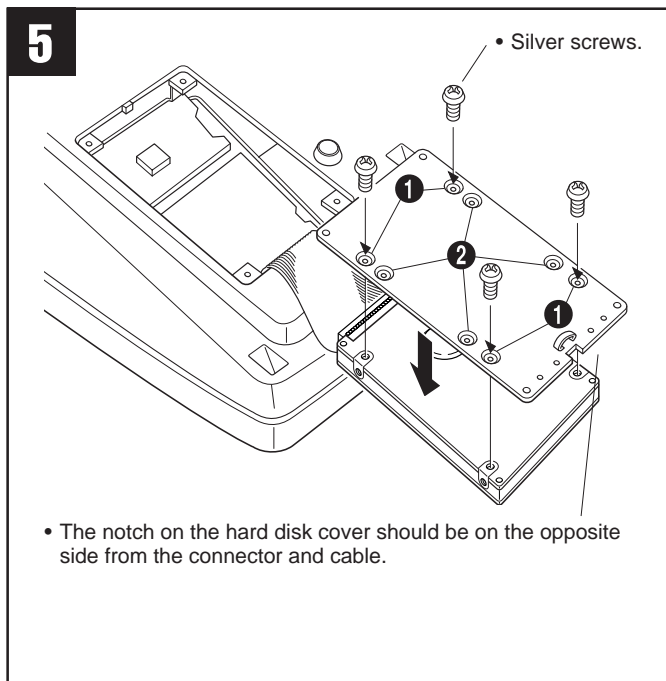

**5** Attach the hard disk unit to the hard disk cover using the four silver screws removed from the hard disk cover in step **2**.

Depending on the type of hard disk drive you plan to install, select holes **1** or holes **2** to attach the hard disk drive.

\* Holes **1** are used in this illustration.

**CAUTION**

• Be careful not to drop any screws inside the instrument during installation (this can be prevented by keeping the hard disk unit and cover away from the instrument while attaching). If this does happen, be sure to remove the screw(s) from inside the unit before turning the power on. Loose screws inside the instrument can cause improper operation or serious damage. If you are unable to retrieve a dropped screw, consult your Yamaha dealer for advice.

**6** Replace the hard disk cover, and attach with the four black screws removed in step **3**. Install the backup batteries, set the PSR-8000 right-side up, and connect the power cord to the rear-panel AC INLET jack and an AC outlet.

**7** Check that the installed hard disk is functioning properly. Turn on the power, go to the DISK display, and execute the FORMAT HARD DISK function. If the format is completed with no trouble, the hard disk is OK.

# Voice List

Category	No.		Voice Names	Voice #		
	Preset 1 Order	Preset 2 Order		MSB#	LSB#	Program Change#
Piano	1	1	Grand Piano	0	112	0
	2	2	BrightPiano	0	112	1
	3	7	Harpsichord	0	112	6
	4	8	GrandHarpsi	0	113	6
	5	4	Honky Tonk	0	112	3
	6	3	Rock Piano	0	114	2
	7	5	Midi Grand	0	112	2
	8	6	CP 80	0	113	2
E.Piano	9	9	Galaxy EP	0	114	4
	10	16	Stage EP	0	117	4
	11	14	New Tines	0	116	5
	12	17	Funk EP	0	112	4
	13	11	DX Modern	0	112	5
	14	19	Vintage EP	0	116	4
	15	13	Modern EP	0	115	5
	16	18	Tremolo EP	0	113	4
	17	15	Hyper Tines	0	113	5
	18	20	Clavi	0	112	7
	19	12	Super DX	0	117	5
	20	10	Venus EP	0	114	5
	21	21	Wah Clavi	0	113	7
Organ	22	22	Rotor Organ	0	117	18
	23	28	Dance Organ	0	113	17
	24	24	Purple Org	0	114	18
	25	26	Rock Organ1	0	113	18
	26	31	Jazz Organ1	0	112	16
	27	36	DrawbarOrg	0	115	16
	28	27	Rock Organ2	0	112	18
	29	33	VintageOrg	0	118	18
	30	38	Elec.Organ	0	118	17
	31	25	Full Rocker	0	115	18
	32	23	RotaryDrive	0	116	18
	33	29	Mellow Draw	0	117	17
	34	34	Click Organ	0	112	17
	35	30	Comp. Organ	0	115	17
	36	32	Jazz Organ2	0	113	16
	37	37	Bright Draw	0	116	16
	38	35	Perc.Organ	0	120	17
	39	39	60's Organ	0	116	17
	40	40	TheatreOrg1	0	114	16
	41	41	TheatreOrg2	0	114	17
	42	42	Pipe Organ	0	112	19
	43	43	ChapelOrgan	0	113	19
44	44	Reed Organ	0	112	20	
Accordion	45	45	Musette	0	112	21
	46	46	Tutti Accrd	0	113	21
	47	51	Small Accrd	0	115	21
	48	47	Accordion	0	116	21
	49	48	Tango Accrd	0	112	23
	50	52	Modern Harp	0	113	22
	51	54	Harmonica	0	112	22
	52	50	Bandoneon	0	113	23
	53	49	Soft Accrd	0	114	21
	54	53	Blues Harp	0	114	22

Category	No.		Voice Names	Voice #			
	Preset 1 Order	Preset 2 Order		MSB#	LSB#	Program Change#	
Guitars	55	56	Spanish Gtr	0	113	24	
	56	58	12StrGuitar	0	113	25	
	57	64	SolidGuitar	0	118	27	
	58	62	Solid Chord	0	121	27	
	59	75	Crunch Gtr	0	113	30	
	60	69	Funk Guitar	0	113	28	
	61	65	VintageTrem	0	120	27	
	62	71	Jazz Guitar	0	112	26	
	63	74	HawaiianGtr	0	114	26	
	64	77	FeedbackGtr	0	113	29	
	65	55	Classic Gtr	0	112	24	
	66	57	Folk Guitar	0	112	25	
	67	61	CleanGuitar	0	112	27	
	68	80	Mandolin	0	114	25	
	69	76	StackCrunch	0	114	30	
	70	68	MutedGuitar	0	112	28	
	71	66	Tremolo Gtr	0	113	27	
	72	72	Octave Gtr	0	113	26	
	73	73	PedalSteel	0	115	27	
	74	78	Distortion	0	112	30	
	75	67	Wah Guitar	0	122	27	
	76	60	Elec.12Str	0	119	27	
	77	63	60's Clean	0	117	27	
	78	59	BrightClean	0	116	27	
	79	79	Overdrive	0	112	29	
	80	70	Slap Guitar	0	114	27	
	81	81	UprightBass	0	113	32	
	82	86	FingerBass	0	112	33	
	83	88	Pick Bass	0	112	34	
	84	84	Jaco Bass	0	113	35	
	85	89	Slap Bass	0	112	36	
	86	92	Analog Bass	0	112	39	
	87	93	Touch Bass	0	115	39	
	88	96	Hi Q Bass	0	113	38	
	89	94	Rave Bass	0	114	38	
	90	87	Fusion Bass	0	113	36	
	91	82	Aco.Bass	0	112	32	
	92	99	Organ Bass	0	119	17	
	93	90	Funk Bass	0	112	37	
	94	85	Fretless	0	112	35	
	95	91	Dance Bass	0	113	39	
	96	83	Bass&Cymbal	0	114	32	
	97	95	Synth Bass	0	112	38	
	98	98	Snap Bass	0	114	39	
	99	97	Click Bass	0	115	38	
	Strings	100	106	Strings	0	112	48
		101	107	OrchStrings	0	113	48
		102	108	Symphon.Str	0	114	48
103		109	Bow Strings	0	116	48	
104		100	Solo Violin	0	112	40	
105		110	SlowStrings	0	113	49	
106		111	ConcertoStr	0	115	48	
107		112	ChamberStrs	0	112	49	
108		113	TremoloStrs	0	112	44	

# Voice List

Category	No.		Voice Names	Voice #		
	Preset 1 Order	Preset 2 Order		MSB#	LSB#	Program Change#
	109	117	Analog Strs	0	112	51
	110	101	Soft Violin	0	113	40
	111	102	Viola	0	112	41
	112	104	Cello	0	112	42
	113	105	Contrabass	0	112	43
	114	120	Harp	0	112	46
	115	114	Str.Quartet	0	114	49
	116	115	MarcatoStrs	0	115	49
	117	116	PizzStrings	0	112	45
	118	119	Orch.Hit	0	112	55
	119	118	Syn Strings	0	112	50
	120	121	Hackbrett	0	113	46
	121	103	Fiddle	0	112	110
	122	125	Banjo	0	112	105
	123	122	Sitar	0	112	104
	124	123	Koto	0	112	107
	125	124	Shamisen	0	112	106
Trumpet	126	126	Sweet Trump	0	115	56
	127	128	SoftTrumpet	0	114	56
	128	127	JazzTrumpet	0	116	56
	129	132	Muted Trump	0	112	59
	130	129	SoloTrumpet	0	112	56
	131	130	Air Trumpet	0	117	56
	132	131	Flugel Horn	0	113	56
	133	133	Trombone	0	116	57
	134	134	Solo Tromb	0	112	57
	135	135	Soft Tromb	0	115	57
	136	136	MellowTromb	0	114	57
	137	137	French Horn	0	112	60
	138	138	Tuba	0	112	58
Brass	139	139	BrasSection	0	112	61
	140	144	BigBandBrs	0	113	61
	141	146	Big Brass	0	121	61
	142	152	MellowBrass	0	116	61
	143	153	Pop Brass	0	118	61
	144	143	Step Brass	0	124	61
	145	147	Soft Brass	0	123	61
	146	140	BrightBrass	0	120	61
	147	154	Jump Brass	0	113	62
	148	158	TechnoBrass	0	114	62
	149	145	Full Horns	0	114	61
	150	149	Brass Combo	0	115	66
	151	151	MellowHorns	0	119	61
	152	141	Trumpet Ens	0	122	61
	153	150	BallroomBrs	0	113	59
	154	156	Analog Brs	0	112	63
	155	148	Trb.Section	0	113	57
	156	142	High Brass	0	115	61
	157	155	Synth Brass	0	112	62
	158	157	Small Brass	0	117	61
Saxphone	159	164	Sweet Tenor	0	117	66
	160	170	Sweet Clari	0	114	71
	161	161	Sweet Alto	0	114	65
	162	166	Growl Sax	0	118	66
	163	165	BreathTenor	0	114	66
	164	162	BreathyAlto	0	113	65
	165	159	Soprano Sax	0	112	64

Category	No.		Voice Names	Voice #		
	Preset 1 Order	Preset 2 Order		MSB#	LSB#	Program Change#
	166	175	Sax Section	0	116	66
	167	171	MelClarinet	0	113	71
	168	168	Rock Bari	0	113	67
	169	160	Alto Sax	0	112	65
	170	163	Tenor Sax	0	112	66
	171	167	BaritoneSax	0	112	67
	172	176	WoodwindEns	0	113	66
	173	172	Oboe	0	112	68
	174	173	EnglishHorn	0	112	69
	175	174	Bassoon	0	112	70
	176	169	Clarinet	0	112	71
Flute	177	177	Sweet Flute	0	114	73
	178	180	Pan Flute	0	112	75
	179	178	Flute	0	112	73
	180	179	Piccolo	0	112	72
	181	181	EthnicFlute	0	113	73
	182	182	Shakuhachi	0	112	77
	183	186	Whistle	0	112	78
	184	184	Recorder	0	112	74
	185	183	Ocarina	0	112	79
	186	185	Bagpipe	0	112	109
Choir&Pad	187	187	Hah Choir	0	114	52
	188	199	Insomnia	0	113	94
	189	215	Cyber Pad	0	113	99
	190	217	Wave 2001	0	112	95
	191	188	Gothic Vox	0	113	53
	192	196	Equinox	0	112	94
	193	195	Xenon Pad	0	112	91
	194	218	Skydiver	0	112	101
	195	220	Far East	0	112	97
	196	221	Template	0	114	95
	197	214	Atmosphere	0	112	99
	198	189	Voices	0	113	54
	199	212	Glass Pad	0	114	93
	200	206	Fantasia	0	112	88
	201	213	DX Pad	0	112	92
	202	207	Symbiont	0	113	88
	203	208	Stargate	0	114	88
	204	200	Krypton	0	112	90
	205	201	Loch Ness	0	112	93
	206	194	Air Choir	0	112	54
	207	204	Area 51	0	112	89
	208	193	Vocal Ensbl	0	113	52
	209	190	Choir	0	112	52
	210	203	Dark Moon	0	113	89
	211	198	Ionosphere	0	115	94
	212	191	Vox Humana	0	112	53
	213	209	Golden Age	0	115	88
	214	202	Phase IV	0	113	93
	215	197	Solaris	0	114	94
	216	210	Time Travel	0	116	88
	217	211	Millenium	0	117	88
	218	219	Transform	0	113	95
	219	216	Baroque	0	112	103
	220	205	Dunes	0	114	89
	221	192	Uuh Choir	0	115	52



Category	No.		Voice Names	Voice #		
	Preset 1 Order	Preset 2 Order		MSB#	LSB#	Program Change#
Synthesizer	222	233	Fire Wire	0	116	81
	223	238	Analogon	0	115	81
	224	241	Adrenaline	0	113	84
	225	223	Vintage Ld	0	113	80
	226	240	Vinylead	0	115	80
	227	236	Fargo	0	119	81
	228	234	Wire Lead	0	120	81
	229	243	Portatone	0	112	84
	230	232	Blaster	0	114	81
	231	247	Synchronize	0	112	96
	232	231	Big Lead	0	113	81
	233	239	Impact	0	113	87
	234	242	Funky Lead	0	121	81
	235	222	Square Lead	0	112	80
	236	245	Stardust	0	112	98
	237	230	Saw.Lead	0	112	81
	238	226	Aero Lead	0	112	83
	239	228	Tiny Lead	0	118	80
	240	225	Mini Lead	0	114	80
	241	248	Rhythmatic	0	113	96
	242	227	Synth Flute	0	119	80
	243	244	Sub Aqua	0	118	81
	244	235	Warp	0	117	81
	245	224	Meta Wood	0	117	80
	246	246	Sun Bell	0	113	98
	247	237	Under Heim	0	112	87
	248	229	Hi Bias	0	116	80
	249	249	Clockwork	0	114	96
	Percussion	250	263	Vibraphone	0	112
251		264	Jazz Vibes	0	113	11
252		265	Marimba	0	112	12
253		266	Xylophone	0	112	13
254		267	Steel Drums	0	112	114
255		268	Celesta	0	112	8
256		269	Glocken	0	112	9
257		270	Music Box	0	112	10
258		271	TubularBell	0	112	14
259		272	Kalimba	0	112	108
260		273	Timpani	0	112	47
261		274	Dulcimer	0	112	15
262		250	Std.Kit1	127	0	0
263		251	Std.Kit2	127	0	1
264		252	Hit Kit	127	0	4
265		253	Room Kit	127	0	8
266		254	Rock Kit	127	0	16
267		255	Electro Kit	127	0	24
268		256	Analog Kit	127	0	25
269		257	Dance Kit	127	0	27
270		258	Jazz Kit	127	0	32
271		259	Brush Kit	127	0	40
272		260	Classic Kit	127	0	48
273		261	SFX Kit1	126	0	0
274		262	SFX Kit2	126	0	1

Category	No.		Voice Names	Voice #		
	Preset 1 Order	Preset 2 Order		MSB#	LSB#	Program Change#
XG	275	275	GrandPno	0	0	0
	276	276	GrndPnoK	0	1	0
	277	277	MelloGrP	0	18	0
	278	278	PianoStr	0	40	0
	279	279	Dream	0	41	0
	280	280	BritePno	0	0	1
	281	281	BritPnoK	0	1	1
	282	282	E.Grand	0	0	2
	283	283	EIGrPnoK	0	1	2
	284	284	Det.CP80	0	32	2
	285	285	EIGrPno1	0	40	2
	286	286	EIGrPno2	0	41	2
	287	287	HnkyTonk	0	0	3
	288	288	HnkyTnkK	0	1	3
	289	289	E.Piano1	0	0	4
	290	290	EI.Pno1K	0	1	4
	291	291	MelloEP1	0	18	4
	292	292	Chor.EP1	0	32	4
	293	293	HardEI.P	0	40	4
	294	294	VX EI.P1	0	45	4
	295	295	60sEI.P	0	64	4
	296	296	E.Piano2	0	0	5
	297	297	EI.Pno2K	0	1	5
	298	298	Chor.EP2	0	32	5
	299	299	DX Hard	0	33	5
	300	300	DXLegend	0	34	5
	301	301	DX Phase	0	40	5
	302	302	DX+Analg	0	41	5
	303	303	DXKotoEP	0	42	5
	304	304	VX EI.P2	0	45	5
	305	305	Harpsi.	0	0	6
306	306	Harpsi.K	0	1	6	
307	307	Harpsi.2	0	25	6	
308	308	Harpsi.3	0	35	6	
309	309	Clavi.	0	0	7	
310	310	Clavi. K	0	1	7	
311	311	ClaviWah	0	27	7	
312	312	PulseClv	0	64	7	
313	313	PierceCl	0	65	7	
314	314	Celesta	0	0	8	
315	315	Glocken	0	0	9	
316	316	MusicBox	0	0	10	
317	317	Orgel	0	64	10	
318	318	Vibes	0	0	11	
319	319	VibesK	0	1	11	
320	320	HardVibe	0	45	11	
321	321	Marimba	0	0	12	
322	322	MarimbaK	0	1	12	
323	323	SineMrmb	0	64	12	
324	324	Balafon2	0	97	12	
325	325	Log Drum	0	98	12	
326	326	Xylophon	0	0	13	
327	327	TubulBel	0	0	14	
328	328	ChrchBel	0	96	14	
329	329	Carillon	0	97	14	
330	330	Dulcimer	0	0	15	
331	331	Dulcimr2	0	35	15	

# Voice List

Category	No.		Voice Names	Voice #		
	Preset 1 Order	Preset 2 Order		MSB#	LSB#	Program Change#
XG	332	332	Cimbalom	0	96	15
	333	333	Santur	0	97	15
	334	334	DrawOrgn	0	0	16
	335	335	DetDrwOr	0	32	16
	336	336	60sDrOr1	0	33	16
	337	337	60sDrOr2	0	34	16
	338	338	70sDrOr1	0	35	16
	339	339	DrawOrg2	0	36	16
	340	340	60sDrOr3	0	37	16
	341	341	EvenBar	0	38	16
	342	342	16+2'2/3	0	40	16
	343	343	Organ Ba	0	64	16
	344	344	70sDrOr2	0	65	16
	345	345	CheezOrg	0	66	16
	346	346	DrawOrg3	0	67	16
	347	347	PercOrg	0	0	17
	348	348	70sPcOr1	0	24	17
	349	349	DetPrcOr	0	32	17
	350	350	LiteOrg	0	33	17
	351	351	PercOrg2	0	37	17
	352	352	RockOrgn	0	0	18
	353	353	RotaryOr	0	64	18
	354	354	SloRotar	0	65	18
	355	355	FstRotar	0	66	18
	356	356	ChrchOrg	0	0	19
	357	357	ChurOrg3	0	32	19
	358	358	ChurOrg2	0	35	19
	359	359	NotreDam	0	40	19
	360	360	OrgFlute	0	64	19
	361	361	TrmOrgFl	0	65	19
	362	362	ReedOrgn	0	0	20
	363	363	Puff Org	0	40	20
	364	364	Acordion	0	0	21
	365	365	AccordIt	0	32	21
	366	366	Harmnica	0	0	22
	367	367	Harmo 2	0	32	22
	368	368	TangoAcd	0	0	23
	369	369	TngoAcd2	0	64	23
370	370	NylonGtr	0	0	24	
371	371	NylonGt2	0	16	24	
372	372	NylonGt3	0	25	24	
373	373	VelGtHrm	0	43	24	
374	374	Ukulele	0	96	24	
375	375	SteelGtr	0	0	25	
376	376	SteelGt2	0	16	25	
377	377	12StrGtr	0	35	25	
378	378	Nyln&Stl	0	40	25	
379	379	Stl&Body	0	41	25	
380	380	Mandolin	0	96	25	
381	381	Jazz Gtr	0	0	26	
382	382	MelloGtr	0	18	26	
383	383	JazzAmp	0	32	26	
384	384	CleanGtr	0	0	27	
385	385	ChorusGt	0	32	27	
386	386	Mute.Gtr	0	0	28	
387	387	FunkGtr1	0	40	28	
388	388	MuteStlG	0	41	28	

Category	No.		Voice Names	Voice #		
	Preset 1 Order	Preset 2 Order		MSB#	LSB#	Program Change#
XG	389	389	FunkGtr2	0	43	28
	390	390	Jazz Man	0	45	28
	391	391	Ovrdrive	0	0	29
	392	392	Gt.Pinrch	0	43	29
	393	393	Dist.Gtr	0	0	30
	394	394	FeedbkGt	0	40	30
	395	395	FeedbGt2	0	41	30
	396	396	GtrHarmo	0	0	31
	397	397	GtFeedbk	0	65	31
	398	398	GtrHrmo2	0	66	31
	399	399	Aco.Bass	0	0	32
	400	400	JazzRthm	0	40	32
	401	401	VXUprght	0	45	32
	402	402	FngrBass	0	0	33
	403	403	FngrDrk	0	18	33
	404	404	FlangeBa	0	27	33
	405	405	Ba&DstEG	0	40	33
	406	406	FngrSlap	0	43	33
	407	407	FngBass2	0	45	33
	408	408	ModAlem	0	65	33
	409	409	PickBass	0	0	34
	410	410	MutePkBa	0	28	34
	411	411	Fretless	0	0	35
	412	412	Fretles2	0	32	35
	413	413	Fretles3	0	33	35
	414	414	Fretles4	0	34	35
	415	415	SynFretl	0	96	35
	416	416	Smooth	0	97	35
	417	417	SlapBas1	0	0	36
	418	418	ResoSlap	0	27	36
	419	419	PunchThm	0	32	36
	420	420	SlapBas2	0	0	37
	421	421	VeloSlap	0	43	37
	422	422	SynBass1	0	0	38
	423	423	SynBa1Dk	0	18	38
	424	424	FastResB	0	20	38
	425	425	AcidBass	0	24	38
	426	426	Clv Bass	0	35	38
	427	427	TeknoBa	0	40	38
	428	428	Oscar	0	64	38
	429	429	SqrBass	0	65	38
	430	430	RubberBa	0	66	38
	431	431	Hammer	0	96	38
	432	432	SynBass2	0	0	39
	433	433	MelloSB1	0	6	39
434	434	Seq Bass	0	12	39	
435	435	ClkSynBa	0	18	39	
436	436	SynBa2Dk	0	19	39	
437	437	SmthBa 2	0	32	39	
438	438	ModulrBa	0	40	39	
439	439	DX Bass	0	41	39	
440	440	X WireBa	0	64	39	
441	441	Violin	0	0	40	
442	442	SlowVln	0	8	40	
443	443	Viola	0	0	41	
444	444	Cello	0	0	42	
445	445	Contrabs	0	0	43	

Category	No.		Voice Names	Voice #		
	Preset 1 Order	Preset 2 Order		MSB#	LSB#	Program Change#
XG	446	446	Trem.Str	0	0	44
	447	447	SlowTrStr	0	8	44
	448	448	Susp Str	0	40	44
	449	449	Pizz.Str	0	0	45
	450	450	Harp	0	0	46
	451	451	YangChin	0	40	46
	452	452	Timpani	0	0	47
	453	453	Strings1	0	0	48
	454	454	S.Strngs	0	3	48
	455	455	SlowStr	0	8	48
	456	456	ArcoStr	0	24	48
	457	457	60sStrng	0	35	48
	458	458	Orchestr	0	40	48
	459	459	Orchstr2	0	41	48
	460	460	TremOrch	0	42	48
	461	461	VeloStr	0	45	48
	462	462	Strings2	0	0	49
	463	463	S.SlwStr	0	3	49
	464	464	LegatoSt	0	8	49
	465	465	Warm Str	0	40	49
	466	466	Kingdom	0	41	49
	467	467	70s Str	0	64	49
	468	468	Str Ens3	0	65	49
	469	469	Syn.Str1	0	0	50
	470	470	ResoStr	0	27	50
	471	471	Syn Str4	0	64	50
	472	472	SS Str	0	65	50
	473	473	Syn.Str2	0	0	51
	474	474	ChoirAah	0	0	52
	475	475	S.Choir	0	3	52
	476	476	Ch.Aahs2	0	16	52
	477	477	MelChoir	0	32	52
	478	478	ChoirStr	0	40	52
	479	479	VoiceOoh	0	0	53
	480	480	SynVoice	0	0	54
	481	481	SynVox2	0	40	54
	482	482	Choral	0	41	54
	483	483	AnaVoice	0	64	54
	484	484	Orch.Hit	0	0	55
	485	485	OrchHit2	0	35	55
	486	486	Impact	0	64	55
	487	487	Trumpet	0	0	56
	488	488	Trumpet2	0	16	56
	489	489	BriteTrp	0	17	56
	490	490	WarmTrp	0	32	56
	491	491	Trombone	0	0	57
	492	492	Trmbone2	0	18	57
	493	493	Tuba	0	0	58
	494	494	Tuba 2	0	16	58
	495	495	Mute.Trp	0	0	59
	496	496	Fr.Horn	0	0	60
	497	497	FrHrSolo	0	6	60
498	498	FrHorn2	0	32	60	
499	499	HornOrch	0	37	60	
500	500	BrasSect	0	0	61	
501	501	Tp&TbSec	0	35	61	
502	502	BrssSec2	0	40	61	

Category	No.		Voice Names	Voice #		
	Preset 1 Order	Preset 2 Order		MSB#	LSB#	Program Change#
XG	503	503	HiBrass	0	41	61
	504	504	MelloBrs	0	42	61
	505	505	SynBras1	0	0	62
	506	506	QuackBr	0	12	62
	507	507	RezSynBr	0	20	62
	508	508	PolyBrss	0	24	62
	509	509	SynBras3	0	27	62
	510	510	JumpBrss	0	32	62
	511	511	AnaVelBr	0	45	62
	512	512	AnaBrss1	0	64	62
	513	513	SynBras2	0	0	63
	514	514	Soft Brs	0	18	63
	515	515	SynBrss4	0	40	63
	516	516	ChoirBrs	0	41	63
	517	517	VelBrss2	0	45	63
	518	518	AnaBrss2	0	64	63
	519	519	SprnoSax	0	0	64
	520	520	Alto Sax	0	0	65
	521	521	Sax Sect	0	40	65
	522	522	HyprAlto	0	43	65
	523	523	TenorSax	0	0	66
	524	524	BrthTnSx	0	40	66
	525	525	SoftTenr	0	41	66
	526	526	TnrSax 2	0	64	66
	527	527	Bari.Sax	0	0	67
	528	528	Oboe	0	0	68
	529	529	Eng.Horn	0	0	69
	530	530	Bassoon	0	0	70
	531	531	Clarinet	0	0	71
	532	532	Piccolo	0	0	72
	533	533	Flute	0	0	73
	534	534	Recorder	0	0	74
	535	535	PanFlute	0	0	75
	536	536	Bottle	0	0	76
	537	537	Shakhchi	0	0	77
	538	538	Whistle	0	0	78
	539	539	Ocarina	0	0	79
	540	540	SquareLd	0	0	80
	541	541	Square 2	0	6	80
	542	542	LMSquare	0	8	80
	543	543	Hollow	0	18	80
	544	544	Shmoog	0	19	80
	545	545	Mellow	0	64	80
	546	546	SoloSine	0	65	80
	547	547	SineLead	0	66	80
	548	548	Saw.Lead	0	0	81
	549	549	Saw 2	0	6	81
	550	550	ThickSaw	0	8	81
	551	551	DynaSaw	0	18	81
	552	552	DigiSaw	0	19	81
	553	553	Big Lead	0	20	81
	554	554	HeavySyn	0	24	81
	555	555	WaspySyn	0	25	81
	556	556	PulseSaw	0	40	81
	557	557	Dr. Lead	0	41	81
	558	558	VeloLead	0	45	81
	559	559	Seq Ana	0	96	81

# Voice List

Category	No.		Voice Names	Voice #		
	Preset 1 Order	Preset 2 Order		MSB#	LSB#	Program Change#
XG	560	560	CaliopLd	0	0	82
	561	561	Pure Pad	0	65	82
	562	562	Chiff Ld	0	0	83
	563	563	Rubby	0	64	83
	564	564	CharanLd	0	0	84
	565	565	DistLead	0	64	84
	566	566	WireLead	0	65	84
	567	567	Voice Ld	0	0	85
	568	568	SynthAah	0	24	85
	569	569	VoxLead	0	64	85
	570	570	Fifth Ld	0	0	86
	571	571	Big Five	0	35	86
	572	572	Bass &Ld	0	0	87
	573	573	Big&Low	0	16	87
	574	574	Fat&Prky	0	64	87
	575	575	SoftWurl	0	65	87
	576	576	NewAgePd	0	0	88
	577	577	Fantasy2	0	64	88
	578	578	Warm Pad	0	0	89
	579	579	ThickPad	0	16	89
	580	580	Soft Pad	0	17	89
	581	581	SinePad	0	18	89
	582	582	Horn Pad	0	64	89
	583	583	RotarStr	0	65	89
	584	584	PolySyPd	0	0	90
	585	585	PolyPd80	0	64	90
	586	586	ClickPad	0	65	90
	587	587	Ana Pad	0	66	90
	588	588	SquarPad	0	67	90
	589	589	ChoirPad	0	0	91
	590	590	Heaven2	0	64	91
	591	591	ltopia	0	66	91
	592	592	CC Pad	0	67	91
	593	593	BowedPad	0	0	92
	594	594	Glacier	0	64	92
	595	595	GlassPad	0	65	92
	596	596	MetalPad	0	0	93
	597	597	Tine Pad	0	64	93
	598	598	Pan Pad	0	65	93
	599	599	Halo Pad	0	0	94
	600	600	SweepPad	0	0	95
	601	601	Shwimmer	0	20	95
	602	602	Converge	0	27	95
	603	603	PolarPad	0	64	95
	604	604	Celstial	0	66	95
	605	605	Rain	0	0	96
	606	606	ClaviPad	0	45	96
	607	607	HrmoRain	0	64	96
	608	608	AfrcnWnd	0	65	96
	609	609	Caribbean	0	66	96
	610	610	SoundTrk	0	0	97
	611	611	Prologue	0	27	97
	612	612	Ancestrl	0	64	97
	613	613	Crystal	0	0	98
	614	614	SynDrCmp	0	12	98
	615	615	Popcorn	0	14	98
	616	616	TinyBell	0	18	98

Category	No.		Voice Names	Voice #		
	Preset 1 Order	Preset 2 Order		MSB#	LSB#	Program Change#
XG	617	617	RndGlock	0	35	98
	618	618	GlockChi	0	40	98
	619	619	ClearBel	0	41	98
	620	620	ChorBell	0	42	98
	621	621	SynMalet	0	64	98
	622	622	SftCryst	0	65	98
	623	623	LoudGlok	0	66	98
	624	624	XmasBell	0	67	98
	625	625	VibeBell	0	68	98
	626	626	DigiBell	0	69	98
	627	627	AirBells	0	70	98
	628	628	BellHarp	0	71	98
	629	629	Gamelmba	0	72	98
	630	630	Atmosphr	0	0	99
	631	631	WarmAtms	0	18	99
	632	632	HollwRls	0	19	99
	633	633	NylonEP	0	40	99
	634	634	NylnHarp	0	64	99
	635	635	Harp Vox	0	65	99
	636	636	AtmosPad	0	66	99
	637	637	Planet	0	67	99
	638	638	Bright	0	0	100
	639	639	FantaBel	0	64	100
	640	640	Smokey	0	96	100
	641	641	Goblins	0	0	101
	642	642	GobSyn	0	64	101
	643	643	50sSciFi	0	65	101
	644	644	Ring Pad	0	66	101
	645	645	Ritual	0	67	101
	646	646	ToHeaven	0	68	101
	647	647	Night	0	70	101
	648	648	Glisten	0	71	101
	649	649	BelChoir	0	96	101
	650	650	Echoes	0	0	102
	651	651	EchoPad2	0	8	102
	652	652	Echo Pan	0	14	102
	653	653	EchoBell	0	64	102
	654	654	Big Pan	0	65	102
	655	655	SynPiano	0	66	102
	656	656	Creation	0	67	102
	657	657	Stardust	0	68	102
	658	658	Reso Pan	0	69	102
	659	659	Sci-Fi	0	0	103
	660	660	Starz	0	64	103
	661	661	Sitar	0	0	104
	662	662	DetSitar	0	32	104
	663	663	Sitar 2	0	35	104
	664	664	Tambra	0	96	104
	665	665	Tamboura	0	97	104
	666	666	Banjo	0	0	105
	667	667	MuteBnjo	0	28	105
	668	668	Rabab	0	96	105
	669	669	Gopichnt	0	97	105
	670	670	Oud	0	98	105
	671	671	Shamisen	0	0	106
	672	672	Koto	0	0	107
	673	673	T. Koto	0	96	107

Category	No.		Voice Names	Voice #		
	Preset 1 Order	Preset 2 Order		MSB#	LSB#	Program Change#
XG	674	674	Kanoon	0	97	107
	675	675	Kalimba	0	0	108
	676	676	Bagpipe	0	0	109
	677	677	Fiddle	0	0	110
	678	678	Shanai	0	0	111
	679	679	Shanai2	0	64	111
	680	680	Pungi	0	96	111
	681	681	Hichriki	0	97	111
	682	682	TnklBell	0	0	112
	683	683	Bonang	0	96	112
	684	684	Gender	0	97	112
	685	685	Gamelan	0	98	112
	686	686	S.Gamlan	0	99	112
	687	687	Rama Cym	0	100	112
	688	688	AsianBel	0	101	112
	689	689	Agogo	0	0	113
	690	690	SteelDrm	0	0	114
	691	691	GlasPerc	0	97	114
	692	692	ThaiBell	0	98	114
	693	693	WoodBlok	0	0	115
	694	694	Castanet	0	96	115
	695	695	TaikoDrm	0	0	116
	696	696	Gr.Cassa	0	96	116
	697	697	MelodTom	0	0	117
	698	698	Mel Tom2	0	64	117
	699	699	Real Tom	0	65	117
	700	700	Rock Tom	0	66	117
	701	701	Syn.Drum	0	0	118
	702	702	Ana Tom	0	64	118
	703	703	ElecPerc	0	65	118
	704	704	RevCymb1	0	0	119
	705	705	FretNoiz	0	0	120
	706	706	BrthNoiz	0	0	121
	707	707	Seashore	0	0	122
	708	708	Tweet	0	0	123
	709	709	Telephone	0	0	124
	710	710	Helicptr	0	0	125
	711	711	Applause	0	0	126
	712	712	Gunshot	0	0	127
	713	713	CuttngNz	64	0	0
	714	714	CttngNz2	64	0	1
	715	715	Str Slap	64	0	3
	716	716	Fl.KClik	64	0	16
	717	717	Rain	64	0	32
	718	718	Thunder	64	0	33
	719	719	Wind	64	0	34
720	720	Stream	64	0	35	
721	721	Bubble	64	0	36	
722	722	Feed	64	0	37	
723	723	Dog	64	0	48	
724	724	Horse	64	0	49	
725	725	Bird 2	64	0	50	
726	726	Ghost	64	0	54	
727	727	Maou	64	0	55	
728	728	Tel.Dial	64	0	64	
729	729	DoorSqek	64	0	65	
730	730	Door Slam	64	0	66	

Category	No.		Voice Names	Voice #		
	Preset 1 Order	Preset 2 Order		MSB#	LSB#	Program Change#
XG	731	731	Scratch	64	0	67
	732	732	Scratch 2	64	0	68
	733	733	WindChm	64	0	69
	734	734	Telphon2	64	0	70
	735	735	CarEngin	64	0	80
	736	736	Car Stop	64	0	81
	737	737	Car Pass	64	0	82
	738	738	CarCrash	64	0	83
	739	739	Siren	64	0	84
	740	740	Train	64	0	85
	741	741	Jetplane	64	0	86
	742	742	Starship	64	0	87
	743	743	Burst	64	0	88
	744	744	Coaster	64	0	89
	745	745	SbMarine	64	0	90
	746	746	Laughing	64	0	96
	747	747	Scream	64	0	97
	748	748	Punch	64	0	98
	749	749	Heart	64	0	99
	750	750	FootStep	64	0	100
	751	751	MchinGun	64	0	112
	752	752	LaserGun	64	0	113
	753	753	Xplosion	64	0	114
	754	754	FireWork	64	0	115

# Keyboard Drum Assignments

Bank Select MSB					127	127	127	127	127	127	127
Bank Select LSB					0	0	0	0	0	0	0
Program Change# (0-127)					0	1	4	8	16	24	25
MIDI Note#	Note	Keyboard Note	Key Off	Alternate Group	Standard Kit 1	Standard Kit 2	Hit Kit	Room Kit	Rock Kit	Electronic Kit	Analog Kit
13	C# -1	(C# 0)		3	Surdo Mute	<<<	<<<	<<<	<<<	<<<	<<<
14	D -1	(D 0)		3	Surdo Open	<<<	<<<	<<<	<<<	<<<	<<<
15	D# -1	(D# 0)			Hi Q	<<<	<<<	<<<	<<<	<<<	<<<
16	E -1	(E 0)			Whip Slap	<<<	<<<	<<<	<<<	<<<	<<<
17	F -1	(F 0)		4	Scratch H	<<<	<<<	<<<	<<<	<<<	<<<
18	F# -1	(F# 0)		4	Scratch L	<<<	<<<	<<<	<<<	<<<	<<<
19	G -1	(G 0)			Finger Snap	<<<	<<<	<<<	<<<	<<<	<<<
20	G# -1	(G# 0)			Click Noise	<<<	<<<	<<<	<<<	<<<	<<<
21	A -1	(A 0)			Metronome Click	<<<	<<<	<<<	<<<	<<<	<<<
22	A# -1	(A# 0)			Metronome Bell	<<<	<<<	<<<	<<<	<<<	<<<
23	B -1	(B 0)			Seq Click L	<<<	<<<	<<<	<<<	<<<	<<<
24	C 0	C 1			Seq Click H	<<<	<<<	<<<	<<<	<<<	<<<
25	C# 0	C# 1			Brush Tap	<<<	<<<	<<<	<<<	<<<	<<<
26	D 0	D 1	○		Brush Swirl	<<<	<<<	<<<	<<<	<<<	<<<
27	D# 0	D# 1			Brush Slap	<<<	<<<	<<<	<<<	<<<	<<<
28	E 0	E 1	○		Brush Tap Swirl	<<<	<<<	<<<	<<<	Reverse Cymbal	Reverse Cymbal
29	F 0	F 1	○		Snare Roll	Snare Roll 2	<<<	<<<	<<<	<<<	<<<
30	F# 0	F# 1			Castanet	<<<	<<<	<<<	<<<	Hi Q 2	Hi Q 2
31	G 0	G 1			Snare Soft	Snare Soft 2	Snare Electro	<<<	Snare Noisy	Snare Snappy Electro	Snare Noisy 4
32	G# 0	G# 1			Sticks	<<<	<<<	<<<	<<<	<<<	<<<
33	A 0	A 1			Kick Soft	<<<	Kick Tight L	<<<	Kick Tight 2	Kick 3	Kick Tight 2
34	A# 0	A# 1			Open Rim Shot	Open Rim Shot H Short	Snare Pitched	<<<	<<<	<<<	<<<
35	B 0	B 1			Kick Tight	Kick Tight Short	Kick Wet	<<<	Kick 2	Kick Gate	Kick Analog Short
36	C 1	C 2			Kick	Kick Short	Kick Tight H	Kick Room	Kick Gate	Kick Gate Heavy	Kick Analog
37	C# 1	C# 2			Side Stick	<<<	Stick Ambient	<<<	<<<	<<<	Side Stick Analog
38	D 1	D 2			Snare	Snare Short	Snare Ambient	Snare Snappy	Snare Rock	Snare Noisy 2	Snare Analog
39	D# 1	D# 2			Hand Clap	<<<	<<<	<<<	<<<	<<<	<<<
40	E 1	E 2			Snare Tight	Snare Tight H	Snare Tight 2	Snare Tight Snappy	Snare Rock Rim	Snare Noisy 3	Snare Analog 2
41	F 1	F 2			Floor Tom L	<<<	Hybrid Tom 1	Tom Room 1	Tom Rock 1	Tom Electro 1	Tom Analog 1
42	F# 1	F# 2	1		Hi-Hat Closed	<<<	Hi-Hat Closed Light	<<<	<<<	<<<	Hi-Hat Closed Analog
43	G 1	G 2			Floor Tom H	<<<	Hybrid Tom 2	Tom Room 2	Tom Rock 2	Tom Electro 2	Tom Analog 2
44	G# 1	G# 2	1		Hi-Hat Pedal	<<<	Hi-Hat Pedal Light	<<<	<<<	<<<	Hi-Hat Closed Analog 2
45	A 1	A 2			Low Tom	<<<	Hybrid Tom 3	Tom Room 3	Tom Rock 3	Tom Electro 3	Tom Analog 3
46	A# 1	A# 2	1		Hi-Hat Open	<<<	Hi-Hat Open Light	<<<	<<<	<<<	Hi-Hat Open Analog
47	B 1	B 2			Mid Tom L	<<<	Hybrid Tom 4	Tom Room 4	Tom Rock 4	Tom Electro 4	Tom Analog 4
48	C 2	C 3			Mid Tom H	<<<	Hybrid Tom 5	Tom Room 5	Tom Rock 5	Tom Electro 5	Tom Analog 5
49	C# 2	C# 3			Crash Cymbal 1	<<<	<<<	<<<	<<<	<<<	Crash Analog
50	D 2	D 3			High Tom	<<<	Hybrid Tom 6	Tom Room 6	Tom Rock 6	Tom Electro 6	Tom Analog 6
51	D# 2	D# 3			Ride Cymbal 1	<<<	<<<	<<<	<<<	<<<	<<<
52	E 2	E 3			Chinese Cymbal	<<<	<<<	<<<	<<<	<<<	<<<
53	F 2	F 3			Ride Cymbal Cup	<<<	<<<	<<<	<<<	<<<	<<<
54	F# 2	F# 3			Tambourine	<<<	Tambourine Light	<<<	<<<	<<<	<<<
55	G 2	G 3			Splash Cymbal	<<<	<<<	<<<	<<<	<<<	<<<
56	G# 2	G# 3			Cowbell	<<<	<<<	<<<	<<<	<<<	Cowbell Analog
57	A 2	A 3			Crash Cymbal 2	<<<	<<<	<<<	<<<	<<<	<<<
58	A# 2	A# 3			Vibraslap	<<<	<<<	<<<	<<<	<<<	<<<
59	B 2	B 3			Ride Cymbal 2	<<<	<<<	<<<	<<<	<<<	<<<
60	C 3	C 4			Bongo H	<<<	<<<	<<<	<<<	<<<	<<<
61	C# 3	C# 4			Bongo L	<<<	<<<	<<<	<<<	<<<	<<<
62	D 3	D 4			Conga H Mute	<<<	<<<	<<<	<<<	<<<	Conga Analog H
63	D# 3	D# 4			Conga H Open	<<<	<<<	<<<	<<<	<<<	Conga Analog M
64	E 3	E 4			Conga L	<<<	<<<	<<<	<<<	<<<	Conga Analog L
65	F 3	F 4			Timbale H	<<<	<<<	<<<	<<<	<<<	<<<
66	F# 3	F# 4			Timbale L	<<<	<<<	<<<	<<<	<<<	<<<
67	G 3	G 4			Agogo H	<<<	<<<	<<<	<<<	<<<	<<<
68	G# 3	G# 4			Agogo L	<<<	<<<	<<<	<<<	<<<	<<<
69	A 3	A 4			Cabasa	<<<	<<<	<<<	<<<	<<<	<<<
70	A# 3	A# 4			Maracas	<<<	<<<	<<<	<<<	<<<	Maracas 2
71	B 3	B 4	○		Samba Whistle H	<<<	<<<	<<<	<<<	<<<	<<<
72	C 4	C 5	○		Samba Whistle L	<<<	<<<	<<<	<<<	<<<	<<<
73	C# 4	C# 5			Guiro Short	<<<	<<<	<<<	<<<	<<<	<<<
74	D 4	D 5	○		Guiro Long	<<<	<<<	<<<	<<<	<<<	<<<
75	D# 4	D# 5			Claves	<<<	<<<	<<<	<<<	<<<	Claves 2
76	E 4	E 5			Wood Block H	<<<	<<<	<<<	<<<	<<<	<<<
77	F 4	F 5			Wood Block L	<<<	<<<	<<<	<<<	<<<	<<<
78	F# 4	F# 5			Cuica Mute	<<<	<<<	<<<	<<<	Scratch H 2	Scratch H 2
79	G 4	G 5			Cuica Open	<<<	<<<	<<<	<<<	Scratch L 2	Scratch L 2
80	G# 4	G# 5		2	Triangle Mute	<<<	<<<	<<<	<<<	<<<	<<<
81	A 4	A 5		2	Triangle Open	<<<	<<<	<<<	<<<	<<<	<<<
82	A# 4	A# 5			Shaker	<<<	<<<	<<<	<<<	<<<	<<<
83	B 4	B 5			Jingle Bells	<<<	<<<	<<<	<<<	<<<	<<<
84	C 5	C 6			Bell Tree	<<<	<<<	<<<	<<<	<<<	<<<
85	C# 5	(C# 6)									
86	D 5	(D 6)									
87	D# 5	(D# 6)									
88	E 5	(E 6)									
89	F 5	(F 6)									
90	F# 5	(F# 6)									
91	G 5	(G 6)									

- Key Off: Keys marked "○" stop sounding the instant they are released.
- Alternate Group: Playing any instrument within a numbered group will immediately stop the sound of any other instrument in the same group of the same number.
- "<<<" indicates the content is the same as that of Standard Kit 1.
- " " indicates no sound.

Bank Select MSB					127	127	127	127	126	126
Bank Select LSB					0	0	0	0	0	0
Program Change# (0-127)					27	32	40	48	0	1
MIDI Note#	Note	Keyboard Note	Key Off	Alternate Group	Dance Kit	Jazz Kit	Brush Kit	Symphony Kit	SFX Kit 1	SFX Kit 2
13	C# -1	(C# 0)		3	<<<<	<<<<	<<<<	<<<<		
14	D -1	(D 0)		3	<<<<	<<<<	<<<<	<<<<		
15	D# -1	(D# 0)			<<<<	<<<<	<<<<	<<<<		
16	E -1	(E 0)			<<<<	<<<<	<<<<	<<<<		
17	F -1	(F 0)		4	<<<<	<<<<	<<<<	<<<<		
18	F# -1	(F# 0)		4	<<<<	<<<<	<<<<	<<<<		
19	G -1	(G 0)			<<<<	<<<<	<<<<	<<<<		
20	G# -1	(G# 0)			<<<<	<<<<	<<<<	<<<<		
21	A -1	(A 0)			<<<<	<<<<	<<<<	<<<<		
22	A# -1	(A# 0)			<<<<	<<<<	<<<<	<<<<		
23	B -1	(B 0)			<<<<	<<<<	<<<<	<<<<		
24	C 0	C 1			<<<<	<<<<	<<<<	<<<<		
25	C# 0	C# 1			<<<<	<<<<	<<<<	<<<<		
26	D 0	D 1	○		<<<<	<<<<	<<<<	<<<<		
27	D# 0	D# 1			<<<<	<<<<	<<<<	<<<<		
28	E 0	E 1	○		Reverse Cymbal	<<<<	<<<<	<<<<		
29	F 0	F 1	○		<<<<	<<<<	<<<<	<<<<		
30	F# 0	F# 1			Hi Q 2	<<<<	<<<<	<<<<		
31	G 0	G 1			Snare Techno 3	<<<<	Brush Slap 2	<<<<		
32	G# 0	G# 1			<<<<	<<<<	<<<<	<<<<		
33	A 0	A 1			Kick Techno Q	<<<<	<<<<	Kick Soft 2		
34	A# 0	A# 1			Rim Gate	<<<<	<<<<	<<<<		
35	B 0	B 1			Kick Techno L	<<<<	<<<<	Gran Cassa		
36	C 1	C 2			Kick Techno 2	Kick Jazz	Kick Small	Gran Cassa Mute	Cutting Noise	Telephone Dial
37	C# 1	C# 2			Side Stick Analog	<<<<	<<<<	<<<<	Cutting Noise 2	Door Squeak
38	D 1	D 2			Snare Clap	<<<<	Brush Slap 3	Band Snare		Door Slam
39	D# 1	D# 2			<<<<	<<<<	<<<<	<<<<	String Slap	Scratch
40	E 1	E 2			Snare Dry 2	<<<<	Brush Tap 2	Band Snare 2		Scratch H 2
41	F 1	F 2			Tom Analog 1	Tom Jazz 1	Tom Brush 1	Tom Jazz 1		Wind Chime
42	F# 1	F# 2		1	Hi-Hat Closed 3	<<<<	<<<<	<<<<		Telephone Ring 2
43	G 1	G 2			Tom Analog 2	Tom Jazz 2	Tom Brush 2	Tom Jazz 2		
44	G# 1	G# 2		1	Hi-Hat Closed Analog 2	<<<<	<<<<	<<<<		
45	A 1	A 2			Tom Analog 3	Tom Jazz 3	Tom Brush 3	Tom Jazz 3		
46	A# 1	A# 2		1	Hi-Hat Open 3	<<<<	<<<<	<<<<		
47	B 1	B 2			Tom Analog 4	Tom Jazz 4	Tom Brush 4	Tom Jazz 4		
48	C 2	C 3			Tom Analog 5	Tom Jazz 5	Tom Brush 5	Tom Jazz 5		
49	C# 2	C# 3			Crash Analog	<<<<	<<<<	Hand Cymbal		
50	D 2	D 3			Tom Analog 6	Tom Jazz 6	Tom Brush 6	Tom Jazz 6		
51	D# 2	D# 3			<<<<	<<<<	<<<<	Hand Cymbal Short		
52	E 2	E 3			<<<<	<<<<	<<<<	<<<<	Flute Key Click	Car Engine Ignition
53	F 2	F 3			<<<<	<<<<	<<<<	<<<<		Car Tires Squeal
54	F# 2	F# 3			<<<<	<<<<	<<<<	<<<<		Car Passing
55	G 2	G 3			<<<<	<<<<	<<<<	<<<<		Car Crash
56	G# 2	G# 3			Cowbell Analog	<<<<	<<<<	<<<<		Siren
57	A 2	A 3			<<<<	<<<<	<<<<	Hand Cymbal 2		Train
58	A# 2	A# 3			<<<<	<<<<	<<<<	<<<<		Jet Plane
59	B 2	B 3			<<<<	<<<<	<<<<	Hand Cymbal 2 Short		Starship
60	C 3	C 4			<<<<	<<<<	<<<<	<<<<		Burst
61	C# 3	C# 4			<<<<	<<<<	<<<<	<<<<		Roller Coaster
62	D 3	D 4			Conga Analog H	<<<<	<<<<	<<<<		Submarine
63	D# 3	D# 4			Conga Analog M	<<<<	<<<<	<<<<		
64	E 3	E 4			Conga Analog L	<<<<	<<<<	<<<<		
65	F 3	F 4			<<<<	<<<<	<<<<	<<<<		
66	F# 3	F# 4			<<<<	<<<<	<<<<	<<<<		
67	G 3	G 4			<<<<	<<<<	<<<<	<<<<		
68	G# 3	G# 4			<<<<	<<<<	<<<<	<<<<	Shower	Laughing
69	A 3	A 4			<<<<	<<<<	<<<<	<<<<	Thunder	Scream
70	A# 3	A# 4			Maracas 2	<<<<	<<<<	<<<<	Wind	Punch
71	B 3	B 4	○		<<<<	<<<<	<<<<	<<<<	Stream	Heart Beat
72	C 4	C 5	○		<<<<	<<<<	<<<<	<<<<	Bubble	Foot Steps
73	C# 4	C# 5			<<<<	<<<<	<<<<	<<<<	Feed	
74	D 4	D 5	○		<<<<	<<<<	<<<<	<<<<		
75	D# 4	D# 5			Claves 2	<<<<	<<<<	<<<<		
76	E 4	E 5			<<<<	<<<<	<<<<	<<<<		
77	F 4	F 5			<<<<	<<<<	<<<<	<<<<		
78	F# 4	F# 5			Scratch H 2	<<<<	<<<<	<<<<		
79	G 4	G 5			Scratch L 2	<<<<	<<<<	<<<<		
80	G# 4	G# 5		2	<<<<	<<<<	<<<<	<<<<		
81	A 4	A 5		2	<<<<	<<<<	<<<<	<<<<		
82	A# 4	A# 5			<<<<	<<<<	<<<<	<<<<		
83	B 4	B 5			<<<<	<<<<	<<<<	<<<<		
84	C 5	C 6			<<<<	<<<<	<<<<	<<<<	Dog	Machine Gun
85	C# 5	(C# 6)							Horse	Laser Gun
86	D 5	(D 6)							Bird Tweet 2	Explosion
87	D# 5	(D# 6)								Firework
88	E 5	(E 6)								
89	F 5	(F 6)								
90	F# 5	(F# 6)							Ghost	
91	G 5	(G 6)							Maou	

# Style List

Category	Preset 1 Order	Preset 2 Order	Name
8 BEAT 1	1	6	8 Beat 1
	2	7	8 Beat 2
	3	8	8 Beat 3
	4	9	8 Beat 4
	5	10	8 Beat Adria
	6	5	Heart Beat
	7	4	Organ Ballad
	8	3	Piano Ballad
	9	1	Pop Rock 1
	10	2	Pop Rock 2
8 BEAT 2	1	2	8 Beat Soft
	2	3	8 Beat Heat
	3	4	8 Beat Soul
	4	5	Guitar Ballad
	5	1	8 Beat Pop
	6	8	Polka Pop 1
	7	9	Polka Pop 2
	8	10	Polka Pop 3
	9	6	Baroque
	10	7	Pop Rhumba
16 BEAT	1	1	16 Beat 1
	2	2	16 Beat 2
	3	6	Pop Ballad 1
	4	7	Pop Ballad 2
	5	15	Funky Pop
	6	5	Hip Hop Pop
	7	18	Soul Shuffle
	8	16	Street Pop
	9	14	Soft Fusion
	10	17	West End
	11	3	16 Beat 3
	12	4	16 Beat 4
	13	8	Pop Ballad 3
	14	9	Pop Ballad 4
	15	13	Funky Fusion
	16	10	Analog Pop
	17	20	Game Show
	18	19	Cool Night
	19	11	Fusion 1
	20	12	Fusion 2

Category	Preset 1 Order	Preset 2 Order	Name
BALLAD	1	10	Love Song
	2	9	Slow Ballad
	3	6	16Beat Ballad 1
	4	7	16Beat Ballad 2
	5	8	Epic Ballad
	6	1	Slow Rock 1
	7	2	Slow Rock 2
	8	3	Slow Rock 3
	9	4	6/8 Ballad
	10	5	Modern 6/8
ROCK	1	1	Rock 1
	2	2	Rock 2
	3	6	Hard Rock
	4	8	Rock Shffle 1
	5	9	Rock Shffle 2
	6	7	6/8 Rock
	7	15	Jazz Rock
	8	14	Soft Rock
	9	11	Rock Ballad 1
	10	17	Cowboy Rock
	11	3	Rock 3
	12	4	Rock 4
	13	5	Sunny Rock
	14	12	Rock Ballad 2
	15	13	Rock Ballad 3
	16	16	80's Rock
	17	10	LA Shuffle
	18	18	Rock Classic

Category	Preset 1 Order	Preset 2 Order	Name
DANCE FLOOR	1	1	Eurobeat
	2	11	Entrance
	3	2	Euro House
	4	3	Techno 1
	5	6	Trance 1
	6	8	Rave
	7	9	Clubdance 1
	8	16	Dance Pop 1
	9	13	Dance Soul
	10	14	Hip Hop
	11	15	Trip Hop
	12	4	Techno 2
	13	5	Techno 3
	14	17	Dance Pop 2
	15	18	Dance Pop 3
	16	10	Clubdance 2
	17	7	Trance 2
	18	19	Cool Dance
	19	20	Funky Dance
	20	12	Groundbeat
DISCO	1	1	70's Disco 1
	2	12	Disco Girls
	3	10	Disco Samba
	4	19	Meneito
	5	9	Disco Latin
	6	13	Disco Hands
	7	6	Disco Queen
	8	15	Disco Fox
	9	11	Disco Rock
	10	14	Disco Pop
	11	2	70's Disco 2
	12	3	70's Disco 3
	13	16	Party Pop
	14	8	Disco Tropic
	15	18	Soul Dance
	16	17	Electro Pop
	17	5	Disco Philly
	18	4	Disco Clap
	19	7	Disco Slap
	20	20	Synth Boogie



Category	Preset 1 Order	Preset 2 Order	Name
SWING & JAZZ	1	1	Swing 1
	2	3	Big Band Swing 1
	3	4	Big Band Swing 2
	4	7	Swing Ballad
	5	8	Swing Waltz 1
	6	16	Dixieland 1
	7	15	Ragtime
	8	6	Gypsy Swing
	9	13	Jazz Quartet
	10	18	Lazy Jive
	11	2	Swing 2
	12	5	Big Band Swing 3
	13	12	Cool Jazz
	14	14	Bebop
	15	10	Jazz Waltz
	16	17	Dixieland 2
	17	9	Swing Waltz 2
	18	11	Big Band Jazz
R & B	1	1	4/4 Blues
	2	2	6/8 Blues 1
	3	5	Blues Rock
	4	4	Blues Ballad
	5	7	Rock & Roll
	6	11	Twist 1
	7	8	Boogie 1
	8	10	Big Band Boogie
	9	15	Funk
	10	13	R & B
	11	14	Soul
	12	3	6/8 Blues 2
	13	6	Blues Shuffle
	14	16	Pop Shuffle 1
	15	17	Pop Shuffle 2
	16	12	Twist 2
	17	9	Boogie 2

Category	Preset 1 Order	Preset 2 Order	Name
COUNTRY	1	1	Country Rock 1
	2	2	Country Rock 2
	3	3	Country Rock 3
	4	6	Country Shuffle 1
	5	8	Country Swing 1
	6	14	Bluegrass 1
	7	11	Country 2/4
	8	13	Folk Rock
	9	5	Country Ballad
	10	10	Country Waltz
	11	4	Country Rock 4
	12	12	Two Step
	13	16	Cowboy Boogie
	14	7	Country Shuffle 2
	15	9	Country Swing 2
	16	15	Bluegrass 2
	17	17	Light Pop
LATIN	1	6	Samba Rio
	2	1	Bossa Nova 1
	3	3	More Bossa
	4	11	Reggae 1
	5	12	Reggae 2
	6	13	Pop Reggae
	7	14	Swing Reggae
	8	19	Espagnole
	9	8	Lambada
	10	16	Mambo 1
	11	7	Jazz Samba
	12	4	Pop Bossa 1
	13	5	Pop Bossa 2
14	2	Bossa Nova 2	
15	15	Pop Cha Cha	
16	18	Salsa	
17	10	Merengue	
18	9	Tejano	
19	20	Spanish Pasodoble	
20	17	Mambo 2	

Category	Preset 1 Order	Preset 2 Order	Name
BALLROOM	1	13	Vienna Waltz
	2	11	English Waltz 1
	3	14	Slowfox
	4	16	Foxtrot 1
	5	9	Tango
	6	6	Samba
	7	1	Rhumba 1
	8	4	Cha Cha Cha
	9	5	Pasodoble
	10	7	Jive
	11	15	Quickstep
	12	12	English Waltz 2
	13	17	Foxtrot 2
	14	18	Foxtrot 3
	15	19	Foxtrot 4
	16	8	Shuffle
	17	20	Big Band Quickstep
	18	3	Beguine
	19	2	Rhumba 2
	20	10	Tango Argentina
MARCH & WALTZ	1	1	March 1
	2	3	6/8 March
	3	13	Tarantella
	4	4	Musette
	5	5	Pop Waltz
	6	10	Polka Oberkrainer
	7	11	Polka 1
	8	9	Waltz Oberkrainer
	9	6	Traditional Waltz 1
	10	7	Traditional Waltz 2
	11	2	March 2
	12	12	Polka 2
	13	14	Overture
	14	8	Big Band Waltz

# Direct Access Chart

Operation ([DIRECT ACCESS] + button or controller listed below)	Accessed Display	Comments	Page
[DEMO/HELP]	HELP		20
[SONG SELECT]	SONG SELECT - SONG ORDER		103
[SONG]	MIXING CONSOLE FADER - PART SWITCH	* Only when SONG indicator ON	104
[AUTO ACCOMPANIMENT]	FUNCTION2 : SPLIT POINT/FINGERING		123
[STYLE] Buttons	FUNCTION6 : CUSTOMIZE LIST (STYLE)	* Displays a list of the selected category.	129
[GROOVE STYLE]	GROOVE STYLE CREATOR - SET UP	* Edits the selected style.	78
[CUSTOM STYLE]	CUSTOM STYLE CREATOR - BASIC	* Edits the selected style.	66
[INTRO A/B]	MIXING CONSOLE FADER - ACCOMP PART SWITCH		36
[MAIN/AUTO FILL A]	MIXING CONSOLE FADER - ACCOMP PART SWITCH		36
[MAIN/AUTO FILL B]	MIXING CONSOLE FADER - ACCOMP PART SWITCH		36
[ENDING A/B/rit.]	MIXING CONSOLE FADER - ACCOMP PART SWITCH		36
VOICE EFFECT [REVERB (1)]	MIXING CONSOLE FULL [MAIN PART] - EFFECT DEPTH (REVERB)		41
VOICE EFFECT [CHORUS (2)]	MIXING CONSOLE FULL [MAIN PART] - EFFECT DEPTH (CHORUS)		41
VOICE EFFECT [HARMONY/ECHO]	FUNCTION5 : HARMONY/ECHO		129
VOICE EFFECT [DSP (4-6)]	MIXING CONSOLE FULL - EFFECT TYPE		42
VOICE EFFECT [DSP VARIATION]	MIXING CONSOLE FULL - EFFECT TYPE - PARAMETER EDIT		42
[VOICE] Buttons	FUNCTION6 : CUSTOMIZE LIST (VOICE)	* Displays a list of the selected category.	129
[ORGAN FLUTE]	ORGAN FLUTE main display		48
[XG]	FUNCTION9 : MIDI - TEMPLATE		132
[LEFT] (Both PART SELECT and PART ON/OFF buttons)	MIXING CONSOLE FADER - MAIN PART SWITCH		22
[RIGHT1](Both PART SELECT and PART ON/OFF buttons)	MIXING CONSOLE FADER - MAIN PART SWITCH		22
[RIGHT2](Both PART SELECT and PART ON/OFF buttons)	MIXING CONSOLE FADER - MAIN PART SWITCH		22
[LEAD](Both PART SELECT and PART ON/OFF buttons)	MIXING CONSOLE FADER - MAIN PART SWITCH		22
VOCAL/SAMPLING [REVERB (1)]	MIXING CONSOLE FULL [MAIN PART] - EFFECT DEPTH (REVERB)		41
VOCAL/SAMPLING [CHORUS (2)]	MIXING CONSOLE FULL [MAIN PART] - EFFECT DEPTH (CHORUS)		41
VOCAL/SAMPLING [DSP (7)]	MIXING CONSOLE FULL [MAIN PART] - EFFECT DEPTH (DSP)		42
VOCAL/SAMPLING [VOCAL HARMONY (8)]	MIXING CONSOLE FULL - EFFECT TYPE	* Displays the VOCAL HARMONY item.	42
VOCAL/SAMPLING [HARMONY VARIATION]	MIXING CONSOLE FULL - EFFECT TYPE - PARAMETER EDIT	* Displays the VOCAL HARMONY item.	42
VOCAL/SAMPLING [TALK]	FUNCTION7 : TALK SETTING		130
[REGIST BANK 1-16] Buttons	FUNCTION4 : REGISTRATION (OVERVIEW)		127
[REGISTRATION MEMORY 1-8] Buttons	FUNCTION4 : REGISTRATION (NAME)		127
[FREEZE]	FUNCTION4 : REGISTRATION (FREEZE GROUP SETTING)		127
[ONE TOUCH SETTING 1-4] Buttons	FUNCTION4 : ONE TOUCH SETTING (CUSTOM OTS)		127
[FOOT PEDAL SWITCH1]	FUNCTION3 : CONTROLLER - FOOT CONTROLLER (SW1)		124
[FOOT PEDAL SWITCH2]	FUNCTION3 : CONTROLLER - FOOT CONTROLLER (SW2)		124
[FOOT PEDAL VOLUME]	FUNCTION3 : CONTROLLER - FOOT CONTROLLER (VOLUME)		124
[PITCH BEND]	MIXING CONSOLE FULL - TUNING (PITCH BEND RANGE)		44
[MODULATION]	FUNCTION3 : CONTROLLER - PANEL CONTROLLER (MODULATION WHEEL)		126

# Parameter Chart

• About the symbols

O: Memorized.

-: Not memorized.

On: Always on when One Touch Setting recalled.

FADER: Refer to the MIXING CONSOLE (FADER) section.

PANEL: Refer to the Panel Controls section.

\* 1: Included in LOAD FROM DISK and SAVE TO DISK SETUP.

\* 2: Backs up data created by the user.

	Registration	One Touch Setting	Freeze Group	Parameter Lock	Setup (Disk) *1	Backup	Voice Set Group
<b>Panel controls</b>							
Style #	O	-	Acmp.	-	O	O	-
Style # in Category	O	-	Acmp.	-	O	O	-
Style Category #	O	-	Acmp.	-	O	O	-
Auto Accompaniment	O	O	Acmp.	-	O	O	-
Virtual Arranger	O	-	Acmp.	-	O	O	-
Sync Stop	-	-	-	-	-	-	-
Sync Start	-	On	-	-	-	-	-
Start/Stop	-	-	-	-	-	-	-
Intro A/B	-	-	-	-	-	-	-
MainA/AutoFill	O	O	Acmp.	-	O	O	-
MainB/AutoFill	O	O	Acmp.	-	O	O	-
EndingA/B/rit.	-	-	-	-	-	-	-
Fade In/Out	-	-	-	-	-	-	-
Multi Pad Bank	O	O	Multi Pad	-	O	O	-
Multi Pad Stop	-	-	-	-	-	-	-
Multi Pad 1/2/3/4	-	-	-	-	-	-	-
Tempo	O	-	Tempo	-	O	O	-
Left Voice #	O	O	Acmp.	-	O	O	-
Right1 Voice #	O	O	Voice	-	O	O	-
Right2 Voice #	O	O	Voice	-	O	O	-
Lead Voice #	O	O	Voice	-	O	O	-
Left Voice # in Category	-	-	-	-	-	O	-
Right1 Voice # in Category	-	-	-	-	-	O	-
Right2 Voice # in Category	-	-	-	-	-	O	-
Lead Voice # in Category	-	-	-	-	-	O	-
Left Voice Category #	O	O	-	-	O	O	-
Right1 Voice Category #	O	O	-	-	O	O	-
Right2 Voice Category #	O	O	-	-	O	O	-
Lead Voice Category #	O	O	-	-	O	O	-
Left Voice Custom #	O	O	-	-	O	O	-
Right1 Voice Custom #	O	O	-	-	O	O	-
Right2 Voice Custom #	O	O	-	-	O	O	-
Lead Voice Custom #	O	O	-	-	O	O	-
Part Select (Left/Right1/Right2/Lead)	-	-	-	-	-	O	-
Left Part On/Off	O	O	Acmp.	-	O	O	-
Right1 Part On/Off	O	O	Voice	-	O	O	-
Right2 Part On/Off	O	O	Voice	-	O	O	-
Lead Part On/Off	O	O	Voice	-	O	O	-
Left Hold	O	O	Acmp.	-	O	O	-
Left Reverb On/Off	O	O	Acmp.	-	O	O	VOICE
Right1 Reverb On/Off	O	O	Effects	-	O	O	VOICE
Right2 Reverb On/Off	O	O	Effects	-	O	O	VOICE
Lead Reverb On/Off	O	O	Effects	-	O	O	VOICE
Left Chorus On/Off	O	O	Acmp.	-	O	O	VOICE
Right1 Chorus On/Off	O	O	Effects	-	O	O	VOICE
Right2 Chorus On/Off	O	O	Effects	-	O	O	VOICE
Lead Chorus On/Off	O	O	Effects	-	O	O	VOICE

	Registration	One Touch Setting	Freeze Group	Parameter Lock	Setup (Disk) *1	Backup	Voice Set Group
Harmony/Echo On/Off	O	O	Harmony	-	O	O	-
Right1 DSP(DSP5) On/Off	O	O	Effects	-	O	O	DSP
Right2 DSP(DSP6) On/Off	O	O	Effects	-	O	O	DSP
Lead DSP(DSP4) On/Off	O	O	Effects	-	O	O	DSP
Right1 DSP Variation On/Off	O	O	Effects	-	O	O	DSP
Right2 DSP Variation On/Off	O	O	Effects	-	O	O	DSP
Lead DSP Variation On/Off	O	O	Effects	-	O	O	DSP
Left Poly/Mono On/Off	O	O	Acmp.	-	O	O	VOICE
Right1 Poly/Mono On/Off	O	O	Voice	-	O	O	VOICE
Right2 Poly/Mono On/Off	O	O	Voice	-	O	O	VOICE
Lead Poly/Mono On/Off	O	O	Voice	-	O	O	VOICE
Vocal/Sampling Reverb On/Off	O	-	Mic	-	O	O	-
Vocal/Sampling Chorus On/Off	O	-	Mic	-	O	O	-
Vocal/Sampling DSP On/Off	O	-	Mic	-	O	O	-
Vocal/Sampling Vocal Harmony On/Off	O	-	Mic	-	O	O	-
Vocal/Sampling Harmony Variation On/Off	O	-	Mic	-	O	O	-
Vocal/Sampling Talk On/Off	O	-	Mic	-	O	-	-
Master Transpose	O	-	Tune Trans	-	O	O	-
Left Octave	O	O	Acmp.	-	O	O	-
Right1 Octave	O	O	Voice	-	O	O	-
Right2 Octave	O	O	Voice	-	O	O	-
Lead Octave	O	O	Voice	-	O	O	-
Pitch Bend	-	-	-	-	-	-	-
Modulation	-	-	-	-	-	-	-
Demo/Help	-	-	-	-	-	-	-
Song	O	-	Song	-	-	-	-
Song Select(Song#)	O	-	Song	-	-	-	-
Song Select(Directry#)	O	-	Song	-	-	-	-
Song Name	O	-	Song	-	-	-	-
Song Chord Detection	-	-	-	-	-	O	-
Song Vocal Harmony Track	-	-	-	-	-	O	-
Song Pause/Rew/FF	-	-	-	-	-	-	-
Custom Voice Creator	-	-	-	-	-	* 2	-
Custom Style Creator	-	-	-	-	-	* 2	-
Function	-	-	-	-	-	-	-
Song/Multi Pad Recording	-	-	-	-	-	O	-
Sampling	-	-	-	-	-	-	-
Disk	-	-	-	-	-	-	-
Direct Access	-	-	-	-	-	-	-
Mixing Console Fader/Full	-	-	-	-	-	-	-
Exit	-	-	-	-	-	-	-
Registration Memory bank	-	-	-	-	-	-	-
Registration Memory 1~8	-	-	-	-	-	-	-
Registration Memory Memory	-	-	-	-	-	* 2	-
Freeze	-	-	-	-	-	O	-
One Touch Setting (Custom OTS)	-	-	-	-	-	O	* 2
Custom OTS Style Num	-	-	-	-	-	O	O

# Parameter Chart

	Registration	One Touch Setting	Freeze Group	Parameter Lock	Setup (Disk) #1	Backup	Voice Set Group
<b>VOICE</b>							
OrganFlute Reverb On/Off	<input type="radio"/>	<input type="radio"/>	Voice	Organ Flute	<input type="radio"/>	<input type="radio"/>	-
OrganFlute Reverb Depth	<input type="radio"/>	<input type="radio"/>	Voice	Organ Flute	<input type="radio"/>	<input type="radio"/>	-
OrganFlute Chorus On/Off	<input type="radio"/>	<input type="radio"/>	Voice	Organ Flute	<input type="radio"/>	<input type="radio"/>	-
OrganFlute Chorus Depth	<input type="radio"/>	<input type="radio"/>	Voice	Organ Flute	<input type="radio"/>	<input type="radio"/>	-
OrganFlute DSP On/Off	<input type="radio"/>	<input type="radio"/>	Voice	Organ Flute	<input type="radio"/>	<input type="radio"/>	-
OrganFlute DSP Depth	<input type="radio"/>	<input type="radio"/>	Voice	Organ Flute	<input type="radio"/>	<input type="radio"/>	-
OrganFlute Vibrato Speed	<input type="radio"/>	<input type="radio"/>	Voice	Organ Flute	<input type="radio"/>	<input type="radio"/>	-
OrganFlute DSP Type	<input type="radio"/>	<input type="radio"/>	Voice	Organ Flute	<input type="radio"/>	<input type="radio"/>	-
OrganFlute DSP Variation On/Off	<input type="radio"/>	<input type="radio"/>	Voice	Organ Flute	<input type="radio"/>	<input type="radio"/>	-
OrganFlute DSP Parameter Num	-	-	-	-	<input type="radio"/>	<input type="radio"/>	-
OrganFlute DSP Parameter Value	<input type="radio"/>	<input type="radio"/>	Voice	Organ Flute	<input type="radio"/>	<input type="radio"/>	-
OrganFlute EQ Low Freq.	<input type="radio"/>	<input type="radio"/>	Voice	Organ Flute	<input type="radio"/>	<input type="radio"/>	-
OrganFlute EQ Low Gain	<input type="radio"/>	<input type="radio"/>	Voice	Organ Flute	<input type="radio"/>	<input type="radio"/>	-
OrganFlute EQ High Freq.	<input type="radio"/>	<input type="radio"/>	Voice	Organ Flute	<input type="radio"/>	<input type="radio"/>	-
OrganFlute EQ High Gain	<input type="radio"/>	<input type="radio"/>	Voice	Organ Flute	<input type="radio"/>	<input type="radio"/>	-
OrganFlute Organ Type	<input type="radio"/>	<input type="radio"/>	Voice	Organ Flute	<input type="radio"/>	<input type="radio"/>	-
OrganFlute Rotary Speaker Speed	<input type="radio"/>	<input type="radio"/>	Effects	-	<input type="radio"/>	<input type="radio"/>	-
OrganFlute Vibrato On/Off	<input type="radio"/>	<input type="radio"/>	Voice	Organ Flute	<input type="radio"/>	<input type="radio"/>	-
OrganFlute Vibrato Depth	<input type="radio"/>	<input type="radio"/>	Voice	Organ Flute	<input type="radio"/>	<input type="radio"/>	-
OrganFlute Footage 16'	<input type="radio"/>	<input type="radio"/>	Voice	Organ Flute	<input type="radio"/>	<input type="radio"/>	-
OrganFlute Footage 8'	<input type="radio"/>	<input type="radio"/>	Voice	Organ Flute	<input type="radio"/>	<input type="radio"/>	-
OrganFlute Footage 51/3'	<input type="radio"/>	<input type="radio"/>	Voice	Organ Flute	<input type="radio"/>	<input type="radio"/>	-
OrganFlute Footage 4'	<input type="radio"/>	<input type="radio"/>	Voice	Organ Flute	<input type="radio"/>	<input type="radio"/>	-
OrganFlute Footage 22/3'	<input type="radio"/>	<input type="radio"/>	Voice	Organ Flute	<input type="radio"/>	<input type="radio"/>	-
OrganFlute Footage 2'	<input type="radio"/>	<input type="radio"/>	Voice	Organ Flute	<input type="radio"/>	<input type="radio"/>	-
OrganFlute Footage 11/3'	<input type="radio"/>	<input type="radio"/>	Voice	Organ Flute	<input type="radio"/>	<input type="radio"/>	-
OrganFlute Footage 1'	<input type="radio"/>	<input type="radio"/>	Voice	Organ Flute	<input type="radio"/>	<input type="radio"/>	-
OrganFlute Volume	<input type="radio"/>	<input type="radio"/>	Voice	Organ Flute	<input type="radio"/>	<input type="radio"/>	-
OrganFlute Attack Mode	<input type="radio"/>	<input type="radio"/>	Voice	Organ Flute	<input type="radio"/>	<input type="radio"/>	-
OrganFlute Attack 4'	<input type="radio"/>	<input type="radio"/>	Voice	Organ Flute	<input type="radio"/>	<input type="radio"/>	-
OrganFlute Attack 22/3'	<input type="radio"/>	<input type="radio"/>	Voice	Organ Flute	<input type="radio"/>	<input type="radio"/>	-
OrganFlute Attack 2'	<input type="radio"/>	<input type="radio"/>	Voice	Organ Flute	<input type="radio"/>	<input type="radio"/>	-
OrganFlute Attack Length	<input type="radio"/>	<input type="radio"/>	Voice	Organ Flute	<input type="radio"/>	<input type="radio"/>	-
OrganFlute Attack Response	<input type="radio"/>	<input type="radio"/>	Voice	Organ Flute	<input type="radio"/>	<input type="radio"/>	-
<b>FUNCTION</b>							
<b>F1</b>							
Master Tune	-	-	-	-	<input type="radio"/>	<input type="radio"/>	-
Scale Arabic/Equal Temp.	<input type="radio"/>	-	Scale	-	<input type="radio"/>	-	-
Tune (C)	<input type="radio"/>	-	Scale	-	<input type="radio"/>	-	-
Tune (Db)	<input type="radio"/>	-	Scale	-	<input type="radio"/>	-	-
Tune (D)	<input type="radio"/>	-	Scale	-	<input type="radio"/>	-	-
Tune (Eb)	<input type="radio"/>	-	Scale	-	<input type="radio"/>	-	-
Tune (E)	<input type="radio"/>	-	Scale	-	<input type="radio"/>	-	-
Tune (F)	<input type="radio"/>	-	Scale	-	<input type="radio"/>	-	-
Tune (F#)	<input type="radio"/>	-	Scale	-	<input type="radio"/>	-	-
Tune (G)	<input type="radio"/>	-	Scale	-	<input type="radio"/>	-	-
Tune (Ab)	<input type="radio"/>	-	Scale	-	<input type="radio"/>	-	-
Tune (A)	<input type="radio"/>	-	Scale	-	<input type="radio"/>	-	-
Tune (Bb)	<input type="radio"/>	-	Scale	-	<input type="radio"/>	-	-
Tune (B)	<input type="radio"/>	-	Scale	-	<input type="radio"/>	-	-

	Registration	One Touch Setting	Freeze Group	Parameter Lock	Setup (Disk) #1	Backup	Voice Set Group
<b>F2</b>							
ABC SplitPoint	<input type="radio"/>	<input type="radio"/>	Acmp.	Acmp. Split Point	<input type="radio"/>	<input type="radio"/>	-
Left SplitPoint	<input type="radio"/>	<input type="radio"/>	Acmp.	Left Split Point	<input type="radio"/>	<input type="radio"/>	-
Fingering	<input type="radio"/>	<input type="radio"/>	Acmp.	-	<input type="radio"/>	<input type="radio"/>	-
<b>F3</b>							
Foot Volume Master/Individual	<input type="radio"/>	-	Controller	-	<input type="radio"/>	<input type="radio"/>	-
Foot Volume Assign	<input type="radio"/>	-	Controller	-	<input type="radio"/>	<input type="radio"/>	-
Foot Sw1 Type	<input type="radio"/>	-	Controller	-	<input type="radio"/>	<input type="radio"/>	-
Foot Sw1 Assign	<input type="radio"/>	-	Controller	-	<input type="radio"/>	<input type="radio"/>	-
Foot Sw1 Percussion Kit #	<input type="radio"/>	-	Controller	-	<input type="radio"/>	<input type="radio"/>	-
Foot Sw1 Percussion Note #	<input type="radio"/>	-	Controller	-	<input type="radio"/>	<input type="radio"/>	-
Foot Sw1 Percussion Velocity	<input type="radio"/>	-	Controller	-	<input type="radio"/>	<input type="radio"/>	-
Foot Sw2 Type	<input type="radio"/>	-	Controller	-	<input type="radio"/>	<input type="radio"/>	-
Foot Sw2 Assign	<input type="radio"/>	-	Controller	-	<input type="radio"/>	<input type="radio"/>	-
Foot Sw2 Percussion Kit #	<input type="radio"/>	-	Controller	-	<input type="radio"/>	<input type="radio"/>	-
Foot Sw2 Percussion Note #	<input type="radio"/>	-	Controller	-	<input type="radio"/>	<input type="radio"/>	-
Foot Sw2 Percussion Velocity	<input type="radio"/>	-	Controller	-	<input type="radio"/>	<input type="radio"/>	-
Modulation Wheel Assign	<input type="radio"/>	<input type="radio"/>	Controller	-	<input type="radio"/>	<input type="radio"/>	-
Initial Touch Sensitivity	<input type="radio"/>	-	Controller	-	<input type="radio"/>	<input type="radio"/>	-
Initial Touch Assign	<input type="radio"/>	-	Controller	-	<input type="radio"/>	<input type="radio"/>	-
Initial Touch Off Level	<input type="radio"/>	-	Controller	-	<input type="radio"/>	-	-
After Touch Sensitivity	<input type="radio"/>	-	Controller	-	<input type="radio"/>	<input type="radio"/>	-
After Touch Assign	<input type="radio"/>	<input type="radio"/>	Controller	-	<input type="radio"/>	<input type="radio"/>	-
<b>F4</b>							
Freeze Group Setting	-	-	-	-	<input type="radio"/>	<input type="radio"/>	-
Voice Set Assign Left	-	-	-	-	<input type="radio"/>	<input type="radio"/>	-
Voice Set Assign Right1	-	-	-	-	<input type="radio"/>	<input type="radio"/>	-
Voice Set Assign Right2	-	-	-	-	<input type="radio"/>	<input type="radio"/>	-
Voice Set Assign Lead	-	-	-	-	<input type="radio"/>	<input type="radio"/>	-
<b>F5</b>							
Harmony/Echo Type	<input type="radio"/>	<input type="radio"/>	Harmony	-	<input type="radio"/>	<input type="radio"/>	HRM
Harmony/Echo Volume	<input type="radio"/>	<input type="radio"/>	Harmony	-	<input type="radio"/>	<input type="radio"/>	HRM
Harmony/Echo Speed	<input type="radio"/>	<input type="radio"/>	Harmony	-	<input type="radio"/>	<input type="radio"/>	HRM
Harmony/Echo Assign	<input type="radio"/>	<input type="radio"/>	Harmony	-	<input type="radio"/>	<input type="radio"/>	HRM
<b>F6</b>							
Voice Customize List Type	-	-	-	-	<input type="radio"/>	<input type="radio"/>	-
Voice Customize List Data	-	-	-	-	<input type="radio"/>	<input type="radio"/>	-
Style Customize list Type	-	-	-	-	<input type="radio"/>	<input type="radio"/>	-
Style Customize list Data	-	-	-	-	<input type="radio"/>	<input type="radio"/>	-
<b>F7</b>							
Talk Volume	-	-	-	-	<input type="radio"/>	<input type="radio"/>	-
Talk Panpot	-	-	-	-	<input type="radio"/>	<input type="radio"/>	-
Talk Reverb Depth	-	-	-	-	<input type="radio"/>	<input type="radio"/>	-
Talk Chorus Depth	-	-	-	-	<input type="radio"/>	<input type="radio"/>	-
Talk Total Volume Attenuatop	-	-	-	-	<input type="radio"/>	<input type="radio"/>	-
Talk DSP On/Off	-	-	-	-	<input type="radio"/>	<input type="radio"/>	-
Talk DSP Depth	-	-	-	-	<input type="radio"/>	<input type="radio"/>	-
Talk DSP Type	-	-	-	-	<input type="radio"/>	<input type="radio"/>	-
Talk Vocal Harmony On/Off	-	-	-	-	<input type="radio"/>	<input type="radio"/>	-
Talk Vocal Harmony Type	-	-	-	-	<input type="radio"/>	<input type="radio"/>	-

	Registration	One Touch Setting	Freeze Group	Parameter Lock	Setup (Disk) #1	Backup	Voice Set Group
<b>F8</b>							
Auto Load	-	-	-	-	-	○	-
Memory Backup	-	-	-	-	-	○	-
Display MIDI Bank Select & ProgramChange #	-	-	-	-	○	○	-
Display Message TimeOut	-	-	-	-	○	○	-
Metronome Volume	-	-	-	-	○	○	-
Parameter Lock	-	-	-	-	○	○	-
<b>F9</b>							
MIDI Local Control	-	-	-	-	○	○	-
MIDI Clock Internal/External	-	-	-	-	○	○	-
MIDI Transmit Clock	-	-	-	-	○	○	-
MIDI Receive transpose	-	-	-	-	○	○	-
MIDI Sys./Ex. Transmit	-	-	-	-	○	○	-
MIDI Sys./Ex. Receive	-	-	-	-	○	○	-
MIDI Chord Sys./Ex. Transmit	-	-	-	-	○	○	-
MIDI Chord Sys./Ex. Receive	-	-	-	-	○	○	-
MIDI Transmit Ch Part	-	-	-	-	○	○	-
MIDI Transmit Ch Switch	-	-	-	-	○	○	-
MIDI Receive Ch Part	-	-	-	-	○	○	-
MIDI Receive Ch Switch	-	-	-	-	○	○	-
MIDI Panel Control	-	-	-	-	○	○	-
TX User1/User2/User3	-	-	-	-	○	○	-
RD User1/User2/User3	-	-	-	-	○	○	-
<b>MIXING CONSOLE (FADER)</b>							
MainVolume Song	○	-	Song	-	○	○	-
MainVolume Acmp.	○	-	Acmp.	-	○	○	-
MainVolume Multi Pad	○	-	Multi Pad	-	○	○	-
MainVolume Left	○	○	Acmp.	-	○	○	-
MainVolume Right1	○	○	Voice	-	○	○	-
MainVolume Right2	○	○	Voice	-	○	○	-
MainVolume Lead	○	○	Voice	-	○	○	-
MainVolume Mic	○	-	Mic	MicSetting	○	○	-
Acmp. Rhythm1 Volume	○	-	Acmp.	-	○	-	-
Acmp. Rhythm2 Volume	○	-	Acmp.	-	○	-	-
Acmp. Bass Volume	○	-	Acmp.	-	○	-	-
Acmp. Chord1 Volume	○	-	Acmp.	-	○	-	-
Acmp. Chord2 Volume	○	-	Acmp.	-	○	-	-
Acmp. Pad Volume	○	-	Acmp.	-	○	-	-
Acmp. Phrase1 Volume	○	-	Acmp.	-	○	-	-
Acmp. Phrase2 Volume	○	-	Acmp.	-	○	-	-
Song Track Volume (Track1~16)	-	-	-	-	-	-	-
Acmp. Large/Small	○	○	Acmp.	-	○	○	-
Left Portamento	○	○	Acmp.	-	○	○	-
Right1 Portamento	○	○	Voice	-	○	○	-
Right2 Portamento	○	○	Voice	-	○	○	-
Lead Portamento	○	○	Voice	-	○	○	-
Acmp. Rhythm1 Track On/Off	○	○	Acmp.	-	○	-	-
Acmp. Rhythm2 Track On/Off	○	○	Acmp.	-	○	-	-
Acmp. Bass Track On/Off	○	○	Acmp.	-	○	-	-
Acmp. Chord1 Track On/Off	○	○	Acmp.	-	○	-	-
Acmp. Chord2 Track On/Off	○	○	Acmp.	-	○	-	-
Acmp. Pad Track On/Off	○	○	Acmp.	-	○	-	-
Acmp. Phrase1 Track On/Off	○	○	Acmp.	-	○	-	-
Acmp. Phrase2 Track On/Off	○	○	Acmp.	-	○	-	-
Song Track On/Off (Track1~16)	-	-	-	-	-	-	-

	Registration	One Touch Setting	Freeze Group	Parameter Lock	Setup (Disk) #1	Backup	Voice Set Group
<b>MIXING CONSOLE (FULL)</b>							
MainVolume Song	FADER	←	←	←	←	←	←
MainVolume Acmp.	FADER	←	←	←	←	←	←
MainVolume Multi Pad	FADER	←	←	←	←	←	←
MainVolume Left	FADER	←	←	←	←	←	←
MainVolume Right1	FADER	←	←	←	←	←	←
MainVolume Right2	FADER	←	←	←	←	←	←
MainVolume Lead	FADER	←	←	←	←	←	←
MainVolume Mic	FADER	←	←	←	←	←	←
Song Panpot	○	-	Song	-	○	○	-
Acmp. Panpot	○	-	Acmp.	-	○	○	-
Multi Pad Panpot	○	-	Multi Pad	-	○	○	-
Left Panpot	○	○	Acmp.	-	○	○	-
Right1 Panpot	○	○	Voice	-	○	○	-
Right2 Panpot	○	○	Voice	-	○	○	-
Lead Panpot	○	○	Voice	-	○	○	-
Mic Panpot	○	-	Mic	MicSetting	○	○	-
Song EQ Low	○	-	Song	-	○	○	-
Acmp. EQ Low	○	-	Acmp.	-	○	○	-
Multi Pad EQ Low	○	-	Multi Pad	-	○	○	-
Left EQ Low	○	○	Acmp.	-	○	○	EQ
Right1 EQ Low	○	○	Equalizer	-	○	○	EQ
Right2 EQ Low	○	○	Equalizer	-	○	○	EQ
Lead EQ Low	○	○	Equalizer	-	○	○	EQ
Song EQ High	○	-	Song	-	○	○	-
Acmp. EQ High	○	-	Acmp.	-	○	○	-
Multi Pad EQ High	○	-	Multi Pad	-	○	○	-
Left EQ High	○	○	Acmp.	-	○	○	EQ
Right1 EQ High	○	○	Equalizer	-	○	○	EQ
Right2 EQ High	○	○	Equalizer	-	○	○	EQ
Lead EQ High	○	○	Equalizer	-	○	○	EQ
Mic HPF	○	-	Mic	MicSetting	○	○	-
Mic Harmony HPF	○	-	Mic	MicSetting	○	○	-
Acmp. Rhythm1 Volume	FADER	←	←	←	←	←	←
Acmp. Rhythm2 Volume	FADER	←	←	←	←	←	←
Acmp. Bass Volume	FADER	←	←	←	←	←	←
Acmp. Chord1 Volume	FADER	←	←	←	←	←	←
Acmp. Chord2 Volume	FADER	←	←	←	←	←	←
Acmp. Pad Volume	FADER	←	←	←	←	←	←
Acmp. Phrase1 Volume	FADER	←	←	←	←	←	←
Acmp. Phrase2 Volume	FADER	←	←	←	←	←	←
Acmp. Rhythm1 Panpot	○	-	Acmp.	-	○	-	-
Acmp. Rhythm2 Panpot	○	-	Acmp.	-	○	-	-
Acmp. Bass Panpot	○	-	Acmp.	-	○	-	-
Acmp. Chord1 Panpot	○	-	Acmp.	-	○	-	-
Acmp. Chord2 Panpot	○	-	Acmp.	-	○	-	-
Acmp. Pad Panpot	○	-	Acmp.	-	○	-	-
Acmp. Phrase1 Panpot	○	-	Acmp.	-	○	-	-
Acmp. Phrase2 Panpot	○	-	Acmp.	-	○	-	-
Acmp. Rhythm1 EQ Low	○	-	Acmp.	-	○	-	-
Acmp. Rhythm2 EQ Low	○	-	Acmp.	-	○	-	-
Acmp. Bass EQ Low	○	-	Acmp.	-	○	-	-
Acmp. Chord1 EQ Low	○	-	Acmp.	-	○	-	-
Acmp. Chord2 EQ Low	○	-	Acmp.	-	○	-	-
Acmp. Pad EQ Low	○	-	Acmp.	-	○	-	-

# Parameter Chart

	Registration	One Touch Setting	Freeze Group	Parameter Lock	Setup (Disk) #1	Backup	Voice Set Group
Acmp. Phrase1 EQ Low	○	-	Acmp.	-	○	-	-
Acmp. Phrase2 EQ Low	○	-	Acmp.	-	○	-	-
Acmp. Rhythm1 EQ High	○	-	Acmp.	-	○	-	-
Acmp. Rhythm2 EQ High	○	-	Acmp.	-	○	-	-
Acmp. Bass EQ High	○	-	Acmp.	-	○	-	-
Acmp. Chord1 EQ High	○	-	Acmp.	-	○	-	-
Acmp. Chord2 EQ High	○	-	Acmp.	-	○	-	-
Acmp. Pad EQ High	○	-	Acmp.	-	○	-	-
Acmp. Phrase1 EQ High	○	-	Acmp.	-	○	-	-
Acmp. Phrase2 EQ High	○	-	Acmp.	-	○	-	-
Song Track Volume (Track1~16)	FADER	<-	<-	<-	<-	<-	<-
Song Track Panpot (Track1~16)	-	-	-	-	-	-	-
Song Track EQ Low (Track1~16)	-	-	-	-	-	-	-
Song Track EQ High (Track1~16)	-	-	-	-	-	-	-
Song Reverb Depth	○	-	Song	-	○	○	-
Acmp. Reverb Depth	○	-	Acmp.	-	○	○	-
Multi Pad Reverb Depth	○	-	Multi Pad	-	○	○	-
Left Reverb Depth	○	○	Acmp.	-	○	○	VOICE
Right1 Reverb Depth	○	○	Effects	-	○	○	VOICE
Right2 Reverb Depth	○	○	Effects	-	○	○	VOICE
Lead Reverb Depth	○	○	Effects	-	○	○	VOICE
Mic Reverb Depth	○	-	Mic	MicSetting	○	○	-
Song Chorus Depth	○	-	Song	-	○	○	-
Acmp. Chorus Depth	○	-	Acmp.	-	○	○	-
Multi Pad Chorus Depth	○	-	Multi Pad	-	○	○	-
Left Chorus Depth	○	○	Acmp.	-	○	○	VOICE
Right1 Chorus Depth	○	○	Effects	-	○	○	VOICE
Right2 Chorus Depth	○	○	Effects	-	○	○	VOICE
Lead Chorus Depth	○	○	Effects	-	○	○	VOICE
Mic Chorus Depth	○	-	Mic	MicSetting	○	○	-
Right1 DSP Depth	○	○	Effects	-	○	○	DSP
Right2 DSP Depth	○	○	Effects	-	○	○	DSP
Lead DSP Depth	○	○	Effects	-	○	○	DSP
Mic DSP Depth	○	-	Mic	MicSetting	○	○	-
Song DSP3 Depth	-	-	Song	-	○	○	-
Acmp. DSP3 Depth	-	-	Acmp.	-	○	○	-
Acmp. Rhythm1 Reverb Depth	○	-	Acmp.	-	○	-	-
Acmp. Rhythm2 Reverb Depth	○	-	Acmp.	-	○	-	-
Acmp. Bass Reverb Depth	○	-	Acmp.	-	○	-	-
Acmp. Chord1 Reverb Depth	○	-	Acmp.	-	○	-	-
Acmp. Chord2 Reverb Depth	○	-	Acmp.	-	○	-	-
Acmp. Pad Reverb Depth	○	-	Acmp.	-	○	-	-
Acmp. Phrase1 Reverb Depth	○	-	Acmp.	-	○	-	-
Acmp. Phrase2 Reverb Depth	○	-	Acmp.	-	○	-	-
Acmp. Rhythm1 Chorus Depth	○	-	Acmp.	-	○	-	-
Acmp. Rhythm2 Chorus Depth	○	-	Acmp.	-	○	-	-
Acmp. Bass Chorus Depth	○	-	Acmp.	-	○	-	-
Acmp. Chord1 Chorus Depth	○	-	Acmp.	-	○	-	-
Acmp. Chord2 Chorus Depth	○	-	Acmp.	-	○	-	-
Acmp. Pad Chorus Depth	○	-	Acmp.	-	○	-	-
Acmp. Phrase1 Chorus Depth	○	-	Acmp.	-	○	-	-
Acmp. Phrase2 Chorus Depth	○	-	Acmp.	-	○	-	-
Acmp. Rhythm1 DSP3 Depth	-	-	Acmp.	-	○	-	-
Acmp. Rhythm2 DSP3 Depth	-	-	Acmp.	-	○	-	-
Acmp. Bass DSP3 Depth	-	-	Acmp.	-	○	-	-

	Registration	One Touch Setting	Freeze Group	Parameter Lock	Setup (Disk) #1	Backup	Voice Set Group
Acmp. Chord1 DSP3 Depth	-	-	Acmp.	-	○	-	-
Acmp. Chord2 DSP3 Depth	-	-	Acmp.	-	○	-	-
Acmp. Pad DSP3 Depth	-	-	Acmp.	-	○	-	-
Acmp. Phrase1 DSP3 Depth	-	-	Acmp.	-	○	-	-
Acmp. Phrase2 DSP3 Depth	-	-	Acmp.	-	○	-	-
Song Track Reverb Depth (Track1~16)	-	-	-	-	-	-	-
Song Track Chorus Depth (Track1~16)	-	-	-	-	-	-	-
Song Track DSP3 Depth (Track1~16)	-	-	-	-	-	-	-
Reverb Effect Type	○	-	Acmp.	-	○	○	-
Chorus Effect Type	○	-	Acmp.	-	○	○	-
Right1 DSP Effect Type	○	○	Effects	-	○	○	DSP
Right2 DSP Effect Type	○	○	Effects	-	○	○	DSP
Lead DSP Effect Type	○	○	Effects	-	○	○	DSP
Mic DSP Effect Type	○	-	Mic	MicSetting	○	○	-
DSP3 Effect Type	-	-	Acmp.	-	○	○	-
Vocal Harmony Effect Type	○	-	Mic	MicSetting	○	○	-
Reverb Effect Parameter 1...16 Value	-	-	-	-	-	○	-
Chorus Effect Parameter 1...16 Value	-	-	-	-	-	○	-
Lead DSP Effect Parameter 1...16 Value	-	-	-	-	-	○	-
Lead DSP Variation Effect Parameter Value	-	-	-	-	-	○	-
Right1 DSP Effect Parameter 1...16 Value	-	-	-	-	-	○	-
Right1 DSP Variation Effect Parameter Value	-	-	-	-	-	○	-
Right2 DSP Effect Parameter 1...16 Value	-	-	-	-	-	○	-
Right2 DSP Variation Effect Parameter Value	-	-	-	-	-	○	-
Mic DSP Effect Parameter 1...16 Value	-	-	-	-	-	○	-
Vocal Harmony Effect Parameter (Harmony Volume)	-	-	-	-	-	○	-
Vocal Harmony Effect Parameter (Harmony Panpot)	-	-	-	-	-	○	-
Vocal Harmony Effect Parameter (Harmony Reverb Depth)	-	-	-	-	-	○	-
Vocal Harmony Effect Parameter (Harmony Chorus Depth)	-	-	-	-	-	○	-
Vocal Harmony Effect Parameter (DSP On/Off)	-	-	-	-	-	○	-
Vocal Harmony Effect Parameter (Vocal Gender)	-	-	-	-	-	○	-
Vocal Harmony Effect Parameter (Harmony Gender)	-	-	-	-	-	○	-
Vocal Harmony Effect Parameter (Detune)	-	-	-	-	-	○	-
Vocal Harmony Variation Effect Parameter Value	-	-	-	-	-	○	-
Reverb Return Level	○	-	Acmp.	Reverb Return level	○	○	-
Chorus Return Level	○	-	Acmp.	Chorus Return level	○	○	-
DSP3 Return Level	-	-	Acmp.	-	○	○	-
Master Transpose	PANEL	<-	<-	<-	<-	<-	<-
Song Transpose	○	-	Tune Trans	-	○	○	-
Left Tuning	○	○	Acmp.	-	○	○	-
Right1 Tuning	○	○	Voice	-	○	○	-
Right2 Tuning	○	○	Voice	-	○	○	-
Lead Tuning	○	○	Voice	-	○	○	-
Left Octave	○	○	Acmp.	-	○	○	VOICE

	Registration	One Touch Setting	Freeze Group	Parameter Lock	Setup (Disk) #1	Backup	Voice Set Group
Right1 Octave	○	○	Voice	-	○	○	VOICE
Right2 Octave	○	○	Voice	-	○	○	VOICE
Lead Octave	○	○	Voice	-	○	○	VOICE
Left Pitch Bend Range	○	○	Acomp.	-	○	○	-
Right1 Pitch Bend Range	○	○	Voice	-	○	○	-
Right2 Pitch Bend Range	○	○	Voice	-	○	○	-
Lead Pitch Bend Range	○	○	Voice	-	○	○	-
Left Portamento Time	○	○	Acomp.	-	○	○	-
Right1 Portamento Time	○	○	Voice	-	○	○	-
Right2 Portamento Time	○	○	Voice	-	○	○	-
Lead Portamento Time	○	○	Voice	-	○	○	-
Master EQ Type	○	-	Equalizer	Master EQ	-	○	-
Master EQ User1 EQ1 Q	-	-	-	-	-	○	-
Master EQ User1 EQ1 Freq.	-	-	-	-	-	○	-
Master EQ User1 EQ1 Gain	-	-	-	-	-	○	-
Master EQ User1 EQ2 Q	-	-	-	-	-	○	-
Master EQ User1 EQ2 Freq.	-	-	-	-	-	○	-
Master EQ User1 EQ2 Gain	-	-	-	-	-	○	-
Master EQ User1 EQ3 Q	-	-	-	-	-	○	-
Master EQ User1 EQ3 Freq.	-	-	-	-	-	○	-
Master EQ User1 EQ3 Gain	-	-	-	-	-	○	-
Master EQ User1 EQ4 Q	-	-	-	-	-	○	-
Master EQ User1 EQ4 Freq.	-	-	-	-	-	○	-
Master EQ User1 EQ4 Gain	-	-	-	-	-	○	-
Master EQ User1 EQ5 Q	-	-	-	-	-	○	-
Master EQ User1 EQ5 Freq.	-	-	-	-	-	○	-
Master EQ User1 EQ5 Gain	-	-	-	-	-	○	-
Master EQ User2 EQ1 Q	-	-	-	-	-	○	-
Master EQ User2 EQ1 Freq.	-	-	-	-	-	○	-
Master EQ User2 EQ1 Gain	-	-	-	-	-	○	-
Master EQ User2 EQ2 Q	-	-	-	-	-	○	-
Master EQ User2 EQ2 Freq.	-	-	-	-	-	○	-
Master EQ User2 EQ2 Gain	-	-	-	-	-	○	-
Master EQ User2 EQ3 Q	-	-	-	-	-	○	-
Master EQ User2 EQ3 Freq.	-	-	-	-	-	○	-
Master EQ User2 EQ3 Gain	-	-	-	-	-	○	-
Master EQ User2 EQ4 Q	-	-	-	-	-	○	-
Master EQ User2 EQ4 Freq.	-	-	-	-	-	○	-
Master EQ User2 EQ4 Gain	-	-	-	-	-	○	-
Master EQ User2 EQ5 Q	-	-	-	-	-	○	-
Master EQ User2 EQ5 Freq.	-	-	-	-	-	○	-
Master EQ User2 EQ5 Gain	-	-	-	-	-	○	-
Master EQ Edit Q(EQ1~EQ5)	-	-	-	-	-	○	-
Master EQ Edit Freq.(EQ1~EQ5)	-	-	-	-	-	○	-
Master EQ Edit Gain(EQ1~EQ5)	-	-	-	-	-	○	-

	Registration	One Touch Setting	Freeze Group	Parameter Lock	Setup (Disk) #1	Backup	Voice Set Group
Left Harmonic Content	○	○	Acomp.	-	○	○	-
Right1 Harmonic Content	○	○	Voice	-	○	○	-
Right2 Harmonic Content	○	○	Voice	-	○	○	-
Lead Harmonic Content	○	○	Voice	-	○	○	-
Acomp Part Harmonic Content (Rhy1/Rhy2/Bass/Chd1/Chd2/Pad/Phr1/Phr2)	○	-	Acomp.	-	○	-	-
Song Track Harmonic Content (Track 1 ~ 16)	-	-	-	-	○	-	-
Left Brightness	○	○	Acomp.	-	○	○	-
Right1 Brightness	○	○	Voice	-	○	○	-
Right2 Brightness	○	○	Voice	-	○	○	-
Lead Brightness	○	○	Voice	-	○	○	-
Acomp Part Brightness (Rhy1/Rhy2/Bass/Chd1/Chd2/Pad/Phr1/Phr2)	○	-	Acomp.	-	○	-	-
Song Track Brightness(Track 1 ~ 16)	-	-	-	-	-	-	-
DSP3Conection	-	-	-	-	-	○	-
DSP3Part	-	-	-	-	-	○	-
<b>DEMO/HELP</b>							
Language	-	-	-	-	○	○	-
<b>etc.</b>							
Registration(OTS) Name	○	-	-	-	-	○	-
Effect User Set Data	-	-	-	-	-	○	-
Multi Pad User Data(bank51~60)	-	-	-	-	-	○	-
Multi Pad Chord Match ON/OFF (Track1~60)	-	-	-	-	-	○	-
Multi Pad Repeat ON/OFF(Track1~60)	-	-	-	-	-	○	-

# Effect Signal Flow Chart

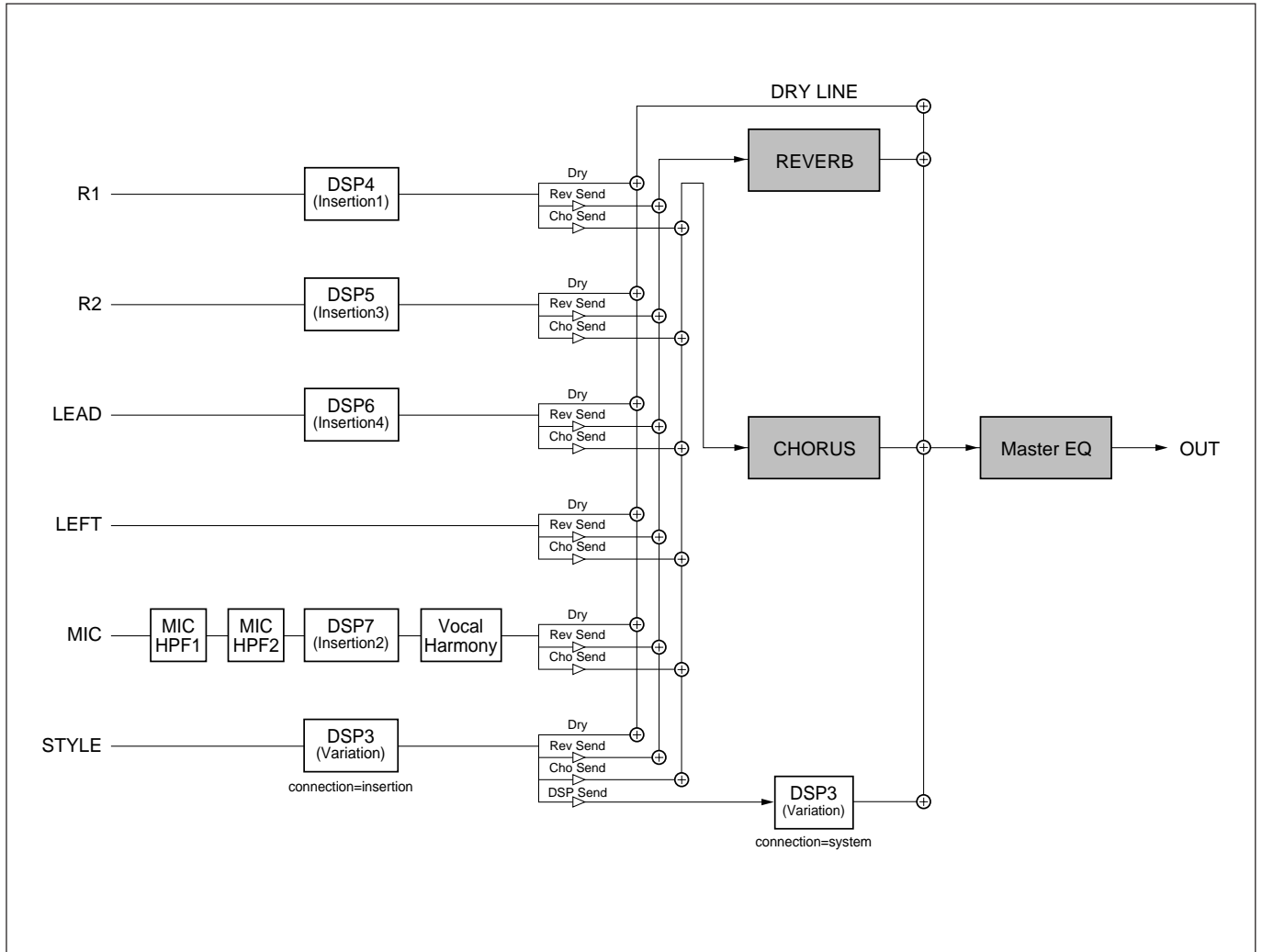



# MIDI Data Format

Many MIDI messages listed in the MIDI Data Format are expressed in decimal numbers, binary numbers and hexadecimal numbers. Hexadecimal numbers may include the letter "H" as a suffix. Also, "n" can freely be defined as any whole number.

To enter data/values, refer to the table below.

Decimal	Hexadecimal	Binary
0	00	0000 0000
1	01	0000 0001
2	02	0000 0010
3	03	0000 0011
4	04	0000 0100
5	05	0000 0101
6	06	0000 0110
7	07	0000 0111
8	08	0000 1000
9	09	0000 1001
10	0A	0000 1010
11	0B	0000 1011
12	0C	0000 1100
13	0D	0000 1101
14	0E	0000 1110
15	0F	0000 1111
16	10	0001 0000
17	11	0001 0001
18	12	0001 0010
19	13	0001 0011
20	14	0001 0100
21	15	0001 0101
22	16	0001 0110
23	17	0001 0111
24	18	0001 1000
25	19	0001 1001
26	1A	0001 1010
27	1B	0001 1011
28	1C	0001 1100
29	1D	0001 1101
30	1E	0001 1110
31	1F	0001 1111
32	20	0010 0000
33	21	0010 0001
34	22	0010 0010
35	23	0010 0011
36	24	0010 0100
37	25	0010 0101
38	26	0010 0110
39	27	0010 0111
40	28	0010 1000
41	29	0010 1001
42	2A	0010 1010
43	2B	0010 1011
44	2C	0010 1100
45	2D	0010 1101
46	2E	0010 1110
47	2F	0010 1111
48	30	0011 0000
49	31	0011 0001
50	32	0011 0010
51	33	0011 0011
52	34	0011 0100
53	35	0011 0101
54	36	0011 0110
55	37	0011 0111
56	38	0011 1000
57	39	0011 1001
58	3A	0011 1010
59	3B	0011 1011
60	3C	0011 1100
61	3D	0011 1101
62	3E	0011 1110
63	3F	0011 1111

- Except the table above, for example 144-159(decimal)/9nH/1001 0000-1001 1111(binary) displays the Note On Message for each channel (1-16). 176-191/ BnH/1011 0000-1011 1111 displays the Control Change Message for each channel (1-16). 192-207/CnH/1100 0000-1100 1111 displays the Program Change Message for each channel (1-16). 240/FOH/1111 0000 denotes the start of a System Exclusive Message. 247/F7H/1111 0111 denotes the end of a System Exclusive Message.
- aaH (hexidecimal)/0aaaaaaa (binary) denotes the data address. The address contains High, Mid, and Low.
- bbH/0bbbbbbb denotes the byte count.
- ccH/0ccccccc denotes the check sum.
- ddH/0ddddddd denotes the data/value.

## (1) TRANSMIT FLOW

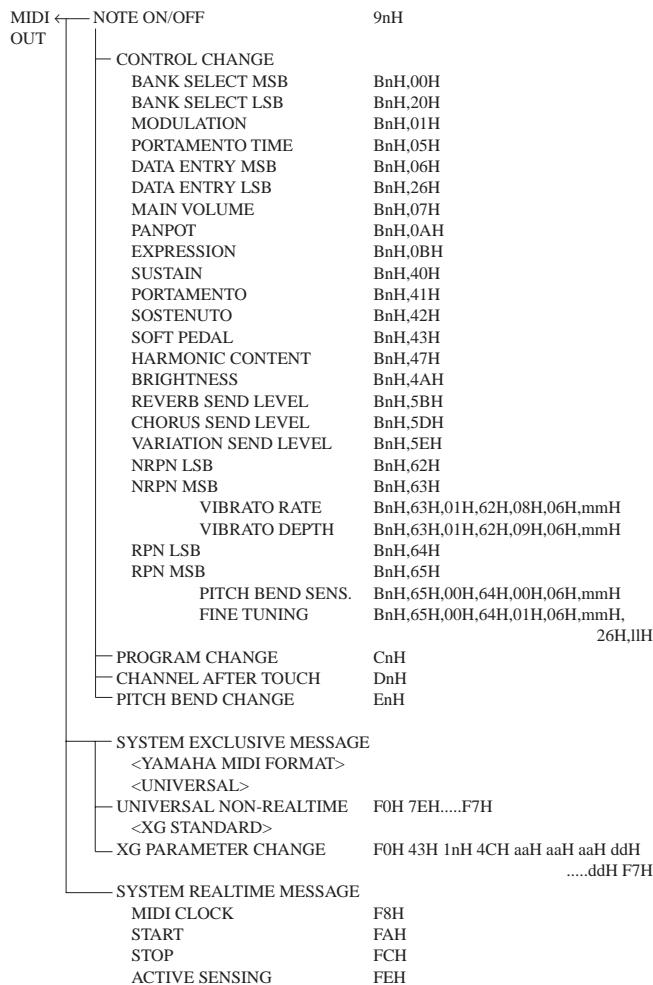

## (2) RECEIVE FLOW

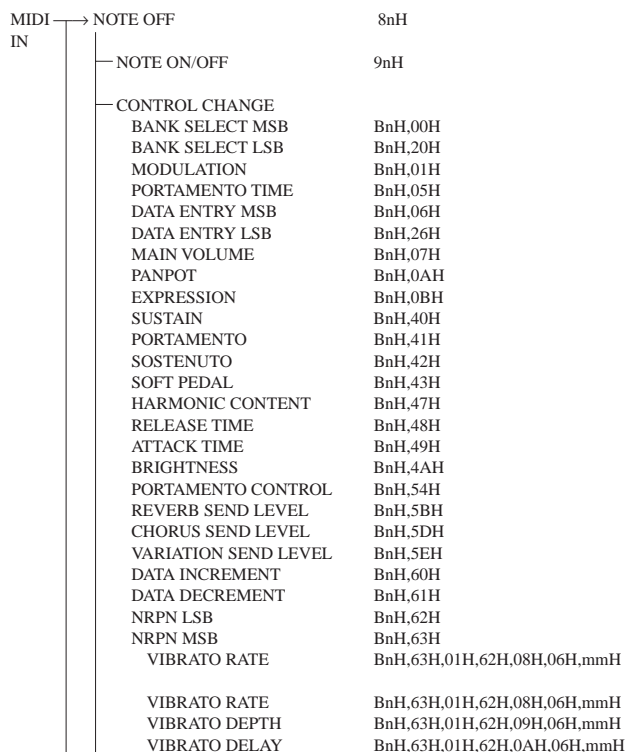

FILTER CUTOFF FREQ.	BnH,63H,01H,62H,20H,06H,mmH
FILTER RESONANCE	BnH,63H,01H,62H,21H,06H,mmH
AEG ATTACK TIME	BnH,63H,01H,62H,63H,06H,mmH
AEG DECAY TIME	BnH,63H,01H,62H,64H,06H,mmH
AEG RELEASE	BnH,63H,01H,62H,66H,06H,mmH
DRUM INST	
CUTOFF FREQ.	BnH,63H,14H,62H,rrH,06H,mmH
FILTER RESONANCE	BnH,63H,15H,62H,rrH,06H,mmH
AEG ATTACK RATE	BnH,63H,16H,62H,rrH,06H,mmH
AEG DECAY RATE	BnH,63H,17H,62H,rrH,06H,mmH
PITCH COARSE	BnH,63H,18H,62H,rrH,06H,mmH
PITCH FINE	BnH,63H,19H,62H,rrH,06H,mmH
LEVEL	BnH,63H,1AH,62H,rrH,06H,mmH
PANPOT	BnH,63H,1CH,62H,rrH,06H,mmH
REVERB SEND	BnH,63H,1DH,62H,rrH,06H,mmH
CHORUS SEND	BnH,63H,1EH,62H,rrH,06H,mmH
VARIATION SEND	BnH,63H,1FH,62H,rrH,06H,mmH
RPN LSB	BnH,64H
RPN MSB	BnH,65H
PITCH BEND SENS.	BnH,65H,00H,64H,00H,06H,mmH
FINE TUNING	BnH,65H,00H,64H,01H,06H,mmH, 26H,IH
COARSE TUNING	BnH,65H,00H,64H,02H,06H,mmH
NULL	BnH,65H,7FH,64H,7FH
ALL SOUND OFF	BnH,78H,00H
RESET ALL CONTROLLERS	BnH,79H,00H
ALL NOTES OFF	BnH,7BH,00H
OMNI OFF	BnH,7CH,00H
OMNI ON	BnH,7DH,00H
MONO	BnH,7EH
POLY	BnH,7FH
PROGRAM CHANGE	CnH
CHANNEL AFTER TOUCH	DnH
PITCH BEND CHANGE	EnH
SYSTEM EXCLUSIVE MESSAGE	
<YAMAHA MIDI FORMAT>	
<UNIVERSAL>	
UNIVERSAL REALTIME	F0H 7FH.....F7H
UNIVERSAL NON-REALTIME	F0H 7EH.....F7H
<XG STANDARD>	
XG PARAMETER CHANGE	F0H 43H 1nH 4CH aaH aaH aaH ddH .....ddH F7H
XG BULK DUMP	F0H 43H 0nH 4CH bbH bbH aaH aaH aaH ddH.....ddH ccH F7H
PARAMETER REQUEST	F0H 43H 3nH 4CH aaH aaH aaH F7H
DUMP REQUEST	F0H 43H 2nH 4CH aaH aaH aaH F7H
<SPETIAL OPERATORS>	
<Others>	
SYSTEM REALTIME MESSAGE	
MIDI CLOCK	F8H
START	FAH
STOP	FCH
ACTIVE SENSING	FEH

### (3-1-6) CONTROL CHANGE

STATUS	1011nnnn (BnH)	n = 0 - 15 VOICE CHANNEL NUMBER
CONTROL NUMBER	0ccccccc	
CONTROL VALUE	0vvvvvvv	

#### \* Transmit CONTROL NUMBER.

c = 0	BANK SELECT MSB	; v = 0: XG NORMAL, 64: SFX NORMAL, 126: XG SFX KIT, 127: XG DRUM	
c = 32	BANK SELECT LSB	; v = 0 - 127	*3
c = 1	MODULATION	; v = 0 - 127	*2
c = 5	PORTAMENTO TIME	; v = 0 - 127	*2
c = 6	DATA ENTRY MSB	; v = 0 - 127	*1
c = 38	DATA ENTRY LSB	; v = 0 - 127	*1
c = 7	MAIN VOLUME	; v = 0 - 127	
c = 10	PANPOT	; v = 0 - 127	
c = 11	EXPRESSION	; v = 0 - 127	
c = 64	SUSTAIN	; v = 0-63: OFF, 64-127: ON	*2
c = 65	PORTAMENTO	; v = 0-63: OFF, 64-127: ON	*2
c = 66	SOSTENUTO	; v = 0-63: OFF, 64-127: ON	*2
c = 67	SOFT PEDAL	; v = 0-63: OFF, 64-127: ON	*2
c = 71	HARMONIC CONTENT	; v = 0-64 - 64:0 - 127:+63	*2
c = 74	BRIGHTNESS	; v = 0-64 - 64:0 - 127:+63	*2
c = 91	REVERB SEND LEVEL	; v = 0 - 127	
c = 93	CHORUS SEND LEVEL	; v = 0 - 127	
c = 94	VARIATION SEND LEVEL	; v = 0 - 127	

(When only Connection = 1[System])

#### \* Receive CONTROL NUMBER.

c = 0	BANK SELECT MSB	; v = 0: XG NORMAL, 64: SFX NORMAL, 126: XG SFX KIT, 127: XG DRUM	
c = 32	BANK SELECT LSB	; v = 0 - 127	*3
c = 1	MODULATION	; v = 0 - 127	*2
c = 5	PORTAMENTO TIME	; v = 0 - 127	*2
c = 6	DATA ENTRY MSB	; v = 0 - 127	*1
c = 38	DATA ENTRY LSB	; v = 0 - 127	*1
c = 7	MAIN VOLUME	; v = 0 - 127	
c = 10	PANPOT	; v = 0 - 127	
c = 11	EXPRESSION	; v = 0 - 127	
c = 64	SUSTAIN	; v = 0-63: OFF, 64-127: ON	*2
c = 65	PORTAMENTO	; v = 0-63: OFF, 64-127: ON	*2
c = 66	SOSTENUTO	; v = 0-63: OFF, 64-127: ON	*2
c = 67	SOFT PEDAL	; v = 0-63: OFF, 64-127: ON	*2
c = 71	HARMONIC CONTENT	; v = 0-64 - 64:0 - 127:+63	*2
c = 72	RELEASE TIME	; v = 0-64 - 64:0 - 127:+63	*2
c = 73	ATTACK TIME	; v = 0-64 - 64:0 - 127:+63	*2
c = 74	BRIGHTNESS	; v = 0-64 - 64:0 - 127:+63	*2
c = 84	PORTAMENTO CONTROL	; v = 0 - 127	*2
c = 91	REVERB SEND LEVEL	; v = 0 - 127	
c = 93	CHORUS SEND LEVEL	; v = 0 - 127	
c = 94	VARIATION SEND LEVEL	; v = 0 - 127	

(When only Connection = 1[System])

c = 96	DATA INCREMENT	; v = 127	*1
c = 97	DATA DECREMENT	; v = 127	*1

\*1 Only when setting the appointed parameter with RPN, NRPN.  
\*2 Does not effect Rhythm Voice.  
\*3 MSB=0, anything other than 63 is 0.

- Until a PROGRAM CHANGE message is received, the BANK SELECT operation will be suspended. When a Voice, including VOICE BANK, is changed, set the BANK SELECT and Program Change Message, and transmit in the following order, BANK SELECT MSB, LSB, PROGRAM CHANGE.
- MODULATION controls the Vibrato Depth.
- PORTAMENTO TIME controls the Pitch Change Speed when the Portamento Switch = ON. 0 being the shortest time, and 127 being the longest.
- PANPOT changes the value for the melody voice and rhythm voice in relation to the preset value.
- Portamento time is fixed to 0 when the PORTAMENTO CONTROL is used.
- HARMONIC CONTENT applies adjustment to the resonance value that is set by the voice. This parameter specifies relative change with the value of 64 producing 0 adjustment. As values get higher the sound becomes increasingly eccentric. Note that for some voices the effective parameter range is narrower than the legal parameter range.
- RELEASE TIME applies adjustment to the envelope release time set by the voice. This parameter specifies relative change with the value of 64 producing 0 adjustment.

## (3) TRANSMIT/RECEIVE DATA

### (3-1) CHANNEL VOICE MESSAGES

#### (3-1-1) NOTE OFF (Receive only)

STATUS	1000nnnn (8nH)	n = 0 - 15 VOICE CHANNEL NUMBER
NOTE NUMBER	0kkkkkkk	k = 0 (C-2) - 127 (G8)
VELOCITY	0vvvvvvv	v: ignored

#### (3-1-2) NOTE ON/OFF

STATUS	1001nnnn (9nH)	n = 0 - 15 VOICE CHANNEL NUMBER
NOTE NUMBER	0kkkkkkk	k = 0 (C-2) - 127 (G8)
VELOCITY	0vvvvvvv	(v ≠ 0) NOTE ON (v = 0) NOTE OFF

#### (3-1-3) PROGRAM CHANGE

STATUS	1100nnnn (CnH)	n = 0 - 15 VOICE CHANNEL NUMBER
PROGRAM NUMBER	0ppppppp	p = 0 - 127

#### (3-1-4) CHANNEL AFTER TOUCH

STATUS	1101nnnn (DnH)	n = 0 - 15 VOICE CHANNEL NUMBER
VALUE	0vvvvvvv	v = 0 - 127 AFTER TOUCH VALUE

#### (3-1-5) PITCH BEND CHANGE

STATUS	1110nnnn (EnH)	n = 0 - 15 VOICE CHANNEL NUMBER
LSB	0vvvvvvv	PITCH BEND CHANGE LSB
MSB	0vvvvvvv	PITCH BEND CHANGE MSB

- **ATTACK TIME** applies adjustment to the envelope attack time set by the voice. This parameter specifies relative change with the value of 64 producing 0 adjustment.
- **BRIGHTNESS** applies adjustment to the cut-off frequency set by the voice. This parameter specifies relative change with the value of 64 producing 0 adjustment. Lower voices produce a softer sound. For some voices the effective parameter range is narrower than the legal parameter range.

### (3-2) CHANNEL MODE MESSAGES

STATUS 1011nnnn (BnH) n = 0 - 15 VOICE CHANNEL NUMBER  
 CONTROL NUMBER 0ccccccc c = CONTROL NUMBER  
 CONTROL VALUE 0vvvvvvv v = DATA VALUE

#### (3-2-1) ALL SOUND OFF (Receive only)

(CONTROL NUMBER = 78H, DATA VALUE = 0)

Switches off all sound from the channel. Does not reset Note On and Hold On conditions established by Channel Messages.

#### (3-2-2) RESET ALL CONTROLLERS (Receive only)

(CONTROL NUMBER = 79H, DATA VALUE = 0)

Resets controllers as follows.

PITCH BEND CHANGE 0 (Center)  
 AFTER TOUCH 0 (min.)  
 MODULATION 0 (min.)  
 EXPRESSION 127 (max.)  
 SUSTAIN 0 (off)  
 SOSTENUTO 0 (off)  
 SOFT PEDAL 0 (off)  
 NRPN Sets number to null. (Internal data remains unchanged)  
 RPN Sets number to null. (Internal data remains unchanged)  
 PORTAMENT CONTROL Resets portamento source note number  
 PORTAMENTO 0 (off)

#### (3-2-3) ALL NOTES OFF (Receive only)

(CONTROL NUMBER = 7BH, DATA VALUE = 0)

Switches off all of the channel's "on" notes. However, any notes being held by SUSTAIN or SOSTENUTO continue to sound until SUSTAIN/SOSTENUTO goes off.

#### (3-2-4) OMNI OFF (Receive only) (CONTROL NUMBER = 7CH, DATA VALUE = 0)

Same processing as for All Notes Off.

#### (3-2-5) OMNI ON (Receive only) (CONTROL NUMBER = 7DH, DATA VALUE = 0)

Same processing as for All Notes Off. Omni On is not executed.

#### (3-2-6) MONO (Receive only) (CONTROL NUMBER = 7EH, DATA VALUE = 0 - 16)

Same processing as for All Sounds Off. If the 3rd byte is in a range of 0-16 the corresponding channel will be changed to Mode 4 (m=1).

#### (3-2-7) POLY (Receive only) (CONTROL NUMBER = 7FH, DATA VALUE = 0)

Same processing as for All Sounds Off and the corresponding channel will be changed to Mode 3.

### (3-3) REGISTERED PARAMETER NUMBER (RPN)

STATUS 1011nnnn (BnH) n = 0 - 15 VOICE CHANNEL NUMBER  
 RPN LSB 01100100 (64H)  
 RPN LSB NUMBER 0ppppppp pp = RPN LSB (refer to the list below)  
 RPN MSB 01100101 (65H)  
 RPN MSB NUMBER 0qqqqqqq qq = RPN MSB (refer to the list below)  
 DATA ENTRY MSB 00000110 (06H)  
 DATA VALUE 0mmmmmmm mm = Data Value  
 DATA ENTRY LSB 00100110 (26H)  
 DATA VALUE 0lllllll ll = Data Value

First appoints the parameter for RPN MSB/LSB, then sets the parameter value for data entry MSB/LSB.

RPN	D.ENTRY	LSB MSB	MSB LSB	PARAMETER NAME	DATA RANGE
00H 00H	mmH —			PITCH BEND SENSITIVITY	00H - 18H (0 - 24 semitones)
01H 00H	mmH llH			FINE TUNE	(mmH, llH) = (00H, 00H) - (40H, 00H) - (7FH, 7FH) (-8192*100/8192) - 0 - (+8192*100/8192)
02H 00H	mmH —			COARSE TUNE	28H - 40H - 58H (-24 - 0 - +24 semitones)
7FH 7FH	— —			NULL	

Clears the current RPN number setting. Does not change the internal parameter settings.

### (3-4) NON-REGISTERED PARAMETER NUMBER (NRPN)

STATUS 1011nnnn (BnH) n = 0 - 15 VOICE CHANNEL NUMBER  
 NRPN LSB 01100010 (62H)  
 NRPN LSB NUMBER 0ppppppp pp = NRPN LSB (refer to the list below)  
 NRPN MSB 01100011 (63H)  
 NRPN MSB NUMBER 0qqqqqqq qq = NRPN MSB (refer to the list below)  
 DATA ENTRY MSB 00000110 (06H)  
 DATA VALUE 0mmmmmmm mm = Data Value

First appoints the parameter for NRPN MSB/LSB, then sets the parameter value for data entry MSB/LSB.

NRPN	D.ENTRY	MSB LSB	MSB LSB	PARAMETER NAME	DATA RANGE
01H 08H	mmH —			VIBRATO RATE	00H - 40H - 7FH (-64 - 0 - +63)
01H 09H	mmH —			VIBRATO DEPTH	00H - 40H - 7FH (-64 - 0 - +63)
01H 0AH	mmH —			VIBRATO DELAY	00H - 40H - 7FH (-64 - 0 - +63)
01H 20H	mmH —			FILTER CUTOFF FREQUENCY	00H - 40H - 7FH (-64 - 0 - +63)
01H 21H	mmH —			FILTER RESONANCE	00H - 40H - 7FH (-64 - 0 - +63)
01H 63H	mmH —			EG ATTACK TIME	00H - 40H - 7FH (-64 - 0 - +63)
01H 64H	mmH —			EG DECAY TIME	00H - 40H - 7FH (-64 - 0 - +63)
01H 66H	mmH —			EG RELEASE	00H - 40H - 7FH (-64 - 0 - +63)
14H rrH	mmH —			DRUM FILTER CUTOFF FREQ.	00H - 40H - 7FH (-64 - 0 - +63)
15H rrH	mmH —			DRUM FILTER RESONANCE	00H - 40H - 7FH (-64 - 0 - +63)
16H rrH	mmH —			DRUM AEG ATTACK RATE	00H - 40H - 7FH (-64 - 0 - +63)
17H rrH	mmH —			DRUM AEG DECAY RATE	00H - 40H - 7FH (-64 - 0 - +63)
18H rrH	mmH —			DRUM PITCH COARSE	00H - 40H - 7FH (-64 - 0 - +63)
19H rrH	mmH —			DRUM PITCH FINE	00H - 40H - 7FH (-64 - 0 - +63)
1AH rrH	mmH —			DRUM LEVEL	00H - 7FH (0 - max.)
1CH rrH	mmH —			DRUM PANPOT	00H , 01H - 40H - 7FH (random, left - center - right)
1DH rrH	mmH —			DRUM REVERB SEND LEVEL	00H - 7FH (0 - max.)
1EH rrH	mmH —			DRUM CHORUS SEND LEVEL	00H - 7FH (0 - max.)
1FH rrH	mmH —			DRUM VARIATION SEND LEVEL	00H - 7FH (0 - max.)

The MSG14H-1FH (for drums) message is accepted as long as the channel is set with a drum voice.

rrH : drum instrument note number

### (3-5) SYSTEM REALTIME MESSAGES

#### (3-5-1) MIDI CLOCK

STATUS 11111000 (F8H)

**Transmission:** 96 clocks per measure are transmitted.

**Reception:** If the instrument's clock is set to external, after FAH is received from the external device the instrument's clock will sync with the 96 beats per measure received from the external device.

Decides whether the internal clock, or Timing Clocks received via the MIDI IN will be used.

#### (3-5-2) START

STATUS 11111010 (FAH)

**Transmission:** Transmitted when instrument's Rhythm or Song playback is started.

**Reception:** If the instrument's clock is set to external, Rhythm, Song Playback, or Song Rec will start.

#### (3-5-3) STOP

STATUS 11111100 (FCH)

**Transmission:** Transmitted when instrument's Rhythm or Song playback is stopped.

**Reception:** If the instrument's clock is set to external, Rhythm, Song Playback, or Song Rec will stop.

#### (3-5-4) ACTIVE SENSING

STATUS 11111110 (FEH)

**Transmission:** Transmitted approximately once every 200msec.

**Reception:** Sensing is started once this Code is received. If Status or Data is not received within 400ms, the MIDI Receive Buffer will be cleared, and all notes, including those being sustained, will be cut OFF. Also, all control values will be reset to their factory defaults.

### (3-6) SYSTEM EXCLUSIVE MESSAGE

#### (3-6-1) YAMAHA MIDI FORMAT

##### (3-6-1-1) SECTION CONTROL

binary	hexadecimal	Exclusive status
11110000	F0	YAMAHA ID
01000011	43	Style
01111110	7E	Style
00000000	00	Switch No.
0sssssss	SS	Switch No.
00H		: INTRO A
01H-07H		: INTRO B
08H		: MAIN A
09H-0FH		: MAIN B
10H		: FILL IN AA
11H-17H		: FILL IN BB
18H		: FILL IN AB
19H-1FH		: FILL IN BA
20H		: ENDING A
21H-27H		: ENDING B
0ddddd	DD	Switch On/Off : 00H (Off), 7FH (On)
11110111	F7	End of Exclusive

When an ON code is received, the appointed section will be changed.

# MIDI Data Format

## (3-6-1-2) TEMPO CONTROL

binary	hexadecimal	
11110000	F0	Exclusive status
01000011	43	YAMAHA ID
01111110	7E	Style
00000000	01	
0ttttttt	TT	Tempo4
0ttttttt	TT	Tempo3
0ttttttt	TT	Tempo2
0ttttttt	TT	Tempo1
11110111	F7	End of Exclusive

The internal clock will be set to the received Tempo value.

Tempo Meta Event is a large data block (24-bit), it is divided into 4 groups with 7-bits going into each of the Tempos 1-4 (4 receives the remaining 3 bits).

## (3-6-1-3) CHORD CONTROL type1

binary	hexadecimal	
11110000	F0	Exclusive status
01000011	43	YAMAHA ID
01111110	7E	Style
00000010	02	type 1
0ddddddd	dd	chord root(cr)
0ddddddd	dd	chord type(ct)
0ddddddd	dd	bass note(bn)
0ddddddd	dd	bass type(bt)
11111110	F7	End of Exclusive

Chord transmit: Transmitted using type 1 format.

cr Chord Root Okkknnnn (kkk: Change symbol, nnnn: Note)

Binary	Hex	Change symbol	Binary	Hex	Note
0000nnnn	0n	bbb(3 flats)	0kkk0000	k0	reserved
0001nnnn	1n	bb (2 flats)	0kkk0001	k1	C
0010nnnn	2n	b (1 flat)	0kkk0010	k2	D
0011nnnn	3n	natural	0kkk0011	k3	E
0100nnnn	4n	# (1 sharp)	0kkk0100	k4	F
0101nnnn	5n	## (2 sharps)	0kkk0101	k5	G
0110nnnn	6n	###(3 sharps)	0kkk0110	k6	A
			0kkk0111	k7	B

ct Chord Type 0 - 34,127

Binary	Hex	Dec	Chord type	Binary	Hex	Dec	Chord type
00000000	00	0	Maj	00010010	12	18	dim7
00000001	01	1	Maj6	00010011	13	19	7th
00000010	02	2	Maj7	00010100	14	20	7sus4
00000011	03	3	Maj7(#11)	00010101	15	21	7b5
00000100	04	4	Maj(9)	00010110	16	22	7(9)
00000101	05	5	Maj7(9)	00010111	17	23	7(#11)
00000110	06	6	Maj6(9)	00011000	18	24	7(13)
00000111	07	7	aug	00011001	19	25	7(b9)
00001000	08	8	min	00011010	1A	26	7(b13)
00001001	09	9	min6	00011011	1B	27	7(#9)
00001010	0A	10	min7	00011100	1C	28	Maj7aug
00001011	0B	11	min7b5	00011101	1D	29	7aug
00001100	0C	12	min(9)	00011110	1E	30	1+8
00001101	0D	13	min7(9)	00011111	1F	31	1+5
00001110	0E	14	min7(11)	00100000	20	32	sus4
00001111	0F	15	minMaj7	00100001	21	33	1+2+5
00010000	10	16	minMaj7(9)	00100010	22	34	cc
00010001	11	17	dim				

bn On Bass Note Same as Chord root, 127:No bass chord

bt Bass Chord Same as Chord type 127:No bass chord

## (3-6-1-4) CHORD CONTROL type2 (Receive Only)

binary	hexadecimal	
11110000	F0	Exclusive status
01000011	43	YAMAHA ID
01111110	7E	Style
00000011	03	type 2
0ddddddd	dd	note1
0ddddddd	dd	note2
0ddddddd	dd	note3
0ddddddd	dd	...note10
11111110	F7	End of Exclusive

Variable length note data (up to 10) when (Type 2).

Note data exchanged with MIDI note when (Type 2).

## (3-6-1-5) INTERNAL CLOCK/EXTERNAL CLOCK(Receive only)

binary	hexadecimal	
11110000	F0	Exclusive status
01000011	43	YAMAHA
01110011	73	CLAVINOVA
00000001	01	Model ID (Clavinova common ID)
0000nnnn	0N	Clock Substatus (N=2: INTERNAL, N=3: EXTERNAL)
11110111	F7	End of Exclusive

FAH(Start)/FCH(Stop) not received when the internal clock is selected.

## (3-6-1-6) BULK DUMP ORGAN FLUTE DATA

binary	hexadecimal	
11110000	F0	Exclusive status
01000011	43	YAMAHA
01110011	73	CLAVINOVA ID
00000001	01	Model ID (Clavinova common ID)
00000110	06	Bulk ID
0kkkkkkk	kk	Bulk No.(0BH: ORGAN FLUTE DATA)
0000nnnn	0n	Data Length
0000nnnn	0n	Data Length
0000nnnn	0n	Data Length
0000nnnn	0n	Data Length (Data Length=nnnnH bytes)
0ddddddd	dd1	Bulk Data
:	:	:
0ccccc	cc	don't care
11110111	F7	End of Exclusive

Data Length = 16Hbytes

[BULK DATA items dd1...dd22]

1st	OnH	n: MIDI Channel No.	Discription
2nd	Drawber	[1'] 00 - 07H	0: -∞ [dB]
3rd		[1 1/3'] 00 - 07H	1: -12 [dB]
4th		don't care 00H	2: -9 [dB]
5th		[2'] 00 - 07H	3: -6 [dB]
6th		[2 2/3'] 00 - 07H	4: -4.5 [dB]
7th		[4'] 00 - 07H	5: -3 [dB]
8th		[5 1/3'] 00 - 07H	6: -1.5 [dB]
9th		[8'] 00 - 07H	7: 0 [dB]
10th		[16'] 00 - 07H	
11th		[Attack 2'] 00 - 07H	
12th		[Attack 2 2/3'] 00 - 07H	
13th		[Attack 4'] 00 - 07H	
14th	Settings	[Attack Length] 00 - 07H	
15th		[Response] 00 - 07H	
16th		[Attack Mode] 00 - 01H	00H: Each, 01H: First
17th		[Wave Variation] 00 - 01H	00H: Sine, 01H: Tone Wheel
18th		[Volume] 00H:	Volume Max
		01 - 08H	Volume value
19th		don't care 00H	
20th		don't care 00H	
21th		don't care 00H	
22th		don't care 00H	

## (3-6-1-7) DOC MULTI TIMBRE ON/OFF (Receive Only)

binary	hexadecimal	
11110000	F0	Exclusive status
01000011	43	YAMAHA
01110011	73	CLAVINOVA
00000001	01	Model ID (Clavinova common ID)
0001nnnn	1N	Clock Substatus (N=3: OFF, N=4: ON)
11110111	F7	End of Exclusive

## (3-6-2) UNIVERSAL SYSTEM EXCLUSIVE

### (3-6-2-1) UNIVERSAL REALTIME MESSAGE

#### (3-6-2-1-1) MIDI MASTER VOLUME (Receive only)

binary	hexadecimal	
11110000	F0	Exclusive status
01111110	7F	Universal Realtime
01111111	7F	ID of target Device
00001001	04	Sub-ID #1=Device Control Message
00000001	01	Sub-ID #2=Master Volume
0sssssss	SS	Volume LSB
0ttttttt	TT	Volume MSB
11110111	F7	End of Exclusive
or		
11110000	F0	Exclusive status
01111110	7F	Universal Realtime
0xxxxnnn	XN	When N is received N=0-F, whichever is received. When N is transmitted N always=0. X = don't care

00001001	04	Sub-ID #1=Device Control Message
00000001	01	Sub-ID #2=Master Volume
0sssssss	SS	Volume LSB
0ttttttt	TT	Volume MSB
11110111	F7	End of Exclusive

The volume for all channels will be changed simultaneously.  
The TT value is used as the MIDI Master Volume value. (the ss value is ignored.)

### (3-6-2-2) UNIVERSAL NON REALTIME MESSAGE

#### (3-6-2-2-1) GENERAL MIDI SYSTEM ON

binary	hexadecimal	
11110000	F0	Exclusive status
01111110	7E	Universal Non-Realtime
01111111	7F	ID of target Device
00001001	09	Sub-ID #1=General MIDI Message
00000001	01	Sub-ID #2=General MIDI On
11110111	F7	End of Exclusive
or		
11110000	F0	Exclusive status
01111110	7E	Universal Non-Realtime
0xxxxxxx	XN	When N is received N=0-F, whichever is received. When N is transmitted N always=0. X = don't care
00001001	09	Sub-ID #1=General MIDI Message
00000001	01	Sub-ID #2=General MIDI On
11110111	F7	End of Exclusive

Depending upon the received ON message, the SYSTEM MODE will be changed to XG.  
Except MIDI Master Tuning, all control data be reset to default values.  
This message requires approximately 50ms to execute, so sufficient time should be allowed before the next message is sent.

### (3-6-3) XG STANDARD

#### (3-6-3-1) XG PARAMETER CHANGE

##### (3-6-3-1-1) XG SYSTEM ON

binary	hexadecimal	
11110000	F0	Exclusive status
01000011	43	YAMAHA ID
0001nnnn	1N	Device Number (When N is received N=0-F, whichever is received. When N is transmitted N always=0.)
01001100	4C	Model ID
00000000	00	Address High
00000000	00	Address Mid
01111110	7E	Address Low
00000000	00	Data
11110111	F7	End of Exclusive

Depending upon the received ON message, the SYSTEM MODE will be changed to XG. Controllers will be reset, all values of Multi Part and Effect, and All System values denoted by "XG" data within All System will be reset to default values in the table.  
This message requires approximately 50ms to execute, so sufficient time should be allowed before the next message is sent.

##### (3-6-3-1-2) XG PARAMETER CHANGE

binary	hexadecimal	
11110000	F0	Exclusive status
01000011	43	YAMAHA ID
0001nnnn	1N	Device Number (When N is received N=0-F, whichever is received. When N is transmitted N always=0.)
01001100	4C	Model ID
0aaaaaaaa	AA	Address High
0aaaaaaaa	AA	Address Mid
0aaaaaaaa	AA	Address Low
0ddddddd	DD	Data
11110111	F7	End of Exclusive

For parameters with data size of 2 or 4, transmit the appropriate number of data bytes.  
For more information on Address and Parameters, refer to < Table 1-2 > ~ < Table 1-10 > (pages 183-188).

The 9 data types listed below are transmitted and received.

(These are transmitted only after a Parameter change request is received.)

- 1) XG System on
- 2) XG System parameter change
- 3) XG Multi Effect1 parameter change
- 4) XG Multi EQ parameter change
- 5) XG Multi Effect2 parameter change
- 6) XG Special Effect parameter change
- 7) XG Multi Part parameter change
- 8) XG A/D Part parameter change
- 9) XG Drum Setup parameter change

#### (3-6-3-2) XG BULK DUMP

binary	hexadecimal	
11110000	F0	Exclusive status
01000011	43	YAMAHA ID
0000nnnn	0N	Device Number (When N is received N=0-F, whichever is received. When N is transmitted N always=0.)
01001100	4C	Model ID
0bbbbbbb	BB	ByteCount
0bbbbbbb	BB	ByteCount
0aaaaaaaa	AA	Address High
0aaaaaaaa	AA	Address Mid
0aaaaaaaa	AA	Address Low
0ddddddd	DD	Data
0ccccccc	CC	Check sum
11110111	F7	End of Exclusive

For more information on Address and Byte Count, refer to < Table 1-2 > ~ < Table 1-10 > (pages 183-188).

The Check Sum value is set such that the sum of Byte Count, Address, Data, and Check Sum has value zero in its seven least significant bits.  
If the top of the block is appointed to the Address the XG Bulk Dump, Bulk Request will be received.

The Block is a unit that consists of the data, arranged in the list, as the Total Size.

The 9 data types listed below are transmitted and received.  
(These are transmitted only after a Bulk Dump request is received.)

- 2) XG System bulk dump
- 3) XG System Information bulk dump
- 4) XG Multi Effect1 bulk dump
- 5) XG Multi EQ bulk dump
- 6) XG Multi Effect2 bulk dump
- 7) XG Special Effect bulk dump
- 8) XG Multi Part bulk dump
- 9) XG A/D Part bulk dump
- 10) XG Drum Setup bulk dump

#### (3-6-3-3) XG PARAMETER REQUEST (Receive only)

binary	hexadecimal	
11110000	F0	Exclusive status
01000011	43	YAMAHA ID
0011nnnn	3n	Device Number (When N is received N=0-F, whichever is received.)
01001100	4C	Model ID
0aaaaaaaa	AA	Address High
0aaaaaaaa	AA	Address Mid
0aaaaaaaa	AA	Address Low
11110111	F7	End of Exclusive

For more information on Address and Byte Count refer to < Table 1-2 > ~ < Table 1-10 > (pages 183-188).

The 8 data types listed below are received.

- 1) XG System parameter
  - 2) XG Multi Effect1 parameter
  - 3) XG Multi EQ parameter
  - 4) XG Multi Effect2 parameter
  - 5) XG Special Effect parameter
  - 6) XG Multi Part parameter \*
  - 7) XG A/D Part parameter
  - 8) XG Drum Setup parameter
- \* MIDI Receive Mode only effective in XG/GM mode.

#### (3-6-3-4) XG DUMP REQUEST (Receive only)

binary	hexadecimal	
11110000	F0	Exclusive status
01000011	43	YAMAHA ID
0010nnnn	2n	Device Number (When N is received N=0-F, whichever is received.)
01001100	4C	Model ID
0aaaaaaaa	AA	Address High
0aaaaaaaa	AA	Address Mid
0aaaaaaaa	AA	Address Low
11110111	F7	End of Exclusive

For more information on Address and Byte Count refer to < Table 1-2 > ~ < Table 1-10 > (pages 183-188).

The 9 data types listed below are received.

- 1) XG System block
  - 2) XG System Information block
  - 3) XG Multi Effect1 block
  - 4) XG Multi EQ block
  - 5) XG Multi Effect2 block
  - 6) XG Special Effect block
  - 7) XG Multi Part block \*
  - 8) XG A/D Part block
  - 9) XG Drum Setup block
- \* MIDI Receive Mode only effective in XG/GM mode.

## (3-6-4) SPECIAL OPERATORS

### (3-6-4-1) VOLUME ,EXPRESSION AND PAN REALTIME CONTROL OFF

binary	hexadecimal	
11110000	F0	Exclusive status
01000011	43	YAMAHA ID
01110011	73	Clavinova ID
00000001	01	Model ID(Clavinova common ID)
00010001	11	Sub ID
0000nnnn	0n	n: Channel No.(00H-0FH)
01001001	45	Volume and Expression Realtime Control Off
0vvvvvvv	VV	Value VV: off=7FH, on=00H
11110111	F7	End of Exclusive

When "On" is received, subsequent volume, expression, and PAN changes are only valid after the reception of the next key on. Normal operation resumes when "Off" is received.

### (3-6-4-2) GLIDE Switch On/Off

binary	hexadecimal	
11110000	F0	Exclusive status
01000011	43	YAMAHA
01110011	73	CLAVINOVA
00000001	01	Model ID(Clavinova common ID)
00010001	11	Sub ID
0000nnnn	0n	n: Channel No.(00H-0FH)
01010001	51	Pedal Switch Assignable Controller Control No.
00000000	00	Glide Switch
0sssssss	ss	Switch On/Off
		00H: Switch Off
		7FH: Switch On
11110111	F7	End of Exclusive

Operation is the same as when the GLIDE switch assigned to the pedal switch is operated. (Pedal Switch Assignable Controllers)

### (3-6-4-3) Vocal Harmony Pitch to Note (Receive Only)

binary	hexadecimal	
11110000	F0	Exclusive status
01000011	43	YAMAHA
01110011	73	CLAVINOVA
00000001	01	Model ID(Clavinova common ID)
00010001	11	Sub ID
00000000	00	Channel No.(always 00)
01010000	50	Vocal Harmony Additional Parameter Control No.
00000000	00	Pitch to Note Parameter No.
0sssssss	ss	Pitch To Note Switch
		00H: Off
		01H: On
11110111	F7	End of Exclusive

Turns the function which derives note on, note off, and pitch data from the input voice signal and outputs the specified note group on or off.

### (3-6-4-4) Vocal Harmony Pitch to Note Part (Receive Only)

binary	hexadecimal	
11110000	F0	Exclusive status
01000011	43	YAMAHA
01110011	73	CLAVINOVA
00000001	01	Model ID(Clavinova common ID)
00010001	11	Sub ID
00000000	00	Channel No.(always 00)
01010000	50	Vocal Harmony Additional Parameter Control No.
00000001	01	Pitch to Note Part Parameter No.
0sssssss	ss	Pitch To Note Part No.
		00H: RIGHT1
		01H: RIGHT2
		02H: LEFT
		03H: LEAD
		04H: UPPER
11110111	F7	End of Exclusive

Specifies the above note group.

### (3-6-4-5) Vocal Harmony Vocoder Part (Harmony Part(Panel)) (Receive Only)

binary	hexadecimal	
11110000	F0	Exclusive status
01000011	43	YAMAHA
01110011	73	CLAVINOVA
00000001	01	Model ID(Clavinova common ID)
00010001	11	Sub ID
00000000	00	Channel No.(always 00)
01010000	50	Vocal Harmony Additional Parameter Control No.
00010000	10	Vocoder Part Parameter No.
0sssssss	ss	Harmony Part No.
		00H: Off
		01H: Upper
		02H: Lower
11110111	F7	End of Exclusive

Specifies the keyboard to control the harmony notes in the Vocoder mode.

### (3-6-4-6) Vocal Harmony Additional Reverb Depth (Receive Only)

binary	hexadecimal	
11110000	F0	Exclusive status
01000011	43	YAMAHA
01110011	73	CLAVINOVA
00000001	01	Model ID(Clavinova common ID)
00010001	11	Sub ID
00000000	00	Channel No.(always 00)
01010000	50	Vocal Harmony Additional Parameter Control No.
00010001	11	Vocal Harmony Additional Reverb Depth Parameter No.
0sssssss	ss	Value(0...7FH)
11110111	F7	End of Exclusive

Adjusts the reverb applied only to the harmony sound.

### (3-6-4-7) Vocal Harmony Additional Chorus Depth (Receive Only)

binary	hexadecimal	
11110000	F0	Exclusive status
01000011	43	YAMAHA
01110011	73	CLAVINOVA
00000001	01	Model ID(Clavinova common ID)
00010001	11	Sub ID
00000000	00	Channel No.(always 00)
01010000	50	Vocal Harmony Additional Parameter Control No.
00010010	12	Vocal Harmony Additional Chorus Depth Parameter No.
0sssssss	ss	Value(0...7FH)
11110111	F7	End of Exclusive

Adjusts the chorus applied only to the harmony sound.

## (3-6-5) Others

### (3-6-5-1) MIDI MASTER TUNING (Receive only)

binary	hexadecimal	
11110000	F0	Exclusive status
01000011	43	YAMAHA ID
0001nnnn	1N	When N is received N=0-F, whichever is received.
00100111	27	Model ID
00110000	30	Sub ID
00000000	00	
00000000	00	
0mmmmmmm	MM	Master Tune MSB
0lllllll	LL	Master Tune LSB
0ccccccc	CC	don't care
11110111	F7	End of Exclusive

Changes tuning of all channels.

MM, LL values are used to define the MIDI Master Tuning value.

T = M-128

T : Tuning value (-100cent - +100cent)

M : A single byte value (28-228) consists of bytes 0-3 of MM = MSB, bytes 0-3 of LL = LSB.

In this setting, GM System ON, XG System ON will not be reset.

< Table 1-1 > Parmeter Basic Address

	Parameter Change Address			Description
	(H)	(M)	(L)	
SYSTEM	00	00	00	System
	00	00	7D	Drum Setup Reset
	00	00	7E	XG System On
	00	00	7F	All Parameter Reset
INFORMATION	01	00	00	System Information
EFFECT 1	02	01	00	Effect1(Reverb,Chorus,Variation)
MULTI EQ	02	40	00	Multi EQ
EFFECT 2	03	00	00	Effect2 (Insertion Effect 1)
	:	:	:	:
	03	03	00	(Insertion Effect 4)
SPECIAL EFFECT	04	00	00	Special Insertion Effect 1
MULTI PART	08	00	00	Multi Part 1
	:	:	:	:
	08	0F	00	Multi Part 16
A/D PART	10	00	00	A/D Part 1
DRUM	30	0D	00	Drum Setup 1
	31	0D	00	Drum Setup 2
				Address
				Parameter
				:
				3n 0D 00 note number 13
				3n 0E 00 note number 14
				:
				3n 5B 00 note number 91

< Table 1-2 > MIDI Parameter Change table ( SYSTEM )

Address (H)	Size (H)	Data (H)	Parameter Name	Description	Default Value(H)
00 00 00	4	0000	Master Tune	-102.4..+102.3[cent]	00 04 00 00
01		..07FF		1st bit3-0 -> bit15-12	(0400)
02				2nd bit3-0 -> bit11-8	
03				3rd bit3-0 -> bit7-4	
				4th bit3-0 -> bit3-0	
04	1	00..7F	Master Volume	0..127	7F
05	1		Not Used		
06	1	28..58	Transpose	-24..+24[semitones]	40
7D		n	Drum Setup Reset	n=Drum Setup Number	
7E		00	XG System On	00=XG Sytem on	
7F		00	All Parameter Reset	00=on (receive only)	
TOTAL SIZE	7				

< Table 1-3 > MIDI Parameter Change table ( System information )

Address (H)	Size (H)	Data (H)	Parameter Name	Description
01 00 00	E	20..7F	Model Name 1	32..127(ASCII)
:	:	:		
0D		20..7F	Model Name 14	32..127(ASCII)
0E	1	00		
0F	1	00		
TOTAL SIZE	10			

(Transmitted by Dump Request. Not received. Bulk Dump Only)

< Table 1-4 > MIDI Parameter Change table (EFFECT 1)

Address (H)	Size (H)	Data (H)	Parameter Name	Description	Default Value(H)
02 01 00	2	00..7F	Reverb Type MSB	Refer to the Ef. Type List	01 (=HALL1) *1
		00..7F	Reverb Type LSB	00 : basic type	00 *1
	02	00..7F	Reverb Parameter 1	Refer to the Ef. Parameter List	Depend on Reverb type
	03	00..7F	Reverb Parameter 2	Refer to the Ef. Parameter List	Depend on Reverb type
	04	00..7F	Reverb Parameter 3	Refer to the Ef. Parameter List	Depend on Reverb type
	05	00..7F	Reverb Parameter 4	Refer to the Ef. Parameter List	Depend on Reverb type
	06	00..7F	Reverb Parameter 5	Refer to the Ef. Parameter List	Depend on Reverb type
	07	00..7F	Reverb Parameter 6	Refer to the Ef. Parameter List	Depend on Reverb type
	08	00..7F	Reverb Parameter 7	Refer to the Ef. Parameter List	Depend on Reverb type
	09	00..7F	Reverb Parameter 8	Refer to the Ef. Parameter List	Depend on Reverb type
	0A	00..7F	Reverb Parameter 9	Refer to the Ef. Parameter List	Depend on Reverb type
	0B	00..7F	Reverb Parameter 10	Refer to the Ef. Parameter List	Depend on Reverb type
	0C	00..7F	Reverb Return	-∞..0..+6dB(0.96..127)	40 *2
	0D	01..7F	Reverb Pan	L63..C..R63(1..64..127)	40 *2
TOTAL SIZE			0E		

\*1 The default Reverb Type is selected when an XG System On message is received. When the power is turned on the Reverb Type will depend on the selected style.

\*2 When the power is turned on the value will depend on the selected style.

02 01 10	1	00..7F	Reverb Parameter 11	Refer to the Ef. Parameter List	Depend on Reverb type
	11	00..7F	Reverb Parameter 12	Refer to the Ef. Parameter List	Depend on Reverb type
	12	00..7F	Reverb Parameter 13	Refer to the Ef. Parameter List	Depend on Reverb type
	13	00..7F	Reverb Parameter 14	Refer to the Ef. Parameter List	Depend on Reverb type
	14	00..7F	Reverb Parameter 15	Refer to the Ef. Parameter List	Depend on Reverb type
	15	00..7F	Reverb Parameter 16	Refer to the Ef. Parameter List	Depend on Reverb type
TOTAL SIZE			6		

02 01 20	2	00..7F	Chorus Type MSB	Refer to the Ef. Type List	41 (=CHORUS1) *3
		00..7F	Chorus Type LSB	00 : basic type	00 *3
	22	00..7F	Chorus Parameter 1	Refer to the Ef. Parameter List	Depend on Chorus Type
	23	00..7F	Chorus Parameter 2	Refer to the Ef. Parameter List	Depend on Chorus Type
	24	00..7F	Chorus Parameter 3	Refer to the Ef. Parameter List	Depend on Chorus Type
	25	00..7F	Chorus Parameter 4	Refer to the Ef. Parameter List	Depend on Chorus Type
	26	00..7F	Chorus Parameter 5	Refer to the Ef. Parameter List	Depend on Chorus Type
	27	00..7F	Chorus Parameter 6	Refer to the Ef. Parameter List	Depend on Chorus Type
	28	00..7F	Chorus Parameter 7	Refer to the Ef. Parameter List	Depend on Chorus Type
	29	00..7F	Chorus Parameter 8	Refer to the Ef. Parameter List	Depend on Chorus Type
	2A	00..7F	Chorus Parameter 9	Refer to the Ef. Parameter List	Depend on Chorus Type
	2B	00..7F	Chorus Parameter 10	Refer to the Ef. Parameter List	Depend on Chorus Type
	2C	00..7F	Chorus Return	-∞..0..+6dB(0.96..127)	40 *2
	2D	01..7F	Chorus Pan	L63..C..R63(1..64..127)	40 *2
	2E	00..7F	Send Chorus To Reverb	-∞..0..+6dB(0.96..127)	00 *2
TOTAL SIZE			0F		

\*3 The default Chorus Type is selected when an XG System On message is received. When the power is turned on the Chorus Type will depend on the selected style.

02 01 30	1	00..7F	Chorus Parameter 11	Refer to the Ef. Parameter List	Depend on Chorus Type
	31	00..7F	Chorus Parameter 12	Refer to the Ef. Parameter List	Depend on Chorus Type
	32	00..7F	Chorus Parameter 13	Refer to the Ef. Parameter List	Depend on Chorus Type
	33	00..7F	Chorus Parameter 14	Refer to the Ef. Parameter List	Depend on Chorus Type
	34	00..7F	Chorus Parameter 15	Refer to the Ef. Parameter List	Depend on Chorus Type
	35	00..7F	Chorus Parameter 16	Refer to the Ef. Parameter List	Depend on Chorus Type
TOTAL SIZE			6		

02 01 40	2	00..7F	Variation Type MSB	Refer to the Ef. Type List	05 (=DELAY L,C,R) *4
		00..7F	Variation Type LSB	00 : basic type	00 *4
	42	00..7F	Vari. Param. 1 MSB	Refer to the Ef. Parameter List	Depend on Vari. Type
		00..7F	Vari. Param. 1 LSB	Refer to the Ef. Parameter List	Depend on Vari. Type
	44	00..7F	Vari. Param. 2 MSB	Refer to the Ef. Parameter List	Depend on Vari. Type
		00..7F	Vari. Param. 2 LSB	Refer to the Ef. Parameter List	Depend on Vari. Type
	46	00..7F	Vari. Param. 3 MSB	Refer to the Ef. Parameter List	Depend on Vari. Type
		00..7F	Vari. Param. 3 LSB	Refer to the Ef. Parameter List	Depend on Vari. Type
	48	00..7F	Vari. Param. 4 MSB	Refer to the Ef. Parameter List	Depend on Vari. Type
		00..7F	Vari. Param. 4 LSB	Refer to the Ef. Parameter List	Depend on Vari. Type
	4A	00..7F	Vari. Param. 5 MSB	Refer to the Ef. Parameter List	Depend on Vari. Type
		00..7F	Vari. Param. 5 LSB	Refer to the Ef. Parameter List	Depend on Vari. Type
	4C	00..7F	Vari. Param. 6 MSB	Refer to the Ef. Parameter List	Depend on Vari. Type
		00..7F	Vari. Param. 6 LSB	Refer to the Ef. Parameter List	Depend on Vari. Type
	4E	00..7F	Vari. Param. 7 MSB	Refer to the Ef. Parameter List	Depend on Vari. Type
		00..7F	Vari. Param. 7 LSB	Refer to the Ef. Parameter List	Depend on Vari. Type
	50	00..7F	Vari. Param. 8 MSB	Refer to the Ef. Parameter List	Depend on Vari. Type
		00..7F	Vari. Param. 8 LSB	Refer to the Ef. Parameter List	Depend on Vari. Type
	52	00..7F	Vari. Param. 9 MSB	Refer to the Ef. Parameter List	Depend on Vari. Type
		00..7F	Vari. Param. 9 LSB	Refer to the Ef. Parameter List	Depend on Vari. Type
	54	00..7F	Vari. Param. 10 MSB	Refer to the Ef. Parameter List	Depend on Vari. Type
		00..7F	Vari. Param. 10 LSB	Refer to the Ef. Parameter List	Depend on Vari. Type
	56	00..7F	Variation Return	-∞..0..+6dB(0.96..127)	40 *2
	57	01..7F	Variation Pan	L63..C..R63(1..64..127)	40 *2



Address (H)	Size (H)	Data (H)	Parameter Name	Description	Default Value(H)
58	1	00..7F	Send Vari. To Reverb	-∞..0..+6dB(0..96..127)	00 *2
59	1	00..7F	Send Vari. To Chorus	-∞..0..+6dB(0..96..127)	00 *2
5A	1	00..01	Variation Connection	0:insertion,1:system	00 *2
5B	1	00..1F	Variation Part	Part1..16(0..15) AD1(64) OFF(16..63, 65..127)	7F *2
5C	1	01..7F	MW Vari. Ctrl Depth	-63..+63	40
5D	1	01..7F	PB Vari. Ctrl Depth	-63..+63	40
5E	1	01..7F	CAT Vari. Ctrl Depth	-63..+63	40
5F	1		Not Used		
60	1		Not Used		
TOTAL SIZE	21				

\*4 The default Variation Type is selected when an XG System On message is received. When the power is turned on the Variation Type will depend on the selected style.

02	01	70	1	00..7F	Variation Parameter 11	option Parameter	Depend on Variation Type
		71	1	00..7F	Variation Parameter 12	option Parameter	Depend on Variation Type
		72	1	00..7F	Variation Parameter 13	option Parameter	Depend on Variation Type
		73	1	00..7F	Variation Parameter 14	option Parameter	Depend on Variation Type
		74	1	00..7F	Variation Parameter 15	option Parameter	Depend on Variation Type
		75	1	00..7F	Variation Parameter 16	option Parameter	Depend on Variation Type
TOTAL SIZE			6				

### < Table 1-5 > MIDI Parameter Change table ( MULTI EQ )

Address (H)	Size (H)	Data (H)	Parameter Name	Description	Default Value(H)		
02	40	00	1	34..4C	EQ Type	0:FLAT 1:JAZZ 2:POPS 3:ROCK 4:CLASSIC	0 *5
		01	1	34..4C	EQ Gain1	-12..+12[dB]	40
		02	1	04..28	EQ Frequency1	32..2000[Hz]	0C
		03	1	01..78	EQ Q1	0.1..12.0	07
		04	1	00..01	EQ Shape1	00:Shelving,01:Peaking	00
		05	1	34..4C	EQ Gain2	-12..+12[dB]	40
		06	1	0E..36	EQ Frequency2	0.1..10[KHz]	1C
		07	1	01..78	EQ Q2	0.1..12.0	07
		08	1		Not Used		
		09	1	34..4C	EQ Gain3	-12..+12[dB]	40
		0A	1	0E..36	EQ Frequency3	0.1..10[KHz]	22
		0B	1	01..78	EQ Q3	0.1..12.0	07
		0C	1		Not Used		
		0D	1	34..4C	EQ Gain4	-12..+12[dB]	40
		0E	1	0E..36	EQ Frequency4	0.1..10[KHz]	2E
		0F	1	01..78	EQ Q4	0.1..12.0	07
		10	1		Not Used		
		11	1	34..4C	EQ Gain5	-12..+12[dB]	40
		12	1	1C..3A	EQ Frequency5	0.5..16.0[KHz]	3C
		13	1	01..78	EQ Q5	0.1..12.0	07
		14	1	00..01	EQ Shape5	00:Shelving,01:Peaking	00
TOTAL SIZE			15				

\*5 When the power is turned on the default is Preset 1 in the Full Mixing Console Master EQ display.

### < Table 1-6 > MIDI Parameter Change table (EFFECT2)

Address (H)	Size (H)	Data (H)	Parameter Name	Description		
03	0n	00	2	00..7F	Insertion Type MSB	Refer to the Ef. Type List
				00..7F	Insertion Type LSB	
		02	1	00..7F	Insertion Parameter1	Refer to the Ef. Parameter List
		03	1	00..7F	Insertion Parameter2	Refer to the Ef. Parameter List
		04	1	00..7F	Insertion Parameter3	Refer to the Ef. Parameter List
		05	1	00..7F	Insertion Parameter4	Refer to the Ef. Parameter List
		06	1	00..7F	Insertion Parameter5	Refer to the Ef. Parameter List
		07	1	00..7F	Insertion Parameter6	Refer to the Ef. Parameter List
		08	1	00..7F	Insertion Parameter7	Refer to the Ef. Parameter List
		09	1	00..7F	Insertion Parameter8	Refer to the Ef. Parameter List
		0A	1	00..7F	Insertion Parameter9	Refer to the Ef. Parameter List
		0B	1	00..7F	Insertion Parameter10	Refer to the Ef. Parameter List
		0C	1	00..7F	Insertion Part	Part1..16(0..15) AD1(64) OFF(16..63, 65..127)
		0D	1	00..7F	MW INS CTRL DPT	
		0E	1	00..7F	BEND INS CTRL DPT	
		0F	1	00..7F	CAT INS CTRL DPT	
		10	1	00..7F	Not Used	
		11	1	00..7F	Not Used	
TOTAL SIZE			12			

# MIDI Data Format

Address (H)	Size	Data (H)	Parameter Name	Description	
03 0n	20	1	00..7F	Insertion Parameter11	Refer to the Ef. Parameter List
	21	1	00..7F	Insertion Parameter12	Refer to the Ef. Parameter List
	22	1	00..7F	Insertion Parameter13	Refer to the Ef. Parameter List
	23	1	00..7F	Insertion Parameter14	Refer to the Ef. Parameter List
	24	1	00..7F	Insertion Parameter15	Refer to the Ef. Parameter List
	25	1	00..7F	Insertion Parameter16	Refer to the Ef. Parameter List
TOTAL SIZE	06				
03 0n	30	2	00..7F	Ins. Param.1 MSB	Refer to the Ef. Parameter List
			00..7F	Ins. Param.1 LSB	Refer to the Ef. Parameter List
03 0n	32	2	00..7F	Ins. Param.2 MSB	Refer to the Ef. Parameter List
			00..7F	Ins. Param.2 LSB	Refer to the Ef. Parameter List
03 0n	34	2	00..7F	Ins. Param.3 MSB	Refer to the Ef. Parameter List
			00..7F	Ins. Param.3 LSB	Refer to the Ef. Parameter List
03 0n	36	2	00..7F	Ins. Param.4 MSB	Refer to the Ef. Parameter List
			00..7F	Ins. Param.4 LSB	Refer to the Ef. Parameter List
03 0n	38	2	00..7F	Ins. Param.5 MSB	Refer to the Ef. Parameter List
			00..7F	Ins. Param.5 LSB	Refer to the Ef. Parameter List
03 0n	3A	2	00..7F	Ins. Param.6 MSB	Refer to the Ef. Parameter List
			00..7F	Ins. Param.6 LSB	Refer to the Ef. Parameter List
03 0n	3C	2	00..7F	Ins. Param.7 MSB	Refer to the Ef. Parameter List
			00..7F	Ins. Param.7 LSB	Refer to the Ef. Parameter List
03 0n	3E	2	00..7F	Ins. Param.8 MSB	Refer to the Ef. Parameter List
			00..7F	Ins. Param.8 LSB	Refer to the Ef. Parameter List
03 0n	40	2	00..7F	Ins. Param.9 MSB	Refer to the Ef. Parameter List
			00..7F	Ins. Param.9 LSB	Refer to the Ef. Parameter List
03 0n	42	2	00..7F	Ins. Param.10 MSB	Refer to the Ef. Parameter List
			00..7F	Ins. Param.10 LSB	Refer to the Ef. Parameter List
TOTAL SIZE	14				

For effect types that do not require MSB, the Parameters for Address 02-0B will be received. Address 30-42 will not be received.

For effect types that require MSB, the Parameters for Address 30-42 will be received. Address 02-0B will not be received.

When Bulk Dumps that include Effect Type data are transmitted, the Parameters for Address 02 - 0B will always be transmitted. But, effects that require MSB, when the bulk dump is received the Parameters for Address 02 - 0B will not be received.

n=Insertion Effect No.(0-3)

## < Table 1-7 > MIDI Parameter Change table (SPECIAL EFFECT)

Address (H)	Size	Data (H)	Parameter	Description	Default Value(H)
04 00	00	2	00 - 7F	Unique Insertion Effect Type MSB	90(=Chordal)
			00 - 7F	Unique Insertion Effect Type LSB	23(=MenChoir)
	02	1	00 - 7F	Unique Insertion Effect Parameter1	Depends on insertion 1 type
	03	1	00 - 7F	Unique Insertion Effect Parameter2	Depends on insertion 1 type
	04	1	00 - 7F	Unique Insertion Effect Parameter3	Depends on insertion 1 type
	05	1	00 - 7F	Unique Insertion Effect Parameter4	Depends on insertion 1 type
	06	1	00 - 7F	Unique Insertion Effect Parameter5	Depends on insertion 1 type
	07	1	00 - 7F	Unique Insertion Effect Parameter6	Depends on insertion 1 type
	08	1	00 - 7F	Unique Insertion Effect Parameter7	Depends on insertion 1 type
	09	1	00 - 7F	Unique Insertion Effect Parameter8	Depends on insertion 1 type
	0A	1	00 - 7F	Unique Insertion Effect Parameter9	Depends on insertion 1 type
	0B	1	00 - 7F	Unique Insertion Effect Parameter10	Depends on insertion 1 type
	0C	1	00 - 7F	Unique Insertion Effect Part	AD1(64)
				OFF(0...63, 65...127)	
	0D	1	00 - 7F	Not Used	
	:		:		
	11	1	00 - 7F	Not Used	
TOTAL SIZE	12				
04 00	14	1	00 - 7F	Unique Insertion Effect External Control Ch1(Harmony Channel)	127
	15	1	00 - 7F	Unique Insertion Effect External Control Ch2(Melody Channel)	127
TOTAL SIZE	2				
04 00	20	1	00 - 7F	Unique Insertion Effect Parameter11	Depends on insertion 1 type
	21	1	00 - 7F	Unique Insertion Effect Parameter12	Depends on insertion 1 type
	22	1	00 - 7F	Unique Insertion Effect Parameter13	Depends on insertion 1 type
	23	1	00 - 7F	Unique Insertion Effect Parameter14	Depends on insertion 1 type
	24	1	00 - 7F	Unique Insertion Effect Parameter15	Depends on insertion 1 type
	25	1	00 - 7F	Unique Insertion Effect Parameter16	Depends on insertion 1 type
TOTAL SIZE	6				

## < Table 1-8 > MIDI Parameter Change table (MULTI PART)

Address (H)	Size	Data (H)	Parameter Name	Description	Default Value(H)
08 nn	00	1	00..20	Element Reserve	0(Part10),2(Others)
	nn	01	00..7F	Bank Select MSB	7F(Part10),00(Others)
	nn	02	00..7F	Bank Select LSB	00

Address (H)	Size (H)	Data (H)	Parameter	Description	Default Value(H)
nn 03	1	00..7F	Program Number	1..128	00
nn 04	1	00..0F, 7F	Rcv Channel	A1..A16, OFF	Part No.
nn 05	1	00..01	Mono/Poly Mode	0:mono,1:poly	01
nn 06	1	00..02	Same Note Number Key On Assign	0:single 1:multi 2:inst (for DRUM)	00
nn 07	1	00..02	Part Mode	0:normal 1:drum, 2..3:drumS1..2	00 (Except Part10) 01 (Part10)
nn 08	1	28..58	Note Shift	-24..+24[semitones]	40
nn 09	2	00..FF	Detune	-12.8..+12.7[Hz]	08 00
nn 0A				1st bit3..0 -> bit7..4 2nd bit3..0 -> bit3..0	(80)
nn 0B	1	00..7F	Volume	0..127	64
nn 0C	1	00..7F	Velocity Sense Depth	0..127	40
nn 0D	1	00..7F	Velocity Sense Offset	0..127	40
nn 0E	1	00..7F	Pan	0:random L63..C..R63(1..64..127)	40
nn 0F	1	00..7F	Note Limit Low	C-2..G8	00
nn 10	1	00..7F	Note Limit High	C-2..G8	7F
nn 11	1	00..7F	Dry Level	0..127	7F
nn 12	1	00..7F	Chorus Send	0..127	00
nn 13	1	00..7F	Reverb Send	0..127	28
nn 14	1	00..7F	Variation Send	0..127	00
nn 15	1	00..7F	Vibrato Rate	-64..+63	40
nn 16	1	00..7F	Vibrato Depth	-64..+63	40
nn 17	1	00..7F	Vibrato Delay	-64..+63	40
nn 18	1	00..7F	Filter Cutoff Freq.	-64..+63	40
nn 19	1	00..7F	Filter Resonance	-64..+63	40
nn 1A	1	00..7F	EG Attack Time	-64..+63	40
nn 1B	1	00..7F	EG Decay Time	-64..+63	40
nn 1C	1	00..7F	EG Release Time	-64..+63	40
nn 1D	1	28..58	MW Pitch Control	-24..+24[semitones]	40
nn 1E	1	00..7F	MW Filter Control	-9600..+9450[cent]	40
nn 1F	1	00..7F	MW Amp. Control	-100..+100[%]	40
nn 20	1	00..7F	MW LFO PMod Depth	0..127	0A
nn 21	1	00..7F	MW LFO FMod Depth	0..127	00
nn 22	1	00..7F	MW LFO AMod Depth	0..127	00
nn 23	1	28..58	Bend Pitch Control	-24..+24[semitones]	42
nn 24	1	00..7F	Bend Filter Control	-9600..+9450[cent]	40
nn 25	1	00..7F	Bend Amp. Control	-100..+100[%]	40
nn 26	1	00..7F	Bend LFO PMod Depth	0..127	00
nn 27	1	00..7F	Bend LFO FMod Depth	0..127	00
nn 28	1	00..7F	Bend LFO AMod Depth	0..127	00
TOTAL SIZE	29				
nn 30	1		Not Used		
:	:		:		
nn 34	1		Not Used		
nn 35	1	00..01	Rcv Note Message	OFF, ON	01
nn 36	1		Not Used		
:	:		:		
nn 40	1		Not Used		
nn 41	1	00..7F	Scale Tuning C	-64..+63[cent]	40
nn 42	1	00..7F	Scale Tuning C#	-64..+63[cent]	40
nn 43	1	00..7F	Scale Tuning D	-64..+63[cent]	40
nn 44	1	00..7F	Scale Tuning D#	-64..+63[cent]	40
nn 45	1	00..7F	Scale Tuning E	-64..+63[cent]	40
nn 46	1	00..7F	Scale Tuning F	-64..+63[cent]	40
nn 47	1	00..7F	Scale Tuning F#	-64..+63[cent]	40
nn 48	1	00..7F	Scale Tuning G	-64..+63[cent]	40
nn 49	1	00..7F	Scale Tuning G#	-64..+63[cent]	40
nn 4A	1	00..7F	Scale Tuning A	-64..+63[cent]	40
nn 4B	1	00..7F	Scale Tuning A#	-64..+63[cent]	40
nn 4C	1	00..7F	Scale Tuning B	-64..+63[cent]	40
nn 4D	1	28..58	CAT Pitch Control	-24..+24[semitones]	40
nn 4E	1	00..7F	CAT Filter Control	-9600..+9450[cent]	40
nn 4F	1	00..7F	CAT Amplitude Control	-100..+100[%]	40
nn 50	1	00..7F	CAT LFO PMod Depth	0..127	00
nn 51	1	00..7F	CAT LFO FMod Depth	0..127	00
nn 52	1	00..7F	CAT LFO AMod Depth	0..127	00
nn 53	1		Not Used		
:	:		:		
nn 66	1		Not Used		
nn 67	1	00..01	Portamento Switch	off/on	00
nn 68	1	00..7F	Portamento Time	0..127	00
nn 69	1		Not Used		
:	:		:		
nn 6E	1		Not Used		
TOTAL SIZE	3F				

Address (H)	Size (H)	Data (H)	Parameter	Description	
08 nn	70	1	Not Used		
	71	1	Not Used		
	72	1	EQ BASS	-64..+63(-12..+12[dB])	40
	73	1	EQ TREBLE	-64..+63(-12..+12[dB])	40
TOTAL SIZE	04				
08 nn	74	1	Not Used		
	75	1	Not Used		
	76	1	EQ BASS frequency	32..2.0k[Hz]	0C
	77	1	EQ TREBLE frequency	500..16.0k[Hz]	36
	78	1	Not Used		
	:	:	:		
	7F	1	Not Used		
TOTAL SIZE	0C				

nn = PartNumber(00..0F)

If there is a Drum Voice assigned to the Part, the following parameters are ineffective.

- Bank Select LSB
- Pitch EG
- Portamento
- Soft Pedal
- Mono/Poly
- Scale Tuning

### <Table 1-9> MIDI Parameter Change table (A/D PART)

Address (H)	Size (H)	Data (H)	Parameter	Description	
10 nn	0	1	Not Used		
	:	:	:		
	3	1	Not Used		
10 nn	4	1	Rev CHANNEL	A1..A16,OFF	
	5	1	Not Used		
	:	:	:		
	0A	1	Not Used		
	0B	1	VOLUME	0..127	
	0C	1	Not Used		
	0D	1	Not Used		
	0E	1	PAN	L63..C..R63(1..64..127)	
	0F	1	Not Used		
	10	1	Not Used		
	11	1	DRY LEVEL	0..127	
	12	1	CHORUS SEND	0..127	
	13	1	REVERB SEND	0..127	
	14	1	VARIATION SEND	0..127	
TOTAL SIZE	15				

nn:A/D Part number(fixed 00)

### < Table 1-10 > MIDI Parameter Change table ( DRUM SETUP )

Address (H)	Size (H)	Data (H)	Parameter Name	Description	Default Value(H)
3n rr	00	1	Pitch Coarse	-64..+63	40
	01	1	Pitch Fine	-64..+63[cent]	40
	02	1	Level	0..127	Depend on the Note
	03	1	Alternate Group	0:off,1..127	Depend on the Note
	04	1	Pan	0:random L63..C..R63(1..64..127)	Depend on the Note
	05	1	Reverb Send Level	0..127	Depend on the Note
	06	1	Chorus Send Level	0..127	Depend on the Note
	07	1	Variation Send Level	0..127	7F
	08	1	Key Assign	0:single,1:multi	00
	09	1	Rev Note Off	off/on	Depend on the Note
	0A	1	Rev Note On	off/on	01
	0B	1	Filter Cutoff Freq.	-64..63	40
	0C	1	Filter Resonance	-64..63	40
	0D	1	EG Attack Rate	-64..63	40
	0E	1	EG Decay1 Rate	-64..63	40
	0F	1	EG Decay2 Rate	-64..63	40
TOTAL SIZE	10				

n:Drum Setup Number(0 - 1)

rr:note number(0DH - 5BH)

If XG SYSTEM ON and/or GM On message is received, all Drum Setup Parameter will be reset to default values.

According to the Drum Setup Reset message, individual Drum Setup Parameters can be reset to default values.

< Table 1-11 > Effect Type List

	XG ESSENTIAL EFFECT(XG required)
	Same as LSB=0
	XG OPTION EFFECT
	PSR8000 Original EFFECT

\* If the received value does not contain an effect type in the TYPE LSB, the LSB will be directed to TYPE 0.  
 \* ( ) is the panel effect name.

**REVERB TYPE**

TYPE MSB	TYPE LSB											
DEC	HEX	00	01	02	03 ... 07	08	09 ... 15	16	17	18	19	20
000	0	NO EFFECT										
001	1	HALL1(Hall1)	HALL2(Hall5)					(Hall2)	(Hall3)	(Hall4)		
002	2	ROOM1(Room5)	ROOM2(Room6)	ROOM3(Room7)				(Room1)	(Room2)	(Room3)	(Room4)	
003	3	STAGE1(Stage3)	STAGE2(Stage4)					(Stage1)	(Stage2)			
004	4	PLATE(Plate3)						(Plate1)	(Plate2)			
005	5	NO EFFECT										
:	:	:										
015	F	NO EFFECT										
016	10	WHITE ROOM(WhiteRoom)										
017	11	TUNNEL(Tunnel)										
018	12	CANYON(Canyon)										
019	13	BASEMENT(Basement)										
020	14	NO EFFECT										
:	:	:										
127	7F	NO EFFECT										

**CHORUS TYPE**

TYPE MSB	TYPE LSB											
DEC	HEX	00	01	02	03 ... 07	08	09 ... 15	16	17	18	19	20
000	0	NO EFFECT										
001	1	NO EFFECT										
:	:	:										
064	40	NO EFFECT										
065	41	CHORUS1(Chorus6)	CHORUS2(Chorus7)	CHORUS3(Chorus5)		CHORUS4(Chorus8)						
066	42	CELESTE1(Celeste1)	CELESTE2(Chorus4)	CELESTE3(Celeste2)		CELESTE4(Chorus2)		(Chorus3)	(Chorus1)			
067	43	FLANGER 1(Flanger5)	FLANGER 2(Flanger4)			FLANGER 3(Flanger1)		(Flanger2)	(Flanger3)			
068	44	SYMPHONIC(Symphonic2)						(Symphonic1)				
069	45	NO EFFECT										
:	:	:										
071	47	NO EFFECT										
072	48	PHASER 1(Phaser)										
073	49	NO EFFECT										
:	:	:										
086	56	NO EFFECT										
087	57	ENSEMBLE DETUNE(EnsDetune)										
088	58	NO EFFECT										
:	:	:										
127	7F	NO EFFECT										

**VARIATION TYPE(0-63)**

TYPE MSB	TYPE LSB											
DEC	HEX	00	01	02	03 ... 07	08	09 ... 15	16	17	18	19	20
000	0	NO EFFECT										
001	1	HALL1(Hall1)	HALL2(Hall5)					(Hall2)	(Hall3)	(Hall4)		
002	2	ROOM1(Room5)	ROOM2(Room6)	ROOM3(Room7)				(Room1)	(Room2)	(Room3)	(Room4)	
003	3	STAGE1(Stage3)	STAGE2(Stage4)					(Stage1)	(Stage2)			
004	4	PLATE(Plate3)						(Plate1)	(Plate2)			
005	5	DELAY L,C,R(DelayLCR2)						(DelayLCR1)	(DelayLCR@T)			
006	6	DELAY L,R(DelayLR)						(DelayLR@T)				
007	7	ECHO(Echo)						(Echo@T)				
008	8	CROSS DELAY(CrossDelay)						(CrossDly@T)				
009	9	ER1(ER1)	ER2(ER2)									
010	A	GATE REVERB/GateReverb)										
011	B	REVERS GATE(ReverseGate)										
012	C	NO EFFECT or THRU*										
:	:	:										
015	F	NO EFFECT or THRU										
016	10	WHITE ROOM(WhiteRoom)										
017	11	TUNNEL(Tunnel)										
018	12	CANYON(Canyon)										
019	13	BASEMENT(Basement)										
020	14	KARAOKE 1(Karaoke1)	KARAOKE 2(Karaoke2)	KARAOKE 3(Karaoke3)								
021	15	NO EFFECT or THRU										
:	:	:										
063	3F	NO EFFECT or THRU*										

\*No effect when the effect connection is "system"; thru when "insertion".

# MIDI Data Format

## VARIATION TYPE(64~127)

TYPE MSB	TYPE LSB	01	02	03 ... 07	08	09 ... 15	16	17	18	19	20
DEC	HEX	00									
064	40	THRU									
065	41	CHORUS1(Chorus6)	CHORUS2(Chorus7)	CHORUS3(Chorus5)		CHORUS4(Chorus8)					
066	42	CELESTE1(Celeste1)	CELESTE2(Chorus4)	CELESTE3(Celeste2)		CELESTE4(Chorus2)	(Chorus3)	(Chorus1)	(RotarySp5)		
067	43	FLANGER 1(Flanger5)	FLANGER 2(Flanger4)		FLANGER 3(Flanger1)		(Flanger2)	(Flanger3)			
068	44	SYMPHONIC(Symphonic2)					(Symphonic1)				
069	45	ROTARY SP.(RotarySp6)					(RotarySp1)				
070	46	TREMOLO(Tremolo3)					(Tremolo1)	(RotarySp4)			
071	47	AUTO PAN(AutoPan2)					(AutoPan1)	(RotarySp2)	(RotarySp3)	(Tremolo2)	(GtrTremolo)
072	48	PHASER 1(Phaser1)			PHASER 2(Phaser2)						
073	49	DISTORTION(DistHvy)	COMP+DISTORTION (Comp+Dist)								
074	4A	OVER DRIVE(OverDrive)									
075	4B	AMP SIM.(AmpSim)					(DistHard)	(DistSoft)			
076	4C	3BAND EQ(3BandEQ)					(EQDisco)	(EQTel)			
077	4D	2BAND EQ(2BandEQ)									
078	4E	AUTO WAH(AutoWah2)	AUTO WAH+DIST (AtWah+Dist)	AUTO WAH+OVERDRIVE (AtWah+OD)			(AutoWah1)				
079	4F	THRU									
080	50	PITCH CHANGE(PitchChg1)	PITCH CHANGE2 (PitchChg2)								
081	51	THRU									
082	52	TOUCH WAH 1(TouchWah1)	TOUCH WAH+DIST (TcWah+Dist)	TOUCH WAH+OVERDRIVE (TcWah+OD)		TOUCH WAH 2 (TouchWah2)					
083	53	COMPRESSOR(Compressor)									
084	54	NOISE GATE(NoiseGate)									
085	55	VOICE CANCEL(VoiceCancel)									
086	56	2WAY ROTARY SP(2wayRotSp)									
087	57	ENSEMBLE DETUNE(EnsDetune)									
088	58	AMBIENCE(Ambience)									
089	59	THRU									
:	:	:									
127	7F	THRU									

## INSERTION TYPE

TYPE MSB	TYPE LSB	01	02	03 ... 07	08	09 ... 15	16	17	18	19	20
DEC	HEX	00									
000	0	THRU									
001	1	HALL1(Hall1)	HALL2(Hall5)				(Hall2)	(Hall3)	(Hall4)		
002	2	ROOM1(Room5)	ROOM2(Room6)	ROOM3(Room7)			(Room1)	(Room2)	(Room3)	(Room4)	
003	3	STAGE1(Stage3)	STAGE2(Stage4)				(Stage1)	(Stage2)			
004	4	PLATE(Plate3)					(Plate1)	(Plate2)			
005	5	DELAY L,C,R(DelayLCR2)					(DelayLCR1)	(DelayLCR@T)			
006	6	DELAY L,R(DelayLR)					(DelayLR@T)				
007	7	ECHO(Echo)					(Echo@T)				
008	8	CROSS DELAY(CrossDelay)					(CrossDly@T)				
009	9	THRU									
:	:	:									
019	13	THRU									
020	14	KARAOKE 1(Karaoke1)	KARAOKE 2(Karaoke2)	KARAOKE 3(Karaoke3)							
021	15	THRU									
:	:	:									
063	3F	THRU									
064	40	THRU									
065	41	CHORUS1(Chorus6)	CHORUS2(Chorus7)	CHORUS3(Chorus5)		CHORUS4(Chorus8)					
066	42	CELESTE1(Celeste1)	CELESTE2(Chorus4)	CELESTE3(Celeste2)		CELESTE4(Chorus2)	(Chorus3)	(Chorus1)	(RotarySp5)		
067	43	FLANGER 1(Flanger5)	FLANGER 2(Flanger4)		FLANGER 3(Flanger1)		(Flanger2)	(Flanger3)			
068	44	SYMPHONIC(Symphonic2)					(Symphonic1)				
069	45	ROTARY SP.(RotarySp6)					(RotarySp1)				
070	46	TREMOLO(Tremolo3)					(Tremolo1)	(RotarySp4)			
071	47	AUTO PAN(AutoPan2)					(AutoPan1)	(RotarySp2)	(RotarySp3)	(Tremolo2)	(GtrTremolo)
072	48	PHASER 1(Phaser)									
073	49	DISTORTION(DistHvy)	COMP+DISTORTION (Comp+Dist)								
074	4A	OVER DRIVE(OverDrive)									
075	4B	AMP SIM.(AmpSim)					(DistHard)	(DistSoft)			
076	4C	3BAND EQ(3BandEQ)					(EQDisco)	(EQTel)			
077	4D	2BAND EQ(2BandEQ)									
078	4E	AUTO WAH(AutoWah2)	AUTO WAH+DIST (AtWah+Dist)	AUTO WAH+OVERDRIVE (AtWah+OD)			(AutoWah1)				
079	4F	THRU									
080	50	THRU									
081	51	THRU									
082	52	TOUCH WAH 1(TouchWah1)	TOUCH WAH+DIST (TcWah+Dist)	TOUCH WAH+OVERDRIVE (TcWah+OD)		TOUCH WAH 2 (TouchWah2)					
083	53	COMPRESSOR(Compressor)									
084	54	NOISE GATE(NoiseGate)									
085	55	THRU									
086	56	THRU									
087	57	ENSEMBLE DETUNE(EnsDetune)									
088	58	THRU									
:	:	:									
127	7F	THRU									

< Table 1-12 > Effect Parameter List

\* Effect names in all caps are XG effects. Effect names in square brackets are panel effects.  
 \* Parameter 10 Dry/Wet only affects insertion type effects.

**HALL1,HALL2, ROOM1,ROOM2,ROOM3, STAGE1,STAGE2, PLATE (reverb, variation, insertion block)**  
**[Hall1..5, Room1..7, Stage1..4, Plate 1..3(Reverb,DSP3,DSP4-7)]**

No.	Parameter	Display	Value	See Table	Control
1	Reverb Time	0.3-30.0s	0-69	table#4	
2	Diffusion	0-10	0-10		
3	Initial Delay	0.1mS-99.3mS	0-63	table#5	
4	HPF Cutoff	Thru-8.0kHz	0-52	table#3	
5	LPF Cutoff	1.0k-Thru	34-60	table#3	
6					
7					
8					
9					
10	Dry/Wet	D63>W - D=W - D<W63	1-127		●
11	Rev Delay	0.1mS-99.3mS	0-63	table#5	
12	Density	0-4 (reverb, variation block) 0-2 (insertion block)	0-4 0-2		
13	Er/Rev Balance	E63>R - E=R - E<R63	1-127		
14	High Damp	0.1-1.0	1-10		
15	Feedback Level	-63+63	1-127		
16					

**WHITE ROOM, TUNNEL, CANYON, BASEMENT (reverb, variation block)**  
**[WhiteRoom, Tunnel, Canyon, Basement (Reverb,DSP3)]**

No.	Parameter	Display	Value	See Table	Control
1	Reverb Time	0.3-30.0s	0-69	table#4	
2	Diffusion	0-10	0-10		
3	Initial Delay	0.1mS-99.3mS	0-63	table#5	
4	HPF Cutoff	Thru-8.0kHz	0-52	table#3	
5	LPF Cutoff	1.0k-Thru	34-60	table#3	
6	Width	0.5-10.2m	0-37	table#11	
7	Height	0.5-20.2m	0-73	table#11	
8	Depth	0.5-30.2m	0-104	table#11	
9	Wall Vary	0-30	0-30		
10	Dry/Wet	D63>W - D=W - D<W63	1-127		●
11	Rev Delay	0.1mS-99.3mS	0-63	table#5	
12	Density	0-4	0-4		
13	Er/Rev Balance	E63>R - E=R - E<R63	1-127		
14	High Damp	0.1-1.0	1-10		
15	Feedback Level	-63+63	1-127		
16					

**DELAY L,C,R (variation, insertion block)**  
**[DelayLCR1..2 (DSP3,DSP4-7)]**

No.	Parameter	Display	Value	See Table	Control
1	Lch Delay	0.1-715.0ms (variation block) 0.1-715.0ms (insertion block)	1-7150		
2	Rch Delay	0.1-715.0ms (variation block) 0.1-715.0ms (insertion block)	1-7150		
3	Cch Delay	0.1-715.0ms (variation block) 0.1-715.0ms (insertion block)	1-7150		
4	Feedback Delay	0.1-715.0ms (variation block) 0.1-715.0ms (insertion block)	1-7150		
5	Feedback Level	-63+63	1-127		
6	Cch Level	0-127	0-127		
7	High Damp	0.1-1.0	1-10		
8					
9					
10	Dry/Wet	D63>W - D=W - D<W63	1-127		●
11					
12					
13	EQ Low Frequency	32Hz-2.0kHz	4-40	table#3	
14	EQ Low Gain	-12+12dB	52-76		
15	EQ High Frequency	500Hz-16.0kHz	28-58	table#3	
16	EQ High Gain	-12+12dB	52-76		

**DELAY L,R (variation, insertion block)**  
**[DelayLR (DSP3,DSP4-7)]**

No.	Parameter	Display	Value	See Table	Control
1	Lch Delay	0.1-715.0ms (variation block) 0.1-715.0ms (insertion block)	1-7150		
2	Rch Delay	0.1-715.0ms (variation block) 0.1-715.0ms (insertion block)	1-7150		
3	Feedback Delay 1	0.1-715.0ms (variation block) 0.1-715.0ms (insertion block)	1-7150		
4	Feedback Delay 2	0.1-715.0ms (variation block) 0.1-715.0ms (insertion block)	1-7150		
5	Feedback Level	-63+63	1-127		
6	High Damp	0.1-1.0	1-10		
7					
8					
9					
10	Dry/Wet	D63>W - D=W - D<W63	1-127		●
11					
12					
13	EQ Low Frequency	32Hz-2.0kHz	4-40	table#3	
14	EQ Low Gain	-12+12dB	52-76		
15	EQ High Frequency	500Hz-16.0kHz	28-58	table#3	
16	EQ High Gain	-12+12dB	52-76		

**ECHO (variation, insertion block)**  
**[Echo (DSP3,DSP4-7)]**

No.	Parameter	Display	Value	See Table	Control
1	Lch Delay1	0.1-355.0ms (variation block) 0.1-355.0ms (insertion block)	1-3550		
2	Lch Feedback Level	-63+63	1-127		
3	Rch Delay1	0.1-355.0ms (variation block) 0.1-355.0ms (insertion block)	1-3550		
4	Rch Feedback Level	-63+63	1-127		
5	High Damp	0.1-1.0	1-10		
6	Lch Delay2	0.1-355.0ms (variation block) 0.1-355.0ms (insertion block)	1-3550		
7	Rch Delay2	0.1-355.0ms (variation block) 0.1-355.0ms (insertion block)	1-3550		
8	Delay2 Level	0-127	0-127		
9					
10	Dry/Wet	D63>W - D=W - D<W63	1-127		●
11					
12					
13	EQ Low Frequency	32Hz-2.0kHz	4-40	table#3	
14	EQ Low Gain	-12+12dB	52-76		
15	EQ High Frequency	500Hz-16.0kHz	28-58	table#3	
16	EQ High Gain	-12+12dB	52-76		

**CROSS DELAY (variation, insertion block)**  
**[CrossDelay (DSP3,DSP4-7)]**

No.	Parameter	Display	Value	See Table	Control
1	L->R Delay	0.1-355.0ms (variation block) 0.1-355.0ms (insertion block)	1-3550		
2	R->L Delay	0.1-355.0ms (variation block) 0.1-355.0ms (insertion block)	1-3550		
3	Feedback Level	-63+63	1-127		
4	Input Select	L,R,L&R	0-2		
5	High Damp	0.1-1.0	1-10		
6					
7					
8					
9					
10	Dry/Wet	D63>W - D=W - D<W63	1-127		●
11					
12					
13	EQ Low Frequency	32Hz-2.0kHz	4-40	table#3	
14	EQ Low Gain	-12+12dB	52-76		
15	EQ High Frequency	500Hz-16.0kHz	28-58	table#3	
16	EQ High Gain	-12+12dB	52-76		

**EARLY REF1,EARLY REF2(variation block)**  
**[ER1..2(DSP3)]**

No.	Parameter	Display	Value	See Table	Control
1	Type	S-H, L-H, Rdm, Rvs, Plt, Spr	0-5		
2	Room Size	0.1-7.0	0-44	table#6	
3	Diffusion	0-10	0-10		
4	Initial Delay	0.1mS-99.3mS	0-63	table#5	
5	Feedback Level	-63+63	1-127		
6	HPF Cutoff	Thru-8.0kHz	0-52	table#3	
7	LPF Cutoff	1.0k-Thru	34-60	table#3	
8					
9					
10	Dry/Wet	D63>W - D=W - D<W63	1-127		●
11	Liveness	0-10	0-10		
12	Density	0-3	0-3		
13	High Damp	0.1-1.0	1-10		
14					
15					
16					

**GATE REVERB, REVERSE GATE (variation block)**  
**[GateReverb, ReversGate (DSP3)]**

No.	Parameter	Display	Value	See Table	Control
1	Type	TypeA, TypeB	0-1		
2	Room Size	0.1-7.0	0-44	table#6	
3	Diffusion	0-10	0-10		
4	Initial Delay	0.1mS-200.0mS	0-127	table#5	
5	Feedback Level	-63+63	1-127		
6	HPF Cutoff	Thru-8.0kHz	0-52	table#3	
7	LPF Cutoff	1.0k-Thru	34-60	table#3	
8					
9					
10	Dry/Wet	D63>W - D=W - D<W63	1-127		●
11	Liveness	0-10	0-10		
12	Density	0-3	0-3		
13	High Damp	0.1-1.0	1-10		
14					
15					
16					

**KARAOKE1,2,3 (variation, insertion block)**  
**[Karaoke1..3 (DSP3,DSP4-7)]**

No.	Parameter	Display	Value	See Table	Control
1	Delay Time	0.1mS-400.0mS	0-127	table#7	
2	Feedback Level	-63+63	1-127		
3	HPF Cutoff	Thru-8.0kHz	0-52	table#3	
4	LPF Cutoff	1.0k-Thru	34-60	table#3	
5					
6					
7					
8					
9					
10	Dry/Wet	D63>W - D=W - D<W63	1-127		●
11					
12					
13					
14					
15					
16					

**CHORUS1,2,3,4, CELESTE1,2,3,4 (chorus, variation, insertion block)**  
**[RotarySp5, Chorus1..8, Celeste1,2 (Chorus,DSP3,DSP4-7)]**

No.	Parameter	Display	Value	See Table	Control
1	LFO Frequency	0.00Hz-39.7Hz	0-127	table#1	
2	LFO Depth	0-127	0-127		
3	Feedback Level	-63+63	1-127		
4	Delay Offset	0.0mS-50mS	0-127	table#2	
5					
6	EQ Low Frequency	32Hz-2.0kHz	4-40	table#3	
7	EQ Low Gain	-12+12dB	52-76		
8	EQ High Frequency	500Hz-16.0kHz	28-58	table#3	
9	EQ High Gain	-12+12dB	52-76		
10	Dry/Wet	D63>W - D=W - D<W63	1-127		●
11	EQ Mid Frequency	100Hz-10.0kHz (variation block)	14-54	table#3	
12	EQ Mid Gain	-12+12dB (variation block)	52-76		
13	EQ Mid Width	1.0-12.0 (variation block)	10-120		
14					
15	Input Mode	mono/stereo	0-1		
16					

# MIDI Data Format

## FLANGER1,2,3 (chorus, variation, insertion block)

No.	Parameter	Display	Value	See Table	Control
1	LFO Frequency	0.00Hz~39.7Hz	0-127	table#1	
2	LFO Depth	0~127	0-127		
3	Feedback Level	-63~+63	0-127		
4	Delay Offset	0.0mS~50mS	0-127	table#2	
5					
6	EQ Low Frequency	32Hz~2.0kHz	4-40	table#3	
7	EQ Low Gain	-12~+12dB	52-76		
8	EQ High Frequency	500Hz~16.0kHz	28-58	table#3	
9	EQ High Gain	-12~+12dB	52-76		
10	Dry/Wet	D63>W ~ D=W ~ D<W63	1-127		●
11	EQ Mid Frequency	100Hz~10.0kHz (variation block)	14-54	table#3	
12	EQ Mid Gain	-12~+12dB (variation block)	52-76		
13	EQ Mid Width	1.0~12.0 (variation block)	10-120		
14	LFO Phase Difference	-180~+180deg(resolution=3deg.)	4-124		
15					
16					

## SYMPHONIC (chorus, variation, insertion block)

No.	Parameter	Display	Value	See Table	Control
1	LFO Frequency	0.00Hz~39.7Hz	0-127	table#1	
2	LFO Depth	0~127	0-127		
3	Delay Offset	0.0mS~50mS	0-127	table#2	
4					
5					
6	EQ Low Frequency	32Hz~2.0kHz	4-40	table#3	
7	EQ Low Gain	-12~+12dB	52-76		
8	EQ High Frequency	500Hz~16.0kHz	28-58	table#3	
9	EQ High Gain	-12~+12dB	52-76		
10	Dry/Wet	D63>W ~ D=W ~ D<W63	1-127		●
11	EQ Mid Frequency	100Hz~10.0kHz (variation block)	14-54	table#3	
12	EQ Mid Gain	-12~+12dB (variation block)	52-76		
13	EQ Mid Width	1.0~12.0 (variation block)	10-120		
14					
15					
16					

## ENSEMBLE DETUNE (chorus, variation, insertion block)

No.	Parameter	Display	Value	See Table	Control
1	Detune	-50~+50cent	14-114		
2	Lch Init Delay	0.0mS~50mS	0-127	table#2	
3	Rch Init Delay	0.0mS~50mS	0-127	table#2	
4					
5					
6					
7					
8					
9					
10	Dry/Wet	D63>W ~ D=W ~ D<W63	1-127		●
11	EQ Low Frequency	32Hz~2.0kHz (variation, insertion block)	4-40	table#3	
12	EQ Low Gain	-12~+12dB (variation, insertion block)	52-76		
13	EQ High Frequency	500Hz~16.0kHz (variation, insertion block)	28-58	table#3	
14	EQ High Gain	-12~+12dB (variation, insertion block)	52-76		
15					
16					

## AMBIENCE (variation block)

No.	Parameter	Display	Value	See Table	Control
1	Delay Time	0.0mS~50mS	0-127	table#2	
2	Output Phase	normal/invers	0-1		
3					
4					
5					
6	EQ Low Frequency	32Hz~2.0kHz	4-40	table#3	
7	EQ Low Gain	-12~+12dB	52-76		
8	EQ High Frequency	500Hz~16.0kHz	28-58	table#3	
9	EQ High Gain	-12~+12dB	52-76		
10	Dry/Wet	D63>W ~ D=W ~ D<W63	1-127		●
11					
12					
13					
14					
15					
16					

## ROTARY SPEAKER (variation, insertion block)

No.	Parameter	Display	Value	See Table	Control
1	LFO Frequency	0.00Hz~39.7Hz	0-127	table#1	●
2	LFO Depth	0~127	0-127		
3					
4					
5					
6	EQ Low Frequency	32Hz~2.0kHz	4-40	table#3	
7	EQ Low Gain	-12~+12dB	52-76		
8	EQ High Frequency	500Hz~16.0kHz	28-58	table#3	
9	EQ High Gain	-12~+12dB	52-76		
10	Dry/Wet	D63>W ~ D=W ~ D<W63	1-127		
11	EQ Mid Frequency	100Hz~10.0kHz (variation block)	14-54	table#3	
12	EQ Mid Gain	-12~+12dB (variation block)	52-76		
13	EQ Mid Width	1.0~12.0 (variation block)	10-120		
14					
15					
16					

## 2WAY ROTARY SPEAKER (variation block)

No.	Parameter	Display	Value	See Table	Control
1	Rotor Speed	0.0Hz~39.7Hz	0-127	table#1	●
2	Drive Low	0~127	0-127		
3	Drive High	0~127	0-127		
4	Low/High	L63>H ~ L=H ~ L<H63	1-127		
5					
6	EQ Low Frequency	32Hz~2.0kHz	4-40	table#3	
7	EQ Low Gain	-12~+12dB	52-76		
8	EQ High Frequency	500Hz~16.0kHz	28-58	table#3	
9	EQ High Gain	-12~+12dB	52-76		
10					
11	Crossover Frequency	100Hz~10.0kHz	14-54	table#3	
12	Mic L-R Angle	0deg~180deg(resolution=3deg.)	0-60		
13					
14					
15					
16					

## TREMOLO (variation, insertion block)

No.	Parameter	Display	Value	See Table	Control
1	LFO Frequency	0.00Hz~39.7Hz	0-127	table#1	●
2	AM Depth	0~127	0-127		
3	PM Depth	0~127	0-127		
4					
5					
6	EQ Low Frequency	32Hz~2.0kHz	4-40	table#3	
7	EQ Low Gain	-12~+12dB	52-76		
8	EQ High Frequency	500Hz~16.0kHz	28-58	table#3	
9	EQ High Gain	-12~+12dB	52-76		
10					
11	EQ Mid Frequency	100Hz~10.0kHz (variation block)	14-54	table#3	
12	EQ Mid Gain	-12~+12dB (variation block)	52-76		
13	EQ Mid Width	1.0~12.0 (variation block)	10-120		
14	LFO Phase Difference	-180~+180deg(resolution=3deg.)	4-124		
15	Input Mode	mono/stereo	0-1		
16					

## AUTO PAN (variation, insertion block)

No.	Parameter	Display	Value	See Table	Control
1	LFO Frequency	0.00Hz~39.7Hz	0-127	table#1	●
2	L/R Depth	0~127	0-127		
3	F/R Depth	0~127	0-127		
4	PAN Direction	L<->R,L->R,L<-R,Lturn,Rturn,L/R	0-5		
5					
6	EQ Low Frequency	32Hz~2.0kHz	4-40	table#3	
7	EQ Low Gain	-12~+12dB	52-76		
8	EQ High Frequency	500Hz~16.0kHz	28-58	table#3	
9	EQ High Gain	-12~+12dB	52-76		
10					
11	EQ Mid Frequency	100Hz~10.0kHz (variation block)	14-54	table#3	
12	EQ Mid Gain	-12~+12dB (variation block)	52-76		
13	EQ Mid Width	1.0~12.0 (variation block)	10-120		
14					
15					
16					

## PHASER 1 (chorus, variation, insertion block)

No.	Parameter	Display	Value	See Table	Control
1	LFO Frequency	0.00Hz~39.7Hz	0-127	table#1	
2	LFO Depth	0~127	0-127		
3	Phase Shift Offset	0~127	0-127		
4	Feedback Level	-63~+63	1-127		
5					
6	EQ Low Frequency	32Hz~2.0kHz	4-40	table#3	
7	EQ Low Gain	-12~+12dB	52-76		
8	EQ High Frequency	500Hz~16.0kHz	28-58	table#3	
9	EQ High Gain	-12~+12dB	52-76		
10	Dry/Wet	D63>W ~ D=W ~ D<W63	1-127		●
11	Stage	4,5,6 (chorus, insertion block)	4-6		
12	Diffusion	4~12 (variation block)	4-12		
13		mono/stereo	0-1		
14					
15					
16					

## PHASER 2 (variation block)

No.	Parameter	Display	Value	See Table	Control
1	LFO Frequency	0.00Hz~39.7Hz	0-127	table#1	
2	LFO Depth	0~127	0-127		
3	Phase Shift Offset	0~127	0-127		
4	Feedback Level	-63~+63	1-127		
5					
6	EQ Low Frequency	32Hz~2.0kHz	4-40	table#3	
7	EQ Low Gain	-12~+12dB	52-76		
8	EQ High Frequency	500Hz~16.0kHz	28-58	table#3	
9	EQ High Gain	-12~+12dB	52-76		
10	Dry/Wet	D63>W ~ D=W ~ D<W63	1-127		●
11	Stage	4,5,6(MU90ÇÖ3..6)	4-6		
12					
13	LFO Phase Difference	-180deg~+180deg(resolution=3deg.)	4-124		
14					
15					
16					

## DISTORTION, OVERDRIVE (variation, insertion block)

No.	Parameter	Display	Value	See Table	Control
1	Drive	0~127	0-127		●
2	EQ Low Frequency	32Hz~2.0kHz	4-40	table#3	
3	EQ Low Gain	-12~+12dB	52-76		
4	LPF Cutoff	1.0k~Thru	34-60	table#3	
5	Output Level	0~127	0-127		
6					
7	EQ Mid Frequency	100Hz~10.0kHz	14-54	table#3	
8	EQ Mid Gain	-12~+12dB	52-76		
9	EQ Mid Width	1.0~12.0	10-120		
10	Dry/Wet	D63>W ~ D=W ~ D<W63	1-127		
11	Edge(Clip Curve)	0~127	0-127	mild~sharp	
12					
13					
14					
15					
16					

## COMP+DIST (variation block)

No.	Parameter	Display	Value	See Table	Control
1	Drive	0~127	0-127		●
2	EQ Low Frequency	32Hz~2.0kHz	4-40	table#3	
3	EQ Low Gain	-12~+12dB	52-76		
4	LPF Cutoff	1.0k~Thru	34-60	table#3	
5	Output Level	0~127	0-127		
6					
7	EQ Mid Frequency	100Hz~10.0kHz	14-54	table#3	
8	EQ Mid Gain	-12~+12dB	52-76		
9	EQ Mid Width	1.0~12.0	10-120		
10	Dry/Wet	D63>W ~ D=W ~ D<W63	1-127		
11	Edge(Clip Curve)	0~127	0-127	mild~sharp	
12	Attack	1ms~40ms	0-19	table#8	
13	Release	10ms~680ms	0-15	table#9	
14	Threshold	-48dB~6dB	79-121		
15	Ratio	1.0~20.0	0-7	table#10	
16					



## AMP SIMULATOR (variation, insertion block) [DistHard, DistSoft, AmpSim(DSP3,DSP4-7)]

No.	Parameter	Display	Value	See Table	Control
1	Drive	0-127	0-127		●
2	AMP Type	Off.Stack,Combo,Tube	0-3		
3	LPF Cutoff	1.0k-Thru	34-60	table#3	
4	Output Level	0-127	0-127		
5					
6					
7					
8					
9					
10	Dry/Wet	D63>W ~ D=W ~ D<W63	1-127		
11	Edge(Clip Curve)	0-127	0-127	mild-sharp	
12					
13					
14					
15					
16					

## 3BAND EQ(MONO) (variation, insertion block) [EQDisco, EQTel, 3BandEQ(DSP3,DSP4-7)]

No.	Parameter	Display	Value	See Table	Control
1	EQ Low Gain	-12~+12dB	52-76	table#3	
2	EQ Mid Frequency	100Hz~10.0kHz	14-54		
3	EQ Mid Gain	-12~+12dB	52-76		
4	EQ Mid Width	1.0-12.0	10-120		
5	EQ High Gain	-12~+12dB	52-76		
6	EQ Low Frequency	50Hz~2.0kHz	8-40	table#3	
7	EQ High Frequency	500Hz~16.0kHz	28-58	table#3	
8					
9					
10					
11					
12					
13					
14					
15	Input Mode	mono/stereo	0-1		
16					

## 2BAND EQ(STEREO) (variation, insertion block) [2BandEQ(DSP3,DSP4-7)]

No.	Parameter	Display	Value	See Table	Control
1	EQ Low Frequency	32Hz~2.0kHz	4-40	table#3	
2	EQ Low Gain	-12~+12dB	52-76		
3	EQ High Frequency	500Hz~16.0kHz	28-58	table#3	
4	EQ High Gain	-12~+12dB	52-76		
5					
6					
7					
8					
9					
10					
11					
12					
13					
14					
15					
16					

## AUTO WAH (variation, insertion block) [AutoWah1.2 (DSP3,DSP4-7)]

No.	Parameter	Display	Value	See Table	Control
1	LFO Frequency	0.00Hz~39.7Hz	0-127	table#1	
2	LFO Depth	0-127	0-127		●
3	Cutoff Frequency Offset	0-127	0-127		
4	Resonance	1.0-12.0	10-120		
5					
6	EQ Low Frequency	32Hz~2.0kHz	4-40	table#3	
7	EQ Low Gain	-12~+12dB	52-76		
8	EQ High Frequency	500Hz~16.0kHz	28-58	table#3	
9	EQ High Gain	-12~+12dB	52-76		
10	Dry/Wet	D63>W ~ D=W ~ D<W63	1-127		
11	Drive	0-127(variation block)	0-127		
12					
13					
14					
15					
16					

## AUTO WAH+DIST, AUTO WHA+ODRV (variation block) [Autowah+Dist, AtWah+OD(DSP3)]

No.	Parameter	Display	Value	See Table	Control
1	LFO Frequency	0.00Hz~39.7Hz	0-127	table#1	
2	LFO Depth	0-127	0-127		●
3	Cutoff Frequency Offset	0-127	0-127		
4	Resonance	1.0-12.0	10-120		
5					
6	EQ Low Frequency	32Hz~2.0kHz	4-40	table#3	
7	EQ Low Gain	-12~+12dB	52-76		
8	EQ High Frequency	500Hz~16.0kHz	28-58	table#3	
9	EQ High Gain	-12~+12dB	52-76		
10	Dry/Wet	D63>W ~ D=W ~ D<W63	1-127		
11	Drive	0-127	0-127		
12	EQ Low Gain(distortion)	-12~+12dB	52-76		
13	EQ Mid Gain(distortion)	-12~+12dB	52-76		
14	LPF Cutoff	1.0kHz-thru	34-60	table#3	
15	Output Level	0-127	0-127		
16					

## TOUCH WAH 1 (variation, insertion block), TOUCH WAH+DIST (variation block) [TouchWah1 (DSP3,DSP4-7), TcWah+Dist (DSP3)]

No.	Parameter	Display	Value	See Table	Control
1	Sensitive	0-127	0-127		●
2	Cutoff Frequency Offset	0-127	0-127		
3	Resonance	1.0-12.0	10-120		
4					
5					
6	EQ Low Frequency	32Hz~2.0kHz	4-40	table#3	
7	EQ Low Gain	-12~+12dB	52-76		
8	EQ High Frequency	500Hz~16.0kHz	28-58	table#3	
9	EQ High Gain	-12~+12dB	52-76		
10	Dry/Wet	D63>W ~ D=W ~ D<W63	1-127		
11	Drive	0-127(variation block)	0-127		
12					
13					
14					
15					
16					

## TOUCH WAH 2 (variation, insertion block), TOUCH WAH+ODRV (variation block) [TouchWah2 (DSP3,DSP4-7), TcWah+OD(DSP3)]

No.	Parameter	Display	Value	See Table	Control
1	Sensitive	0-127	0-127		●
2	Cutoff Frequency Offset	0-127	0-127		
3	Resonance	1.0-12.0	10-120		
4					
5					
6	EQ Low Frequency	32Hz~2.0kHz	4-40	table#3	
7	EQ Low Gain	-12~+12dB	52-76		
8	EQ High Frequency	500Hz~16.0kHz	28-58	table#3	
9	EQ High Gain	-12~+12dB	52-76		
10	Dry/Wet	D63>W ~ D=W ~ D<W63	1-127		
11	Drive	0-127(variation block)	0-127		
12	EQ Low Gain(distortion)	-12~+12dB(variation block)	52-76		
13	EQ Mid Gain(distortion)	-12~+12dB(variation block)	52-76		
14	LPF Cutoff	1.0kHz-thru(variation block)	34-60	table#3	
15	Output Level	0-127(variation block)	0-127		
16					

## PITCH CHANGE 1 (variation block) [PitchChg1(DSP3)]

No.	Parameter	Display	Value	See Table	Control
1	Pitch	-24~+24	40-88		
2	Initial Delay	0.1mS~400.0mS	0-127	table#7	
3	Fine 1	-50~+50	14-114		
4	Fine 2	-50~+50	14-114		
5	Feedback Level	-63~+63	1-127		
6					
7					
8					
9					
10	Dry/Wet	D63>W ~ D=W ~ D<W63	1-127		●
11	Pan 1	L63~R63	1-127		
12	Output Level 1	0-127	0-127		
13	Pan 2	L63~R63	1-127		
14	Output Level 2	0-127	0-127		
15					
16					

## PITCH CHANGE 2 (variation block) [PitchChg2 (DSP3)]

No.	Parameter	Display	Value	See Table	Control
1	Pitch	-24~+24	40-88		
2	Initial Delay	0.1mS~400.0mS	0-127	table#7	
3	Fine 1	-50~+50cent	14-114		
4	Fine 2	-50~+50cent	14-114		
5	Feedback Level	-63~+63	1-127		
6					
7					
8					
9					
10	Dry/Wet	D63>W ~ D=W ~ D<W63	1-127		●
11	Pan 1	L63~R63	1-127		
12	Output Level 1	0-127	0-127		
13	Pan 2	L63~R63	1-127		
14	Output Level 2	0-127	0-127		
15					
16					

## COMPRESSOR (variation, insertion block) [Compressor (DSP3,DSP4-7)]

No.	Parameter	Display	Value	See Table	Control
1	Attack	1~40ms	0-19	table#8	
2	Release	10~680ms	0-15	table#9	
3	Threshold	-48~-6dB	79-121		
4	Ratio	1.0-20.0	0-7	table#10	
5	Output Level	0-127	0-127		
6					
7					
8					
9					
10					
11					
12					
13					
14					
15					
16					

## NOISE GATE (variation, insertion block) [NoiseGate (DSP3,DSP4-7)]

No.	Parameter	Display	Value	See Table	Control
1	Attack	1~40ms	0-19	table#8	
2	Release	10~680ms	0-15	table#9	
3	Threshold	-72~-30dB	55-97		
4	Output Level	0-127	0-127		
5					
6					
7					
8					
9					
10					
11					
12					
13					
14					
15					
16					

## VOICE CANCEL (variation block) [VoiceCancel (DSP3)]

No.	Parameter	Display	Value	See Table	Control
1					
2					
3					
4					
5					
6					
7					
8					
9					
10					
11	Low Adjust	0~26	0-26		
12	High Adjust	0~26	0-26		
13					
14					
15					
16					

**NO EFFECT (reverb, chorus, variation block)**  
**[NoEffect (Reverb,Chorus,DSP3)]**

No.	Parameter	Display	Value	See Table	Control
1					
2					
3					
4					
5					
6					
7					
8					
9					
10					
11					
12					
13					
14					
15					
16					

**THRU (variation, insertion block)**  
**[Thru (DSP3,DSP4-7)]**

No.	Parameter	Display	Value	See Table	Control
1					
2					
3					
4					
5					
6					
7					
8					
9					
10					
11					
12					
13					
14					
15					
16					

**[DelayLCR@T (DSP3,DSP4-7)]**

No.	Parameter	Display	Value	See Table	Control
1	Lch Delay	16th,16th/3,16th,.8th,8th/3,8th,.4th,4th/3,4th.	1-7150	table#12	
2	Rch Delay	16th,16th/3,16th,.8th,8th/3,8th,.4th,4th/3,4th.	1-7150	table#12	
3	Cch Delay	16th,16th/3,16th,.8th,8th/3,8th,.4th,4th/3,4th.	1-7150	table#12	
4	Feedback Delay	16th,16th/3,16th,.8th,8th/3,8th,.4th,4th/3,4th.	1-7150	table#12	
5	Feedback Level	-63~+63	1-127		
6	Cch Level	0~127	0-127		
7	High Damp	0.1~1.0	1-10		
8					
9					
10	Dry/Wet	D63>W - D=W - D<W63	1-127		●
11					
12					
13	EQ Low Frequency	32Hz~2.0kHz	4-40	table#3	
14	EQ Low Gain	-12~+12dB	52-76		
15	EQ High Frequency	500Hz~16.0kHz	28-58	table#3	
16	EQ High Gain	-12~+12dB	52-76		

**[DelayLR@T (DSP3,DSP4-7)]**

No.	Parameter	Display	Value	See Table	Control
1	Lch Delay	16th,16th/3,16th,.8th,8th/3,8th,.4th,4th/3,4th.	1-7150	table#12	
2	Rch Delay	16th,16th/3,16th,.8th,8th/3,8th,.4th,4th/3,4th.	1-7150	table#12	
3	Feedback Delay 1	16th,16th/3,16th,.8th,8th/3,8th,.4th,4th/3,4th.	1-7150	table#12	
4	Feedback Delay 2	16th,16th/3,16th,.8th,8th/3,8th,.4th,4th/3,4th.	1-7150	table#12	
5	Feedback Level	-63~+63	1-127		
6	High Damp	0.1~1.0	1-10		
7					
8					
9					
10	Dry/Wet	D63>W - D=W - D<W63	1-127		●
11					
12					
13	EQ Low Frequency	32Hz~2.0kHz	4-40	table#3	
14	EQ Low Gain	-12~+12dB	52-76		
15	EQ High Frequency	500Hz~16.0kHz	28-58	table#3	
16	EQ High Gain	-12~+12dB	52-76		

**[Echo@T (DSP3,DSP4-7)]**

No.	Parameter	Display	Value	See Table	Control
1	Lch Delay1	16th,16th/3,16th,.8th,8th/3,8th.	1-3550	table#12	
2	Lch Feedback Level	-63~+63	1-127		
3	Rch Delay1	16th,16th/3,16th,.8th,8th/3,8th.	1-3550	table#12	
4	Rch Feedback Level	-63~+63	1-127		
5	High Damp	0.1~1.0	1-10		
6	Lch Delay2	16th,16th/3,16th,.8th,8th/3,8th.	1-3550	table#12	
7	Rch Delay2	16th,16th/3,16th,.8th,8th/3,8th.	1-3550	table#12	
8	Delay2 Level	0~127	0-127		
9					
10	Dry/Wet	D63>W - D=W - D<W63	1-127		●
11					
12					
13	EQ Low Frequency	32Hz~2.0kHz	4-40	table#3	
14	EQ Low Gain	-12~+12dB	52-76		
15	EQ High Frequency	500Hz~16.0kHz	28-58	table#3	
16	EQ High Gain	-12~+12dB	52-76		

**[CrossDly@T (DSP3,DSP4-7)]**

No.	Parameter	Display	Value	See Table	Control
1	L->R Delay	16th,16th/3,16th,.8th,8th/3,8th.	1-3550	table#12	
2	R->L Delay	16th,16th/3,16th,.8th,8th/3,8th.	1-3550	table#12	
3	Feedback Level	-63~+63	1-127		
4	Input Select	L,R,L&R	0-2		
5	High Damp	0.1~1.0	1-10		
6					
7					
8					
9					
10	Dry/Wet	D63>W - D=W - D<W63	1-127		●
11					
12					
13	EQ Low Frequency	32Hz~2.0kHz	4-40	table#3	
14	EQ Low Gain	-12~+12dB	52-76		
15	EQ High Frequency	500Hz~16.0kHz	28-58	table#3	
16	EQ High Gain	-12~+12dB	52-76		

## &lt; Table 1-13 &gt; Effect Data Value Assign Table

Table#1  
LFO Frequency

Data	Value	Data	Value	Data	Value	Data	Value
0	0.00	32	1.35	64	2.69	96	8.41
1	0.04	33	1.39	65	2.78	97	8.75
2	0.08	34	1.43	66	2.86	98	9.08
3	0.13	35	1.47	67	2.94	99	9.42
4	0.17	36	1.51	68	3.03	100	9.76
5	0.21	37	1.56	69	3.11	101	10.1
6	0.25	38	1.60	70	3.20	102	10.8
7	0.29	39	1.64	71	3.28	103	11.4
8	0.34	40	1.68	72	3.37	104	12.1
9	0.38	41	1.72	73	3.45	105	12.8
10	0.42	42	1.77	74	3.53	106	13.5
11	0.46	43	1.81	75	3.62	107	14.1
12	0.51	44	1.85	76	3.70	108	14.8
13	0.55	45	1.89	77	3.87	109	15.5
14	0.59	46	1.94	78	4.04	110	16.2
15	0.63	47	1.98	79	4.21	111	16.8
16	0.67	48	2.02	80	4.37	112	17.5
17	0.72	49	2.06	81	4.54	113	18.2
18	0.76	50	2.10	82	4.71	114	19.5
19	0.80	51	2.15	83	4.88	115	20.9
20	0.84	52	2.19	84	5.05	116	22.2
21	0.88	53	2.23	85	5.22	117	23.6
22	0.93	54	2.27	86	5.38	118	24.9
23	0.97	55	2.31	87	5.55	119	26.2
24	1.01	56	2.36	88	5.72	120	27.6
25	1.05	57	2.40	89	6.06	121	28.9
26	1.09	58	2.44	90	6.39	122	30.3
27	1.14	59	2.48	91	6.73	123	31.6
28	1.18	60	2.52	92	7.07	124	33.0
29	1.22	61	2.57	93	7.40	125	34.3
30	1.26	62	2.61	94	7.74	126	37.0
31	1.30	63	2.65	95	8.08	127	39.7

Table#4  
Reverb time

Data	Value	Data	Value	Data	Value
0	0.3	32	3.5	64	17.0
1	0.4	33	3.6	65	18.0
2	0.5	34	3.7	66	19.0
3	0.6	35	3.8	67	20.0
4	0.7	36	3.9	68	25.0
5	0.8	37	4.0	69	30.0
6	0.9	38	4.1		
7	1.0	39	4.2		
8	1.1	40	4.3		
9	1.2	41	4.4		
10	1.3	42	4.5		
11	1.4	43	4.6		
12	1.5	44	4.7		
13	1.6	45	4.8		
14	1.7	46	4.9		
15	1.8	47	5.0		
16	1.9	48	5.0		
17	2.0	49	5.5		
18	2.1	50	6.5		
19	2.2	51	7.0		
20	2.3	52	7.5		
21	2.4	53	8.0		
22	2.5	54	8.5		
23	2.6	55	9.0		
24	2.7	56	9.5		
25	2.8	57	10.0		
26	2.9	58	11.0		
27	3.0	59	12.0		
28	3.1	60	13.0		
29	3.2	61	14.0		
30	3.3	62	15.0		
31	3.4	63	16.0		

Table#7  
Delay Time(400.0ms)

Data	Value	Data	Value	Data	Value	Data	Value
0	0.1	32	100.9	64	201.6	96	302.4
1	3.2	33	104.0	65	204.8	97	305.5
2	6.4	34	107.2	66	207.9	98	308.7
3	9.5	35	110.3	67	211.1	99	311.8
4	12.7	36	113.5	68	214.2	100	315.0
5	15.8	37	116.6	69	217.4	101	318.1
6	19.0	38	119.8	70	220.5	102	321.3
7	22.1	39	122.9	71	223.7	103	324.4
8	25.3	40	126.1	72	226.8	104	327.6
9	28.4	41	129.2	73	230.0	105	330.7
10	31.6	42	132.4	74	233.1	106	333.9
11	34.7	43	135.5	75	236.3	107	337.0
12	37.9	44	138.6	76	239.4	108	340.2
13	41.0	45	141.8	77	242.6	109	343.3
14	44.2	46	144.9	78	245.7	110	346.5
15	47.3	47	148.1	79	248.9	111	349.6
16	50.5	48	151.2	80	252.0	112	352.8
17	53.6	49	154.4	81	255.2	113	355.9
18	56.8	50	157.5	82	258.3	114	359.1
19	59.9	51	160.7	83	261.5	115	362.2
20	63.1	52	163.8	84	264.6	116	365.4
21	66.2	53	167.0	85	267.7	117	368.5
22	69.4	54	170.1	86	270.9	118	371.7
23	72.5	55	173.3	87	274.0	119	374.8
24	75.7	56	176.4	88	277.2	120	378.0
25	78.8	57	179.6	89	280.3	121	381.1
26	82.0	58	182.7	90	283.5	122	384.3
27	85.1	59	185.9	91	286.6	123	387.4
28	88.3	60	189.0	92	289.8	124	390.6
29	91.4	61	192.2	93	292.9	125	393.7
30	94.6	62	195.3	94	296.1	126	396.9
31	97.7	63	198.5	95	299.2	127	400.0

Table#2  
Modulation Delay Offset

Data	Value	Data	Value	Data	Value	Data	Value
0	0.0	32	3.2	64	6.4	96	9.6
1	0.1	33	3.3	65	6.5	97	9.7
2	0.2	34	3.4	66	6.6	98	9.8
3	0.3	35	3.5	67	6.7	99	9.9
4	0.4	36	3.6	68	6.8	100	10.0
5	0.5	37	3.7	69	6.9	101	11.1
6	0.6	38	3.8	70	7.0	102	12.2
7	0.7	39	3.9	71	7.1	103	13.3
8	0.8	40	4.0	72	7.2	104	14.4
9	0.9	41	4.1	73	7.3	105	15.5
10	1.0	42	4.2	74	7.4	106	17.1
11	1.1	43	4.3	75	7.5	107	18.6
12	1.2	44	4.4	76	7.6	108	20.2
13	1.3	45	4.5	77	7.7	109	21.8
14	1.4	46	4.6	78	7.8	110	23.3
15	1.5	47	4.7	79	7.9	111	24.9
16	1.6	48	4.8	80	8.0	112	26.5
17	1.7	49	4.9	81	8.1	113	28.0
18	1.8	50	5.0	82	8.2	114	29.6
19	1.9	51	5.1	83	8.3	115	31.2
20	2.0	52	5.2	84	8.4	116	32.8
21	2.1	53	5.3	85	8.5	117	34.3
22	2.2	54	5.4	86	8.6	118	35.9
23	2.3	55	5.5	87	8.7	119	37.5
24	2.4	56	5.6	88	8.8	120	39.0
25	2.5	57	5.7	89	8.9	121	40.6
26	2.6	58	5.8	90	9.0	122	42.2
27	2.7	59	5.9	91	9.1	123	43.7
28	2.8	60	6.0	92	9.2	124	45.3
29	2.9	61	6.1	93	9.3	125	46.9
30	3.0	62	6.2	94	9.4	126	48.4
31	3.1	63	6.3	95	9.5	127	50.0

Table#5  
Delay Time(200.0ms)

Data	Value	Data	Value	Data	Value	Data	Value
0	0.1	32	50.5	64	100.8	96	151.2
1	1.7	33	52.0	65	102.4	97	152.8
2	3.2	34	53.6	66	104.0	98	154.4
3	4.8	35	55.2	67	105.6	99	155.9
4	6.4	36	56.8	68	107.1	100	157.5
5	8.0	37	58.3	69	108.7	101	159.1
6	9.5	38	59.9	70	110.3	102	160.6
7	11.1	39	61.5	71	111.9	103	162.2
8	12.7	40	63.1	72	113.4	104	163.8
9	14.3	41	64.6	73	115.0	105	165.4
10	15.8	42	66.2	74	116.6	106	166.9
11	17.4	43	67.8	75	118.2	107	168.5
12	19.0	44	69.4	76	119.7	108	170.1
13	20.6	45	70.9	77	121.3	109	171.7
14	22.1	46	72.5	78	122.9	110	173.2
15	23.7	47	74.1	79	124.4	111	174.8
16	25.3	48	75.7	80	126.0	112	176.4
17	26.9	49	77.2	81	127.6	113	178.0
18	28.4	50	78.8	82	129.2	114	179.5
19	30.0	51	80.4	83	130.7	115	181.1
20	31.6	52	81.9	84	132.3	116	182.7
21	33.2	53	83.5	85	133.9	117	184.3
22	34.7	54	85.1	86	135.5	118	185.8
23	36.3	55	86.7	87	137.0	119	187.4
24	37.9	56	88.2	88	138.6	120	189.0
25	39.5	57	89.8	89	140.2	121	190.6
26	41.0	58	91.4	90	141.8	122	192.1
27	42.6	59	93.0	91	143.3	123	193.7
28	44.2	60	94.5	92	144.9	124	195.3
29	45.7	61	96.1	93	146.5	125	196.9
30	47.3	62	97.7	94	148.1	126	198.4
31	48.9	63	99.3	95	149.6	127	200.0

Table#8  
Compressor Attack Time

Data	Value
0	1
1	2
2	3
3	4
4	5
5	6
6	7
7	8
8	9
9	10
10	12
11	14
12	16
13	18
14	20
15	23
16	26
17	30
18	35
19	40

Table#9  
Compressor Release Time

Data	Value
0	10
1	15
2	25
3	35
4	45
5	55
6	65
7	75
8	85
9	100
10	115
11	140
12	170
13	230
14	340
15	680

Table#10  
Compressor Ratio

Data	Value
0	1.0
1	1.5
2	2.0
3	3.0
4	5.0
5	7.0
6	10.0
7	20.0

Table#3  
EQ Frequency

# MIDI Implementation Chart

[Portable Keyboard]  
Model: PSR-8000

## MIDI Implementation Chart

Date: 08-SEP-1997  
Version: 1.0

Function	Transmitted	Recognized	Remarks	
Basic Channel	Default 1~16	*1 1~16	*2 1~16	
Mode	Default Messages Altered 3 X *****	3 X X		
Note Number	: True voice 0~127 *****	0~127 0~127		
Velocity	Note ON Note OFF	O 9nH, v=1~127 X 9nH, v=0	O 9nH, v=1~127 X	
After Touch	key's Ch's	X O	X O	
Pitch Bender		O	O	
Control Change	0, 32 1 5 7, 10, 11 6, 38 64~67 71, 74 72, 73 84 91, 93, 94 96,97 98,99 98,99 100,101 120 121	O O O O O O X *3 X *3 O O O O O O O O O O O O	O O O O O O O O O O O O O O O O O O O O	Bank Select Modulation Portamento Time  Data Entry  Sound Controller Sound Controller Portamento Controllers Effect Depth Data Inc, Dec RPN LSB, MSB NRPN LSB, MSB RPN LSB, MSB All Sound Off Reset All Controllers
Program Change	: True # O 0~127 *****	O 0~127	O 0~127	
System Exclusive		O	O	
System Common	: Song Position : Song Select : Tune	X X X	X X X	
System Real Time	: Clock : Commands	O O	O O	
Aux Messages	: Local ON/OFF : All Notes OFF : Active Sense : Reset	X X O X	X O (123~127) O X	

Mode 1 : OMNI ON, POLY  
Mode 3 : OMNI OFF, POLY

Mode 2 : OMNI ON, MONO  
Mode 4 : OMNI OFF, MONO

O : Yes  
X : No

## Notes

\*1 The tracks for each channel can be selected via the panel.  
See page 135 for more information.

\*2 The tone generator normally functions as a 16-channel multi-timbre tone generator in response to MIDI input. MIDI messages therefore do not normally affect the panel voices or other panel settings.

The MIDI messages listed below, however, do affect the panel voice, style, multi pad, and song settings.

- MIDI MASTER TUNE, XG System parameter MASTER TUNE
- XG System parameter TRANSPOSE
- System exclusive messages which change the REVERB, CHORUS or DSP EFFECT settings.
- XG MULTI EQ parameters

Also, MIDI messages affect the panel settings when one of the following MIDI reception modes is selected.

These modes can be selected via the panel functions (see page 136).

- LEAD, RIGHT1, RIGHT2, LEFT, KEYBOARD, ACMP RHYTHM1, ACMP RHYTHM2, ACMP BASS, ACMP CHORD1, ACMP CHORD2, ACMP PAD, ACMP PHRASE1, ACMP PHRASE2:

See "MIDI RECEIVE MESSAGES FOR INDIVIDUAL PARTS" below.

- **CHORD:**

The note on/off messages received at the channel(s) set to "CHORD" are recognized as the fingering for the accompaniment section. The chords to be detected depend on the fingering modes specified for the PSR-8000. The chords will be detected regardless of the accompaniment on/off and split point settings on the PSR-8000 panel.

- **ROOT:**

The note on/off messages received at the channel(s) set to "ROOT" are recognized as the bass notes for the accompaniment section. The bass notes will be detected regardless of the accompaniment on/off and split point settings on the PSR-8000 panel.

- **PANEL CONTROL:**

The note on/off messages control the panel function which is selected via the MIDI PANEL CONTROL page. See page 138.

- **VOCAL HARMONY:**

See "VOCAL HARMONY MIDI SPECIFICATIONS" below.

- **OFF:**

MIDI channel messages will not be received on the designated channel.

\*3 These Control Change Messages are not transmitted by PSR-8000 panel operation, but may be transmitted by AUTO ACCOMPANIMENT or SONG playback.

## MIDI RECEIVE MESSAGES FOR INDIVIDUAL PARTS

Receivable messages depend on the part.

MIDI reception parts Recognized	Panel voice					Accompaniment parts
	LEAD	RIGHT1	RIGHT2	LEFT	KEYBOARD	RHYTHM1 : PHRASE2
<b>Note</b>						
Note On/Off	○	○	○	○	○*1	○
<b>Control Changes</b>						
Bank Select MSB,LSB	○	○	○	○	×	○
Modulation	○	○	○	○	○*1	○
Portament Time	○	○	○	○	×	×
Volume	○	○	○	○	○*1	○
Expression	○	○	○	○	○*1	○
Pan	○	○	○	○	×	○
Sustain	○	○	○	○	○*1	×
Portament	○	○	○	○	×	×
Sostenute	○	○	○	○	○*1	×
Soft pedal	○	○	○	○	○*1	×
Harmonic Content	○	○	○	○	×	○
Release Time	○	○	○	○	×	○
Attkc Time	○	○	○	○	×	○
Brightness	○	○	○	○	×	○
Reverb Send Level	○	○	○	○	×	○
Chorus Send Level	○	○	○	○	×	○
Variation Send Level	○	○	○	○	×	○
Pitch Bend	○	○	○	○	○*1	○
Ch's After Touch	○	○	○	○	○*1	×
RPN FINE TUNE	○	○	○	○	×	×
RPN PITCH BEND SENSITIVITY	○	○	○	○	×	×
All notes off	○	○	○	○	○*1	○
<b>Program</b>						
Program Change	○	○	○	○	○*2	○
<b>XG MULTI PART Parameters</b>						
BANK SELECT MSB	○	○	○	○	×	○
BANK SELECT LSB	○	○	○	○	×	○
PROGRAM CHANGE NUMBER	○	○	○	○	○*2	○
MONO/POLY MODE	○	○	○	○	×	×
NOTE SHIFT	○	○	○	○	×	○
DETUNE	○	○	○	○	×	○
VOLUME	○	○	○	○	○	○
VELOCITY SENSE DEPTH	○	○	○	○	×	○
VELOCITY SENSE OFFSET	○	○	○	○	×	○
PAN	○	○	○	○	×	○
NOTE LIMIT LOW	×	×	×	×	×	×
NOTE LIMIT HIGH	×	×	×	×	×	×
DRY LEVEL	○	○	○	○	×	○
CHORUS SEND	○	○	○	○	×	○
REVERB SEND	○	○	○	○	×	○
VARIATION SEND	○	○	○	○	×	○
VIBRATO RATE	○	○	○	○	×	○
VIBRATO DEPTH	○	○	○	○	×	○
VIBRATO DELAY	○	○	○	○	×	○
FILTER CUTOFF FREQUENCY	○	○	○	○	×	○
FILTER RESONANCE	○	○	○	○	×	○
EG ATTACK TIME	○	○	○	○	×	○
EG DECAY TIME	○	○	○	○	×	○
EG RELEASE TIME	○	○	○	○	×	○

MIDI reception parts Recognized	Panel voice					Accompaniment parts
	LEAD	RIGHT1	RIGHT2	LEFT	KEYBOARD	RHYTHM1 : PHRASE2
MW PITCH CONTROL	○	○	○	○	×	○
MW FILTER CONTROL	○	○	○	○	×	○
MW AMPLITUDE CONTROL	○	○	○	○	×	○
MW LFO PMOD DEPTH	○	○	○	○	×	○
MW LFO FMOD DEPTH	○	○	○	○	×	○
MW LFO AMOD DEPTH	○	○	○	○	×	○
BEND PITCH CONTROL	○	○	○	○	×	○
BEND FILTER CONTROL	○	○	○	○	×	○
BEND AMPLITUDE CONTROL	○	○	○	○	×	○
BEND LFO PMOD DEPTH	○	○	○	○	×	○
BEND LFO FMOD DEPTH	○	○	○	○	×	○
BEND LFO AMOD DEPTH	○	○	○	○	×	○
Rev NOTE MESSAGE	×	×	×	×	×	×
SCALE TUNING C	○	○	○	○	×	○
SCALE TUNING C#	○	○	○	○	×	○
SCALE TUNING D	○	○	○	○	×	○
SCALE TUNING D#	○	○	○	○	×	○
SCALE TUNING E	○	○	○	○	×	○
SCALE TUNING F	○	○	○	○	×	○
SCALE TUNING F#	○	○	○	○	×	○
SCALE TUNING G	○	○	○	○	×	○
SCALE TUNING G#	○	○	○	○	×	○
SCALE TUNING A	○	○	○	○	×	○
SCALE TUNING A#	○	○	○	○	×	○
SCALE TUNING B	○	○	○	○	×	○
CAT PITCH CONTROL	○	○	○	○	×	×
CAT FILTER CONTROL	○	○	○	○	×	×
CAT AMPLITUDE CONTROL	○	○	○	○	×	×
CAT LFO PMOD DEPTH	○	○	○	○	×	×
CAT LFO FMOD DEPTH	○	○	○	○	×	×
CAT LFO AMOD DEPTH	○	○	○	○	×	×
PORTAMENTO SWITCH	○	○	○	○	×	×
PORTAMENTO TIME	○	○	○	○	×	×
EQ BASS	○	○	○	○	×	○
EQ TREBLE	○	○	○	○	×	○
EQ BASS frequency	○	○	○	○	×	○
EQ TREBLE frequency	○	○	○	○	×	○
<b>XG EFFECT1 Parameter</b>						
VARIATION PART	○	○	○	○	×	○
<b>XG EFFECT2 Parameters</b>						
INSERTION1 PART	○	○	○	○	×	○
INSERTION2 PART	○	○	○	○	×	○
INSERTION3 PART	○	○	○	○	×	○
INSERTION4 PART	○	○	○	○	×	○

Notes

\*1: The panels settings determine to which parts effects will be applied.

\*2: Program change numbers select Registration Memories. (0...127 = 8sw x 16bank)

## VOCAL HARMONY MIDI SPECIFICATIONS

### Channel message

			Harmony ch	Melody ch
1) Note on / off				
9n	kk vv	note on message	○	○
Specifies pitch in the Vocoder mode. Velocity not recognized. Also used as Gender Threshold source for the Melody channel.				
8n	kk vv	note off message	○	○
Turns the current note off in the Vocoder mode.				
9n	kk 00			
Also used as Gender Threshold source for the Melody channel.				
2) Control change				
Bn	40 vv	damper pedal	○	○
	64	RPN	○	○
	65	RPN	○	○
	62	NRPN	○	○
	63	NRPN	○	○
	06	Data entry MSB	○	○
	64	Data Increment	○	○
	26	Data Decrement	○	○
	7B	All note off	○	○
3) RPN				
MSB	LSB			
00	00	Pitch bend sensitivity	○	○
7F	7F	NULL	○	○
4) NRPN				
MSB	LSB			
00	00	Harmony mute	○	×
01	08	Vibrato rate modulation	○	○
01	09	Vibrato depth modulation	○	○
01	0A	Vibrato delay modulation	○	○
01	1A	Detune modulation	○	×
Controls the overall amount of detune.				
02	10	Harmony 1 volume	○	×
02	11	Harmony 2 volume	○	×
02	20	Harmony 1 pan	○	×
02	21	Harmony 2 pan	○	×
02	30	Harmony 1 detune	○	×
02	31	Harmony 2 detune	○	×
03	00	Lead gender type	×	○
03	01	Lead gender amount	×	○
5) Pitch bend				
E0	nn nn		○	○
Only effective when melody channel Lead Gender ON.				

# Audio Sampling Library CD Contents

## ▪ Black II Black 1 and 2

### — Steve McIntosh & Joe Charles

Track1 .....  
 Chalis Loop - 71 bpm  
 SUB - 84 bpm  
 Slow Jamz - 85 bpm

Track2 .....  
 Kool Jamz II Loop - 90 bpm  
 Laid Black Loop - 90 bpm  
 Kickin - 93 bpm  
 Rub'n'Roll Loop - 93 bpm  
 The Hood - 93 bpm  
 Urban Jamz Loop - 93 bpm  
 Deep Grine - 94 bpm

Track3 .....  
 R-Beat - 104 bpm  
 Alarming Loop - 105 bpm  
 Voice Loop - 105 bpm  
 Gangstar - 106 bpm  
 Mad Dog - 106 bpm  
 Indian Snare - 107 bpm

Track4 .....  
 Bizzee House Loop - 120 bpm  
 Drive Loop - 120 bpm  
 Rubberband Loop - 125 bpm

Track5 .....  
 Black Snare  
 Tite Black Snare  
 Dance Hall Snare  
 HipHop Snare  
 HiSwing Snare  
 Ruff Snare  
 Black Kick  
 Ruff Kick

Track6 .....  
 Ooops!  
 Scratch it Roll  
 Booty Scratch  
 \*Deep Black Electro  
 Good Vinyl

\* More samples from McIntosh & Charles are available on "Black II Black 1", "Black II Black 2" Sample CDs (AMGCDS1, AMGCDS2) and CD-ROMs (AMGCDRS1, AMGCDRS2) from AMG. Volume 3 and further releases are planned for 1997.

\* They also produced the hugely successful "Killer Vocals" Volume 1-3 also from AMG.

## ▪ Black II Black Volume 3

### — Steve McIntosh & Joe Charles

Track7 .....  
 Retro Swing - 94 bpm  
 Thruster Jam - 105 bpm  
 Millennium Jam - 96 bpm  
 Rebel Jam - 102 bpm

Track8 .....  
 College Jam - 138 bpm  
 Percussive Flava 1 - 138 bpm  
 Perc Flava - 94 bpm  
 School Hip-Hop - 98 bpm

Track9 .....  
 \*Electro Jamz - 87 bpm  
 Ricochet Jam - 100 bpm  
 Perc Flava 3 - 108 bpm  
 Perc Flava 2 - 86 bpm  
 Perc Flava 4 - 93 bpm  
 Glynn Jamz - 94 bpm

\* More samples from Black II Black are available on "Black II Black 1", "Black II Black 2" Sample CDs (AMGCDS1, AMGCDS2) and CD-ROMs (AMGCDRS1, AMGCDRS2) from AMG. Volume 3 and further releases are planned for 1997.

\* They also produced the hugely successful "Killer Vocals" Volume 1-3 also from AMG.

## ▪ Tony Mason...Smokin'

Track10 .....  
 Make Up - 89 bpm  
 Love is Great - 98 bpm  
 Approved - 80 bpm

Track11 .....  
 Slow Vibe - 64 bpm  
 The Pocket - 70 bpm

\* More samples from Tony Mason are available on his "Tony Mason...Smokin'" Sample CD (AMGCD24) and ReCycled CD-ROM (AMGCDR24) from AMG.

## ▪ Groove Activator — Gota Yashiki

Track12 .....  
 Junior 1 - 104 bpm  
 Arms 1 - 88 bpm

Track13 .....  
 Sunrise - 96 bpm A  
 Sunrise - 96 bpm C

Track14 .....  
 Hottest - 88 bpm A  
 Hottest - 88 bpm B  
 Hottest - 88 bpm C  
 Hottest - 88 bpm D  
 Hottest - 88 bpm E  
 Hottest - 88 bpm F

Track15 .....  
 Thrill 1 - 97 bpm  
 Riding 1 - 117 bpm

\* More samples from Gota Yashiki are available on his "Groove Activator" Sample CD (AMGCD21) and ReCycled CD-ROM (AMGCDR21) from AMG.

## ▪ Pascal Gabriel's Dance Samples

Track16 .....  
 Wow+Flutter - 90 bpm  
 Pulse - 92 bpm  
 Enormous - 93 bpm  
 Filth - 93 bpm  
 Perc Snatch - 93 bpm  
 Rounded Break - 99 bpm

Track17 .....  
 Thippy Perc - 104 bpm  
 Top End Filth - 104 bpm  
 Shuff'o God - 106 bpm  
 Gated Swing - 107 bpm  
 Spaced Out - 108 bpm  
 Spaced Intro - 108 bpm  
 Swaying - 108 bpm

Track18 .....  
 Perc Trill - 110 bpm  
 Infamous - 112 bpm  
 Clipped! - 114 bpm  
 Scratch Break - 114 bpm  
 6 Scratch - 115 bpm

Track19 .....  
 60s Intro - 116 bpm  
 Big Conga Intro - 116 bpm  
 Big Conga Loop - 116 bpm  
 Car Start - 116 bpm  
 Add Kick+Snare - 118 bpm  
 Gyrabreak 1 - 118 bpm  
 Gyrabreak 2 - 118 bpm  
 Gyrabreak 3 - 118 bpm

Track20 .....  
 House Stomp - 120 bpm  
 Lounge House - 121 bpm  
 D.I.S.C.O. - 122 bpm  
 League - 128 bpm  
 Logalimba - 135 bpm  
 Manic Bongo - 135 bpm  
 Balearic - 137 bpm

Track21 .....  
 Big Doo  
 Samplespeed

\* More samples from Pascal Gabriel are available on his "Dance Samples" Sample CD (HITCD08), "Colourful World of Sounds & Silence" Sample CD (AMGCD23), and ReCycled "Loop Soup" CD-ROM (LSCDR1) all from AMG.

## ▪ Deep Inside — Tim Farriss

Track22 .....  
 Hipster - 110 bpm  
 Booga - 114 bpm  
 \*Loop - 116 bpm  
 \*FX Loop 1 - 124 bpm  
 \*FX Loop 2 - 124 bpm  
 Tribal - 135 bpm

Track23 .....  
 \*Broke  
 \*Tear 1  
 \*Tear 2  
 Crackin' Snare  
 Exploso  
 Expo Kick  
 Expo Snare  
 \*Whistle  
 Call 2 Prayer

\* More samples from Tim Farriss are available on his "Deep Inside" Sample CD (TFCDXS1) from AMG.

## ▪ Kickin' Lunatic Beats Volume 1 — Keith LeBlanc

Track24 .....  
 Kickin'Fill  
 Kickin'Swing A - 100 bpm  
 Kickin'Swing B - 100 bpm

Track25 .....  
 Positive - 100 bpm A  
 Positive - 100 bpm B  
 Positive - 100 bpm C

Track26 .....  
 Closed Hat 1  
 Closed Hat 2  
 Closed Hat 3  
 Closed Hat 4  
 Closed Hat 5  
 Open Hat 1  
 Open Hat 2

Track27 .....  
 Bell  
 China 1  
 China 2  
 Crash 1  
 Crash 2  
 Ride  
 Splash

Track28 .....  
 Kick  
 Snare  
 Tom 1  
 Tom 2  
 Tom 3  
 Tom 4

\* More samples from Keith LeBlanc are available on his "Kickin' Lunatic Beats Volume 1", "Kickin' Lunatic Beats Volume 2" Sample CDs (HITCD17, KLBCD2) and ReCycled CD-ROM (KLBCDR2) from AMG. More releases from Keith LeBlanc are planned for 1997.

## ▪ Kickin' Lunatic Beats Volume 2 — Keith LeBlanc

Track29 .....  
 Kill Beat - 158 bpm  
 Funky Dub Pt.2 - 77 bpm

\* More samples from Keith LeBlanc are available on his "Kickin' Lunatic Beats Volume 1", "Kickin' Lunatic Beats Volume 2" Sample CDs (HITCD17, KLBCD2) and ReCycled CD-ROM (KLBCDR2) from AMG. More releases from Keith LeBlanc are planned for 1997.

## ▪ Ian Curnow & Phil 'Mixmaster' Harding

Track30 .....  
 Euro Bass A  
 Euro Bass B  
 Euro Bass C  
 Soft&Fat Bass A  
 Soft&Fat Bass B  
 Soft&Fat Bass C

Track31 .....  
 \*Super Bass A  
 \*Super Bass B  
 \*Super Bass C  
 Useful Bass A  
 Useful Bass B  
 Useful Bass C

Track32 .....  
 Basia Kick 1  
 Basia Kick 2  
 Dance Kick  
 Rock Kick  
 Machine Kick  
 SAW Kick

Track33 .....  
 Clanky Snare  
 Lil'Snare  
 SAW Snare  
 Tekno Snare  
 Tinny Snare

\* These samples were created for a proposed AMG Sample CD that was never released.

## ▪ Funky Drums from Hell — Neil Conti

Track34 .....  
 Continuity 1 - 80 bpm  
 Continuity 2 - 80 bpm

Track35 .....  
 Bread Loop A - 84 bpm  
 Bread Loop B - 84 bpm  
 Bread Loop C - 84 bpm  
 Bread Loop D - 84 bpm  
 Bread Loop E - 84 bpm

Track36 .....  
 Hooper Looper A - 88 bpm  
 Hooper Looper B - 88 bpm  
 Hooper Looper C - 88 bpm  
 Hooper Looper D - 88 bpm  
 Tick Tock Groove 1 - 90 bpm  
 Tick Tock Groove 2 - 90 bpm

Track37 .....  
 I know U do Groove A - 96 bpm  
 I know U do Groove B - 96 bpm  
 I know U do Groove C - 96 bpm  
 I know U do Groove D - 96 bpm  
 I know U do Groove E - 96 bpm  
 I know U do Groove F - 96 bpm



- Track37 .....  
 Monsterous Loop A - 98 bpm  
 Monsterous Loop B - 98 bpm  
 Monsterous Loop C - 98 bpm  
 Monsterous Loop D - 98 bpm  
 Monsterous Loop E - 98 bpm  
 Monsterous Loop F - 98 bpm

- Track38 .....  
 LA Groove A - 118 bpm  
 LA Groove B - 118 bpm  
 LA Groove C - 118 bpm  
 LA Groove D - 118 bpm  
 LA Groove E - 118 bpm

\* More samples from Neil Conti are available on his "Funky Drums from Hell" Sample CD (AMGCD14) and CD-ROM (AMGCDR14) from AMG.

## ■ Drumhead — Preview

- Track39 .....  
 Live Drum - 110 bpm  
 Conga Loop - 100 bpm  
 Open Snare 1 - 112 bpm  
 Open Snare 2 - 112 bpm

- Track40 .....  
 Funky Ambient - 120 bpm  
 Funky Ambient 2 - 96 bpm  
 Rock Fill - 91 bpm  
 Rock Groove - 91 bpm

\* More samples from Drumhead are available on the AMG Sample CD scheduled for release during 1997.

## ■ Karma Chopra — Sumeet Chopra

- Track41 .....  
 Dumbereki - 106 bpm  
 Swami Groove - 121 bpm  
 Sitar Octave - 124 bpm  
 Response - 127 bpm  
 Soggy Guiro - 128 bpm  
 Tablas - 131 bpm  
 Dholak Break - 132 bpm  
 Metal Tablas - 148 bpm

- Track42 .....  
 Bhangra Crash  
 Bhangra Open Hat  
 Bhangra Closed Hat  
 Bhangra Kick1  
 Bhangra Kick2  
 Bhangra Kick3  
 Bhangra Snare1  
 Bhangra Snare2  
 Bhangra Snare3  
 1-2-3 Drop!

\* More samples from Sumeet Chopra are available on his "Karma Chopra" Sample CD (AMGCD54) from AMG.

## ■ Art of Sampling — Art of Noise's JJ Jeczalik

- Track43 .....  
 Ambient Bongo Loop - 94 bpm  
 Ambient Bongo Trill - 94 bpm  
 Conga - 94 bpm  
 Shaker - 107 bpm

- Track44 .....  
 Oil Tank 1  
 Oil Tank 2  
 Oil Tank 3  
 Oil Tank 4

- Track45 .....  
 \*Guitar Comp note  
 Guitar Stab  
 \*Guitar Wah note  
 Electro Hat Closed  
 Electro Hat Open

\* More samples from JJ Jeczalik are available on his "Art of Sampling" Sample CD (HITCD12) from AMG.

## ■ Skip to my Loops — Norman Cook

- Track46 .....  
 Busy Esta  
 \*Conga  
 House Limbo  
 Old Skool Vibe  
 Tom Cat Bossa  
 \*Percussion Loop 1  
 \*Percussion Loop 2
- Track47 .....  
 \*Loop  
 Soulful Samba  
 Soul 2 Scales  
 Tasty Sin  
 Toy Drums  
 \*Loop  
 Splat 3  
 Sun Shine

- Track48 .....  
 Elementary Hats  
 Nitrate  
 Stalag Phil  
 Straight Drums  
 Wayne 1  
 \*Wah Wah Guitar

- Track49 .....  
 More Music  
 Ohohoa  
 Stab 1  
 Stab 2  
 Kick 1  
 Kick 2  
 Radio

\* More samples from Norman Cook are available on his "Skip to my Loops" Sample CD (HITCD11) and ReCycled "Loop Soup!" CD-ROM (LSCDR1) from AMG.

## ■ Rhythm of Life 1 — Danny Cummings & Miles Bould

- Track50 .....  
 Cold Sweat 1A - 91 bpm  
 Cold Sweat 1B - 91 bpm  
 Cold Sweat 1C - 91 bpm  
 Cold Sweat 2 - 91 bpm  
 Cold Sweat Batta - 91 bpm  
 Cold Sweat Conga - 91 bpm  
 Cold Sweat Djembe - 91 bpm  
 Cold Sweat Udu & Batta - 91 bpm

- Track51 .....  
 Berimbau  
 Hand Gong  
 M.Vibraslap  
 Spring Hit  
 Udu Lo 1  
 Udu Lo 2  
 Udu Lo 3  
 Udu Lo Open  
 Udu+Bend 1  
 Udu+Bend 2

- Track52 .....  
 Udu Hand Hit 1  
 Udu Hand Hit 2  
 Udu Lo Mute 1  
 Udu Lo Mute 2  
 Udu Side Slap 1  
 Udu Side Slap 2  
 Udu Side Slap 3  
 Udu Side Slap 4  
 Udu Side Wobble  
 Udu Slap+Bend  
 Udu Wobble L  
 Udu Wobble S

\* More samples from Danny Cummings & Miles Bould are available on their "Rhythm of Life 1" Sample CD (HITCD07) and CD-ROM (HITCDR07) from AMG.

## ■ Abracatabla — Tavin Singh

- Track53 .....  
 Swinging Singh (Mix 1) - 100 bpm

\* More samples from Tavin Singh are available on his "Abracatabla" Sample CD (AMGCD25) and ReCycled CD-ROM (AMGCDR25) from AMG.

## ■ Global Trance Mission Vols 1&2 — Garry Hughes & Nick Fisher

- Track54 .....  
 Trippy Seq E - 98 bpm  
 Dreamseq Am 3 - 99 bpm  
 Dreamseq Am 4 - 99 bpm  
 \*Oct C - 119 bpm  
 Drive Seq 1-G - 123 bpm  
 Drive Seq 2-G - 123 bpm  
 Soft Rave Seq - 124 bpm  
 Orange Nightmare B - 126 bpm  
 \*St.Noise - 131 bpm  
 \*Teknoise Seq
- Track55 .....  
 Off World Colonies  
 Mission Control

\* More samples from Garry Hughes & Nick Fisher are available on two Sample Capsules "Global Trance Mission Volumes 1 & 2" (AMGCD19A/B) and two forthcoming ReCycled CD-ROMs from AMG. A new volume is planned for 1997.

## ■ Old Gold Synth

- Track56 .....  
 \*Trip Seq  
 Mono Trip Seq  
 \*Sequence  
 \*S/H Seq  
 \*Riff Seq 1  
 \*Riff Seq 2  
 \*Riff Seq 3

\* More Old Gold Synth samples are available on the "Old Gold Synth" Sample CD (HITCD02) from AMG.

## ■ Pure Gold Synth

- Track57 .....  
 \*S&H Pad 1  
 \*S&H Pad 2  
 \*S&H Pad 3  
 LisTen Pad C2  
 LisTen Pad C3  
 LisTen Pad C4
- Track58 .....  
 Lo Rezo C2  
 Lo Rezo A#2  
 Lo Rezo G#3  
 Sync it

\* More Pure Gold Synth samples were available on the "Pure Gold Synth" Sample CD (HITCD01) from AMG that is now deleted.

## ■ Lucky Bastard — Erasure's Vince Clarke

- Track59 .....  
 Electro Juice  
 Insectalk  
 Jumping Jaks  
 Lite X-mod  
 Mondohips  
 Pulsar Bass  
 Subotnoise  
 Syncropate  
 Woozy X-mod  
 Arcade  
 Creatures  
 Drippy X-mod  
 Fizzle Out!  
 \*Mute  
 Pulse Base  
 Teknolaugh

\* More samples from Vince Clarke are available on his "Lucky Bastard" Sample CD (HITCD16) from AMG.

## ■ Terminalhead — Preview

- Track60 .....  
 Synth Fx Sequences 1-3  
 Perc 1-3  
 Alien FX 1-2
- Track61 .....  
 Hard Synth FX 1-3  
 Syn Atmos  
 Synth FX 1-3

- Track62 .....  
 Guitar FX 1-8  
 Synth FX Sequences 4-8

\* More samples from Terminalhead are available on the AMG Sample CDs scheduled for release during 1997.

## ■ Sample + Hold — Preview by metaldog

- Track63 .....  
 4 Analog Adventures  
 4 more Analog Adventures  
 Final 4 Analog Adventures

\* More Sample + Hold samples from metaldog are available on the AMG Sample CD scheduled for release during 1997.

## ■ The Beatmasters — Preview

- Track64 .....  
 Synth Samples  
 Misc. Samples
- Track65 .....  
 Loop Samples  
 Bass Samples

\* More samples from The Beatmasters are available on the AMG Sample CD scheduled for release during 1997.

## ■ AcouSticks!

- Track66 .....  
 16 Beat - 128 bpm
- Track67 .....  
 8 Beat 1 - 120 bpm  
 8 Beat 2 - 115 bpm  
 8 Beat 3 - 108 bpm
- Track68 .....  
 8 Beat 4 - 76bpm  
 8 Beat 5 - 132bpm

# Audio Sampling Library CD Contents

Track69 .....	Disco 1 - 128 bpm
	Disco 2 - 128 bpm
	Disco 3 - 128 bpm
Track70 .....	HipHop 1 - 98 bpm
	HipHop 2 - 98 bpm
	HipHop 3 - 98 bpm
Track71 .....	HipHop 4 - 105 bpm
	HipHop 5 - 105 bpm
	HipHop 6 - 105 bpm
Track72 .....	HipHop 7 - 101 bpm
	HipHop 8 - 101 bpm
Track73 .....	HipHop 9 - 88bpm
	HipHop 10 - 89bpm
Track74 .....	Reggae 1 - 100 bpm
	Reggae 2 - 100 bpm
Track75 .....	Rock 1 - 120 bpm
	Rock 2 - 128 bpm
	Rock 3 - 120 bpm
Track76 .....	Shuffle 1 - 120 bpm
	Shuffle 2 - 120 bpm

## More AcouSticks!

Track77 .....	8 Beat 1 - 136 bpm
	8 Beat 2 - 136 bpm
	8 Beat 3 - 136 bpm
	8 Beat 4 - 84 bpm
Track78 .....	16 Beat 1 - 136 bpm
	16 Beat 2 - 120 bpm
	16 Beat 3 - 108 bpm
	16 Beat 4 - 108 bpm
	16 Beat 5 - 96 bpm
	16 Beat 6 - 96 bpm
	16 Beat 7 - 74 bpm
	24 Beat - 65 bpm

## Ethnic Percussion Loop

Track79 .....	Percussion Loop 1 - 82 bpm
	Percussion Loop 2 - 116 bpm
	Percussion Loop 3 - 102 bpm
	Percussion Loop 4 - 104 bpm
	Percussion Loop 5 - 86 bpm
	Percussion Loop 6 - 91 bpm
	Percussion Loop 7 - 131 bpm
	Percussion Loop 8 - 130 bpm
	Percussion Loop 9 - 147 bpm

## Extremes

Track80 .....	Bellgroove 1 (fat) - 100 bpm
	Bellgroove 2 (thin) - 101 bpm
	Dirty 1 - 104 bpm
	Dirty 2 - 104 bpm
	Noisy - 107 bpm
	Pavement Beat - 104 bpm
Track81 .....	Jangly 1 - 111 bpm
	Jangly 2 (kick) - 111 bpm
	Jangly 3 (hard) - 111 bpm
	Heavy 1 (sub) - 103 bpm
	Heavy 2 (twist) - 103 bpm
Track82 .....	QuikDub 1 (Hi) - 110 bpm
	QuikDub 2 (Lo) - 110 bpm
	Ruff 1 - 99 bpm
	Ruff 2 (Kick) - 99 bpm
	Ruff 3 (SnareGate) - 100 bpm

## Escola de Samba

Track83 .....	Samba - 137bpm
	Samba+Cuica - 137bpm
	Samba Fill 1 - 137bpm
	Samba Fill 2 - 137bpm
	Samba Fill 3 - 137bpm
	Apito

## Sound Effects (Voices)

Track84 .....	Laughter 1
	Laughter 2
	Laughter (comical)
	Laughter (applause)
	Anger
	Anger (female)
	Booing
	Cheering 1
	Cheering 2
	Cheering on
	Blue Jay
	Hawk
	Eagle
	Loon
Track85 .....	Shout (female)
	Surprise (male)
	Surprise (female)
	Karate
	Sigh (female)
	Breathing
Track86 .....	Halloo!
	Yee-hah!
	What?
	Wow!
	Hey!
	No!
	Whoops!
Track87 .....	Baby (laughing)
	Baby (crying)
	Applause (sparse)
	Applause (hearty)

## Sound Effects (Noises)

Track88 .....	Punch (light)
	Punch (heavy)
	Footsteps (leather shoes)
	Door (open and close)
	Jail door (open and close)
Track89 .....	Camera (shutter)
	Camera (instant)
	Stopwatch (ticking)
	Telephone (ringing)
	Telephone (ringing signal)
	Telephone (busy signal)
	Beer (bottle of beer)

## Sound Effects (Sports)

Track90 .....	Basketball
	Volleyball
	Golf (swing)
	Golf (into the hole)
	Bowling
	Tennis
	Squash
	Badminton
Track91 .....	Fencing
	Billiards
	Curling
	Archery
	Darts
	Swimming
	Swimming (dive in)
	Skating

## Sound Effects (Vehicles)

Track92 .....	Start engine 1
	Start engine 2
	Car horn
	Car door open and shut
	Passing
	F1 racing
	Tire squealing
	Slam on the brakes
	Motorcycle (start engine)
	Motorcycle (passing)
	Motorcycle (racing)
	Bicycle horn

Track93 .....	Train (clickety-clack)
	Train (passing)
	Cessna (passing)
	Dual propeller (passing)
	Jet (passing)
	Helicopter (passing)
	Helicopter (hovering)
	Boat (passing)
	Boat (steam horn)

## Sound Effects (Big Noises)

Track94 .....	Gun
	Shotgun
	Machine gun
	Artillery
	Cannon
	Explosion 1
	Explosion 2
Track95 .....	Car crash 1
	Car crash 2
	Glass breaking 1
	Glass breaking 2
	Fire (fireplace)
	Fire (forest fire)
	Crushing
	Slam
Track96 .....	Pneumatic hammer
	Pile driver
	Chain saw

## Sound Effects (Nature)

Track97 .....	Rain (light rain)
	Rain (heavy rain)
	Thunder
	Thundershower
	Wind
	Wind (storm)
	Ocean (small waves)
	Ocean (large waves)
	Jungle
	Dripping (cave)

## Sound Effects (Fun)

Track98 .....	Space
	Space ("byonggg")
	Space (takeoff)
	Space (departing)
	Space (laser gun)
Track99 .....	Byonggg 1
	Byonggg 2
	Byonggg 3
	Byonggg 4
	Whistle
	Swoosh-thud
	Siren whistle

<Notes>

- Produced by AMG. All other samples produced by Yamaha.
- ♦ Produced by AMG, renamed by Yamaha.

All samples have been converted to mono for easier sampling with the PSR-8000.

This CD features samples from the World's foremost sample developer  
**AMG**

Phone - UK (0)+1252 717333

Fax - UK(0)+1252 737044

e-mail - [matt@amguk.demon.co.uk](mailto:matt@amguk.demon.co.uk)

WWW - <http://www.soundcheck.co.uk/soundcheck/>

Contact AMG for more information on AMG Sample CDs, CD-ROMs, your local distributor or to join our e-mail info service.

Unauthorized reselling, copying, hiring, renting, public performance and broadcasting of this CD is prohibited. Purchase of this product entitles the purchaser to use the audio material featured in their music, not for the creation of any competitive product.

# Specifications

## KEYBOARD:

61 Keys (C1-C6)  
with Touch Response (Initial/After)

## POLYPHONY:

64 Notes max.

## VOICES:

261 Original voices  
480 XG voices  
13 Drum/SFX kits  
Organ Flute  
Custom voice area:  
32 (User Programmable)

## ACCOMPANIMENT:

Accompaniment styles:  
Preset 214 + Disk 25 styles

Auto Accompaniment:  
Single Finger/Multi Finger/  
Fingered 1/Fingered 2/Full Keyboard/  
Manual Bass

Virtual Arranger

Groove Style area:  
20 (User Programmable)

Custom Style area:  
16 (User Programmable)

## ONE TOUCH SETTING:

4 settings are available  
for each preset style  
Custom OTS area:  
4 setups x 8 styles  
(User Programmable)

## EFFECT & CONTROLLER:

EFFECT:  
Reverb (24 types + 3 User types)  
Chorus (20 types + 3 User types)  
DSP for Style (98 types)  
DSP for Lead  
(78 types + 10 User types)  
DSP for Right 1  
(78 types + 10 User types)  
DSP for Right 2  
(78 types + 10 User types)  
DSP for Mic  
(78 types + 10 User types)  
Vocal Harmony  
(50 types + 3 User types)  
5-band Master Equalizer  
(2 types + 2 User types)

Harmony/Echo 14 types

Mixing Console  
Left Hold  
Pitch Bend Wheel  
Modulation Wheel

## SAMPLING:

1MB wave RAM memory  
44.1 kHz sampling  
File Import

### WAVE EDIT:

Resampling, Loop Point, Normalize,  
Volume/Tune, Wave Name, Clear,  
Export as WAV, Delete

### WAVEFORM EDIT:

Add Wave, Move Start Note/Volume/  
Delete Wave, Waveform Name,  
Clear, Save, Delete, Store as Custom  
Voice

## MULTI PAD:

Preset: 50 banks x 4 setups  
User Programmable area:  
10 banks x 4 setups

## SONG RECORD:

### Quick Record:

Manual/Accompaniment Tracks  
Chord Step Record,  
Edit (Rename, Delete)

### Multi Track Record:

1~16 Tracks  
Replace, Punch In, Edit (Rename,  
Quantize, Track Mix, Note Shift,  
Song Delete), Setup

## SONG PLAY:

Single, All, Random, Next Song, Song  
Order, Repeat, Lyric Display, REW, FF,  
PAUSE

## REGISTRATION MEMORY:

16 banks x 8 setups, Freeze

## HELP FUNCTION:

Five languages  
(English, German, French, Spanish  
and Italian)

## DISPLAY:

LCD (240 x 320 dots)

## DISK:

Load from Disk, Save to Disk, Copy File/  
FD, Change Song Order, Rename File/  
Song, Delete File/Song, Format Floppy  
Disk, Edit Directory, Format Hard Disk,  
Check Hard Disk

\* 3.5" FDD (2DD/2HD), Compatible with  
General MIDI (SMF format 0 and 1), XG, XF,  
DOC and SFF (Yamaha Style File Format)  
software.

## FUNCTIONS:

F1: Master Tune/Scale  
F2: Split Point/Fingering  
F3: Controller  
F4: Registration/One Touch Setting/  
Voice Set  
F5: Harmony/Echo  
F6: Customize List  
F7: Talk Setting  
F8: Utility  
F9: MIDI

## DEMONSTRATIONS:

21 Songs

## CONNECTORS:

MIDI (IN/OUT/THRU), AUX IN/LOOP  
RETURN (R, L/L+R, TRIM), LOOP  
SEND (R, L/L+R), AUX OUT (R, L/L+R),  
TO HOST, FOOT PEDAL (SWITCH 1/2,  
VOLUME), AC INLET, PHONES, MIC/  
LINE IN

## AMPLIFIER:

20W x 2

## SPEAKERS:

16cm x 2, 5cm x 2

## DIMENSIONS (W x H x D):

1058 mm x 178 mm x 446 mm  
(41-2/3" x 7" x 17-1/2")

## WEIGHT:

16.0 kg (35 lbs. 4 oz)

## SUPPLIED ACCESSORIES:

- AC Power Cord
- AC Plug Adaptor  
(in applicable areas only)
- Music Stand
- Audio CD  
(includes sound sources for sampling)
- Floppy Disk  
(includes accompaniment style files)
- Owner's Manual

## OPTIONAL ACCESSORIES:

- Foot Switch FC5
- Foot Volume FC7
- Headphones HPE-150
- Keyboard Stand L-7
- Hard Disk
- SIMM (4, 8, or 16MB x 2)

• Specifications and descriptions in this owner's manual are for information purposes only. Yamaha Corp. reserves the right to change or modify products or specifications at any time without prior notice. Since specifications, equipment or options may not be the same in every locale, please check with your Yamaha dealer.

# FCC INFORMATION (U.S.A.)

## 1. IMPORTANT NOTICE: DO NOT MODIFY THIS UNIT!

This product, when installed as indicated in the instructions contained in this manual, meets FCC requirements. Modifications not expressly approved by Yamaha may void your authority, granted by the FCC, to use the product.

## 2. IMPORTANT:

When connecting this product to accessories and/or another product use only high quality shielded cables. Cable/s supplied with this product MUST be used. Follow all installation instructions. Failure to follow instructions could void your FCC authorization to use this product in the USA.

## 3. NOTE:

This product has been tested and found to comply with the requirements listed in FCC Regulations, Part 15 for Class "B" digital devices. Compliance with these requirements provides a reasonable level of assurance that your use of this product in a residential environment will not result in harmful interference with other electronic devices. This equipment generates/uses radio frequencies and, if not installed and used according to the instructions found in the users manual, may cause interference harmful to the operation of other electronic devices. Compliance with FCC

regulations does not guarantee that interference will not occur in all installations. If this product is found to be the source of interference, which can be determined by turning the unit "OFF" and "ON", please try to eliminate the problem by using one of the following measures:

Relocate either this product or the device that is being affected by the interference.

Utilize power outlets that are on different branch (circuit breaker or fuse) circuits or install AC line filter/s.

In the case of radio or TV interference, relocate/reorient the antenna. If the antenna lead-in is 300 ohm ribbon lead, change the lead-in to co-axial type cable.

If these corrective measures do not produce satisfactory results, please contact the local retailer authorized to distribute this type of product. If you can not locate the appropriate retailer, please contact Yamaha Corporation of America, Electronic Service Division, 6600 Orangethorpe Ave, Buena Park, CA90620

The above statements apply ONLY to those products distributed by Yamaha Corporation of America or its subsidiaries.

\* This applies only to products distributed by YAMAHA CORPORATION OF AMERICA.

**CAUTION:** TO PREVENT ELECTRIC SHOCK, MATCH WIDE BLADE OF PLUG TO WIDE SLOT, FULLY INSERT.

**ATTENTION:** POUR ÉVITER LES CHOCS ÉLECTRIQUES, INTRODUIRE LA LAME LA PLUS LARGE DE LA FICHE DANS LA BORNE CORRESPONDANTE DE LA PRISE ET POUSSER JUSQU'AU FOND.

- This applies only to products distributed by Yamaha Canada Music Ltd.
- Ceci ne s'applique qu'aux produits distribués par Yamaha Canada Musique Ltée.

## IMPORTANT NOTICE FOR THE UNITED KINGDOM

### Connecting the Plug and Cord

IMPORTANT. The wires in this mains lead are coloured in accordance with the following code:

BLUE : NEUTRAL  
BROWN : LIVE

As the colours of the wires in the mains lead of this apparatus may not correspond with the coloured markings identifying the terminals in your plug proceed as follows:

The wire which is coloured BLUE must be connected to the terminal which is marked with the letter N or coloured BLACK.

The wire which is coloured BROWN must be connected to the terminal which is marked with the letter L or coloured RED.

Making sure that neither core is connected to the earth terminal of the three pin plug.

- This applies only to products distributed by Yamaha-Kemble Music (U.K.) Ltd.

## OBSERVERA!

Apparaten kopplas inte ur växelströmskällan (nätet) så länge som den är ansluten till vägguttaget, även om själva apparaten har stängts av.

**ADVASEL:** Netspændingen til dette apparat er IKKE afbrudt, så længe netledningen sidder i en stikkontakt, som er t endt — også selvom der er slukket på apparatets afbryder.

**VAROITUS:** Laitteen toisiopiiriin kytketty käyttökytkin ei irroita koko laitetta verkosta.

## Entsorgung leerer Batterien (nur innerhalb Deutschlands)

Leisten Sie einen Beitrag zum Umweltschutz. Verbrauchte Batterien oder Akkumulatoren dürfen nicht in den Hausmüll. Sie können bei einer Sammelstelle für Altbatterien bzw. Sondermüll abgegeben werden. Informieren Sie sich bei Ihrer Kommune.

For details of products, please contact your nearest Yamaha or the authorized distributor listed below.

Pour plus de détails sur les produits, veuillez-vous adresser à Yamaha ou au distributeur le plus proche de vous figurant dans la liste suivante.

Die Einzelheiten zu Produkten sind bei Ihrer unten aufgeführten Niederlassung und bei Yamaha Vertragshändlern in den jeweiligen Bestimmungsländern erhältlich.

Para detalles sobre productos, contacte su tienda Yamaha más cercana o el distribuidor autorizado que se lista debajo.

## NORTH AMERICA

### CANADA

**Yamaha Canada Music Ltd.**  
135 Milner Avenue, Scarborough, Ontario,  
M1S 3R1, Canada  
Tel: 416-298-1311

### U.S.A.

**Yamaha Corporation of America**  
6600 Orangethorpe Ave., Buena Park, Calif. 90620,  
U.S.A.  
Tel: 714-522-9011

## CENTRAL & SOUTH AMERICA

### MEXICO

**Yamaha de Mexico S.A. De C.V.,**  
Departamento de ventas  
Javier Rojo Gomez No.1149, Col. Gpe Del  
Moral, Deleg. Iztapalapa, 09300 Mexico, D.F.  
Tel: 686-00-33

### BRASIL

**Yamaha Musical do Brasil LTDA.**  
Ave. Reboucas 2636, São Paulo, Brasil  
Tel: 011-853-1377

### ARGENTINA

**Yamaha Music Argentina S.A.**  
Viamonte 1145 Piso2-B 1053,  
Buenos Aires, Argentina  
Tel: 1-371-7021

### PANAMA AND OTHER LATIN AMERICAN COUNTRIES/ CARIBBEAN COUNTRIES

**Yamaha de Panama S.A.**  
Torre Banco General, Piso 7, Urbanización Marbella,  
Calle 47 y Aquilino de la Guardia,  
Ciudad de Panamá, Panamá  
Tel: 507-269-5311

## EUROPE

### THE UNITED KINGDOM

**Yamaha-Kemble Music (U.K.) Ltd.**  
Sherbourne Drive, Tilbrook, Milton Keynes,  
MK7 8BL, England  
Tel: 01908-366700

### IRELAND

**Danfay Ltd.**  
61D, Sallynoggin Road, Dun Laoghaire, Co. Dublin  
Tel: 01-2859177

### GERMANY/SWITZERLAND

**Yamaha Europa GmbH.**  
Siemensstraße 22-34, 25462 Rellingen,  
F.R. of Germany  
Tel: 04101-3030

### AUSTRIA

**Yamaha Music Austria**  
Schleiergasse 20, A-1100 Wien Austria  
Tel: 01-60203900

### THE NETHERLANDS

**Yamaha Music Nederland**  
Kanaalweg 18G, 3526KL, Utrecht, The Netherlands  
Tel: 030-2828411

### BELGIUM

**Yamaha Music Belgium**  
Keiberg Imperiastraat 8, 1930 Zaventem, Belgium  
Tel: 02-7258220

### FRANCE

**Yamaha Musique France,**  
Division Claviers  
BP 70-77312 Marne-la-Vallée Cedex 2, France  
Tel: 01-64-61-4000

## ITALY

**Yamaha Musica Italia S.P.A.,**  
Home Keyboard Division  
Viale Italia 88, 20020 Lainate (Milano), Italy  
Tel: 02-935-771

## SPAIN

**Yamaha-Hazen Electronica Musical, S.A.**  
Jorge Juan 30, 28001, Madrid, Spain  
Tel: 91-577-7270

## PORTUGAL

**Valentim de Carvalho CI SA**  
Estrada de Porto Salvo, Paço de Arcos 2780 Oeiras,  
Portugal  
Tel: 01-443-3398/4030/1823

## GREECE

**Philippe Nakas S.A.**  
Navarinou Street 13, P.Code 10680, Athens, Greece  
Tel: 01-364-7111

## SWEDEN

**Yamaha Scandinavia AB**  
J. A. Wettergrens Gata 1  
Box 30053  
S-400 43 Göteborg, Sweden  
Tel: 031 89 34 00

## DENMARK

**YS Copenhagen Liaison Office**  
Generatorvej 8B  
DK-2730 Herlev, Denmark  
Tel: 44 92 49 00

## FINLAND

**Warner Music Finland OY/Fazer Music**  
Aleksanterinkatu 11, P.O. Box 260  
SF-00101 Helsinki, Finland  
Tel: 0435 011

## NORWAY

**Norsk filial av Yamaha Scandinavia AB**  
Grini Næringspark 1  
N-1345 Østerås, Norway  
Tel: 67 16 77 70

## ICELAND

**Skifan HF**  
Skeifan 17 P.O. Box 8120  
IS-128 Reykjavik, Iceland  
Tel: 525 5000

## OTHER EUROPEAN COUNTRIES

**Yamaha Europa GmbH.**  
Siemensstraße 22-34, 25462 Rellingen, F.R. of  
Germany  
Tel: 04101-3030

## AFRICA

**Yamaha Corporation,**  
International Marketing Division  
Nakazawa-cho 10-1, Hamamatsu, Japan 430  
Tel: 053-460-2312

## MIDDLE EAST

### TURKEY/CYPRUS

**Yamaha Europa GmbH.**  
Siemensstraße 22-34, 25462 Rellingen,  
F.R. of Germany  
Tel: 04101-3030

### OTHER COUNTRIES

**Yamaha Corporation,**  
International Marketing Division  
Nakazawa-cho 10-1, Hamamatsu, Japan 430  
Tel: 053-460-2312

## ASIA

### HONG KONG

**Tom Lee Music Co., Ltd.**  
11/F., Silvercord Tower 1, 30 Canton Road,  
Tsimshatsui, Kowloon, Hong Kong  
Tel: 730-1098

### INDONESIA

**PT. Yamaha Music Indonesia (Distributor)**  
**PT. Nusantik**  
Gedung Yamaha Music Center, Jalan Jend. Gatot  
Subroto Kav. 4, Jakarta 12930, Indonesia  
Tel: 21-520-2577

### KOREA

**Cosmos Corporation**  
#131-31, Neung-Dong, Sungdong-Ku, Seoul  
Korea  
Tel: 02-466-0021~5

### MALAYSIA

**Yamaha Music Malaysia, Sdn., Bhd.**  
16-28, Jalan SS 2/72, Petaling Jaya, Selangor,  
Malaysia  
Tel: 3-717-8977

### PHILIPPINES

**Yupangeo Music Corporation**  
339 Gil J. Puyat Avenue, P.O. Box 885 MCPO,  
Makati, Metro Manila, Philippines  
Tel: 819-7551

### SINGAPORE

**Yamaha Music Asia Pte., Ltd.**  
Blk 202 Hougang, Street 21 #02-01,  
Singapore 530202  
Tel: 382-1922

### TAIWAN

**Yamaha KHS Music Co., Ltd.**  
10F, 150, Tun-Hwa Northroad,  
Taipei, Taiwan, R.O.C.  
Tel: 02-717-3812

### THAILAND

**Siam Music Yamaha Co., Ltd.**  
121/60-61 RS Tower 17th Floor,  
Ratchadaphisek RD., Dindaeng,  
Bangkok 10320, Thailand  
Tel: 02-641-2951

### THE PEOPLE'S REPUBLIC OF CHINA AND OTHER ASIAN COUNTRIES

**Yamaha Corporation,**  
International Marketing Division  
Nakazawa-cho 10-1, Hamamatsu, Japan 430  
Tel: 053-460-2317

## OCEANIA

### AUSTRALIA

**Yamaha Music Australia Pty. Ltd.**  
17-33 Market Street, South Melbourne, Vic. 3205,  
Australia  
Tel: 3-699-2388

### NEW ZEALAND

**Music Houses of N.Z. Ltd.**  
146/148 Captain Springs Road, Te Papapa,  
Auckland, New Zealand  
Tel: 9-634-0099

### COUNTRIES AND TRUST TERRITORIES IN PACIFIC OCEAN

**Yamaha Corporation,**  
International Marketing Division  
Nakazawa-cho 10-1, Hamamatsu, Japan 430  
Tel: 053-460-2317

**HEAD OFFICE** Yamaha Corporation, Electronic Musical Instrument Division  
Nakazawa-cho 10-1, Hamamatsu, Japan 430  
Tel: 053-460-3273

