





DVD-S2300

DVD AUDIO/VIDEO SACD PLAYER
LECTEUR DE DVD AUDIO/VIDEO SACD

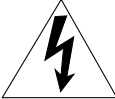

OWNER'S MANUAL
MODE D'EMPLOI

IMPORTANT SAFETY INSTRUCTIONS

	CAUTION RISK OF ELECTRIC SHOCK DO NOT OPEN	
CAUTION: TO REDUCE THE RISK OF ELECTRIC SHOCK, DO NOT REMOVE COVER (OR BACK). NO USER-SERVICEABLE PARTS INSIDE. REFER SERVICING TO QUALIFIED SERVICE PERSONNEL.		

• Explanation of Graphical Symbols

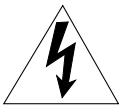

The lightning flash with arrowhead symbol, within an equilateral triangle, is intended to alert you to the presence of uninsulated "dangerous voltage" within the product's enclosure that may be of sufficient magnitude to constitute a risk of electric shock to persons.



The exclamation point within an equilateral triangle is intended to alert you to the presence of important operating and maintenance (servicing) instructions in the literature accompanying the appliance.

WARNING

TO REDUCE THE RISK OF FIRE OR ELECTRIC SHOCK, DO NOT EXPOSE THIS UNIT TO RAIN OR MOISTURE.

IMPORTANT

Please record the serial number of this unit in the space below.

MODEL:

Serial No.:

The serial number is located on the rear of the unit. Retain this Owner's Manual in a safe place for future reference.

WARNING

TO REDUCE THE RISK OF FIRE OR ELECTRIC SHOCK, DO NOT EXPOSE THIS UNIT TO RAIN OR MOISTURE.

- 1 Read these instructions.
- 2 Keep these instructions.
- 3 Heed all warnings.
- 4 Follow all instructions.
- 5 Do not use this apparatus near water.
- 6 Clean only with dry cloth.
- 7 Do not block any ventilation openings. Install in accordance with the manufacturer's instructions.
- 8 Do not install near any heat sources such as radiators, heat registers, stoves, or other apparatus (including amplifiers) that produce heat.
- 9 Do not defeat the safety purpose of the polarized or grounding-type plug. A polarized plug has two blades with one wider than the other. A grounding type plug has two blades and a third grounding prong. The wide blade or the third prong are provided for your safety. If the provided plug does not fit into your outlet, consult an electrician for replacement of the obsolete outlet.
- 10 Protect the power cord from being walked on or pinched particularly at plugs, convenience receptacles, and the point where they exit from the apparatus.
- 11 Only use attachments/accessories specified by the manufacturer.
- 12 Use only with the cart, stand, tripod, bracket, or table specified by the manufacturer, or sold with the apparatus. When a cart is used, use caution when moving the cart/apparatus combination to avoid injury from tip-over.
- 13 Unplug this apparatus during lightning storms or when unused for long periods of time.
- 14 Refer all servicing to qualified service personnel. Servicing is required when the apparatus has been damaged in any way, such as power-supply cord or plug is damaged, liquid has been spilled or objects have fallen into the apparatus, the apparatus has been exposed to rain or moisture, does not operate normally, or has been dropped.



CAUTION

FCC INFORMATION (for US customers)

1. IMPORTANT NOTICE : DO NOT MODIFY THIS UNIT!

This product, when installed as indicated in the instructions contained in this manual, meets FCC requirements. Modifications not expressly approved by Yamaha may void your authority, granted by the FCC, to use the product.

2. IMPORTANT : When connecting this product to accessories and/or another product use only high quality shielded cables. Cable/s supplied with this product MUST be used. Follow all installation instructions. Failure to follow instructions could void your FCC authorization to use this product in the USA.

3. NOTE : This product has been tested and found to comply with the requirements listed in FCC Regulations, Part 15 for Class "B" digital devices. Compliance with these requirements provides a reasonable level of assurance that your use of this product in a residential environment will not result in harmful interference with other electronic devices.

This equipment generates/uses radio frequencies and, if not installed and used according to the instructions found in the users manual, may cause interference harmful to the operation of other electronic devices.

Compliance with FCC regulations does not guarantee that interference will not occur in all installations. If this product is found to be the source of interference, which can be determined by turning the unit "OFF" and "ON", please try to eliminate the problem by using one of the following measures:

Relocate either this product or the device that is being affected by the interference.

Utilize power outlets that are on different branch (circuit breaker or fuse) circuits or install AC line filter/s.

In the case of radio or TV interference, relocate/reorient the antenna. If the antenna lead-in is 300 ohm ribbon lead, change the lead-in to coaxial type cable.

If these corrective measures do not produce satisfactory results, please contact the local retailer authorized to distribute this type of product. If you can not locate the appropriate retailer, please contact Yamaha Electronics Corp., U.S.A. 6660 Orangethorpe Ave, Buena Park, CA 90620.

The above statements apply ONLY to those products distributed by Yamaha Corporation of America or its subsidiaries.

DANGER	- VISIBLE AND INVISIBLE LASER RADIATION WHEN OPEN. AVOID DIRECT EXPOSURE TO BEAM. (FDA 21 CFR)
CAUTION	- VISIBLE AND INVISIBLE LASER RADIATION WHEN OPEN. AVOID EXPOSURE TO BEAM. (IEC 60825-1)
ATTENTION	- RAYONNEMENT LASER VISIBLE ET INVISIBLE EN CAS D'OUVERTURE. EXPOSITION DANGEREUSE AU FAISCEAU.
ADVARSEL	- SYNLIG OG USYNLIG LASERSTRÅLING VED ÅBNING. UNDGÅ UDSÆTTELSE FOR STRÅLING.
VARO!	- AVATTAESSA OLET ALTIIKINA NÄKYVÄÄ JA NÄKYMÄTÖN LASERSÄTEILYLLE, ÄLÄ KATSO SÄTEESEEN.
WARNING	- SYNLIG OCH OSYNLIG LASERSTRÅLING NÄR DENNA DEL ÄR ÖPPNAD. BETRakta EJ STRÅLEN.
ADVARSEL	- SYNLIG OG USYNLIG LASERSTRÅLING NÄR DEKSEL ÅPNES. UNNGÅ EKSPONERING FOR STRÅLEN.
VORSICHT	- SICHTBARE UND UNSICHTBARE LASERSTRAHLUNG, WENN ABDECKUNG GEOFFNET. NICHT DEM STRAHL AUSSETZEN.
注意	- 打开时有可见及不可见激光辐射。避免激光束照射。
注意	- ここを開くと可視及び不可視のレーザー光が出ます。 ビームを直接見たり、触れたりしないでください。 RQLS0233

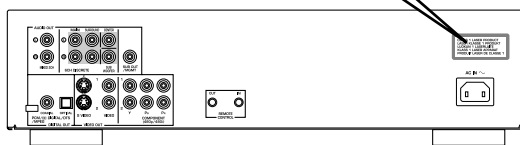
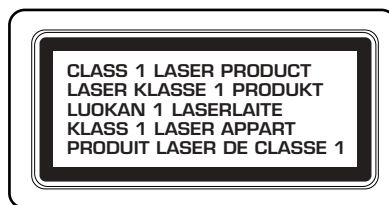
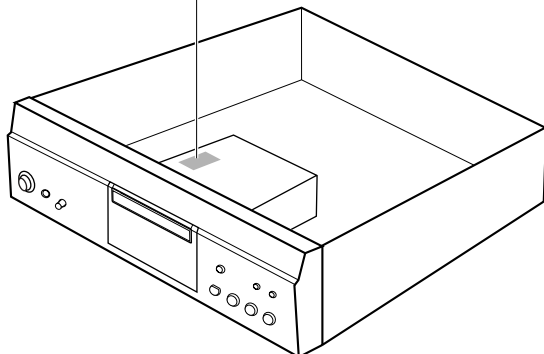

CAUTION

CAUTION: READ THIS BEFORE OPERATING YOUR UNIT.

- 1 To assure the finest performance, please read this manual carefully. Keep it in a safe place for future reference.
- 2 Install this sound system in a well ventilated, cool, dry, clean place — away from direct sunlight, heat sources, vibration, dust, moisture, or cold. In a cabinet, allow about 2.5cm (1 inch) of free space all around this unit for adequate ventilation.
- 3 Locate this unit away from other electrical appliances, motors, or transformers to avoid humming sounds.
- 4 Do not expose this unit to sudden temperature changes from cold to hot, nor locate this unit in an environment with high humidity (i.e., a room with a humidifier) to prevent condensation inside this unit, which may cause an electrical shock, fire, damage to this unit, and/or personal injury.
- 5 Avoid installing this unit in a location where foreign objects may fall onto this unit or where this unit may be exposed to liquid dripping or splashing. On the top of this unit, do not place:
 - Other components, as they may cause damage and/or discoloration on the surface of this unit.
 - Burning objects (i.e., candles), as they may cause fire, damage to this unit, and/or personal injury.
 - Containers with liquid in them, as they may fall, spilling the liquid and causing an electrical shock to the user and/or damage to this unit.
- 6 Do not cover this unit with a newspaper, tablecloth, curtain, etc. in order not to obstruct heat radiation. If the temperature inside this unit rises, it may cause fire, damage to this unit, and/or personal injury.
- 7 Do not plug in this unit to a wall outlet until all connections are complete.
- 8 Do not operate this unit upside-down. It may overheat, possibly causing damage.
- 9 Do not use excessive force on switches, knobs and/or cords.
- 10 When disconnecting the power cord from the wall outlet, grasp the plug; do not pull the cord.
- 11 Do not clean this unit with chemical solvents; this might damage the finish. Use a clean, dry cloth.
- 12 Use only the voltage specified on this unit. Using this unit with a higher voltage than specified is dangerous and may cause fire, damage to this unit, and/or personal injury. YAMAHA will not be held responsible for any damage resulting from use of this unit with a voltage other than as specified.
- 13 To prevent damage by lightning, disconnect the power cord from the wall outlet during an electrical storm.
- 14 Do not attempt to modify or fix this unit. Contact qualified YAMAHA service personnel when any service is needed. The cabinet should never be opened for any reason.
- 15 When not planning to use this unit for long periods of time (i.e., vacation), disconnect the AC power plug from the wall outlet.
- 16 Be sure to read the “TROUBLESHOOTING” section on common operating errors before concluding that this unit is faulty.
- 17 Before moving this unit, press STANBY/ON to set the unit in standby mode, then disconnect the AC power plug from the wall outlet.

FOR CANADIAN CUSTOMERS

To prevent electric shock, match wide blade of plug to wide slot and fully insert.
This Class B digital apparatus complies with Canadian ICES-003.

DANGER

This unit emits visible laser radiation when open. Avoid direct eye exposure to beam.
When this unit is plugged into a wall outlet, do not place your eyes close to the opening of the disc tray and other openings to look inside.

The laser component in this product is capable of emitting radiation exceeding the limit for Class 1.

We Want You Listening For A Lifetime

YAMAHA and the Electronic Industries Association's Consumer Electronics Group want you to get the most out of your equipment by playing it at a safe level, one that lets the sound come through loud and clear without annoying, blaring or distorting – and, most importantly, without damaging your sensitive hearing.

Since hearing damage from loud sounds is often undetectable until it is too late, YAMAHA and the Electronic Industries Association's Consumer Electronics Group recommend that you avoid prolonged exposure to excessive volume levels.



CAUTION

CONTENTS

INTRODUCTION

FEATURES	2
Playable disc formats.....	2
CHECKING THE ACCESSORIES	3
INSTALLING BATTERIES IN THE REMOTE CONTROL	3
CONTROLS AND FUNCTIONS	4
Front panel / Remote control.....	4
Front panel display	6

PREPARATION

CONNECTIONS.....	7
Types of connectors	7
Video connections.....	8
Audio connections	9
Remote control in/out jack	9

PLAYING A DISC

PLAYING A DISC	10
Before starting playback	10
Basic operation	10
Super Audio CDs	12
MP3 playback	12
MISCELLANEOUS FUNCTIONS.....	13
Using disc menus.....	13
Enhancing video quality - Progressive output (U.S.A. model only) ...	13
DVD-Audio features	14
Switching audio tracks, subtitles and angles	15
Program play	16
Random play	17
All group play	17
Bookmarks	18
Repeat play	18
Repeat A-B	19
ON-SCREEN MENU (DVD MODE ONLY).....	20
Operating the menu bar	20
Disc Info bar	21
Player Info bar	22
Shuttle bar.....	23

■ About this manual

- Illustrations in this manual are based on the U.S.A. model unless otherwise indicated.
- Paragraphs marked with an ✨ indicator are tips on operating the unit.
- The user can perform certain operations using either the remote control or the buttons on the main unit. This manual frequently explains how to execute such operations only on the remote control.
- This manual is printed prior to production. Design and specifications of the unit are subject to change for reasons that include improved function and operation.
- Illustrations in this manual may differ slightly from the product or from illustrations used in the packaging.
- The names of package content items used in this manual may differ slightly from names that appear on the product or elsewhere in the packaging.

DETAILED SETTINGS

CHANGING THE DVD MODE SETTINGS.....	24
Using the Setup menu.....	24
Settings Summary.....	25
Ratings	28
PCM down conversion	28
Speaker settings	29
CHANGING THE SACD MODE SETTINGS.....	31
Speaker settings	31
Adjusting the brightness of the display	32
Changing the time indicator	32

APPENDIX

TROUBLESHOOTING	33
GLOSSARY.....	35
NOTES ON HANDLING DISCS	36
SPECIFICATIONS.....	37

FEATURES

- ◆ Built-in high-performance video D/A converter
- ◆ Output connectors support numerous audio and home theater component combinations.

Video out:

Component output jacks (two channels)
(U.S.A. and Australian models)

S Video jacks (two channels)

RGB SCART jacks (U.K. and European models)

Video (Composite) connector (two channels)

Audio out:

Digital: Coaxial jack (one channel)
Optical jack (one channel)

Analog: (L/R) jacks
6ch discrete jacks
SUB OUT/BASS MGMT (management) jack to boost the low range

- ◆ High-end D/A converter for SACD on all eight channels
- ◆ D/A converter support for 192kHz 24-bit DVD-Audio/Video discs
- ◆ Optimal picture and sound quality, courtesy of independent circuits for SACD and DVD, and individual tuning
- ◆ Dolby Digital and DTS decoders
- ◆ DCDi Progressive output (U.S.A. model)
- ◆ MP3 multi-session support



Manufactured under license from Dolby Laboratories. "Dolby" and the double-D symbol are trademarks of Dolby Laboratories.



"DTS" and "DTS Digital Surround" are registered trademarks of Digital Theater Systems, Inc.



"DCDi" is a trademark of Faroudja, a division of Genesis Microchip, Inc.

This product incorporates copyright protection technology that is protected by method claims of certain U.S. patents and other intellectual property rights owned by Macrovision Corporation and other rights owners. Use of this copyright protection technology must be authorized by Macrovision Corporation, and is intended for home and other limited viewing uses only unless otherwise authorized by Macrovision Corporation. Reverse engineering or disassembly is prohibited.

Playable disc formats

This unit can play the disc types associated with the logos shown below. (Do not attempt to load any other type of disc into the unit, or the unit may be damaged.)

- DVD mode
- SACD mode



This manual refers to disc types using the following indicators:

DVD-Video	DVD-Audio	Video CD	Audio CD
DVD-V	DVD-A	VCD	CD

Super Audio CD
SACD

Notes

- The unit does not support playback of the following discs: Photo CD, CD-ROM, DVD-ROM, DVD-RAM, SVCD, CDV
- Some discs may fail to play due to recording conditions or disc characteristics. (If you record discs on a recorder for playback on this unit, use discs from reliable manufacturers.)
- DVD-RW discs will play only if they are recorded in video format.
- CD-R/RW, DVD-R/RW, and DVD+R discs will play only if they are finalized.
- Do not use non-standard shaped discs (heart-shaped, etc.).
- Some DVD and VCD features described in this manual may vary in function due to differences in software design from various manufacturers. Check the instructions for each disc.
- This unit cannot play PAL video discs. (U.S.A. model)

Region management information

The unit is designed to support the Region Management System. Check the regional code number on the disc package. If the number does not match the unit's region number (see table below, or see back of unit), the unit may be unable to play the disc.

Model	Region number of this unit	Discs can be played
U.S.A. and Canadian models	1	1, ALL or a mark that includes the region number 1.
U.K. and European models	2	2, ALL or a mark that includes the region number 2.
Australian model	4	4, ALL or a mark that includes the region number 4.

CHECKING THE ACCESSORIES

Check your package to make sure it contains the following items:

Remote control

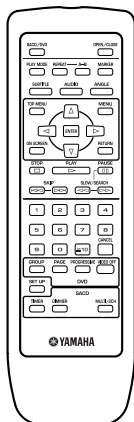

Batteries (x2) (AA, R6, UM-3)

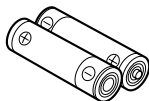

Audio/Video cable

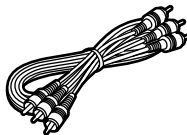

Power cable

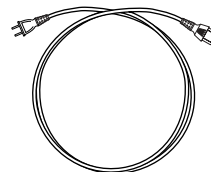

INSTALLING BATTERIES IN THE REMOTE CONTROL

Insert the batteries in the correct direction by aligning the + and - marks on the batteries with the polarity markings (+ and -) inside the battery compartment.

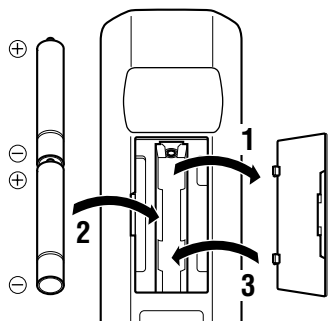

1 Slide off the battery compartment cover.

2 Insert two batteries (AA, R06, UM-3 type) oriented properly (+ and -).

3 Slide the cover back into place.

Replace worn batteries

Worn batteries limit the operating range of the remote control. Replace both batteries at the same time.

Note

- Replace both batteries if you notice a decrease in the operating range of the remote control.
- Do not use old batteries with new ones.
- Do not use different types of batteries (such as alkaline and manganese) together. Read the battery packaging carefully. Different types of batteries may be the same shape or color.

- If the batteries leak, dispose of them immediately. Avoid touching the leaked material or letting it come into contact with clothing, etc. Clean the battery compartment thoroughly before installing new batteries.

Using the remote control

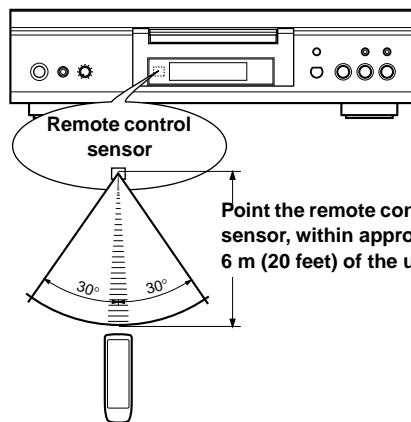

Point the remote control at the sensor, within approximately 6 m (20 feet) of the unit.

Handling the remote control

- Do not spill water or other liquids on the remote control.
- Do not drop the remote control.
- Do not leave or store the remote control in the following types of conditions:
 - high humidity or temperature, such as near a heater, stove or bath;
 - dusty places; or
 - places subject to extremely low temperatures.

CONTROLS AND FUNCTIONS

Front panel / Remote control

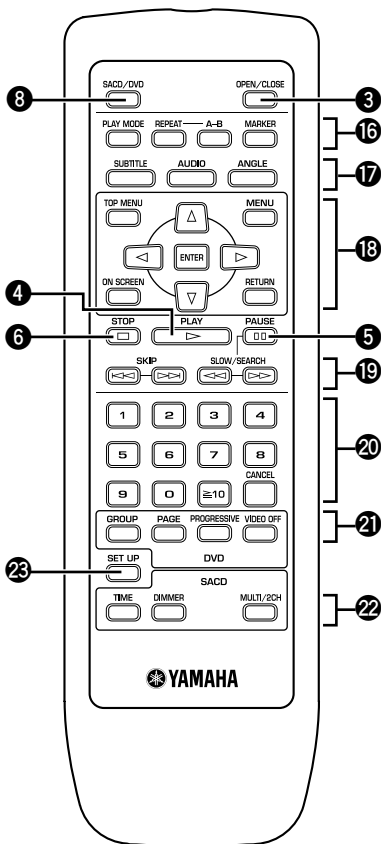
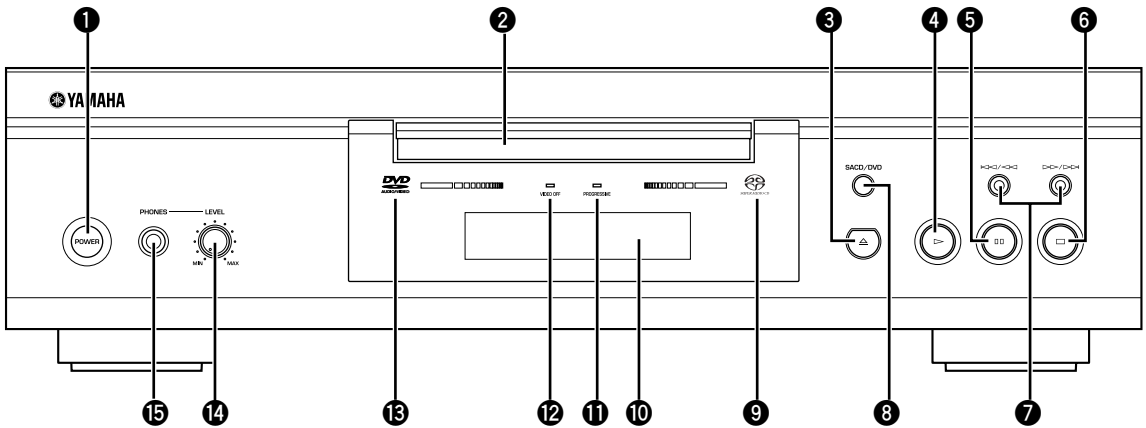

- 1 POWER**
Turns the power to the unit on and off.
- 2 Disc tray**
Load a disc in this tray.
- 3 \triangle (Front panel), OPEN/CLOSE (Remote control)**
Press to open or close the disc tray.
- 4 \triangleright**
Press to start playback.
- 5 \parallel**
Press to pause.
- 6 \square**
Press to stop playback.
- 7 $\lll / \lll, \ggg / \ggg$**
Press to access the next or previous track or chapter. Press and hold down to fast forward or fast reverse.
- 8 SCD/DVD**
Press to switch between DVD mode and SACD mode.
- 9 SCD mode indicator**
Lights up in SACD mode.
- 10 Front panel display**
Shows information about the operational status or default settings of the unit.
- 11 PROGRESSIVE indicator (U.S.A. model only)**
Lights up during progressive output.
- 12 VIDEO OFF indicator**
Lights up when the VIDEO OFF function is working.
- 13 DVD mode indicator**
Lights up in DVD mode.
- 14 PHONES LEVEL control**
Adjusts the headphone level.
- 15 PHONES**
Connect headphones here.

- 16 From left:**
PLAY MODE
 Press to switch between random play, program play, and normal playback.
REPEAT
 Press to repeat playback.
A-B
 Press to repeat a section specified by two points.
MARKER
 Press to mark and store location points for future reference.
- 17 From left:**
SUBTITLE
 Press to select a subtitle language.
AUDIO
 Press to select a DVD-Audio language.
ANGLE
 Press to change the camera angle on discs recorded with multiple camera angles.
- 18 From top left:**
TOP MENU
 Press to display the top-level disc menu screen.
MENU
 Press to display a menu screen.
Δ, ∇, ◀, ▶/ENTER
 Press to select and execute a menu item.
ON SCREEN
 Press to turn the on-screen icons on or off on the video monitor.
RETURN
 Press to display the previous screen when navigating the menus.
- 19 From left:**
◀◀ ▶▶ (skip)
 Press repeatedly to locate the top of the previous or subsequent tracks.
◀◀ ▶▶ (slow/search)
 Press to fast reverse or fast forward.
- 20 Numeric buttons**
 Press to enter numbers.
CANCEL
 Press to cancel a mode or setting.
- 21 From left:**
GROUP
 Press to select a DVD-Audio group.
PAGE
 Press to select a DVD-Audio still picture.
PROGRESSIVE button (U.S.A. model only)
 Press to toggle between progressive video output and interlaced video output in DVD mode.
VIDEO OFF
 Press to switch video output on and off during DVD-Audio playback.
- 22 From left:**
TIME
 Press to select the time display in SACD mode.
DIMMER
 Press to adjust the brightness of the front panel display in SACD mode.
MULTI/2CH
 Press to toggle between stereo playback and multi-channel playback in SACD mode during playback of a super-audio CD that contains both stereo (two channels) and multi-audio channel data.
- 23 SETUP**
 Press to display the setup menu screen.

Front panel display

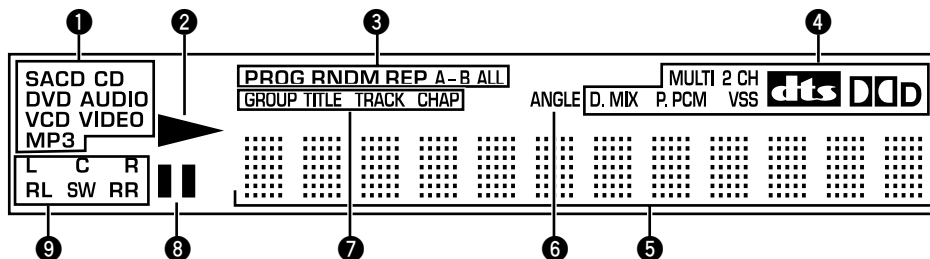

1 Disc type indicators

The indicator for the type of disc currently being played lights up.

- SACD:** Super audio CD
CD: Audio CD
DVD AUDIO: DVD-Audio
DVD VIDEO: DVD-Video
VCD: Video CD
MP3: MP3-format CD-R or CD-RW

2 Playback indicator

Lights up during playback. Blinks while the resume function is operating (see “Resume function” on page 10).

3 Play mode indicators

The indicator for the current playback mode lights up.

- PROG:** Program play
RNDM: Random play
REP: Repeat play
REP A-B: Repeat A-B
REP ALL: Repeat All

4 Audio format indicators

The indicator for the disc audio format lights up. If multiple audio formats are recorded on a disc, the indicator for the format selected by the disc menu or unit operation lights up.



DDD (Dolby Digital)

PCM (Linear PCM)

P.PCM (Packed PCM)

MULTI (Multi-channel)

2 CH (2-channel)

D.MIX (Down Mix):

This indicator lights up during playback of a DVD-Audio track that has multiple audio channel signals (that can be mixed down to two channels).

VSS:

Lights up in virtual surround mode.

5 Multi-information display

Displays various information, including the disc title, chapter number, track number, elapsed playing time, etc.

6 ANGLE indicator

Lights up during playback of those scenes for which the DVD features multiple camera angles.

7 Multi-information display mode indicators

- GROUP:** The display indicates a group number.
TITLE: The display indicates a title number.
TRACK: The display indicates a track number.
CHAP: The display indicates a chapter number.

8 Pause indicator

Lights up when the picture freezes or disc playback pauses.

9 Speaker channel indicators

The indicators for the current audio channel light up.
L: left main; **C:** center; **R:** right main; **RL:** left rear;
SW: subwoofer; **RR:** right rear

CONNECTIONS

Before you make connections, unplug the power cable for the unit and all other components. Do not plug in the power cables until all connections are complete.

Types of connectors

Connect these audio output jacks to the audio input of an AV amplifier.

Connect these video output jacks to the video input of an AV amplifier or the input of a video monitor.

TO AC OUTLET

After all connections are complete, plug the included power cable into an AC outlet.

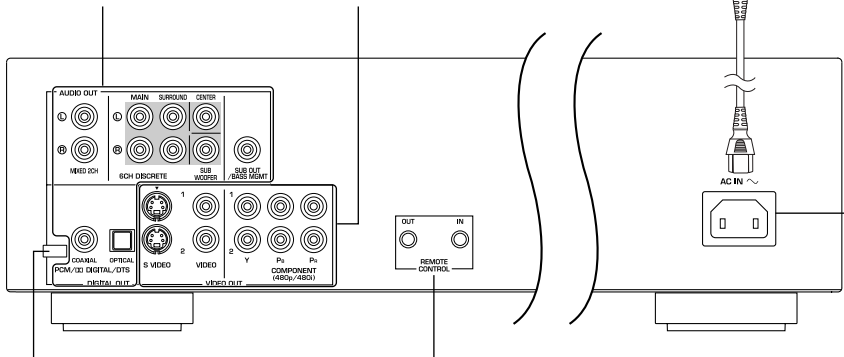

This jack is reserved for factory use. Do not connect any equipment to this jack.

Remote control in/out jacks

Use the following commercially-available cables to make connections:

Audio cables

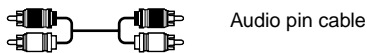

Audio pin cable



Coaxial cable



Optical cable

Video cables



Video pin cable



S Video cable

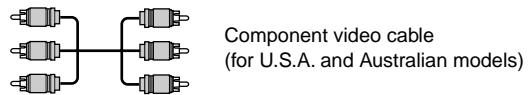

Component video cable
(for U.S.A. and Australian models)

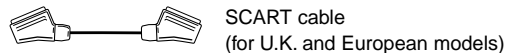

SCART cable
(for U.K. and European models)

A/V cable

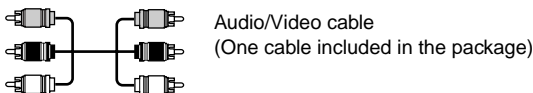

Audio/Video cable
(One cable included in the package)

Video connections

You can connect the unit's video output to a video monitor, or the video input on an AV amplifier (which in turn is connected to a video monitor). Connecting to an AV amplifier enables you to control audio and video using the AV amplifier. You can set up the AV amplifier using this unit's OSD (on-screen display).

This unit features several types of video output jacks. Determine the one compatible with the inputs on your video monitor. Use the appropriate cable to connect the unit to an AV amplifier, and the AV amplifier to the monitor.

1 S VIDEO outputs (1, 2)

The S VIDEO jacks output discrete C and Y signals to reproduce higher-quality images than normal composite video. Connect one end of an S Video cable (not included) to either S VIDEO jack. Connect the other end to an S Video input on an AV amplifier or video monitor.

2 VIDEO outputs (1, 2)

The VIDEO jacks output normal composite video signals. Use the yellow plugs on an audio/video cable to connect either VIDEO jack to a video input on an AV amplifier or video monitor.

The same signal is output from VIDEO 1 and VIDEO 2, enabling connection to two devices (e.g., a monitor and an AV amplifier) simultaneously.

3 COMPONENT outputs

(U.S.A. and Australian models only)

These jacks output three discrete CCY signals ("component video") to reproduce a higher-quality image than S Video.

(U.S.A. model only)

This unit features a DCDi circuit (with the latest contour correction technology) and progressive output, which produces very smooth and natural high-quality pictures even on a big screen. Use a component video cable (not included) to connect the COMPONENT output jacks to the component video input connectors on an AV amplifier or video monitor.

4 AV connector

(U.K. and Europe models only)

If your monitor has only one jack for video input, you can use the SCART output jack on this unit to connect the unit directly to the monitor. This connection provides the best picture quality.

Note

- Do not connect this unit to a video monitor through a video cassette recorder. If you do so, the picture may not play back properly due to the copyright protection technology incorporated in this unit.

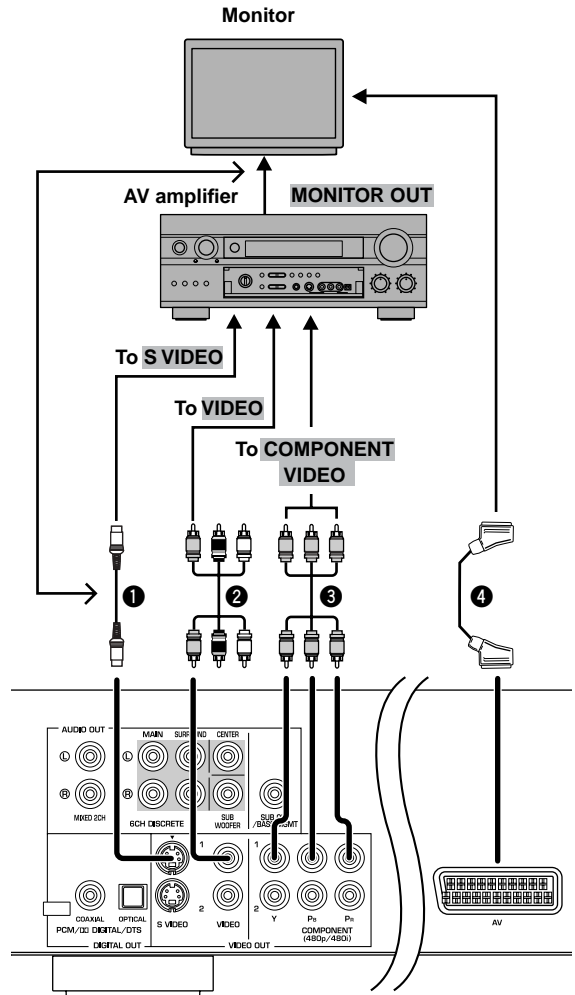

Audio connections

Select connectors that are compatible with your amplifier and appropriate for your requirements.

1 DIGITAL OUT jacks

Using AV amplifier's 6.1 channel decoding (DVD-Video) and surround effects:

- Connect the OPTICAL jack to the amplifier's optical digital input using fiber optic cable (not included)
- or-
- Connect the COAXIAL jack to the amplifier's coaxial digital input using coaxial digital cable (not included).

Note

- No audio signal is output from DIGITAL OUT during SACD playback. Use connection 2 or 3 below.

2 MIXED 2CH jacks

Use the included audio/video pin cable to connect these jacks to analog stereo input jacks on the amplifier. Connect the white plug to the L jack. Connect the red plug to the R jack. (The yellow plug is used for the video signal.)

3 6CH DISCRETE jacks

Playing SACD or DVD multi-channel audio:

Use an audio pin cable (not included) to connect these jacks to the corresponding channel inputs (such as MAIN L/R, CENTER) on the amplifier (often labelled "6CH INPUT").

Connect the SUBWOOFER jack to the subwoofer input on the amplifier. This jack outputs a more natural, high-fidelity low range relative to the SUB OUT/BASS MGMT jack explained below. However, during playback of a two-channel (stereo) source, the subwoofer does not output any sound due to lack of LFE (low-frequency effects assigned to a subwoofer).

★ SUB OUT/BASS MGMT jack

SUB OUT/BASS MGMT aggregates and outputs the low ranges of all channels. An alternative to 6CH DISCRETE SUBWOOFER output, this jack outputs a powerful and supple sound even when the main speaker is small (with a woofer diameter of 16cm or less).

Use an audio pin cable (not included) to connect the SUB OUT/BASS MGMT jack to the subwoofer input on the amplifier.

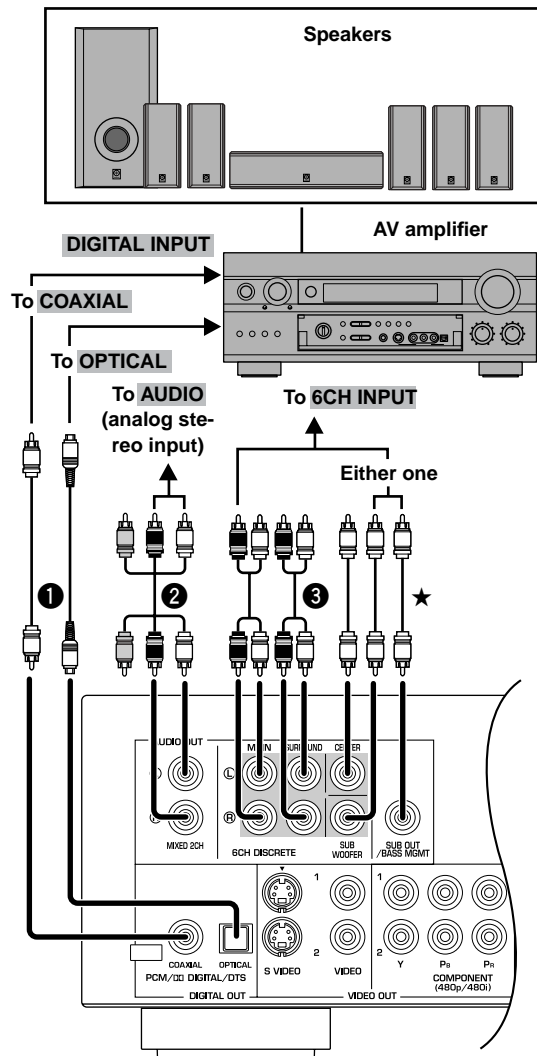

Remote control in/out jack

These jacks are used in custom installations to transmit remote control signals via cable.

- Connect REMOTE CONTROL IN to an output on your remote control system.
- Connect REMOTE CONTROL OUT to a remote control input on another component to enable system control.

PLAYING A DISC

Before starting playback

Before playing a disc, you must connect the unit's audio and video output jacks to an AV amplifier or other system component (refer to pages 8 and 9).

Note

- If you digitally connect the unit to an amplifier that does not feature a DTS decoder, set DTS DIGITAL SURROUND to PCM (factory default) in the Setup/Audio menu. Otherwise, unprocessed digital signal noise will be output that may damage your hearing or speakers.

Basic operation

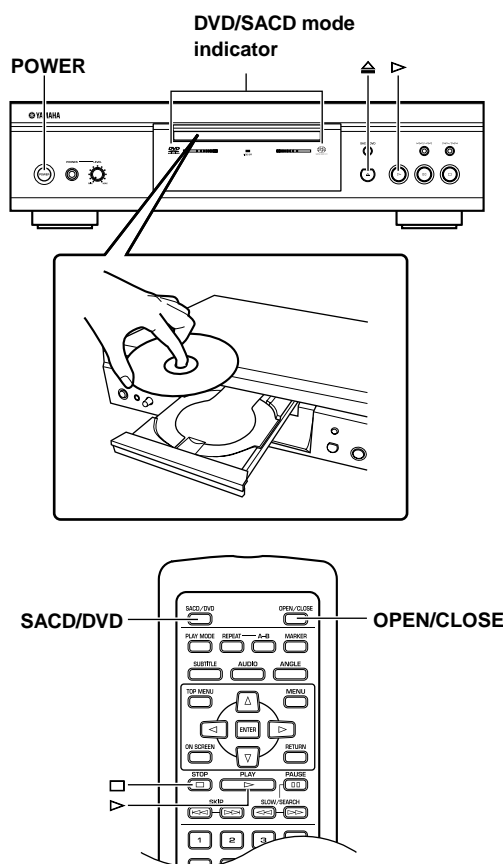

- 1** Press POWER to turn on the power.
- 2** Press OPEN/CLOSE to open the disc tray.
- 3** Load a disc into the disc tray.

- 4** If necessary, press SACD/DVD to change the mode.

For more information, refer to “Switching disc play mode” on page 10 (below).

- 5** Press \blacktriangleright .

The disc tray closes and playback starts.



- If one of the following indicators is displayed **DVD-A** **DVD-V** **VCD** refer to “Using disc menus” on page 13.
- When the unit finishes playing a DVD, it stops playback or displays a menu screen.

Note

- The unit cannot play CD-R or CD-RW discs that have not been finalized. Be sure to finalize discs on a CD recorder before playing them in this unit. (The term “finalize” refers to an audio process for CD-Rs or CD-RWs that prepares them for play on supporting players.)

Switching disc play mode

While the unit is stopped or the disc tray is open, press SACD/DVD.

The unit includes independent playback circuits for SACDs and DVDs to optimize use of each disc type.

- To play an SACD, switch to SACD mode.
- To play other types of discs, switch to DVD mode.

Use SACD mode to play **SACD.**

The SACD mode indicator lights up.

Use DVD mode to play **DVD-A, **DVD-V**, **VCD**, and**

CD

The DVD mode indicator lights up.



- If you are playing a hybrid disc that contains both SACD format data and conventional CD format data, select SACD mode to play the SACD format data, or DVD mode to play the CD format data.

To stop playback

Press \square .

Resume function

The unit retains memory of the point at which you pressed the \square button as long as the power to the unit is turned on. During this time, the \blacktriangleright indicator will flash on the display. Press \blacktriangleright to resume playback from the stop point.

To clear the memory, press \square again. The \blacktriangleright indicator disappears. (When a DVD-Video disc is played, a chapter review screen will appear.)

Note

- Opening the disc tray cancels the resume function.

■ Chapter review function DVD-V

This function plays the first few seconds of each chapter (from the beginning of the title up to the memorized point) so you can review previous chapters.

Press \triangleright while the chapter review message is displayed on screen. (If you do not press \triangleright , after a while the message disappears and playback resumes.)

Notes

- This function may not work on some DVDs.
- Canceling the resume function also clears the chapter review function.

■ After operating the unit

Press \triangle to open the disc tray. Remove the disc, then press POWER to turn off the unit.

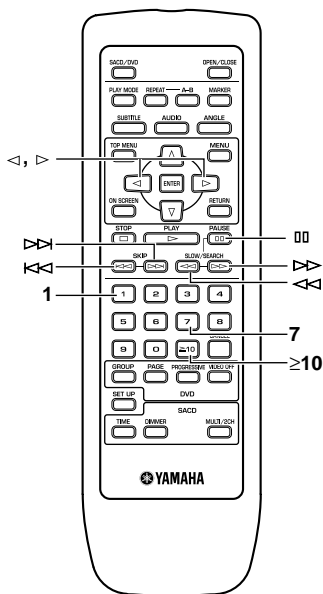

■ Skip

On the remote control, press $\triangleright\triangleright$ (or $\triangleleft\triangleleft$) to skip forward (or backward).

On the front panel, press $\triangleright\triangleright/\triangleright\triangleright$ (or $\triangleleft\triangleleft/\triangleleft\triangleleft$) to skip forward (or backward).

Press $\triangleleft\triangleleft$ on the remote control or $\triangleleft\triangleleft/\triangleleft\triangleleft$ on the front panel to locate the top of the current chapter or track.

Note

- VCDs that use playback control (page 13) may not allow the skip operation to function as described above.

■ Selecting a track

SACD VCD CD

Key in the desired track number using the numeric buttons.

Example (to select track 27):

VCD CD

1 Press ≥ 10 .

2 Press 2.

3 Press 7.

SACD

1 Press ≥ 10 twice.

2 Press 7.

■ Search

On the remote control, press $\triangleright\triangleright$ (or $\triangleleft\triangleleft$) to search forward (or backward).

-or-

On the front panel, press and hold $\triangleright\triangleright/\triangleright\triangleright$ (or $\triangleleft\triangleleft/\triangleleft\triangleleft$) to search forward (or backward).



- To increase search speed, repeatedly press (or press and hold) $\triangleright\triangleright$ or $\triangleleft\triangleleft$ on the remote control, or press and hold $\triangleright\triangleright/\triangleright\triangleright$ or $\triangleleft\triangleleft/\triangleleft\triangleleft$ on the front panel.

■ Pause

Press \square during playback.

To resume playback, press \triangleright .

■ Frame advance/reverse

DVD-A DVD-V VCD

To advance or reverse frames: While the picture is still or in pause mode, press the cursor buttons (\triangleleft , \triangleright).

- To return to normal playback, press \triangleright .
- Press the cursor buttons (\triangleleft , \triangleright) repeatedly, or press and hold them, to advance or reverse frames at increasing rates of speed.
- Pressing \square also advances a few frames.
- On certain DVD-Audio discs, frames may advance or reverse only during the video portions of the disc.

Note

- The Video CD format does not permit reverse navigation.

■ Slow DVD-A DVD-V VCD

To play a disc slowly, while the picture is still or paused:

Press ◀◀ or ▶▶ on the remote control.

-or-

Press and hold ▶▶/▶▶ (or ◀◀/◀◀) on the front panel.

- To return to normal playback, press ▷.
- To increase the speed, repeatedly press (or press and hold) ▶▶, ◀◀ on the remote control; or press and hold ▶▶/▶▶, ◀◀/◀◀ on the front panel.

Note

- The Video CD format does not permit reverse navigation.

Super Audio CDs

There are three types of Super Audio CDs:

- a *2-channel disc* that contains stereo audio
- a *multi-channel disc* that includes up to six (6) channels of data
- a *combination disc* that includes a 2-channel data area and a multi-channel data area.



■ Switching between different channel areas

Select your desired area for playback on a combination disc.

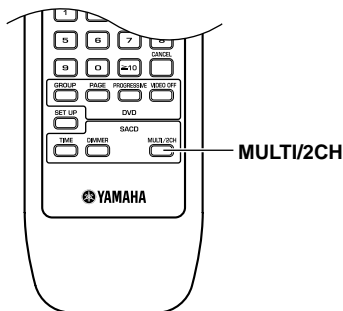

While the unit is stopped, press MULTI/2CH.

When the multi-channel area is selected, the MULTI indicator lights up on the display. When the 2-channel area is selected, the 2CH indicator lights up on the display.

MP3 playback

The unit can play MP3 format audio that was recorded by a computer onto CD-R or CD-RW.

- If an MP3 file is of poor quality, playback may not be possible.

Disc Structure Example

MP3 discs are different than standard audio CDs.

The MP3 format is so compact and efficient that the equivalent of several albums or standard audio CDs may be stored on a single MP3 disc.

The unit creates a folder for the “Title” and a file for each “Chapter.”

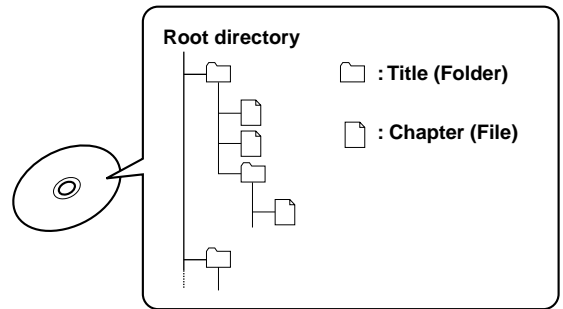

Starting playback from a selected chapter

Select a chapter using the numeric buttons (see “Selecting a track” on page 11), then press ENTER to play the chapter.

Repeat play

To repeat playback, use chapter repeat or title repeat (see page 18 for details).

Notes

- This unit can play MP3 discs recorded at bit rates of 32kbps to 320kbps and sampling frequencies of 44.1kHz and 48kHz. (A sampling frequency of 32kHz is not supported.)
- Program play and random play are unavailable on MP3 discs.
- Chapters may not play in the order selected at the time of recording.

Disc info icons (on-screen) during playback

Total chapter number



Current chapter

Elapsed play time (for display only)

MISCELLANEOUS FUNCTIONS

Using disc menus

Many discs include menu screens that enable you to control special features, such as skipping to a favorite title or chapter, or selecting an audio language or subtitle language for a movie. This section provides general instructions on operating these screens.

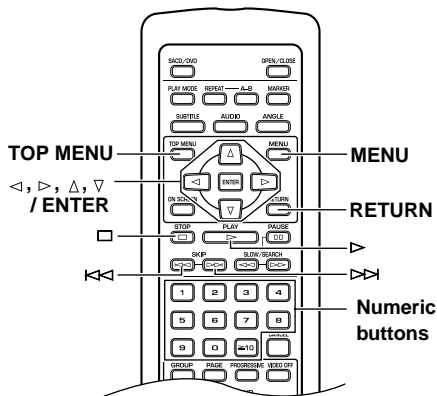

DVD-A DVD-V

1 Press TOP MENU or MENU during playback.

The video monitor displays a menu.

- On certain discs, the menu appears automatically when you start playback.

2 Press the cursor buttons (▲, ▼, ◀, ▶) to select the desired item, then press ENTER. (If another menu screen appears, repeat this step.)

Video CD playback control (PBC menu play) VCD

Video CDs that feature “playback control” allow you to navigate certain scenes or information by menu. This manual refers to the use of menus to control Video CD playback as “menu play.”

- Numeric buttons:** Press to select the desired item.
- RETURN:** Press to display the initial menu screen.
- ▶ (PLAY):** Press to play the selected item.
- ▶▶:** Press to display the next screen.
- ◀◀:** Press to display the previous screen.
- (STOP):** Press while a menu is displayed to cancel playback control.

Notes

- Playback control is automatically canceled during program play or random play.
- Certain discs may not respond as described above.

Enhancing video quality - Progressive output (U.S.A. model only)

The unit’s COMPONENT video jack can output progressive signals to a progressive signal compatible monitor for an extra high-quality picture.

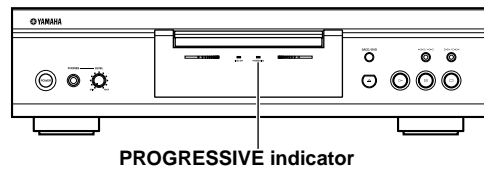
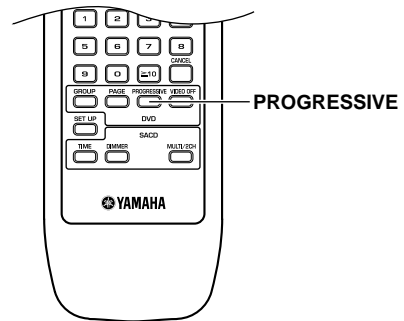

Press PROGRESSIVE.

The PROGRESSIVE indicator lights up.

To cancel this feature, press PROGRESSIVE again.

Notes

- If the screen shifts off center during progressive output, refer to “Adjusting the screen position,” described below.
- When playing 4:3 aspect video on a 16:9 aspect wide-screen monitor using progressive output, the picture may stretch horizontally to fill the screen. In this case, change the aspect ratio to suit the monitor. If this is not possible, turn the progressive feature off. (The progressive output will switch to interlace output.)
- When the progressive function is working, video signals are output from only the COMPONENT output jacks.

■ Adjusting the screen position (when using progressive output)

Progressive signals output from the unit may shift off center on certain monitors. To adjust the screen position, use the remote control as follows:

- 1** Press **PAUSE** to pause playback.
- 2** Follow step 1 under “Operating the menu bar” on page 20 to display the Picture setting.
- 3** Press the cursor buttons (**LEFT**, **RIGHT**) to select the right-most icon (**RIGHT**).
- 4** Adjust the screen position.
To move the image to the left, press numeric button 1. To move the image to the right, press numeric button 3.

Example:



Press 3 to move to the right.

- Pressing numeric button 2 after pressing 1 or 3 sets the screen back to the original position.
- To check whether the picture is centered, switch to normal output (press **PROGRESSIVE** to turn the indicator off).

- 5** Save the adjusted position.
First press **EXIT**, then press **SETUP** to display the setup menu. Press **SETUP** again (or **RETURN**) to save the position. (Even if you skip this step, the position will be saved until you turn the power off.)

CONSUMERS SHOULD NOTE THAT NOT ALL HIGH DEFINITION TELEVISION SETS ARE FULLY COMPATIBLE WITH THIS PRODUCT AND MAY CAUSE ARTIFACTS TO BE DISPLAYED IN THE PICTURE. IN CASE OF 525 PROGRESSIVE SCAN PICTURE PROBLEMS, IT IS RECOMMENDED THAT YOU SWITCH THE CONNECTION TO THE “STANDARD DEFINITION” OUTPUT. IF THERE ARE QUESTIONS REGARDING YOUR VIDEO MONITOR COMPATIBILITY WITH THIS UNIT, PLEASE CONTACT OUR CUSTOMER SERVICE CENTER.

This unit is compatible with the complete line of YAMAHA projectors, including the DPX-1, LPX-500, PDM-1 and DPX-1000.

DVD-Audio features DVD-A

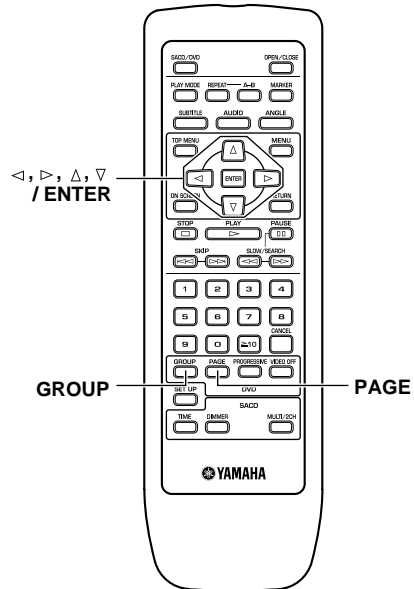

■ Playing a track in a specific group

- 1** Press **GROUP**.
The video monitor displays group and track icons.
 - 2** Press the cursor buttons (**UP**, **DOWN**) to select a group number, then press **ENTER**.
 - 3** Press the cursor buttons (**UP**, **DOWN**) to select a track number, then press **ENTER**.
The selected track starts to play.
- You can also use the numeric buttons to select a group and a track.

■ Playing bonus groups
Some discs contain bonus groups that require a four-digit password to gain access. In this case, consult the disc jacket and other packaging for information.

- 1** While playback is stopped, press **GROUP**.
The video monitor displays group and track icons.
- 2** Press the cursor buttons (**UP**, **DOWN**) to select a bonus group, then press **ENTER** or the cursor button (**RIGHT**).
- 3** Enter a four-digit password using the numeric buttons, then press **ENTER**.
- 4** Press the cursor buttons (**UP**, **DOWN**) to select a track, then press **ENTER**.

■ Changing pages

DVD-Audio discs can contain information pages that can include photo galleries, artist biographies, lyrics, etc. Press PAGE to turn the page. (The page number will update on the display when you change pages.)

Switching audio tracks, subtitles and angles

DVD-A DVD-V VCD

Some discs are encoded with several audio tracks, multi-lingual subtitles or multiple camera angles. Refer to the disc jacket to learn which features are supported.

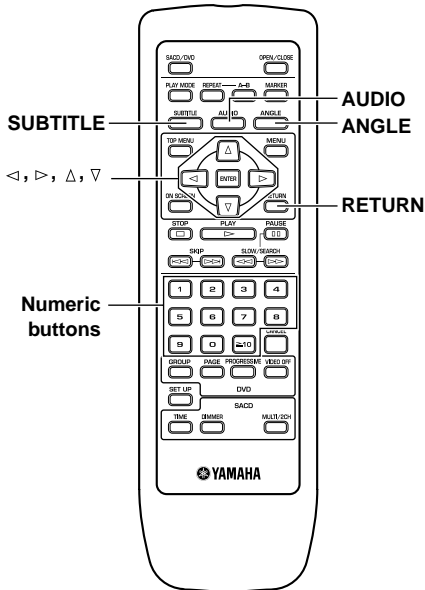

■ Changing audio tracks

You can select different audio track languages and/or formats, if they are available on a disc.

Press AUDIO during playback.

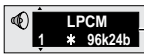

This icon appears on the video monitor.

- Press AUDIO repeatedly to step through all audio tracks on a disc. The cursor buttons (▲, ▼) and the numeric buttons also change tracks.



- If you change audio tracks while playing a non-video portion of a DVD-Audio disc, playback begins at the beginning of the track.
- On a DVD-Audio disc, track 2 appears on the front display even if the disc contains only one audio track.
- You can also use the button to turn the vocals on or off on karaoke discs. See the disc instructions for details.

■ Selecting a subtitle language

Press SUBTITLE during playback.



This icon appears on the video monitor.

- Press SUBTITLE repeatedly to step through all subtitles on the disc. The cursor buttons (▲, ▼) and the numeric buttons also change subtitles.



- “- -” is displayed if a disc does not include a subtitle.

Note

- Subtitles may not be displayed immediately.

Turning subtitles on or off

1 Press SUBTITLE.

2 Press the cursor button (▶).

(DVD-A , DVD-V ONLY)

3 Press the cursor buttons (▲, ▼) to select ON or OFF.

■ Changing angles

Press ANGLE.



This icon appears on the video monitor.

- Press ANGLE repeatedly to step through all angles recorded on the disc. The cursor buttons (▲, ▼) and the numeric buttons also change angles.

■ Turning the icons off

Press RETURN.

Note

- Certain discs require that you use a disc menu to change audio tracks, subtitles or angles.

Program play SACD DVD-A VCD CD

Enjoy listening to your favorite tracks in any order. This unit enables you to program sequence for up to 32 tracks from disc.

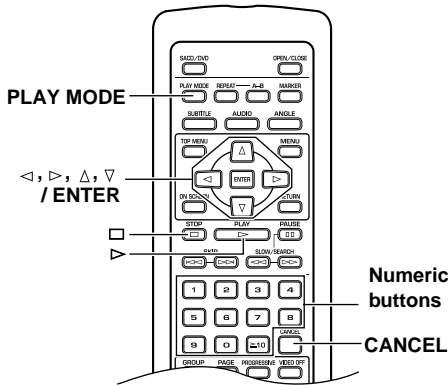

- 1** Press to stop playback.
- 2** Press **PLAY MODE** repeatedly to select the program screen.

DVD-A VCD CD

Each time you press **PLAY MODE**, the screen changes as follows:

Video monitor display (example)

Program screen (Program play mode)
Playing in desired order

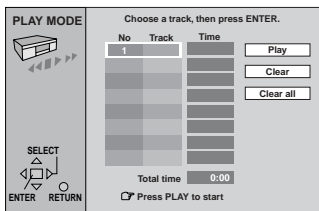

↓
Random screen (Random play mode)
Playing in random sequence
↓
Return to normal playback

SACD

Press the button repeatedly to light up the indicators in the following order:

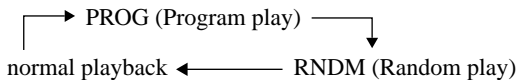

Example: (Program play)

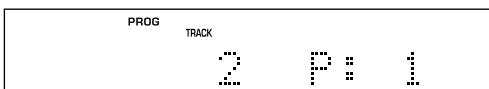

Note

- On combination discs (which include 2-channel and multi-channel areas), you can program tracks only in the currently-selected area.

- 3** Press numeric buttons to select the track.

- 4** Press to start playback.



- You can also use numeric buttons to select a group or track.

DVD-A

- The “All group play” screen (playback of all groups in order) is added to step 2.
- In step 4, press the cursor buttons (Δ, ∇) to select a group, then press ENTER. Press the cursor buttons (Δ, ∇) again to select a track, then press ENTER.

Changing or adding to the program during program play

- 1** Press repeatedly to stop program play.
- 2** Press the cursor buttons (Δ, ∇) to select the desired track order position.
- 3** Press the numeric buttons to enter a track number.

Canceling programmed tracks

- 1** Press repeatedly to stop program play.
- 2** Press the cursor buttons (Δ, ∇) to select a track to cancel.
- 3** Press **CANCEL**.

Note

- If you program a Video CD track (ver. 2.0), playback control is canceled during program play.

Navigating up and down pages on the program screen

Press to move up the page, or press to move down the page.

Exiting programming mode

- 1** Press repeatedly to stop program play.
- 2** Press **PLAY MODE** twice.
 - Turning off the power or opening the disc tray will cancel all programs.

Random play SACD DVD-A VCD CD

In random play mode, the unit plays all tracks on the disc in random order.

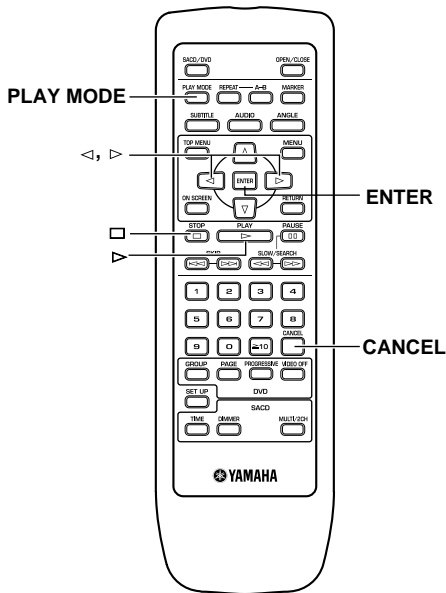

1 Press \square to stop playback.

2 Press **PLAY MODE** repeatedly.

The “RNDM” indicator lights up on the front panel display.

3 Press \triangleright to start random play.

■ Canceling random mode

1 Press \square repeatedly to stop playback during random play.

2 Press **PLAY MODE**.

The “RNDM” indicator disappears.

- Opening the disc tray also cancels this mode.

Notes

- When the unit is in random mode, Video CD playback control is canceled.
- Up to 100 tracks can be programmed for SACD random play.

DVD-A

In step 2 of “Random play,” press the cursor buttons (\triangleleft , \triangleright) to select a group, then press ENTER.

Example: DVD-Audio (a disc with up to two groups)

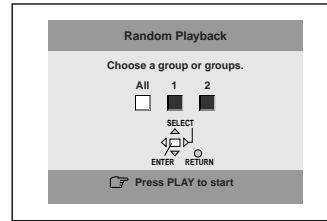

- You can select multiple groups.
- Use the numeric buttons to select a group.

To cancel a selection, press the cursor buttons (\triangleleft , \triangleright) to select the group(s), then press CANCEL or ENTER.

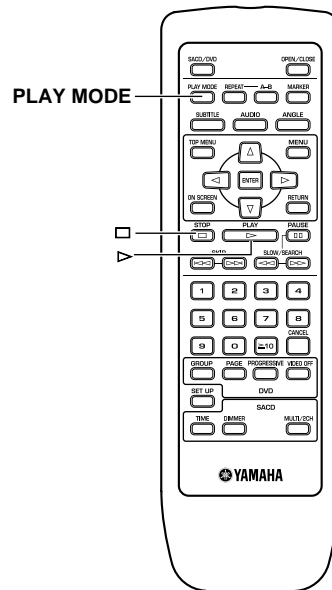

- You can also cancel a group by entering its group number using the numeric buttons.

All group play DVD-A

1 Press \square to stop playback.

2 Press **PLAY MODE**.

3 Press \triangleright .

Bookmarks DVD-A DVD-V VCD CD

The Bookmark feature allows you to mark up to five points (locations), enabling you to return quickly to those points.

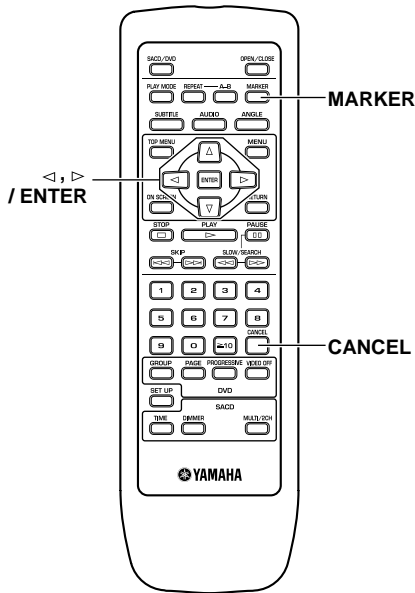

Repeat play

SACD DVD-A DVD-V VCD CD

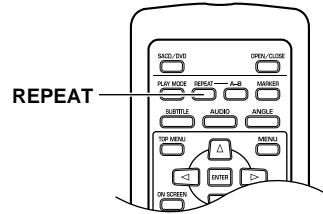

To select Repeat mode, during playback press REPEAT.

Each time you press the REPEAT button, the repeat mode changes as follows.

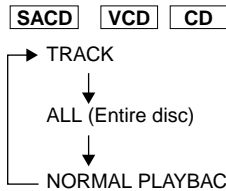
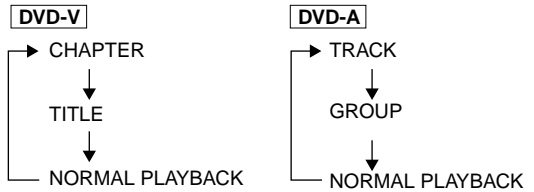

1 Press MARKER.

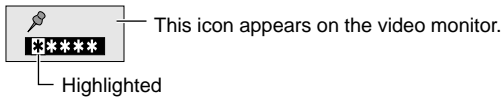

2 Press the cursor buttons (<, >) to select one of five asterisks.
The selected asterisk is highlighted.

3 Press ENTER.

The selected asterisk changes to the bookmark number.



■ Playing from a marked point

Press the cursor buttons (<, >) to select a bookmark number, then press ENTER.

■ Clearing a bookmark

Press the cursor buttons (<, >) to select a bookmark number, then press CANCEL.

Note

- When you open the disc tray or turn the unit off, all bookmarks are cleared.

During repeat play, the following indicators light up:

	Indicators on the monitor	Indicators on the unit display
CHAPTER	C	REP
TITLE	T	REP
TRACK	T	REP
ALL	A	REP, ALL
GROUP	G	REP

The selected repeat mode name scrolls across the multi-information display.

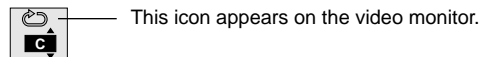

Notes

- Repeat play may not work properly on all DVD-Video discs.
- Repeat play may not work during menu play of VCDs that feature playback control.
- For Super Audio CDs, only the indicators on the unit's display will light up.
- If you select "All" repeat for a disc that has a 2-channel area and a multi-channel area, only tracks in the currently-selected area will repeat.

■ Program repeat

SACD DVD-A VCD CD

During program play, press REPEAT.

Each time you press REPEAT, the repeat mode changes as follows:

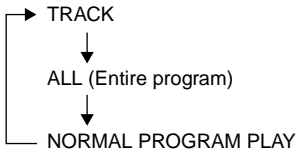

- The selected repeat mode is indicated on the unit's display and on the monitor (for DVD-Audio, video CD, and audio CD).

■ Random-sequence repeat

SACD DVD-A VCD CD

During random play, press REPEAT.

Each time you press REPEAT, the repeat mode changes as follows:

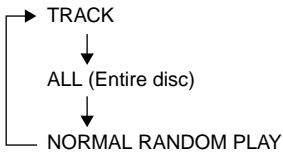

- The selected repeat mode is indicated on the unit's display and on the monitor (for DVD-Audio, video CD, and audio CD).

Repeat A-B

SACD DVD-A DVD-V VCD CD

The repeat A-B function enables you to specify two points and repeatedly play the section between them.

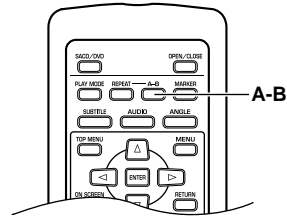

1 During playback, press A-B at the desired start point (A).



This icon appears on the video monitor.

- “REP” and “A-” light up and “B” flashes on the front panel display.

2 Press A-B at the desired end point (B).



This icon appears on the video monitor.

- The flashing “B” lights up steadily on the front panel. The section between points A and B starts playing repeatedly (looping).

■ Canceling A-B repeat

Press A-B.



This icon appears on the video monitor.

Notes

- This function may be unavailable on certain DVD-Video discs.
- This function works only within a title or track.
- With Super Audio CDs, the icon appears only on the unit's display.

ON-SCREEN MENU (DVD MODE ONLY)

You can control various items using the on-screen menu bar.

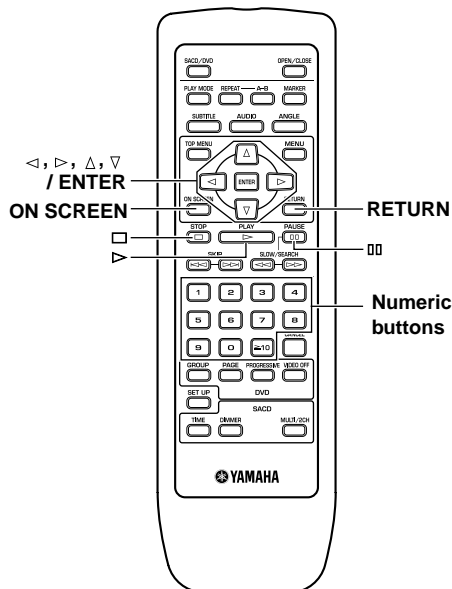

The Player Info bar includes four menu bars, as illustrated below. To switch menu bars, press the cursor buttons (Δ, ∇).

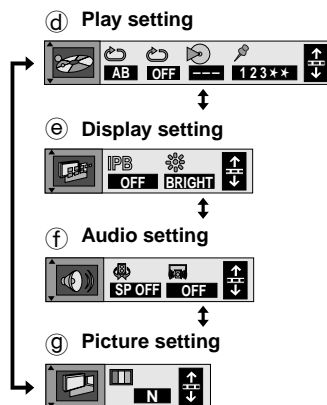

Operating the menu bar

1 Press ON SCREEN.

Each time you press ON SCREEN, the on-screen bar changes as follows:

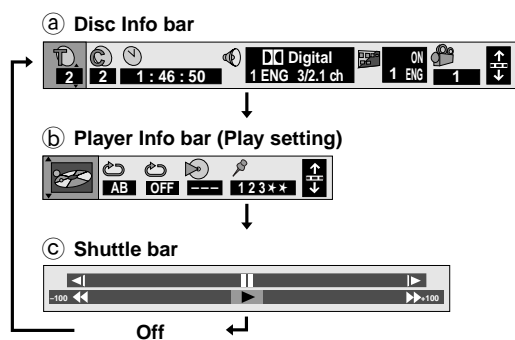

2 Press the cursor buttons (◀, ▶) to select an item to adjust.

The selected item is highlighted.

3 Press the cursor buttons (Δ, ∇, ◀, ▶) to adjust the setting.

- Certain items may require that you press ENTER or ▶ to execute the setting.
- You can also use the numeric buttons to specify a chapter number, etc.

Turning the screen off

Press RETURN repeatedly.

Note

- Certain items are inaccessible when playback is stopped.

Changing the menu bar position

To adjust the menu bar position:

1 Press the cursor buttons (◀, ▶) to select the right-most icon (⏏).

Example)



2 Press the cursor buttons (Δ, ∇) to move the menu bar.

Disc Info bar

Example: DVD-Video



	Title number DVD-V Track number DVD-A VCD CD
	Chapter number DVD-V
	Group number DVD-A
	Time index (hour:minute:second) DVD-A DVD-V 1:46:50 You can start playback from a specific point by keying in the elapsed time. For example, to start playback from 1:46:50 (1 hr 46 min 50 sec), press these buttons in the following order: [1]→[4]→[6]→[5]→[0]→[ENTER] Changing the time display DVD-A VCD CD (for display only) Track elapsed time ↑↓ Track remaining time ↑↓ Disc remaining time
	Audio mode VCD Select a channel to output sound from that channel. LR ↔ L ↔ R
	Audio format DVD-A DVD-V ① Audio track number ② Audio track/language: See [A] for language abbreviations. ③ Audio signal type: See [B] for details.

Notes

- The display may vary in accordance with disc specifications.
- The time remaining on the disc does not appear during program play or random play.
- When playing a Video CD disc using playback control, no track number or time is displayed.

	Karaoke vocal on/off DVD-A DVD-V (Karaoke DVD only) Solo: OFF or ON Duet: OFF, V1+V2, V1 or V2
	Subtitle on/off DVD-A DVD-V ① Subtitle on/off ② Subtitle language Select a number to display the desired subtitle language.
	Angle number DVD-A DVD-V Select an angle number to play the scene from that angle.
	Playback control Indicates whether playback control is on or off. VCD Playback control cannot be adjusted.
	Page number DVD-A Select a page number to display the page.

[A] Language

ENG: English	SVE: Swedish	CHI: Chinese
FRA: French	NOR: Norwegian	KOR: Korean
DEU: German	DAN: Danish	MAL: Malay
ITA: Italian	POR: Portuguese	VIE: Vietnamese
ESP: Spanish	RUS: Russian	THA: Thai
NLD: Dutch	JPN: Japanese	*: Others

[B] Signal type/data

LPCM/PPCM Dolby Digital/DTS/MPEG: Signal type
 k (kHz): Sampling frequency
 b (bit): Number of bits
 ch (channel): Number of channels

Example:

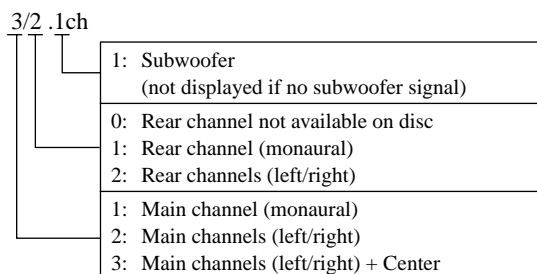





Player Info bar

■ Play setting

Example: DVD-Video





	A-B repeat (see page 19) <input type="button" value="DVD-A"/> <input type="button" value="DVD-V"/> <input type="button" value="VCD"/> <input type="button" value="CD"/> [ENTER] (start point)→[ENTER] (finish point)→[ENTER] (playback) To cancel [ENTER]
	Repeat play (see page 18) <input type="button" value="DVD-V"/> C: Chapter; T: Title; OFF: Normal playback <input type="button" value="DVD-A"/> <input type="button" value="VCD"/> <input type="button" value="CD"/> T: Track; A: All; G: Group; OFF: Normal playback
	Play mode display <input type="button" value="DVD-A"/> <input type="button" value="VCD"/> <input type="button" value="CD"/> (for display only) RND: Random play; PGM: Program play; ---: Normal playback ALL: All groups <input type="button" value="DVD-A"/>
	Bookmarks (see page 18) <input type="button" value="DVD-A"/> <input type="button" value="DVD-V"/> <input type="button" value="VCD"/> <input type="button" value="CD"/> You can mark up to five (5) places to play again. To mark a point: [◀, ▶]→[ENTER] (at the desired point) To recall a bookmark: [◀, ▶]→[ENTER] To erase a bookmark: [◀, ▶]→[CANCEL]

■ Display setting

Example: DVD-Video





	IPB display <input type="button" value="DVD-V"/> I, P, and B indicate still picture types. Type I pictures are the largest (in data size), followed by types P and B. Type I pictures offer the highest picture quality. ON ↔ OFF
	Display dimmer Changes the brightness of the front panel display. BRIGHT ↔ DIM ↔ AUTO ↑ Select AUTO to dim the front panel display when a disc containing video is played. Pressing PAUSE will brighten the front panel temporarily.

■ Audio setting

Example: DVD-Video



	Virtual Surround (<input type="button" value="V.S.S."/> , <input type="button" value="DVD-V"/> , <input type="button" value="VCD"/>) <ul style="list-style-type: none"> • Speaker V.S.S (SP-V.S.S.) Dolby Digital, DTS, MPEG, LPCM Two or more-channel discs • Headphone V.S.S (HP-V.S.S.) Dolby Digital, MPEG, LPCM Two or more-channel discs V.S.S. level SP 1/HP1: standard SP 2/HP 2: high SP off/HP off: V.S.S. canceled
	Cinema dialog <input type="button" value="DVD-V"/> (Dolby Digital/DTS 3ch or more channel discs) Select ON to increase the volume of dialog output from the center channel.

Picture setting



	<p>Digital picture mode DVD-A DVD-V VCD</p> <p>N: Normal C: Cinema image (suited for movie viewing) U: User mode</p> <p>To change the User mode: ① Select User mode. ② Press (<, >) to select an item to change. ③ Press (Δ, ∇) to adjust the setting. The following items are displayed when you select "U."</p>
	<p>U Contrast (-7 to +7) Adjusts the contrast between the light and dark areas of the picture.</p>
	<p>Brightness (0 to +15) Adjusts the overall brightness of the picture.</p>
	<p>Sharpness (-6 to +6) (U.K., European, and Australian models) Adjusts the horizontal resolution of the picture.</p>
	<p>Color (-7 to +7) Adjusts the picture color.</p>

When PROGRESSIVE is on (U.S.A. model)



	<p>Digital picture mode DVD-A DVD-V VCD</p> <p>N: Normal C: Cinema image (suited for movie viewing)</p>
	<p>Transfer MODE Selects the method of converting film material (recorded at 24fps) or video material (recorded at 30fps) into progressive output. Auto (normal): For viewing film material Video: For viewing video material</p>

Shuttle bar

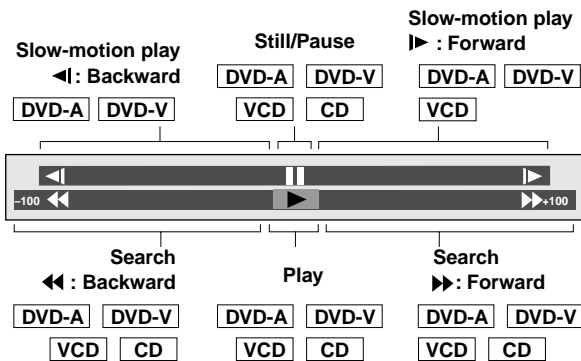

Note

- On DVD-Audio discs, slow-motion works only on the video portion.

CHANGING THE DVD MODE SETTINGS

The Setup menu enables you to change the factory default settings.

Using the Setup menu

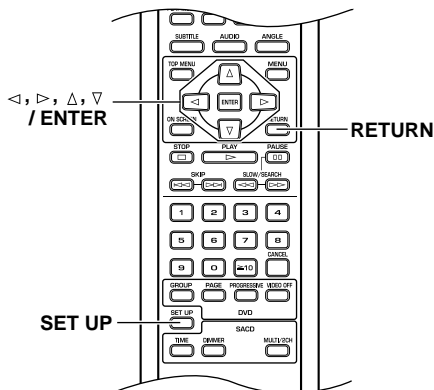

1 Press **SETUP**.

The video monitor displays a menu.

2 Press the cursor buttons ($\triangleleft, \triangleright$) to select a menu group.

There are five menu groups. The screen displays items that belong to the selected menu group.

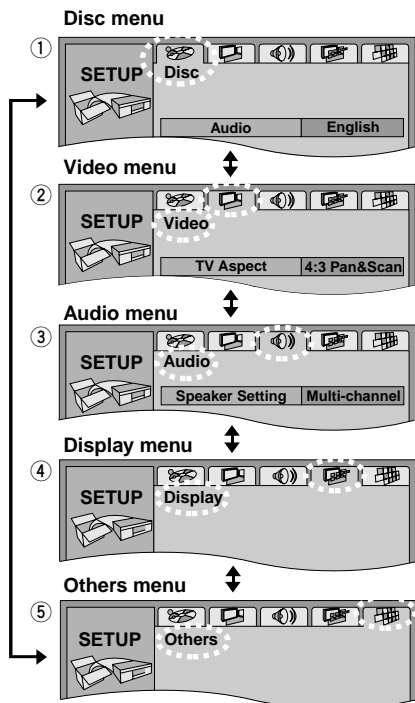

3 Press the cursor buttons (\triangle, ∇) to select the desired item, then press **ENTER**.

4 Press the cursor buttons (\triangle, ∇) to change the setting, then press **ENTER** again to return to the screen illustrated in step 2.

Returning to the previous screen

Press **RETURN**.

Exiting Setup mode

Press **SETUP**.

Note

- When you display the Setup menu, the **DISC DIRECT** function turns on automatically. When you exit the Setup menu, the **DISC DIRECT** function returns to the previous setting.

Returning all settings on the Setup menu to factory defaults

Press and hold down \triangle, \square , and $\triangleleft, \triangleleft$ on the front panel simultaneously until the video monitor displays "Initialized."

Settings Summary

The following chart shows Menu groups, Items, and Options. Factory default settings are underlined.

Menu groups	Items	Options
Disc	Audio <input type="checkbox"/> DVD-A <input type="checkbox"/> DVD-V Select the preferred audio track language.	(U.S.A. model): <u>English</u> / French / Spanish / Original* / Other** (Australian model): <u>English</u> / French / German / Italian / Spanish / Original* / Other** (U.K. and European models): <u>English</u> / French / German / Italian / Spanish / Original* / Other**
	Subtitle <input type="checkbox"/> DVD-A <input type="checkbox"/> DVD-V Select the preferred subtitle language.	(U.S.A. model): <u>Automatic</u> / English / French / Spanish / Other** (Australian model): <u>Automatic</u> / English / French / German / Italian / Spanish / Other** (U.K. and European models): <u>Automatic</u> / English / French / German / Italian / Spanish / Other**
	Menus <input type="checkbox"/> DVD-A <input type="checkbox"/> DVD-V Select the preferred disc menu language.	(U.S.A. model): <u>English</u> / French / Spanish / Other** (Australian model): <u>English</u> / French / German / Italian / Spanish / Other** (U.K. and European models): <u>English</u> / French / German / Italian / Spanish / Other**
	Ratings <input type="checkbox"/> DVD-V Set a ratings level to limit DVD-Video playback. See page 28 for details.	Setting ratings level <u>8 No Limit</u> / 1 to 7 / 0 Lock All Changing ratings level Unlock Player Change Level Change Password Temporary Unlock
Video	TV Aspect If you connect to a 4:3 conventional-type monitor, select "4:3 Pan&Scan" (left and right sides trimmed when playing 16:9 video) or "4:3 Letterbox" (black areas appear at the top and bottom when playing 16:9 video). Select "16:9" if you connect to a widescreen monitor.	4:3 <u>Pan&Scan</u> : On a conventional monitor, the video image fills the monitor screen but is trimmed on its left and right sides. / 4:3 Letterbox: On a conventional monitor, black areas appear at the top and bottom of the screen when playing 16:9 video. / 16:9: For a widescreen monitor
	AV Output (U.K. and European models) Choose the video signal format to be output from the AV1 SCART jack.	Video / S-Video / RGB

Menu groups	Items	Options
Video	Still Mode Specify the type of picture shown in pause mode. First select "Automatic." If still pictures jitter, select "Field." If visual details are still not clear, select "Frame."	<u>Automatic</u> / Field / Frame A moving picture is composed of numerous still images called frames. Each frame is composed of two alternating fields. Each fields contains only half the information of a still frame. Two alternating fields may result in a blurred frame. In general, set Still Mode to "Automatic."
	Black Level Control (U.S.A. model) Change the black level of the picture. Select "Lighter" when you connect to a monitor using the VIDEO or S VIDEO jacks. Select "Darker" when using COMPONENT output.	<u>Lighter</u> / Darker
	NTSC Disc Output (U.K., European and Australian models) Select a video signal format (PAL 60 or NTSC) to be output when playing an NTSC disc.	<u>PAL 60</u> / NTSC
Audio	Speaker Setting <input type="checkbox"/> DVD-A <input type="checkbox"/> DVD-V Set the parameters for the analog audio output (6CH DISCRETE or MIXED 2CH) to suit your speaker system.	<u>Multi-channel</u> : If 6CH DISCRETE output is being used. (Also, select the speakers, speaker size, delay time, and channel balance. See page 29.) 2-channel: If MIXED 2CH output is being used.
	PCM Down Conversion <input type="checkbox"/> DVD-A <input type="checkbox"/> DVD-V Specify how to output high sampling-frequency audio signals from discs that are not copyright-protected. (See page 28 for details.)	<u>No</u> / Yes
	Dolby Digital <input type="checkbox"/> DVD-A <input type="checkbox"/> DVD-V Specify the signal type output from the unit's digital outputs. Select "Bitstream" if the connected device features a Dolby Digital decoder. Select "PCM" otherwise.	<u>Bitstream</u> / PCM
	DTS Digital Surround <input type="checkbox"/> DVD-A <input type="checkbox"/> DVD-V Specify the signal type output from the unit's digital outputs. Select "Bitstream" if the connected device features a DTS decoder. Select "PCM" otherwise.	<u>Bitstream</u> / PCM
	MPEG <input type="checkbox"/> DVD-A <input type="checkbox"/> DVD-V (U.K., European and Australian models) Specify the signal type output from the unit's digital outputs. Select "Bitstream" if the connected device features an MPEG decoder. Select "PCM" otherwise.	Bitstream / <u>PCM</u>
	D. Range Compression <input type="checkbox"/> DVD-A <input type="checkbox"/> DVD-V (Dolby Digital only) Change the dynamic range for late-night viewing. Select "On" to make it easier to hear dialog at low volume levels.	<u>Off</u> / On
	Audio during Search <input type="checkbox"/> DVD-A <input type="checkbox"/> DVD-V <input type="checkbox"/> VCD Select to enable sound during search. Select "Off" if the sound is distorted when searching with Dolby Digital or DTS material. With DVD-Audio, sound may be heard even if you select "Off."	<u>On</u> / Off

Menu groups	Items	Options
Display	On-Screen Menu Language Select the preferred language for the Setup menu and on-screen messages.	(U.S.A. model): <u>English</u> / Français / Español (Australian model): <u>English</u> / Français / Deutsch / Italiano / Español (U.K. and Europe models): <u>English</u> / Français / Deutsch / Italiano / Español
	On-Screen Messages Select whether or not to show on-screen messages.	<u>On</u> / <u>Off</u>
Others	DVD-Video Mode Some DVD-Audio discs contain DVD-Video content that can be played only by a DVD-Video player.	<u>On</u> / <u>Off</u> To play DVD-Video content, select "On." To play a normal DVD-Audio disc, select "Off."
	Demo A demonstration of the unit's on-screen displays starts when you select "On". The demonstration stops when you press the <input type="checkbox"/> button, etc. The setting reverts to "Off".	<u>On</u> / <u>Off</u>

- * If you set Audio to "Original," the original language of each disc will be selected.
- ** If you set Audio, Subtitle, or Menus to "Other," specify the language by selecting a four-digit number from the language code list and enter it using the numeric buttons.
- *** If the audio language you select is not recorded on the disc, but subtitles for the same language are recorded, the subtitles will be displayed. However, if the audio is recorded on the disc, the subtitles will not be displayed.

■ Language selection and language code list

Language code list			
6565: Afar	7079: Faroese	7678: Lingala	8375: Slovak
6566: Abkhazian	7082: French	7679: Laotian	8376: Slovenian
6570: Afrikaans	7089: Frisian	7684: Lithuanian	8377: Samoan
6577: Ameharic	7165: Irish	7686: Latvian, Lettish	8378: Shona
6582: Arabic	7168: Scots Gaelic	7771: Malagasy	8379: Somali
6583: Assamese	7176: Galician	7773: Maori	8381: Albanian
6588: Aymara	7178: Guarani	7775: Macedonian	8382: Serbian
6590: Azerbaijani	7185: Gujarati	7776: Malayalam	8385: Sundanese
6665: Bashkir	7265: Hausa	7778: Mongolian	8386: Swedish
6669: Byelorussian	7273: Hindi	7779: Moldavian	8387: Swahili
6671: Bulgarian	7282: Croatian	7782: Marathi	8465: Tamil
6672: Bihari	7285: Hungarian	7783: Malay	8469: Telugu
6678: Bengali; Bangla	7289: Armenian	7784: Maltese	8471: Tajik
6679: Tibetan	7365: Interlingua	7789: Burmese	8472: Thai
6682: Breton	7378: Indonesian	7865: Nauru	8473: Tigrinya
6765: Catalan	7383: Icelandic	7869: Nepali	8475: Turkmen
6779: Corsican	7384: Italian	7876: Dutch	8476: Tagalog
6783: Czech	7387: Hebrew	7879: Norwegian	8479: Tonga
6789: Welsh	7465: Japanese	7982: Oriya	8482: Turkish
6865: Danish	7473: Yiddish	8065: Punjabi	8484: Tatar
6869: German	7487: Javanese	8076: Polish	8487: Twi
6890: Bhutani	7565: Georgian	8083: Pashto, Pushto	8575: Ukrainian
6976: Greek	7575: Kazakh	8084: Portuguese	8582: Urdu
6978: English	7576: Greenlandic	8185: Quechua	8590: Uzbek
6979: Esperanto	7577: Cambodian	8277: Rhaeto-Romance	8673: Vietnamese
6983: Spanish	7578: Kannada	8279: Romanian	8679: Volapük
6984: Estonian	7579: Korean	8285: Russian	8779: Wolof
6985: Basque	7583: Kashmiri	8365: Sanskrit	8872: Xhosa
7065: Persian	7585: Kurdish	8368: Sindhi	8979: Yoruba
7073: Finnish	7589: Kirghiz	8372: Serbo-Croatian	9072: Chinese
7074: Fiji	7665: Latin	8373: Singhalese	9085: Zulu

Note

- The language selected in the Setup menu cannot be heard if it is not present on the disc.

Ratings DVD-V

The ratings level can be set from 0 through 8. (The lower the number, the greater the restriction.)

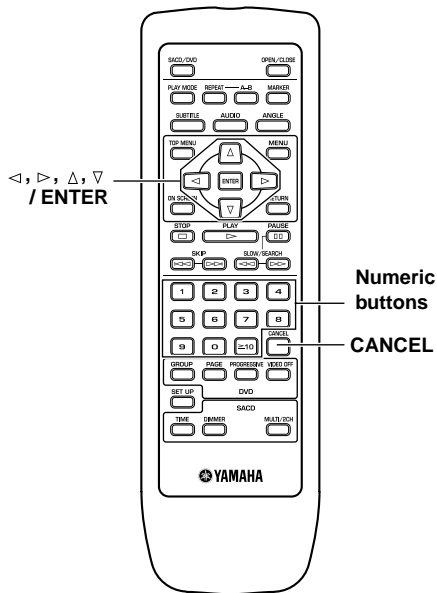

Changing the ratings level (from Level 8)

The unit may be set so that it will not play DVD videos unsuitable for children. To play these videos or change the restriction, you must enter a password.

When you select level 0 through 7, the unit displays the password screen.

1 Press SETUP.

The video monitor displays a menu.

2 Press ∇ to select "Ratings," then press ENTER.

3 Enter a four-digit number using the numeric buttons, then press ENTER.

Press CANCEL to enter a different number. Remember your password!

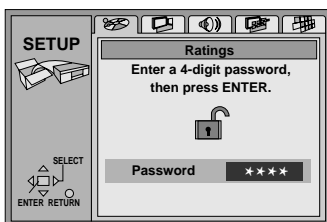

4 Press ENTER.

The password is confirmed and the lock icon is engaged. If you attempt to play a disc that exceeds the ratings level, a message will appear on the video monitor. Follow the procedure described on screen. (Press ENTER to display the previous screen.)

Changing the ratings level (from Levels 7 - 0)

Select "Ratings" in the Setup menu to display the password screen.

1 Enter a four-digit number using the numeric buttons, then press ENTER.

The following items are displayed:

Unlock Player: Unlocks the rating; returns to level 8.

Change Password: Changes the password.

Change Level: Changes the rating level.

Temporary Unlock: Temporarily unlocks the rating level. It remains unlocked until you turn the power off or open the disc tray.

2 Press the cursor buttons (Δ, ∇) to select the desired item, then press ENTER.

If you forget your password

Return the unit to its factory default settings. See page 24.

Note

- All other settings return to factory defaults.

PCM down conversion DVD-A DVD-V

You can specify how to output high-quality digital signals (sampling frequencies of 88.2kHz and 96kHz) from discs that are not copyright-protected. Select an option depending on whether the connected amplifier or other components support these signals.

Connected component supports 88.2kHz or higher signals.	PCM down conversion	Digital output
Yes	Select "Yes."	Output as is.
No	Select "No."	Converted to 48kHz or 44.1kHz.

If a digital signal is input to a component that does not support 88.2kHz or higher signals, select "Yes." (If you select "No," audio signals of 88.2kHz or higher sampling frequencies will not be output.)

Note

- If a disc is copyright-protected or has a sampling frequency of 176.4 kHz or more, signals are automatically converted to either 48 kHz or 44.1 kHz.

Speaker settings DVD-A DVD-V

Set the parameters for 6CH DISCRETE output to suit the speaker system.

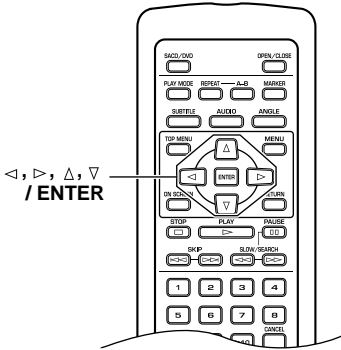

If you select “Multi-channel” from the Setup menu, set parameters (a), (b), and (c) (page 29 and page 30) according to the speaker system.

Setting panel

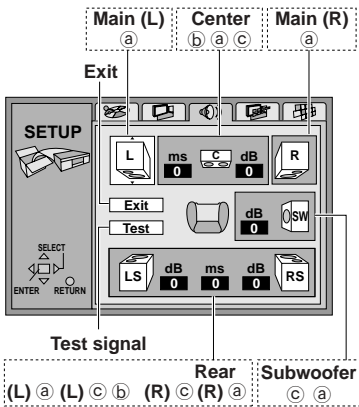

Ⓐ Speaker selection and size

1 Press the cursor buttons (Δ, ∇, <, >) to select a speaker, then press ENTER.

The indicator ◆ is displayed above and below the speaker icons.

2 Press the cursor buttons (Δ, ∇) to select a setting, then press ENTER.

- Speaker size options:
 - L: Large, Small
 - R: Large, Small
 - C: Large, Small, None
 - SW: Used, Not used
 - LS: Large, Small, None
 - RS: Large, Small, None

The left (L or LS) speaker size is automatically assigned to the right (R or RS) speaker. (For example, if you select Large for the L speaker, the R speaker will automatically be set to Large.)

- Example: Left rear speaker

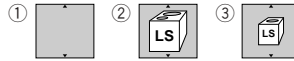

- ① No icon appears when the speaker is not used.
- ② This icon appears when using a large speaker capable of low-frequency (under 100 Hz) output.
- ③ This icon appears when using a small speaker that is not capable of low-frequency output.

- Factory default speaker-size settings:
 - L/R: Large
 - C/LS/RS: Large
 - SW: Used

ⓑ Delay time

(This parameter is effective on only center/rear channels of DVD-Video discs recorded in Dolby Digital format.) To obtain maximum effect from a Dolby Digital 5.1 channel source, all speakers (except the subwoofer) should be located the same distance from the listening position. However, the center speaker is often placed in line with the front speakers. You can virtually increase the distance of the center and rear speakers by adjusting the delay time.

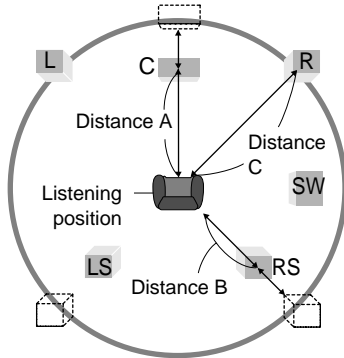

1 Press the cursor buttons (▲, ▼, ◀, ▶) to select an “ms” box, then press ENTER.

2 Press the cursor buttons (▲, ▼) to adjust the delay time, then press ENTER.

- If Distance A or B in the above illustration is equal to or greater than Distance C, set the delay time to 0 ms.
- If Distance A or Distance B is less than Distance C, set the delay time as follows:

Center speaker

Difference	Setting
Approx. 50 cm (1 1/2 feet)	1.3 ms
Approx. 100 cm (3 feet)	2.6 ms
Approx. 150 cm (5 feet)	3.9 ms
Approx. 200 cm (6 feet)	5.3 ms

Rear speakers

Difference	Setting
Approx. 200 cm (6 feet)	5.3 ms
Approx. 400 cm (12 feet)	10.6 ms
Approx. 600 cm (18 feet)	15.9 ms

ⓒ Speaker balance

You can use the test tone to adjust the output level of each speaker (center, rear L/R) until the volume level of each speaker matches the main speakers.

1 Press the cursor buttons (▲, ▼, ◀, ▶) to select “Test,” then press ENTER.

The test tone plays through one speaker at a time in the following order, starting with the left front speaker.

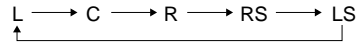

2 Listening to the test tone, press the cursor buttons (▲, ▼) to adjust the volume of the effect speakers (from -6db to +6db), then press ENTER.

The value in the “dB” box changes.

You cannot adjust the main speaker level.

Note

- The subwoofer cannot output the test tone. Play a recording and return to this screen to adjust the output level of the subwoofer.

■ Exiting speaker setting mode

Press the cursor buttons (▲, ▼, ◀, ▶) to select “EXIT,” then press ENTER.

Notes

- You must make separate settings for SACD mode (see page 31).
- These adjustments may not be effective when the disc’s original sound design is protected. In this case, the P.PCM indicator will light up or the D.MIX indicator will turn off.

CHANGING THE SACD MODE SETTINGS

This unit features independent playback circuits for DVD mode and SACD mode. DVD mode settings are not valid in SACD mode. You must complete a separate group of settings dedicated to SACD mode.

Speaker settings

To play multi-channel Super Audio CD data effectively, set the speaker parameters in SACD mode to suit your speakers and components. The speaker parameters enable you to select a speaker mode and adjust the speaker balance.

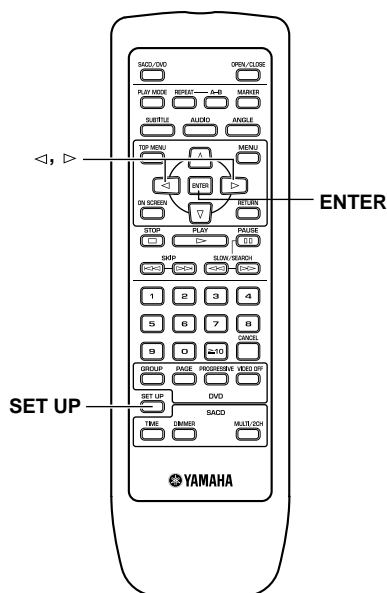

Setting speaker mode

Set the speaker mode according to your speaker size and setup.

1 Press SETUP.

The unit displays “SPK MODE.”

2 Press ENTER.

The unit displays the current setting.

3 Press the cursor button < or > to change the setting.

When you press the cursor button, the speaker mode setting (indicated on the display) changes as follows:

Speaker mode chart

Speaker mode	Main speakers	Center speaker	Rear speakers	Sub-woofer
MLTCH DIRECT	Audio signals are output as recorded.			
5-LRG	Large	Large	Large	None
5-SML +SW	Small	Small	Small	Used
MAIN-LRG +SW	Large	Small	Small	Used
MAIN-LRG	Large	Small	Small	None
NON-C +SW	Large	None	Large	Used
NON-C	Large	None	Large	None

Selecting a speaker mode:

Select a speaker mode to suit your speaker setup and performance. Speakers marked “Large” will output all signals, including a low range of 90Hz and lower. If you are using a large speaker with a large capacity for low-range frequencies (i.e., the woofer diameter is 16cm or more), select a mode for which the corresponding speaker is marked “Large.” The low range on the “Small” speaker channels is output to the sub-woofer or main speakers (marked “Large”). If you feel that low range playback is not sufficiently powerful, or if the sound clips, select a mode in which the corresponding speaker is marked “Small.”

4 Press ENTER to confirm the selected mode.

5 Press SETUP.

The unit displays the standard screen.

Adjusting the speaker balance

If the volume level of each speaker varies, use the test tone to adjust the level so that all speakers sound at the same level as the main speakers.

- The speaker balance cannot be adjusted if the speaker mode is set to MLTCH DIRECT.
- If the speaker mode is changed, parameters set prior to the change will be initialized (assigned as initial values).

1 Press SETUP.

2 Press the cursor button < or > to select “SPK BALANCE.”

Pressing the cursor button toggles between “SPK MODE” and “SPK BALANCE.”

3 Press ENTER.

The unit displays “TEST TONE.”

4 Press ENTER.

Two seconds of test tone are output from each speaker in the following order.

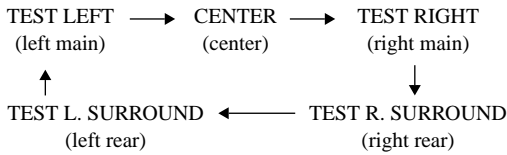

5 Press ENTER to stop the test tone, press the cursor button < or > to select a speaker to adjust, then press ENTER again.

Pressing the cursor button < or > steps through the display indication as follows:

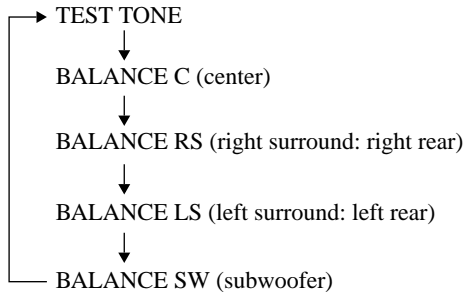

Example: Adjusting the right rear speaker level
 Select BALANCE RS, then press ENTER. The unit displays the following indication, and the left and right main speakers and the right rear speaker output a test tone at the same time.



Notes

- You cannot adjust the level of the main speakers. Instead, you adjust the level of the center, left and right rear speakers based on the level of the main speakers.
- No test tone is output from speakers marked “None” in the selected speaker mode (see the speaker mode chart on page 31). In this case, you will be unable to adjust the level.

6 Press the cursor button < or > to adjust the level balance.

Press the cursor button to move “+” one step. Press > to increase or < to decrease the selected speaker level relative to the main speaker level.



- One step equals 0.5dB.

7 Press ENTER to confirm the setting.

The unit displays the next speaker’s balance setting.

8 Press SETUP.

The unit displays the standard screen.

Adjusting the brightness of the display

You can adjust brightness of the display.

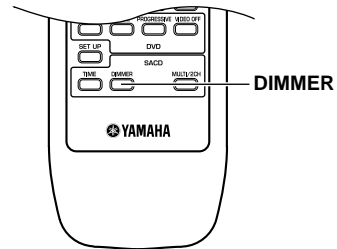

Press DIMMER.

Each time you press DIMMER, the brightness changes as follows:

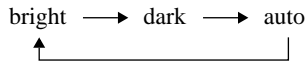

- If “auto” is selected, the display dims during disc playback. If you pause the disc or operate the unit, the display brightens temporarily.

Changing the time indicator

You can select a time indicator style for Super Audio CD playback.

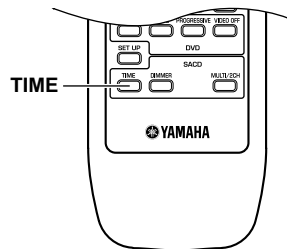

Press TIME during playback.

Press TIME to change the time indicator as follows:

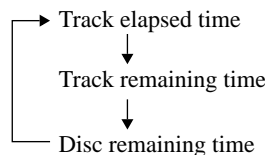

Note

- The unit does not display a disc’s remaining time during program play or random play.

TROUBLESHOOTING

Refer to the chart below if the unit does not function properly. If the problem is not listed below, or if the instructions fail to help, turn off the power to the unit, disconnect the power cable, and contact the nearest authorized YAMAHA dealer or service center.

■ General

Problem	Cause	Remedy	Refer to page
No response when buttons pressed.	Some operations may be prohibited by the disc.		—
Playback does not start, or stops immediately.	There is moisture on the laser pickup.	Wait one to two hours after switching the unit on before trying to play a disc.	—
	The disc has been loaded upside down.	Reload the disc with the label side facing up.	—
	The disc is dirty.	Clean the disc.	36
	Some discs are not compatible.		—
Audio or video is not played or is abnormal.	Connections or settings are incorrect.	Check the connections and input/output settings.	8, 9, 24–32
“No Play” appears on the unit’s display.	This unit is unable to play the loaded disc.		—
The unit does not recognize disc (“No disc” appears on the display, or the display indicates that no disc is loaded).	The disc is not loaded or placed properly.	Place the disc properly.	—

■ DVD mode

Problem	Cause	Remedy	Refer to page
No subtitles	The disc does not include subtitles.		—
	Subtitles are turned off.	Display subtitles by pressing SUBTITLE or using the on-screen menu.	15
	Subtitles might not be displayed near repeat play points A or B, or near bookmarks.		—
Alternative languages cannot be selected.	An alternative language cannot be selected on discs that do not contain more than one language.		—
	On certain discs, the user cannot select an alternative language using AUDIO or SUBTITLE. In this case, try to select an alternative language from the disc menu, if available.		—
Angle cannot be changed.	The disc or the scene being played does not support multiple angles.		—
No sound Distorted sound	If the “D.MIX” indicator on the front panel turns off during multi-channel DVD-Audio disc playback, sound will be output only from speakers specified by the disc.		—
Sound “skips.”	The disc is dirty.	Clean the disc.	36
Uncomfortable high-pitch noise	The Audio setting is inappropriate for the connected component.	Change the Audio setting in Setup menu to suit the connected digital component.	26
Picture distorted during Search	Some distortion is normal during Search.		—

Problem	Cause	Remedy	Refer to page
No picture	(U.S.A. model) If you play a PAL system DVD-Audio, the message "This disc is PAL system. The output is sound only" may appear on the monitor. No picture is available because the disc uses an incompatible type of video signal.		—
Video cannot be recorded.	Most DVD-Audio/Video discs are copy-protected and cannot be recorded.		—
Picture appears incorrectly.	Incorrect "TV aspect" setting on the Video menu (in Setup).	Select the correct setting. Note that it may be difficult to adjust the widescreen format of many DVD-Videos to fit perfectly on a 4:3 video monitor.	25
	(U.S.A. model) If you play PAL system DVD-Audio, the message "This disc is PAL system. The output is sound only." may appear on the monitor. No picture is available because the disc uses an incompatible video signal system (only audio can be played).		—
	(U.S.A. model) Due to the editing method or material used on a DVD, ghosting may occur with progressive output.	Turn off the PROGRESSIVE output.	13
(U.S.A. model) Part of the picture doubles during progressive output.	The video is in poor material condition or was edited or processed inappropriately. (Video will be played correctly via interlace output.)	Turn off the PROGRESSIVE output to output interlaced video signals to a video monitor.	13
No on-screen display		In the Setup menu, under Display, set On-Screen Messages to On.	25
On-screen menu icons not displayed or only partially displayed on the television		Press the cursor buttons [Δ, ∇] while the right-most icon is highlighted to change the menu bar position.	20
Excessive ghosting		Use the on-screen menu icons to adjust the picture quality.	23

■ SACD mode

Problem	Cause	Remedy	Refer to page
The Setup menu settings are not effective.	Setup menu settings are not effective in SACD mode.	Set the parameters for SACD mode, instead of using the Setup menu. Some parameters may not be available.	31, 32
No digital signal is output from the digital output jack.	Digital signals cannot be output from a Super Audio CD.		—

■ Remote control

Problem	Cause	Remedy	Refer to page
The remote control does not function properly.	The remote control was operated at an angle or distance in excess of its operating range.	The remote control will function within a maximum range of 6 m (20 feet) and no more than 30 degrees off-axis from the front panel.	3
	Direct sunlight or lighting (from an inverter type of fluorescent lamp, etc.) is striking the remote control sensor of the unit.	Reposition the unit.	—
	The batteries are weak.	Replace all batteries with new ones.	3

GLOSSARY

Bitstream

In this manual, “bitstream” refers to the digital form of multiple channel audio data (e.g., 5.1 channel audio) before it is decoded into its various channels.

CINEMA DSP

The Dolby Surround and DTS systems were originally designed for use in movie theaters, and theaters remain the premiere listening experience—especially movie theaters with complex speaker and sound systems, optimized for acoustics and special effects.

There is a great variety in the sound quality of listening environments in homes, due to variables such as room size, wall material, number of speakers, etc.

A result of extensive research, YAMAHA CINEMA DSP utilizes YAMAHA original sound field technology to combine three systems—Dolby Pro Logic, Dolby Digital and DTS—to create a theater-quality visual and audio experience in your home.

Decoder

A device or program that translates (decodes) encoded data on DVDs into an appropriate format.

Dolby Digital

A method for coding digital signals developed by Dolby Laboratories. In addition to stereo (2-channel) audio, Dolby Digital signals can also be 5.1-channel audio. A large amount of audio information can be recorded on one disc using this method.

Dolby Pro Logic

A surround system in which a 4-channel audio track is recorded as two channels, then restored to four channels for playback. The surround channel is monaural and can reproduce up to 7 kHz.

Dolby Pro Logic II

Dolby Pro Logic II is an improved technique for decoding data that was encoded by Dolby Surround software. This new technology enables discrete 5-channel playback with 2 front channels, 1 center channel, and 2 rear channels (instead of only 1 rear channel as with conventional Pro Logic technology). A music mode is also available for 2-channel sources in addition to the movie mode.

Frames

Moving pictures are composed of a sequence of still images called frames. About 30 frames are shown each second (30fps). Each frame is composed of two interlaced fields. A television displays these fields in rapid succession to create frames.

Frame stills and field stills

A *frame still* is an image composed of two alternating fields. Edges may be slightly blurry, but the overall image quality is high.

A *field still* is an image composed from only one of the two fields. The picture is not blurry, but contains only half of the visual information of a frame still.

Group DVD-A

A DVD audio disc is divided into large sections called “groups” and smaller sections called “tracks.” The numbers allocated to these sections are called “group numbers” and “track numbers.”

Interlaced and progressive output

NTSC, the video signal standard, uses 525 interlaced (i) scan lines. Progressive scanning uses twice that number of scan lines and is called 525p. The 525i video signals output from the unit’s COMPONENT VIDEO OUT jacks (Y, P_B, P_R) allow you to enjoy higher quality pictures than if the signals were output from the video output jack or S VIDEO OUT jack. The COMPONENT VIDEO OUT jacks are also able to handle 525p (progressive) video signals, which are of even greater resolution.

LFE 0.1 channel

This channel reproduces low bass signals in the frequency range of 20 Hz to 120 Hz. This channel is counted as 0.1 because it generates only a low frequency range relative to the full-range reproduced by the other five channels in a Dolby Digital or DTS 5.1 system.

PCM

Pulse Code Modulation (PCM) converts analog waves into digital signals. It is commonly used in the creation of music CDs. DVDs allow greater volume, and hence use linear PCM, which has a higher sampling rate. Compressed PCM signals are called packed PCM (PPCM).

Matrix 6.1

The unit incorporates a Matrix 6.1 decoder for Dolby Digital and DTS multi-channel software that enables 6.1-channel reproduction by adding a rear center channel to an existing 5.1-channel format. (The rear center channel is created from rear left and right channels, and output from a virtual rear center speaker.) With this additional channel, you can experience more dynamic and realistic moving sounds, especially in scenes with “fly-over” and “fly-around” effects.

Pan&Scan/Letterbox

In general, DVD-Video discs are produced with the intention of being viewed on a widescreen television with an aspect ratio of 16:9. This means you can view most material at the intended aspect ratio on a widescreen television. Material with this ratio will not fit onto a standard television with an aspect ratio of 4:3. Two picture styles, “Pan&Scan” and “Letterbox,” resolve this issue.

Pan&Scan: The sides of the image are trimmed so the picture can fill the screen.

Letterbox: Black bands appear across the top and bottom of the image. The picture appears at an aspect ratio of 16:9.

Playback control (PBC)

The term “playback control” on a Video CD or its packaging indicates that certain scenes or information may be viewed interactively or navigated by menu. This unit can play Video CDs that feature playback control.

Sampling frequency and quantized bits

When digitizing an analog audio signal, the number of times the signal is sampled per second constitutes the sampling frequency. The degree of fineness with which a sound level is converted into a numeric value is determined by the number of quantized bits.

SILENT CINEMA

YAMAHA has developed a natural, realistic sound effect DSP algorithm for headphones.

Parameters for headphones have been set for each sound field so that you can enjoy accurate representations of all sound fields.

Title/Chapter DVD-V

DVD-Video discs are divided into large sections (titles), and smaller sections (chapters). The numbers allocated to these sections are referred to as title numbers and chapter numbers.

Track SACD DVD-A VCD CD

A track is the smallest division on DVD-Audio, CD, and Video CD discs. It usually equates to a single song.

Virtual CINEMA DSP

YAMAHA has developed a virtual CINEMA DSP algorithm that allows you to enjoy DSP sound field surround effects without center or rear speakers—by using “virtual rear speakers.”

NOTES ON HANDLING DISCS

- Hold discs by touching only the edges or center hole.

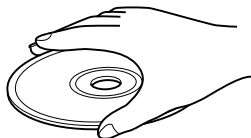

- Do not leave a disc in the tray (if you do not plan to play it).
- Do not write anything on discs using a pencil or other sharp writing tool.
- Do not use disc surface protectors (e.g., damage-resistant film).
- Store discs in an appropriate case.
- Do not use any disc that has had its surface printed by a commercially-available label printer.
- Do not expose discs to direct sunlight, high temperature or high humidity for a long period of time because these environments might warp or otherwise damage the disc.

- Playback of discs is generally not affected by small particles of dust or fingerprints on their playing surface. Even so, discs should be kept clean. Wipe discs using a clean, dry cloth. Do not wipe discs in a circular motion; wipe straight outward from the center.

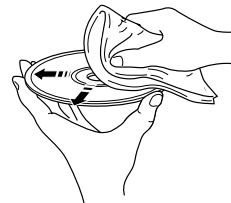

- Do not clean the disc's surface using any type of disc cleaner, record spray, anti-static spray or liquid, or any other chemical-based liquid, because such substances might irreparably damage the disc's surface.

SPECIFICATIONS

AUDIO SECTION

- Frequency Response
 - DVD Audio (192 kHz sampling)..... 2 Hz to 88 kHz
 - DVD (96 kHz sampling)..... 2 Hz to 44 kHz
 - DVD (48 kHz sampling)..... 2 Hz to 22 kHz
 - CD, Video CD..... 2 Hz to 20 kHz
- Harmonic Distortion (1 kHz)
 - SACD.....0.0016%
 - DVD (48 kHz, 24 bit).....0.002%
 - CD.....0.0022%
- S/N Ratio 115 dB (Weighted)
- Dynamic Range
 - SACD..... 108 dB
 - DVD (48 kHz, 24 bit)..... 103 dB
 - CD, Video CD..... 99 db
- Output Level (1 kHz, 0 dB)..... 2±0.3 V

VIDEO SECTION

- Video Signal Level
 - Video.....1 Vp-p/75Ω
 - S Video (Y/C)
[U.S.A. model]
.....1 Vp-p/0.286 Vp-p/75 Ω
[Australian, U.K. and European models]
.....1 Vp-p/0.3 Vp-p/75 Ω
 - Component (Y, P_B, P_R)
[U.S.A and Australian models]
.....1 Vp-p/0.7 Vp-p/75Ω
 - AV (RGB SCART)
[U.K. and European models]
.....1 Vp-p/0.7 Vp-p/75 Ω

GENERAL

- Power Supply
 - [U.S.A. model]..... AC 120 V/60 Hz
 - [Australian model]..... AC 240 V/50 Hz
 - [U.K. and European models]..... AC 230 V/50 Hz
- Power Consumption 34 W
- Laser Pickup:
 - Wave length.....665 nm
 - Laser power.....CLASS II
 - Laser output MAX. 1.0 mW (Continuous)
 - Output value determined by 21 CFR CHAPTER 1,
SUB CHAPTER J
- Dimensions (W × H × D)
..... 435 × 116 × 350 mm (17-1/8" × 4-9/16" × 13-3/4")
- Weight 8.7kg (19.2 lbs.)
- Usable temperature range5°C to 35°C
- Usable humidity range
..... 5% to 90% (There should be no condensation.)



YAMAHA ELECTRONICS CORPORATION, USA 6660 ORANGETHORPE AVE., BUENA PARK, CALIF. 90620, U.S.A.
YAMAHA CANADA MUSIC LTD. 135 MILNER AVE., SCARBOROUGH, ONTARIO M1S 3R1, CANADA
YAMAHA ELECTRONIK EUROPA G.m.b.H. SIEMENSSTR. 22-34, 25462 RELINGEN BEI HAMBURG, F.R. OF GERMANY
YAMAHA ELECTRONIQUE FRANCE S.A. RUE AMBROISE CROIZAT BP70 CROISSY-BEAUBOURG 77312 MARNE-LA-VALLEE CEDEX02, FRANCE
YAMAHA ELECTRONICS (UK) LTD. YAMAHA HOUSE, 200 RICKMANSWORTH ROAD WATFORD, HERTS WD1 7JS, ENGLAND
YAMAHA SCANDINAVIA A.B. J A WETTERGRENS GATA 1, BOX 30053, 400 43 VÄSTRA FRÖLUNDA, SWEDEN
YAMAHA MUSIC AUSTRALIA PTY, LTD. 17-33 MARKET ST., SOUTH MELBOURNE, 3205 VIC., AUSTRALIA

YAMAHA CORPORATION
Printed in Japan **UP** VIDEO WA14980