

YAMAHA

AM/FM STEREO RECEIVER

CR-220

OWNER'S MANUAL

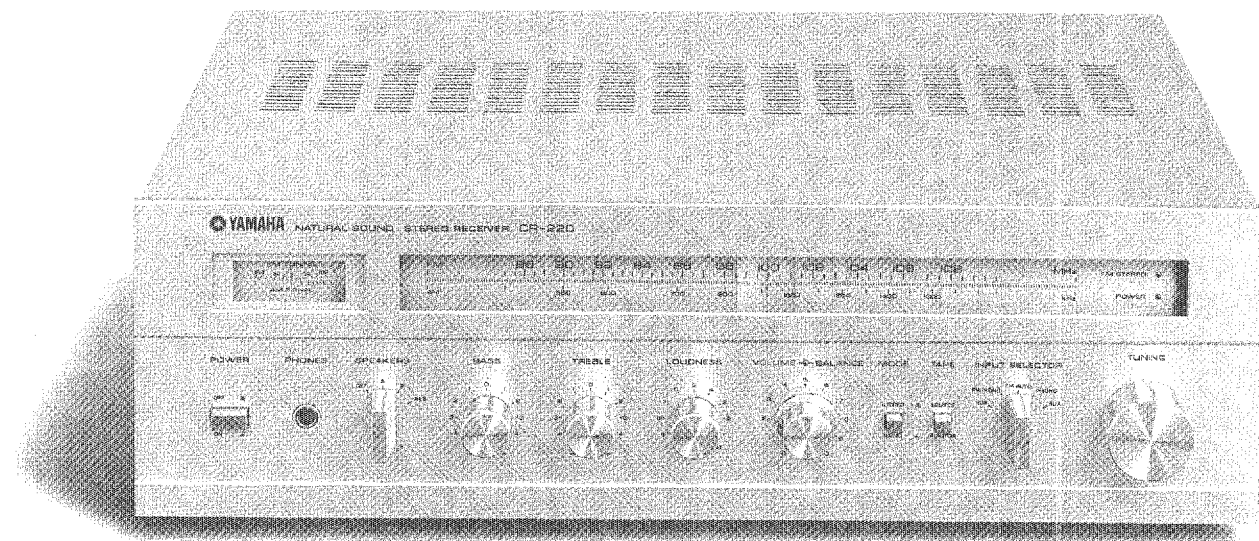

CENTER

U/C

CR-220

CONTENTS

YAMAHA offers you thanks and congratulations on your choice of the CR-220 Receiver. Embodying novel and useful features, it combines superb broadcast reception with the finest audio quality, and is currently setting new standards for receiver performance in its class.

SPECIAL FEATURES OF THE CR-220 RECEIVER

1. All-in-One Excellence

Accurately matched performance specifications, functions, and controls, give overall performance which fully measures up to Yamaha's high standards for separate tuners, pre- and power amps.

2. Noise-Distortion Clearance Range

The CR-220 offers an extremely wide range of output powers for which both noise and distortion are below the rated value, for the widest possible dynamic range in actual use. This was the basic design concept for the audio section.

3. Direct Assessment of Differential Gain

This sophisticated technique enables Yamaha to combine high station-getting ability, razor-sharp tuning, and ultra-low distortion in the tuner section.

4. Outstanding Receiver Cost/Performance

Yamaha's high-efficiency design policy, based upon high level circuit technology, has allowed us to build in superb performance in relation to the CR-220's cost.

5. Continuous Loudness Compensation

Whatever your normal maximum listening level, this Yamaha 'special' provides full compensation for the ears' reduced sensitivity to bass and treble frequencies at lower listening levels.

6. AM Antenna Circuit with Combination Signal Input System

The combination signal input system is employed for the AM antenna circuit and as it can be used as a common antenna for both FM and AM, bar antenna is unnecessary. Thus, problems of AM sensitivity change resulting from the tuner installation direction have been eliminated.

Caution — Read This Before Operating	
Your CR-220	3
Front Panel and Controls	4
Rear Panel and Connections	6
Connection Diagram	8
Broadcast Reception	9
Listening to Records, LOUDNESS, and TONE Controls	11
Tape Playback and Recording	12
Performance Graphs	13
Block Diagram	14
Schematic Diagram	15
Specifications	16
Trouble Shooting	18

IMPORTANT!

Please record the serial number of your unit in the space below

Model Name CR-220

Serial No. _____

The serial number is located on the rear of the chassis.

Retain this Owner's Manual in a safe place for future reference.

CR-220

CAUTION — READ THIS BEFORE OPERATING YOUR CR-220

1

The CR-220 is a high performance AM/FM stereo receiver, with excellent selectivity, sensitivity, and low distortion. This manual is required reading if you are to get the best from its special features and controls.

2

Do not drop or otherwise jar the CR-220, which is a precision electronic instrument.

3

Do not place the CR-220 where it will be exposed to direct sunlight, excessive heat (for instance over a radiator), cold, moisture, or dust.

4

Do not use chemical solvents (such as benzene or alcohol) to remove traces of dirt. Wipe only with a soft, slightly damp cloth.

5

Do not attempt to carry out internal adjustments or repairs. Leave these to your local authorized service representative.

6

Do not assume your CR-220 is faulty before checking 'Trouble Shooting' list provided on pages 18~19.

7

Operate all switches and knobs in accordance with the instructions. Avoid applying undue force, which should never be necessary, and do not attempt to use intermediate settings.

8

Do not connect other audio equipment to the spare AC outlet sockets on the rear panel if it will require more power than the outlets are rated to provide.

9

Keep this manual in a safe place for future reference, and refer to it frequently until you are completely familiar with all CR-220 controls and functions.

Warning — to prevent fire or shock hazard, do not expose this appliance to rain or moisture.

CR-220

FRONT PANEL AND CONTROLS

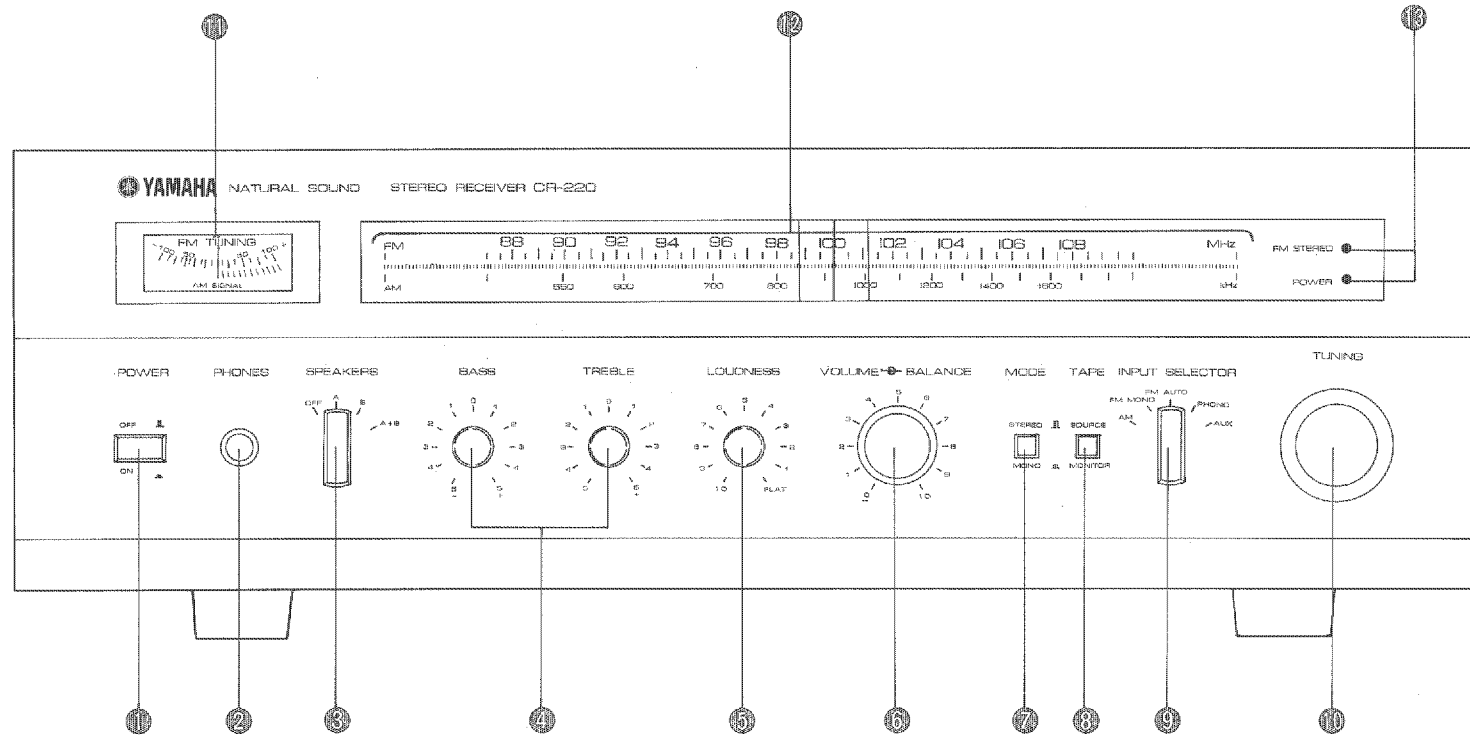

❶ POWER ON/OFF Switch

Leave the power switch OFF while familiarizing yourself with the various controls, and while you are connecting other audio equipment. Always set the VOLUME control to the '0' position when pushing this switch to ON/OFF.

❷ PHONES Jack

One headphone jack is provided. Plugging the headphone in does not mute the speakers, so use the OFF position on the SPEAKERS switch.

❸ SPEAKERS Switch

With this control, you can select either or both of

two pairs of stereo speakers, or switch them all off so that you can enjoy headphone listening.

❹ BASS and TREBLE Controls

The bass and treble controls have a low turnover frequency of 350 Hz and a high turnover frequency of 3.5 kHz respectively.

⑥ LOUDNESS Control

This boosts the extreme low and high frequencies to compensate for our ears' reduced sensitivity to these frequencies at low volumes. Set it to the FLAT position while the VOLUME control is set to your highest normal listening level. Turning the control counterclockwise will reduce the volume but will retain the natural balance between low and high frequencies.

⑥ VOLUME and BALANCE Controls

Use the VOLUME control to adjust the speaker output to obtain the volume of sound that you require. Always start operation with the VOLUME control turned fully to the left (counterclockwise) at the '0' position before turning it up to the volume level you require.

The BALANCE knob controls the difference in output volume between the L and R (left and right) stereo channels. Set this control to the center '5' position, at which there is a click stop, unless you need to correct for a lack of balance between the audio output of the two channels, or to correct for a listening position which is not equidistant from the two speakers. The BALANCE control reduces the volume from the left-hand speaker when turned clockwise, and reduces that from the right-hand speaker when turned counterclockwise.

⑦ MODE Switch

This gives the choice of stereo or monaural reproduction. Note that in the MONO position the amplifier section will reproduce all sources (including FM stereo programs, etc.) monaurally. However, even in the STEREO mode, FM stereo programs will be reproduced monaurally if the INPUT SELECTOR switch is set to FM MONO.

⑧ TAPE Monitor Switch

Depress this switch when playing back from a tape deck connected to the rear panel TAPE PB terminals. When a 3-head tape deck is used, the recording condition can be monitored.

⑨ INPUT SELECTOR Switch

Turn this knob to select the desired program source.

AM AM reception.

FM MONO When receiving monaural FM broadcasts, or in case the signal is weak or the reception conditions on FM Stereo are poor, turn the knob to FM MONO.

FM AUTO For FM Stereo reception.

PHONO This position input circuit is designed to operate with normal moving magnet (MM) type cartridges.

⑩ TUNING Control

This large tuning knob gives smooth and positive station selection, with the precision flywheel mechanism preventing backlash. Also, the tuning circuits utilize a wide air-gap high precision three-gang variable capacitor, providing great sensitivity and high stability.

⑪ FM TUNING/AM SIGNAL Meter

This meter fulfills two functions. When the INPUT SELECTOR switch is set to FM AUTO or FM MONO, it functions as an FM tuning meter, and when the switch is set to AM, as an AM signal meter.

⑫ FM/AM Tuning Scale

The upper scale gives FM station frequencies in MHz and the lower scale gives AM frequencies in kHz.

⑬ LED Indicators

The upper LED lights when an FM stereo broadcast is received, and the lower LED lights when POWER switch is on.

CR-220

REAR PANEL AND CONNECTIONS

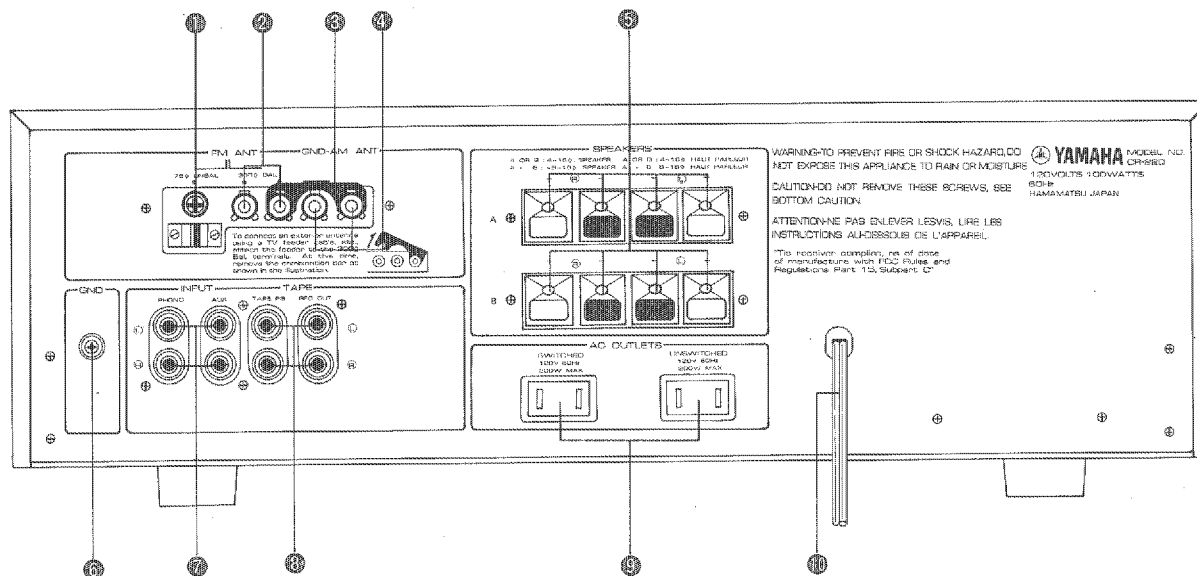

① FM ANT Terminal (75Ω Coaxial Cable)

This special bracket and terminal is provided for use with 75Ω coaxial cable. Coaxial cable, in which the central core is shielded by an outer braided sheath, reduces losses in signal strength between the antenna and the CR-220, and also reduces the amount of interference picked up.

② FM ANT Terminal (300Ω Balanced Feeder)

This is the pair of terminals used with ordinary

twin type feeder wire, like that used in the indoor FM antenna provided with the CR-220. Although the high sensitivity of the CR-220 means that an indoor antenna can often give satisfactory results with local stations, a proper FM antenna will always give better results.

④ Connecting-Bar

This bar is used for AM reception.

③ GND (Ground) and External AM ANT Terminals

By connecting the left-hand terminal to a ground cable, a significant improvement can be made to AM reception, effectively increasing sensitivity and reducing interference, particularly hum.

The FM antenna can be used as an AM antenna. A special antenna need not be set up for AM, because the combination signal input system is used as an AM whip antenna. In weak signal areas and poor reception conditions, an external antenna should be set up and connected to the right-hand terminal.

6 SPEAKERS Terminals

The CR-220 can handle two sets of speakers (A or B), with selection of either, both, or neither, by use of the SPEAKERS switch on the front panel. Speakers should have impedances between 4 and 16 ohms, but with two speaker sets being used at the same time, connect only speakers with impedances between 8 ohms and 16 ohms. Use speakers rated to take the full 15 Watts of output power, or set the VOLUME control so that the rated maximum speaker input power is not exceeded. Volume level should be reduced immediately if there is increased distortion or a sense of strain which indicates that the speakers are being overloaded.

Making the Speaker Connections

1. Strip the insulation from the speaker cable for 1/2" (10 mm), and twist stray ends together. If

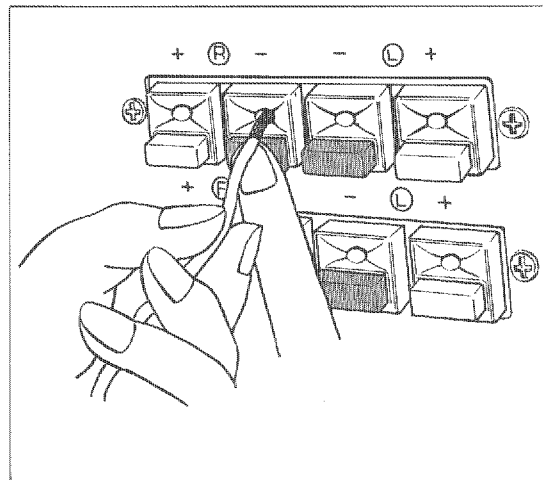

possible, solder the ends. Push the button beneath the terminal as shown in the illustration, and align the inner and outer terminal holes. Then insert the wire fully home. Release the button, and the wire end will be firmly clamped.

2. Use the upper (A) terminals first. Be careful that the terminals identified by the + and - signs above them are connected with the corresponding + and - terminals on the speakers. A mistake will result in poor bass response and ill-defined stereo image. Also be sure to connect the left-hand speaker to the L speaker terminals, and the right-hand to the R terminals.
3. Repeat this with the (B) terminals if other speakers are to be connected. In all cases make sure that connections are fully and firmly made, or you may not be able to get any sound from one or more speakers.

6 GND(Ground) Terminal

This ground terminal is provided for the grounding of turntable units, etc. Please make sure that all such units are firmly grounded: failure to connect the ground leads can result in unpleasant hum.

7 INPUT Terminals

These are the terminals which are selected by the INPUT SELECTOR switch on the front panel. They include PHONO and AUX connections. The AUX terminals can be used to connect an external tuner, or for 8-track cartridge tape playback, etc.

8 TAPE PB and REC OUT Terminals

A tape deck can be attached to these input and output terminals. Any source connected to the CR-220 can be recorded on this deck by setting the INPUT SELECTOR switch on the front panel to the appropriate position. When playing back from a tape deck, depress the front panel TAPE monitor switch.

9 AC OUTLETS

These spare AC OUTLETS are provided for your convenience in connecting other items of audio equipment. Only the left-hand outlet is controlled by the CR-220 POWER switch. This has a maximum power rating of 200 Watts, and should be used for items such as turntable units. Do not connect any item which draws more than 200 Watts. The right-hand outlet is not affected by the CR-220 POWER switch, and any items connected to them must be switched on and off with their own switches in the normal way. Note that the total power available is only 200 Watts. Use them, for say, your tape deck or decks.

10 AC Power Line

Plug the CR-220 power cord into a main power supply wall outlet socket, and make sure the line is not likely to be tripped over.

CR-220

CONNECTION DIAGRAM

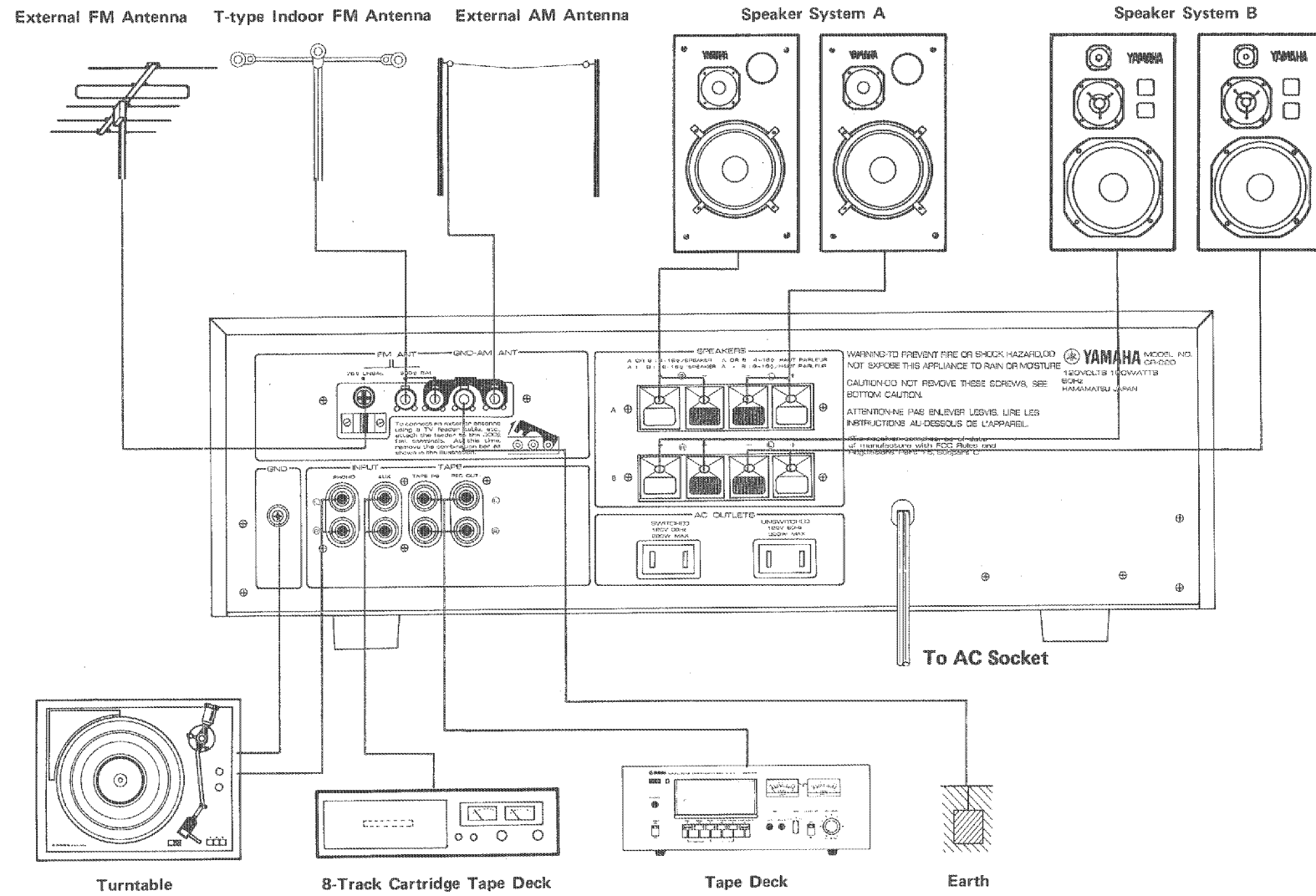

CR-220

BROADCAST RECEPTION

CONNECTING AN FM ANTENNA

The T-type antenna provided with your CR-220 is adequate only in high signal strength areas and under favorable conditions. In other cases, an external multi-element FM antenna is needed. If you cannot obtain satisfactory reception with the T-type antenna, this is an indication that you need an external FM antenna.

The external antenna should preferably be located fairly close to the CR-220, and mounted as high as conveniently possible. Try various antenna orientations, either pointing towards the weakest station you intend to receive or away from the major source of interference (preferably both, although some compromise is usually necessary in most locations).

If the antenna is intended for use with shielded coaxial cable (which reduces losses and interference), use the 75Ω UNBAL terminals on the rear panel of the CR-220, and connect the cable as shown in the illustration.

The 300 Ω BAL terminals on the rear panel (which use feeder wire similar to that of the internal antenna provided) can also be used with coaxial cable if a matching transformer is attached to the antenna. The use of coaxial cable is advisable where the antenna must be located some distance from the CR-220, or where interference from automobile ignition, etc., is troublesome.

CONNECTING COAXIAL CABLE

1. Strip the insulation from outside the braided sheath, and bend back the metal braiding *outside* the insulation. Expose the projecting central core wire as shown. Be careful not to cut through any strands.
2. Slacken the two retaining screws as shown and insert the coaxial cable.
3. Re-tighten the screws so that the clip grips the exposed braided sheath.
4. Connect the central core wire to the 75 Ω terminal.
5. Ensure that the braiding does not come into contact with the inner core.

AM RECEPTION CONNECTING-BAR INSTALLATION

If the FM antenna is used for an AM whip antenna, install the connecting-bar, as in the right-hand figure.

If the FM antenna coaxial cable is equipped with a matching transformer, this connecting-bar is unnecessary.

FM Antenna Connections

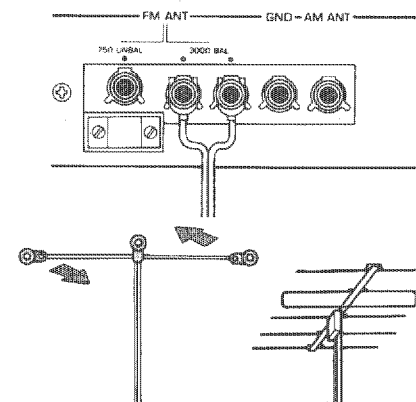

Coaxial Cable Connections

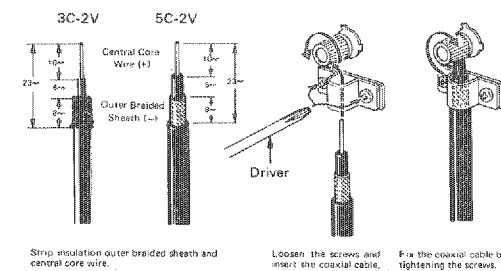

Connecting-Bar Installations

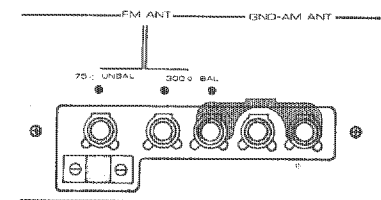

FM TUNING Meter

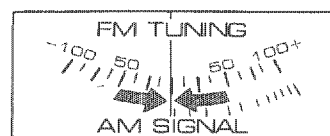

AM SIGNAL Meter

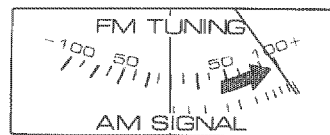

External AM Antenna Connection

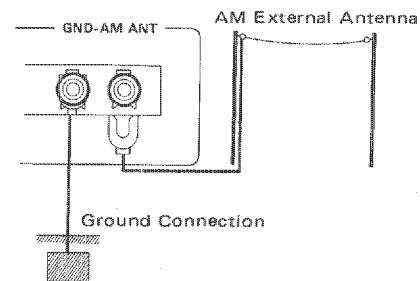

FM BROADCAST RECEPTION

1. Set the INPUT SELECTOR to FM AUTO.
2. Set the Tuning Indicator to the frequency (MHz) of the station you want to listen to. Precise tuning is accomplished by watching the FM tuning meter, and centering the needle exactly in the middle.
3. Now tune to bring the FM TUNING meter pointer to the exact center. This is the optimum tuning position: set it carefully.
4. Check that the FM STEREO indicating LED on the right-hand side of the dial lights if you intend listening to a stereo rather than a monaural broadcast.

Note: If the FM broadcast is monaural or the reception condition is poor and is affected by static noise, try setting the INPUT SELECTOR switch to FM MONO.

FM AUTO/FM MUTING ON

In the recommended FM AUTO position, the weakest stations will be cut out (muted), together with the inter-station noise. You will be able to tune from station to station, free of background noise and remote, very poor quality stations. This muting circuit is adjusted to eliminate all signal inputs to the CR-220 which are below a threshold value of $5\mu V$.

CONNECTING AN EXTERNAL AM ANTENNA

In a metal-frame building, or in locations remote from the station or where reception conditions are unfavorable, an external AM antenna should be connected to the AM ANT terminal. Even better results will be obtained if at the same time a good ground (earth) connection is made. A good ground connection can sometimes be made to a water pipe. However, under NO circumstances should you attempt to make a ground connection to a gas pipe. Your dealer will advise you.

AM RECEPTION

- 1 Set the INPUT SELECTOR switch on the front panel to AM.
- 2 Turn the tuning knob until the tuning indicator is at the station's frequency.
- 3 Adjust the tuning knob to give the maximum reading on the AM SIGNAL meter.

CR-220

LISTENING TO RECORDS, LOUDNESS AND TONE CONTROLS

CONNECTING A TURNTABLE UNIT

The main AC supply plug of your turntable unit may usually be conveniently inserted into the spare AC outlet socket controlled by the CR-220 POWER switch. With some turntables it is important not to disconnect the main supply without first switching off at the turntable itself (*read the turntable instruction manual to check*).

The pin plugs on the output lead from the turntable unit should be connected to the PHONO terminal pin jacks at the left-hand side of the rear panel. Check that the L and R pin plugs (for the left and right channels) have been correctly inserted. Do not forget to connect the turntable ground line to the GND terminal on the CR-220 rear panel.

Switch on the receiver POWER switch, and set the INPUT SELECTOR switch to PHONO. The PHONO input circuit is intended for use with standard moving magnet (MM), moving iron (MI) or induced magnet (IM) type cartridges. Certain moving coil (MC) cartridges can also be used, but some have output levels too low for satisfactory performance without the use of a step-up transformer or head amplifier. Note that the PHONO input pin-plugs should never be connected or disconnected while the POWER switch is ON.

Always switch off your speakers by releasing the SPEAKERS switch when raising or lowering the cartridge stylus over the record to prevent overloading and possible damage.

If you play monaural records, the signal-to-noise

ratio will be improved if you push the MODE to the MONO position.

Use the BASS and TREBLE controls to give the best tonal balance, and use the LOUDNESS volume control rather than the main volume control to reduce listening levels below your normal maximum.

CONTINUOUS LOUDNESS CONTROL

Set this to the *FLAT* position (not the mid-point '5') when listening at normal high levels. The LOUDNESS compensation curves shown enable the same subjective tonal balance to be retained as this control is turned down, unlike the VOLUME control itself, for listening at lower levels.

COMPREHENSIVE TONE CONTROLS

The carefully chosen turnover frequencies of the bass and treble tone controls have optimum influence at the higher and lower frequencies for major correction of tonal character.

SUBSONIC FILTER

A subsonic filter which is built in the CR-220 cancels the extremely low frequency range below 15 Hz at 12 dB/octave, thus eliminating noises which may be harmful to speakers.

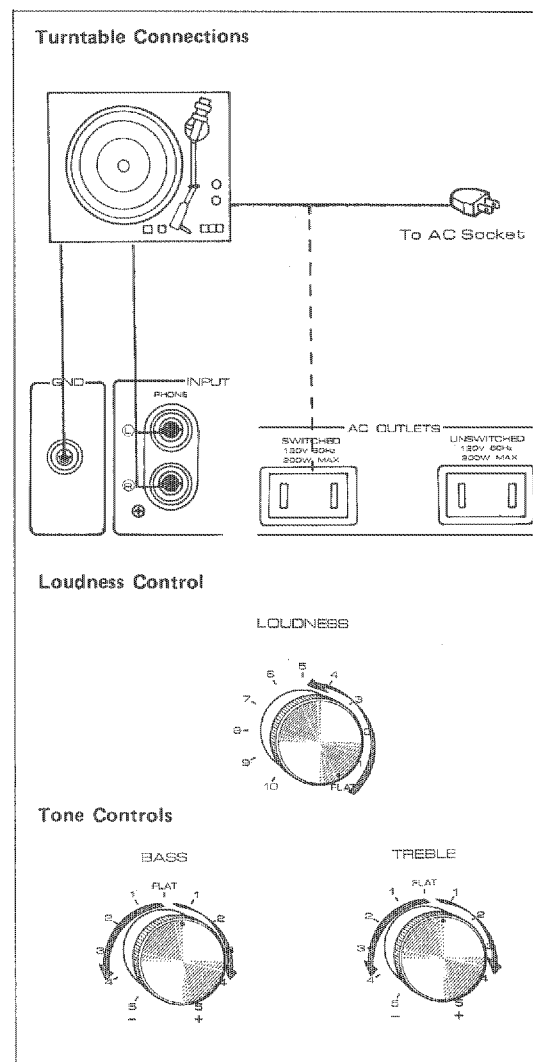

CR-220

TAPE PLAYBACK AND RECORDING

TAPE DECK CONNECTION

Connect a tape recorder to the CR-220 as follows:

CR-220 Rear Panel	Tape deck Terminals
TAPE PB	LINE OUT
REC OUT	LINE IN

TAPE DECK PLAYBACK

Push the TAPE monitor switch on the front panel to MONITOR. Use the output level controls on the tape deck or decks to adjust the playback level so that there is no great change in volume level when switching between FM AUTO and TAPE terminals.

TAPE DECK RECORDING

When you wish to make a recording, set the front panel INPUT SELECTOR switch to the desired program source.

The level at which a tape recording is made is very important: for full details of recording techniques you should consult the instruction manual provided with your tape deck. Adjustments in level must be made with the input level controls on the tape deck. Note that the signals from the REC OUT terminals which are recorded by your tape deck are not influenced at all by settings of the tone and volume controls, etc., on the front panel of the CR-220, and all such tonal and other adjustments must be made on playback. If you record at too low a level you will notice a high level of tape 'hiss' on playback, and if the level is too high, the peak volume levels will be distorted and you may even have difficulty in erasing them later.

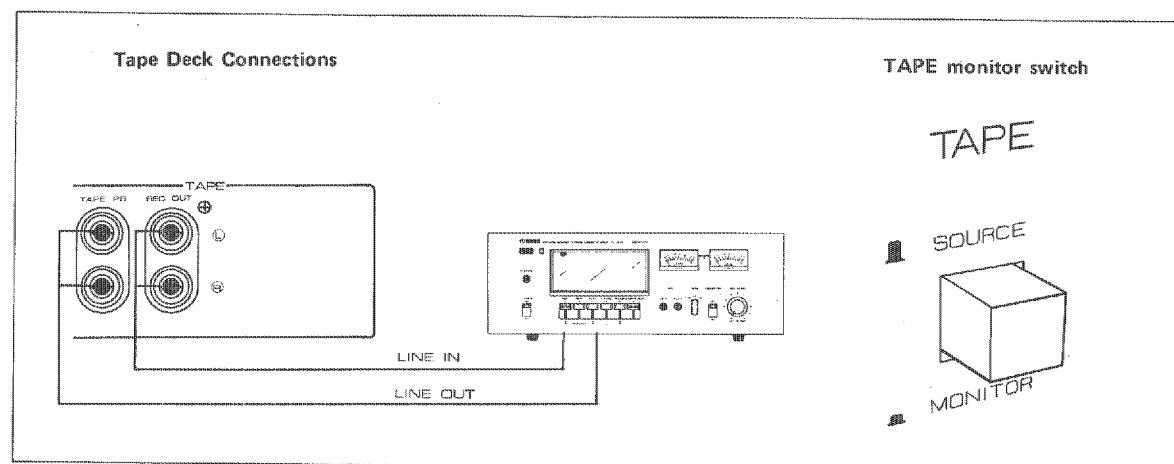

CR-220

PERFORMANCE GRAPHS

Output Power vs. Total Harmonic Distortion

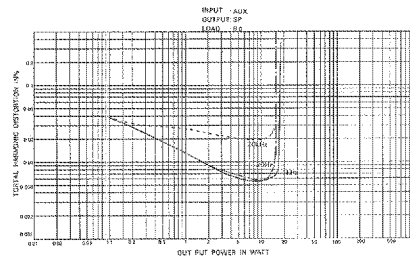

Continuous Loudness Control Contours

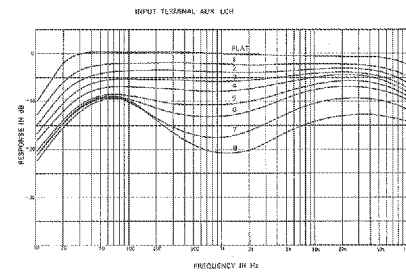

Stereo Separation vs. Modulation Frequency

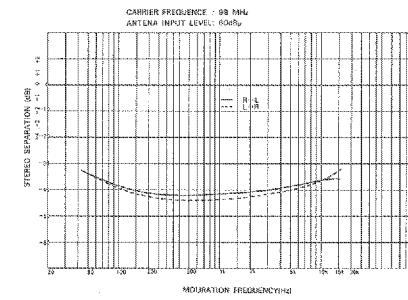

RIAA Deviation

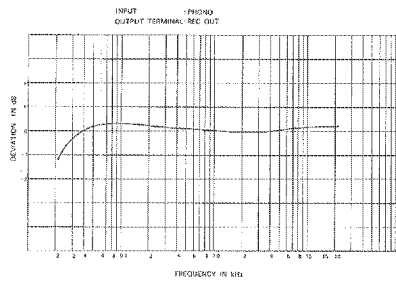

Frequency Response

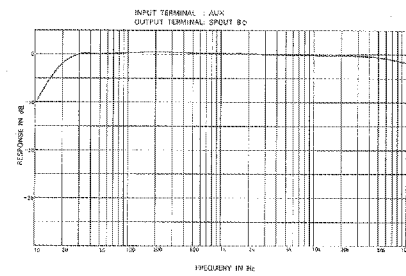

Modulation Frequency vs. Distortion

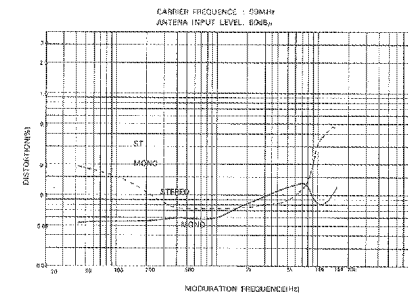

Tone Control Characteristics

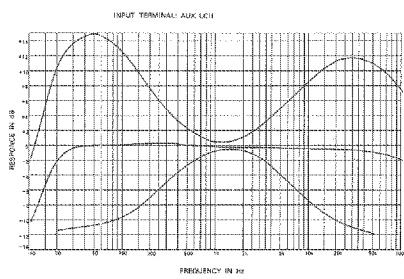

Output/Noise Level vs. Antenna Input Level

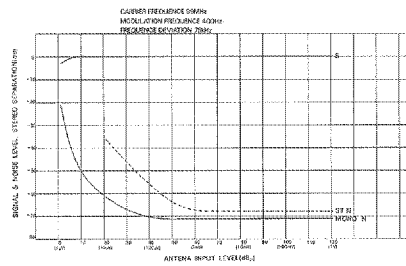

CR-220

BLOCK DIAGRAM

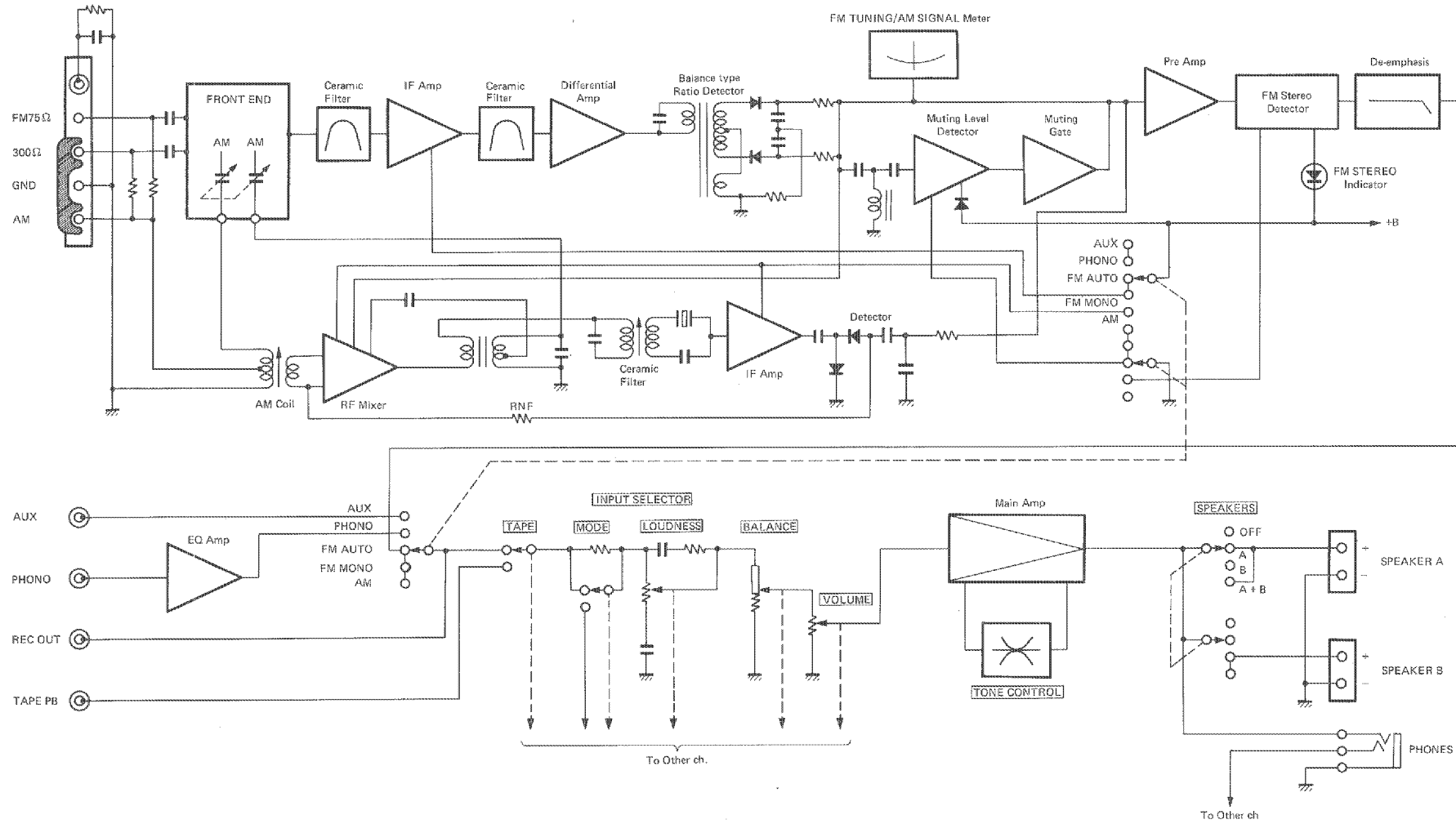

CR-220

SCHEMATIC DIAGRAM

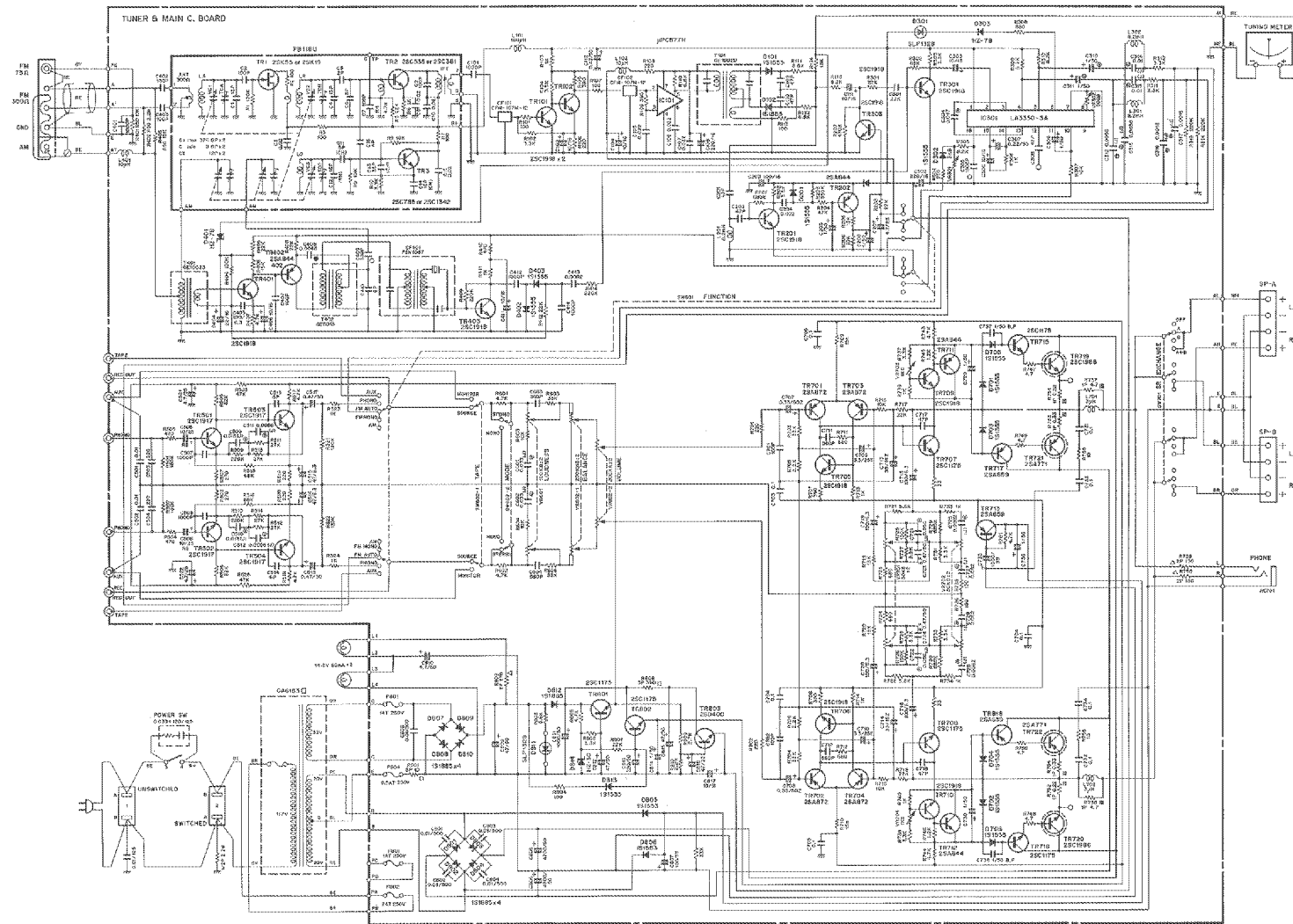

CR-220

SPECIFICATIONS

AUDIO SECTION		
Output Power (0.05% T·H·D)		
Continuous R·M·S Power (both channels driven, Aux → Sp Out)		
20 ~ 20,000 Hz	15W (8Ω)	
1kHz	17W (8Ω)	
1kHz	20W (4Ω)	
Total Harmonic Distortion (20 ~ 20,000Hz, 8Ω)		
Aux → Sp Out	0.25W ~ 15W	0.05%
	7.5W	0.025%
Input Sensitivity Impedance (1kHz)		
Aux	120mV/47kΩ	
Phono	2mV/47kΩ	
Maximum Input Levels (0.05% T·H·D, 1kHz)		
Phono	110mV	
Output Level/Impedance (1kHz)		
Phono → Rec Out	120mV/1kΩ	
Frequency Response		
Phono RIAA Deviation		
(Phono → Rec Out)	±0.5dB	
Aux → Sp Out	20~20,000Hz	±0.5, -2.0dB
Tone & Loudness Controls Characteristics		
Bass Turnover Frequency	350Hz	
Bass Boost/Cut	+14, -10dB at 50Hz	
Treble Turnover Frequency	3.5kHz	
Treble Boost/Cut	+12, -10dB at 20kHz	
Loudness Control	Level-related equalizer	

Signal-to-Noise Ratio (IHF-A Network)	
Phono	90dB/for 10mV shorted
Aux	96dB
Residual noise	0.14mV
Power Bandwidth (0.05% T·H·D)	10 ~ 40,000Hz
Damping Factor (1kHz, 8Ω)	40
FM SECTION	
Tuning Range	88 ~ 108MHz
Usable Sensitivity (IHF)	
300Ω	11.2dBf/2.0μV
75Ω	11.2dBf/1.0μV
50dB Quieting Sensitivity	
Mono	17.3dBf/4μV
Stereo	38.3dBf/50μV
Image Response Ratio (98MHz)	50dB
IF Response Ratio (98MHz)	75dB
Spurious Response Ratio (98MHz)	75dB
AM Suppression Ratio (IHF)	52dB
Capture Ratio	1.5dB
Alternate Channel Selectivity (IHF)	60dB ±400kHz,
Signal-to-Noise Ratio (IHF, 65dBf)	
Mono	70dB
Stereo	65dB

Distortion (at 65dBf)		
Mono	100Hz	0.2%
	1kHz	0.2%
	6kHz	0.4%
Stereo	100Hz	0.3%
	1kHz	0.3%
	6kHz	0.8%
Intermodulation Distortion (IHF)		
Mono		0.2%
Stereo		0.4%
Subcarrier Product Ratio		40dB
Stereo Separation		
50Hz		30dB
1kHz		40dB
10kHz		30dB
Frequency Response		
50 ~ 10,000Hz		±0.5dB
30 ~ 15,000Hz		+1, -3dB
Muting Threshold		19.2dBf/5μV
Output Level/Impedance		
Rec Out		400mV/6kΩ
AM SECTION		
Tuning Range		525 ~ 1,605kHz
Usable Sensitivity (IHF)		18μV/mV
Usable Selectivity		20dB

Signal-to-Noise Ratio (80dB/m: antenna input)		
		50dB
Image Response Ratio (1,000kHz)		40dB
Spurious Response Ratio (1,000kHz)		40dB
Total Harmonic Distortion (80dB/m: antenna input)		
		0.6%
Output Level/Impedance (80dB/m: antenna input, 30% modulation)		
		100mV/6kΩ
GENERAL		
Semiconductors	Transistors	39
	FET	1
	ICs	2
	Diodes	28
	LEDs	2
Power Supplies	120V AC 60Hz	
Power Consumption	100W	
Dimensions (WxHxD)	435 x 144 x 326.5 (mm)	
	(17-1/8" x 5-11/16" x 12-7/8")	
Weight	7.6 kg (16 lbs 12oz)	

CR-220

TROUBLE SHOOTING

Before assuming that your CR-220 is faulty, check this trouble-shooting list. It details many steps you can take yourself without having to call a service representative.

AUDIO SECTION

Fault	Cause	Cure
No power although POWER switch is ON (POWER LED unlit).	AC power line not plugged-in to supply socket. AC main fuse has blown.	Plug firmly into the supply socket. Contact your service representative for a replacement.
No sound although power is connected.	Volume too low. INPUT SELECTOR in wrong position. Input pin plugs incorrectly inserted, loose, or disconnected. Speaker connections faulty. Speaker switch is set in wrong position. In modes other than tape playback, the TAPE MONITOR switch is kept in depressed position.	Turn up volume. Check and change as necessary. Check and insert fully in the correct positions. Check and correct. Correct setting. Depress tape monitor switch once more for SOURCE.
Sound comes only, or mainly, from either L or R speaker.	Speaker connections faulty. Input connections faulty. BALANCE control not properly adjusted.	Check and correct. Check and correct. Set to give correct stereo balance.
Sound suddenly ceases during audition.	The protective circuit has been activated. AC main fuse has blown.	Check for incorrect (too low) speaker impedances or short circuits and correct. If the fault persists, switch off and wait briefly before switching on again. Contact your service representative for a replacement.
Poor bass response and badly defined stereo image.	Speaker + and - connections are incorrect.	Reverse the connections to one speaker, not both.
A loud 'hum' is heard with or instead of, the record when attempting PHONO audition.	Either the pin-plugs from the phono cartridge are not firmly plugged into the input sockets, or the braided shielding wire is defective.	Plug in firmly, replacing the defective shielding if necessary. Check and correct the GND (ground) wire connection.
The volume control cannot be raised during record audition without a loud 'booming' noise.	This is caused by feedback of sound from the speakers to the phono cartridge stylus, and is called 'howling.'	Increase the separation between turntable unit and speakers, avoiding locations directly in line with the speakers.
Bass and treble frequencies are unnaturally exaggerated.	The LOUDNESS volume control is set too low.	Turn to the FLAT position (fully clockwise) and reset main and LOUDNESS volume controls according to the instructions.

TUNER SECTION

Fault	Cure	Cause
A persistent hum occurs when an AM station is tuned.	This modulation hum can affect whole areas where conditions are unfavorable.	Sometimes changing the position of the CR-220 will give an improvement.
Intermittent crackling or continuous background 'roaring' on AM.	Atmospheric electricity or electrical storms, possibly fluorescent lighting or other electrical equipment.	Difficult to eliminate, an external antenna and good ground connection will give considerable improvement.
High pitched whistles, etc., particularly at night on AM.	The CR-220 is being operated too near a TV set.	Increase the separation between the TV and the CR-220
A stereo station is heard monaurally.	The amplifier MODE switch is set to MONO.	Push and release to the STEREO position.
Occasional crackling interference (particularly with remote, weak signal stations).	Electrical noise from automobiles, etc., or from other electrical equipment.	Set up an external FM antenna as high and as far from the road as convenient: use coaxial cable. Fit an interference suppressor to the offending item where possible.
Disturbing levels of 'hiss' noise when on FM stereo stations.	FM stereo broadcasts are inherently more liable to incur this at remote, low signal strength locations.	Set up an external FM antenna; if you are already using one, orient it towards the station or replace with a more sensitive array.
Local stations suffer from unclear, distorted sound.	Signal input from the antenna for these stations is too strong.	Connect an attenuator between the FM antenna and the CR-220, or turn the antenna away from the strongest (closest) station.
During stereo test transmissions, sounds which should come from only one channel can be heard faintly over the other.	This is known as crosstalk, and normally occurs to some extent.	Provided the sound level is very faint compared with the normal level for that channel, no fault is indicated.

SINCE 1887  **YAMAHA**
NIPPON GAKKI CO., LTD., HAMAMATSU, JAPAN