



A R T I S T E

***AR-100***

OWNER'S MANUAL

**YAMAHA**

# SPECIAL MESSAGE SECTION

**PRODUCT SAFETY MARKINGS:** Yamaha electronic products may have either labels similar to the graphics shown below or molded / stamped facsimiles of these graphics on the enclosure. The explanation of these graphics appears on this page. Please observe all cautions indicated on this page and those indicated in the safety instruction section.

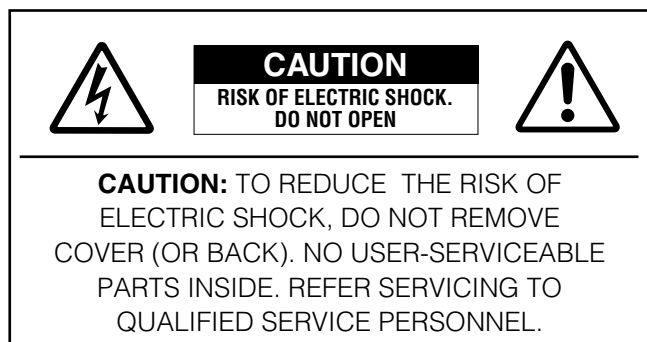

See the name plate for graphic symbol markings.



The exclamation point within the equilateral triangle is intended to alert the user to the present of important operating and maintenance (servicing) instructions in the literature accompanying the product.

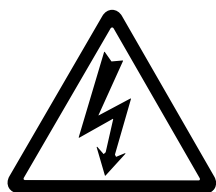

The lightning flash with arrowhead symbol within the equilateral triangle is intended to alert the user to the presence of uninsulated "dangerous voltage" within the product's enclosure that may be of sufficient magnitude to constitute a risk of electrical shock.

**IMPORTANT NOTICE:** All Yamaha electronic products are tested and approved by an independent safety testing laboratory in order that you may be sure that when it is properly installed and used in its normal and customary manner, all foreseeable risks have been eliminated. DO NOT modify this unit or commission others to do so unless specifically authorized by Yamaha. Product performance and/or safety standards may be diminished. Claims filed under the expressed warranty may be denied if the unit is/has been modified. Implied warranties may also be affected.

**SPECIFICATIONS SUBJECT TO CHANGE:** The information contained in this manual is believed to be correct at the time of printing. However, Yamaha reserves the right to change or modify any of the specifications without notice or obligation to update existing units.

**ENVIRONMENTAL ISSUES:** Yamaha strives to produce products that are both user safe and environmentally friendly. We sincerely believe that our products and the production methods used to produce them, meet these goals. In keeping with both the letter and the spirit of the law, we want you to be aware of the following:

**Battery Notice:** This product MAY contain a small nonrechargeable battery which (if applicable) is soldered in place. The average life span of this type of battery is approximately five years. When replacement becomes necessary, contact a qualified service representative to perform the replacement.

**Warning:** Do not attempt to recharge, disassemble, or incinerate this type of battery. Keep all batteries away from children. Dispose of used batteries promptly and as regulated by applicable laws. Note: In some areas, the servicer is required by law to return the defective parts. However, you do have the option of having the servicer dispose of these parts for you.

**Disposal Notice:** Should this product become damaged beyond repair, or for some reason its useful life is considered to be at an end, please observe all local, state, and federal regulations that relate to the disposal of products that contain lead, batteries, plastics, etc.

**NOTICE:** Service charges incurred due to lack of knowledge relating to how a function or effect works (when the unit is operating as designed) are not covered by the manufacturer's warranty, and are therefore the owner's responsibility. Please study this manual carefully and consult your dealer before requesting service.

**NAME PLATE LOCATION:** The graphic below indicates the location of the name plate. The model number, serial number, power requirements, etc., are located on this plate. You should record the model number, serial number, and the date of purchase in the spaces provided below and retain this manual as a permanent record of your purchase.

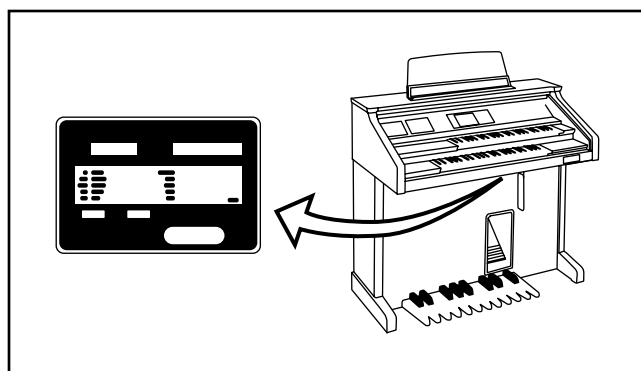

Model \_\_\_\_\_

Serial No. \_\_\_\_\_

Purchase Date \_\_\_\_\_

# IMPORTANT SAFETY INSTRUCTIONS

INFORMATION RELATING TO PERSONAL INJURY, ELECTRICAL SHOCK, AND FIRE HAZARD  
POSSIBILITIES HAS BEEN INCLUDED IN THIS LIST.

**WARNING-** When using any electrical or electronic product, basic precautions should always be followed. These precautions include, but are not limited to, the following:

**1.** Read all Safety Instructions, Installation Instructions, Special Message Section items, and any Assembly Instructions found in this manual BEFORE making any connections, including connections to the main supply.

**2.** Main Power Supply Verification: Yamaha products are manufactured specifically for the supply voltage in the area where they are to be sold. If you should move, or if any doubt exists about the supply voltage in your area, please contact your dealer for supply voltage verification and (if applicable) instructions. The required supply voltage is printed on the name plate. For name plate location, please refer to the graphic found in the Special Message Section of this manual.

**3.** This product may be equipped with a polarized plug (one blade wider than the other ). If you are unable to insert the plug into the outlet, turn the plug over and try again. If the problem persists, contact an electrician to have the obsolete outlet replaced. DO NOT defeat the safety purpose of the plug.

**4.** Some electronic products utilize external power supplies or adapters. DO NOT connect this type of product to any power supply or adapter other than one described in the owners manual, on the name plate, or specifically recommended by Yamaha.

**5. WARNING:** Do not place this product or any other objects on the power cord or place it in a position where anyone could walk on, trip over, or roll anything over power or connecting cords of any kind. The use of an extension cord is not recommended! IF you must use an extension cord, the minimum wire size for a 25' cord (or less) is 18 AWG. NOTE: The smaller the AWG number, the larger the current handling capacity. For longer extension cords, consult a local electrician.

**6.** Ventilation: Electronic products, unless specifically designed for enclosed installations, should be placed in locations that do not interfere with proper ventilation. If instructions for enclosed installations are not provided, it must be assumed that unobstructed ventilation is required.

**7.** Temperature considerations: Electronic products should be installed in locations that do not significantly contribute to their operating temperature. Placement of this product close to heat sources such as; radiators, heat registers and other devices that produce heat should be avoided.

**8.** This product was NOT designed for use in wet/damp locations and should not be used near water or exposed to rain. Examples of wet /damp locations are; near a swimming pool, spa, tub, sink, or wet basement.

**9.** This product should be used only with the components supplied or; a cart ,rack, or stand that is recommended by the manufacturer . If a cart, rack, or stand is used, please observe all safety markings and instructions that accompany the accessory product.

**10.** The power supply cord (plug) should be disconnected from the outlet when electronic products are to be left unused for extended periods of time. Cords should also be disconnected when there is a high probability of lightening and/or electrical storm activity.

**11.** Care should be taken that objects do not fall and liquids are not spilled into the enclosure through any openings that may exist.

**12.** Electrical/electronic products should be serviced by a qualified service person when:

- a. The power supply cord has been damaged; or
- b. Objects have fallen, been inserted, or liquids have been spilled into the enclosure through openings; or
- c. The product has been exposed to rain; or
- d. The product does not operate, exhibits a marked change in performance; or
- e. The product has been dropped, or the enclosure of the product has been damaged.

**13.** Do not attempt to service this product beyond that described in the user-maintenance instructions. All other servicing should be referred to qualified service personnel.

**14.** This product, either alone or in combination with an amplifier and headphones or speaker/s, may be capable of producing sound levels that could cause permanent hearing loss. DO NOT operate for a long period of time at a high volume level or at a level that is uncomfortable. If you experience any hearing loss or ringing in the ears, you should consult an audiologist.

**IMPORTANT:** The louder the sound, the shorter the time period before damage occurs.

**15.** Some Yamaha products may have benches and/or accessory mounting fixtures that are either supplied as a part of the product or as optional accessories. Some of these items are designed to be dealer assembled or installed. Please make sure that benches are stable and any optional fixtures (where applicable) are well secured BEFORE using. Benches supplied by Yamaha are designed for seating only. No other uses are recommended.

## PLEASE KEEP THIS MANUAL

# FCC INFORMATION (U.S.A.)

## 1. IMPORTANT NOTICE: DO NOT MODIFY THIS UNIT!

This product, when installed as indicated in the instructions contained in this manual, meets FCC requirements. Modifications not expressly approved by Yamaha may void your authority, granted by the FCC, to use the product.

## 2. IMPORTANT:

When connecting this product to accessories and/or another product use only high quality shielded cables. Cable/s supplied with this product MUST be used. Follow all installation instructions. Failure to follow instructions could void your FCC authorization to use this product in the USA.

## 3. NOTE:

This product has been tested and found to comply with the requirements listed in FCC Regulations, Part 15 for Class "B" digital devices. Compliance with these requirements provides a reasonable level of assurance that your use of this product in a residential environment will not result in harmful interference with other electronic devices. This equipment generates/uses radio frequencies and, if not installed and used according to the instructions found in the users manual, may cause interference

harmful to the operation of other electronic devices. Compliance with FCC regulations does not guarantee that interference will not occur in all installations. If this product is found to be the source of interference, which can be determined by turning the unit "OFF" and "ON", please try to eliminate the problem by using one of the following measures:

Relocate either this product or the device that is being affected by the interference.

Utilize power outlets that are on different branch (circuit breaker or fuse) circuits or install AC line filter/s.

In the case of radio or TV interference, relocate/reorient the antenna. If the antenna lead-in is 300 ohm ribbon lead, change the lead-in to co-axial type cable.

If these corrective measures do not produce satisfactory results, please contact the local retailer authorized to distribute this type of product. If you can not locate the appropriate retailer, please contact Yamaha Corporation of America, Electronic Service Division, 6600 Orangethorpe Ave, Buena Park, CA90620

The above statements apply ONLY to those products distributed by Yamaha Corporation of America or its subsidiaries.

\* This applies only to products distributed by YAMAHA CORPORATION OF AMERICA.

**CAUTION:** TO PREVENT ELECTRIC SHOCK, MATCH WIDE BLADE OF PLUG TO WIDE SLOT, FULLY INSERT.

**ATTENTION:** POUR ÉVITER LES CHOCS ÉLECTRIQUES, INTRODUIRE LA LAME LA PLUS LARGE DE LA FICHE DANS LA BORNE CORRESPONDANTE DE LA PRISE ET POUSSER JUSQU'AU FOND.

• This applies only to products distributed by Yamaha Canada Music Ltd.  
• Ceci ne s'applique qu'aux produits distribués par Yamaha Canada Musique Ltée.

## IMPORTANT NOTICE FOR THE UNITED KINGDOM

### Connecting the Plug and Cord

IMPORTANT. The wires in this mains lead are coloured in accordance with the following code:

BLUE : NEUTRAL  
BROWN : LIVE

As the colours of the wires in the mains lead of this apparatus may not correspond with the coloured markings identifying the terminals in your plug proceed as follows:

The wire which is coloured BLUE must be connected to the terminal which is marked with the letter N or coloured BLACK.

The wire which is coloured BROWN must be connected to the terminal which is marked with the letter L or coloured RED.

Making sure that neither core is connected to the earth terminal of the three pin plug.

The LCD displays as illustrated in this owner's manual are for instructional purposes, and may appear somewhat different from the displays which appear on your instrument.

Die in dieser Bedienungsanleitung gezeigten Meldungen auf dem LCD (Display) dienen lediglich der Information und können sich von denen unterscheiden, die tatsächlich auf dem Display Ihres Instruments erscheinen.

• This applies only to products distributed by Yamaha-Kemble Music (U.K.) Ltd.

# PRECAUTIONS

## PLEASE READ CAREFULLY BEFORE PROCEEDING

\* Please keep these precautions in a safe place for future reference.

### **WARNING**

**Always follow the basic precautions listed below to avoid the possibility of serious injury or even death from electrical shock, short-circuiting, damages, fire or other hazards. These precautions include, but are not limited to, the following:**

- Do not open the instrument or attempt to disassemble the internal parts or modify them in any way. The instrument contains no user-serviceable parts. If it should appear to be malfunctioning, discontinue use immediately and have it inspected by qualified Yamaha service personnel.
- Do not expose the instrument to rain, use it near water or in damp or wet conditions, or place containers on it containing liquids which might spill into any openings.
- If the power cord or plug becomes frayed or damaged, or if there is a sudden loss of sound during use of the instrument, or if any unusual smells or smoke should appear to be caused by it, immediately turn off the power switch, disconnect the electric plug from the outlet, and have the instrument inspected by qualified Yamaha service personnel.
- Only use the voltage specified as correct for the instrument. The required voltage is printed on the name plate of the instrument.
- Before cleaning the instrument, always remove the electric plug from the outlet. Never insert or remove an electric plug with wet hands.
- Check the electric plug periodically and remove any dirt or dust which may have accumulated on it.

### **CAUTION**

**Always follow the basic precautions listed below to avoid the possibility of physical injury to you or others, or damage to the instrument or other property. These precautions include, but are not limited to, the following:**

- Do not place the power cord near heat sources such as heaters or radiators, and do not excessively bend or otherwise damage the cord, place heavy objects on it, or place it in a position where anyone could walk on, trip over, or roll anything over it.
  - When removing the electric plug from an outlet, always hold the plug itself and not the cord. Pulling by the cord can damage it.
  - Do not connect the instrument to an electrical outlet using a multiple-connector. Doing so can result in lower sound quality, or possibly cause overheating in the outlet.
  - Remove the electric plug from the outlet when the instrument is not to be used for extended periods of time, or during electrical storms.
  - Before connecting the instrument to other electronic components, turn off the power for all components. Before turning the power on or off for all components, set all volume levels to minimum.
  - Do not expose the instrument to excessive dust or vibrations, or extreme cold or heat (such as in direct sunlight, near a heater, or in a car during the day) to prevent the possibility of panel disfiguration or damage to the internal components.
  - Do not use the instrument near other electrical products such as televisions, radios, or speakers, since this might cause interference which can affect proper operation of the other products.
  - Do not place the instrument in an unstable position where it might accidentally fall over.
  - Before moving the instrument, remove all connected cables.
  - When cleaning the instrument, use a soft, dry cloth. Do not use paint thinners, solvents, cleaning fluids, or chemical-impregnated wiping cloths. Also, do not place vinyl or plastic objects on the instrument, since this might discolor the panel or keyboard.
  - Do not rest your weight on, or place heavy objects on the instrument, and do not use excessive force on the buttons, switches or connectors.
  - Take care that the key cover does not pinch your fingers, and do not insert a finger or hand in the key cover gap.
  - Never insert or drop paper or metallic or other objects between the slits of the key cover and the keyboard. If this happens, immediately turn off the power and remove the electric plug from the outlet and have the instrument inspected by qualified Yamaha service personnel.
  - Do not place the instrument against a wall (allow at least 3 cm/one-inch from the wall), since this can cause inadequate air circulation, and possibly result in the instrument overheating.
  - Do not operate the instrument for a long period of time at a high or uncomfortable volume level, since this can cause permanent hearing loss. If you experience any hearing loss or ringing in the ears, consult a physician.
- **USING THE BENCH**
- Do not play carelessly with or stand on the bench. Using it as a tool or step-ladder or for any other purpose might result in accident or injury.
  - Only one person should sit on the bench at a time, in order to prevent the possibility of accident or injury.
  - If the bench screws become loose due to extensive long-term use, tighten them periodically using the included tool.
- **SAVING USER DATA**
- Always save data to a floppy disk frequently, in order to help prevent the loss of important data due to a malfunction or user operating error.
- Yamaha cannot be held responsible for damage caused by improper use or modifications to the instrument, or data that is lost or destroyed.

Always turn the power off when the instrument is not in use.

# ***Congratulations and thank you for purchasing the Yamaha AR-100 Electone!***

The AR-100 combines the most advanced and natural-sounding AWM tone generation technology with state-of-the-art digital electronics and features to give you stunning sound quality with maximum musical enjoyment. A large custom display also makes the AR-100 exceptionally easy to use and operate.

In order to make the most of the Electone and its extensive potential, we urge you to read the manual thoroughly while trying out the various features described. Keep the manual in a safe place for later reference.

## ***Table of Contents***

---

Panel Controls .....	2	<b>4. Voice Controls and Effects .....</b>	<b>32</b>	Memory .....	59
Main Features .....	4	Voice Condition Pages .....	33	About the A.B.C. Modes and Memory Settings .....	60
<b>1. Introductory Guide .....</b>	<b>6</b>	Effect Set Pages .....	37	Disabling Accompaniment Changes (Disable) .....	61
Getting Started .....	6	Turning on the Effects .....	37	Keyboard Percussion .....	61
Playing the Demo Songs .....	8	Calling Up the Effect Set Pages .....	37	Preset Percussion Assignments for the Lower Keyboard .....	63
Registration Menu .....	9	TREMOLLO & SYMPHONIC Page .....	37	Preset Percussion Assignments for the Pedalboard .....	63
Using the Display and Related Controls .....	11	DELAY & FLANGER Page .....	38	User Keyboard Percussion .....	64
Help Messages .....	13	Panel-selectable Effects — Tremolo, Sustain, and Reverb .....	39	Clear .....	66
Other Controls .....	14	Tremolo .....	39	User Keyboard Percussion Categories .....	67
<b>2. Voice Sections .....</b>	<b>15</b>	Reverb .....	41	Other User Keyboard Percussion Functions .....	68
Selecting Voices .....	15	Sustain .....	43	Copying User Locations .....	69
Selecting Voices from the Dotted Buttons .....	19	Glide .....	44	Melody On Chord .....	70
Voice Menus/Voice List .....	21	<b>5. Styles (Rhythm and Accompaniment) .....</b>	<b>45</b>	L.M. Split .....	71
Voice Display .....	23	Selecting and Playing Styles .....	45	<b>6. Registration Memory .....</b>	<b>73</b>
Saving and Recalling Panel Settings .....	25	Style Condition Page .....	51	Storing Registrations .....	73
<b>3. Flute/Tibia and Extra Voice .....</b>	<b>26</b>	Selecting Styles from the Dotted Buttons .....	52	Selecting Registrations .....	74
Flute/Tibia (Theatre) .....	26	Style Menus/Style List .....	54	Saving Registration Data to Disk .....	74
Creating Flute/Tibia Voices .....	26	Automatic Accompaniment — Auto Bass Chord .....	55	Recalling Recorded Registrations (and Bulk Data) .....	75
Setting Footages .....	26	Setting the A.B.C. Mode .....	55	Registration Shift .....	76
Setting the Click and Response .....	28	Mode .....	56	Resetting the Electone to the Factory Preset (Power On Reset) .....	79
Setting Attack/Chiff .....	29	Single Finger Mode Chords .....	57	Recall Panel Function .....	80
Extra Voice .....	29	Chord Cancel .....	57	Initial Registration .....	81
		Fingered Mode Chords .....	58		

<b>7. Music Disk Recorder .....</b>	<b>83</b>
M.D.R. Precautions .....	83
Formatting a Disk .....	85
Recording .....	88
Recording Parts Separately.....	92
Recording Registrations (and Bulk Data) .....	95
Recalling Recorded Registrations (and Bulk Data) .....	96
Replacing Registrations.....	96
Naming Your Song .....	97
Playback .....	99
Song Playback .....	99
Playback of Selected Parts .....	100
Repeat Play.....	101
Playback of XG/GM Disks (optional).....	102
Playback of DOC Disks (optional).....	104
Loading Styles from Style File Disks .....	107
Other M.D.R. Functions .....	108
Custom Play.....	108
Playback Controls — Pause and Rewind/Fast Forward .....	108
Changing the Tempo.....	109
Song Copy .....	110
Song Delete .....	111
Disk Copy.....	111
Checking the Remaining Memory .....	113
Copy Protect .....	113
<b>8. Voice Edit.....</b>	<b>114</b>
Selecting a Voice for Editing/Calling Up the Voice Edit Pages .....	114
Naming Your Voice.....	118
Saving the Edited Voice .....	119
Quitting Voice Edit .....	120
Recalling an Edited Voice.....	120
Saving User Voices to Disk .....	121
Loading User Voices from Disk .....	121
<b>9. Accompaniment Program .....</b>	<b>122</b>
Calling Up the Accompaniment Program Function.....	122
Accompaniment Program Voice List .....	125
Accompaniment Program Drum List.....	126
Drum Assignment.....	128
Recording a User Style.....	129
Mute .....	134
Delete.....	135
Direct Cancel (Rhythm parts only) .....	135
Editing Recorded Parts — Copy and Quantize.....	136
Part Copy .....	137
Part Quantize .....	138

Other Settings — Volume, Reverb, Chorus, and Pan.....	139
Naming Your User Style .....	140
Saving Your User Style .....	140
Clear All Data .....	141
Quitting Accompaniment Program.....	142
Selecting and Playing User Styles.....	143
Saving User Styles to Disk .....	144
Loading User Styles from Disk .....	144
<b>10. Sequence Program .....</b>	<b>145</b>
Calling Up the Sequence Program Function ...	145
Creating a Sequence Program .....	146
Auditioning the Sequence .....	149
Copying Sequence Data.....	150
Saving the Sequence and Quitting Sequence Program .....	151
Playing Sequences.....	151
Playing All Sequences in Order.....	152
Saving Sequence Data to Disk.....	152
Loading Sequence Data from Disk.....	152
<b>11. Footswitches and Knee Lever .....</b>	<b>153</b>
Footswitches.....	153
OFF .....	153
RHYTHM.....	154
GLIDE .....	155
TREMOLLO .....	156
Knee Lever .....	156
Sustain Control.....	156
Melody On Chord Control .....	157
Lead Slide Control.....	158
<b>12. Accessory Jacks and Controls ....</b>	<b>159</b>
<b>13. Pitch Controls .....</b>	<b>160</b>
TRANSCOPE Buttons .....	161
<b>14. MIDI .....</b>	<b>162</b>
<b>15. Appendix .....</b>	<b>165</b>
Troubleshooting .....	165
MIDI Implementation Chart.....	169
Specifications .....	171
Index.....	172

<b>1</b>	<b>Introductory Guide</b>
<b>2</b>	<b>Voice Sections</b>
<b>3</b>	<b>Flute/Tibia and Extra Voice</b>
<b>4</b>	<b>Voice Controls and Effects</b>
<b>5</b>	<b>Styles (Rhythm and Accompaniment)</b>
<b>6</b>	<b>Registration Memory</b>
<b>7</b>	<b>Music Disk Recorder</b>
<b>8</b>	<b>Voice Edit</b>
<b>9</b>	<b>Accompaniment Program</b>
<b>10</b>	<b>Sequence Program</b>
<b>11</b>	<b>Footswitches and Knee Lever</b>
<b>12</b>	<b>Accessory Jacks and Controls</b>
<b>13</b>	<b>Pitch Control</b>
<b>14</b>	<b>MIDI</b>
<b>15</b>	<b>Appendix</b>

# Panel Controls

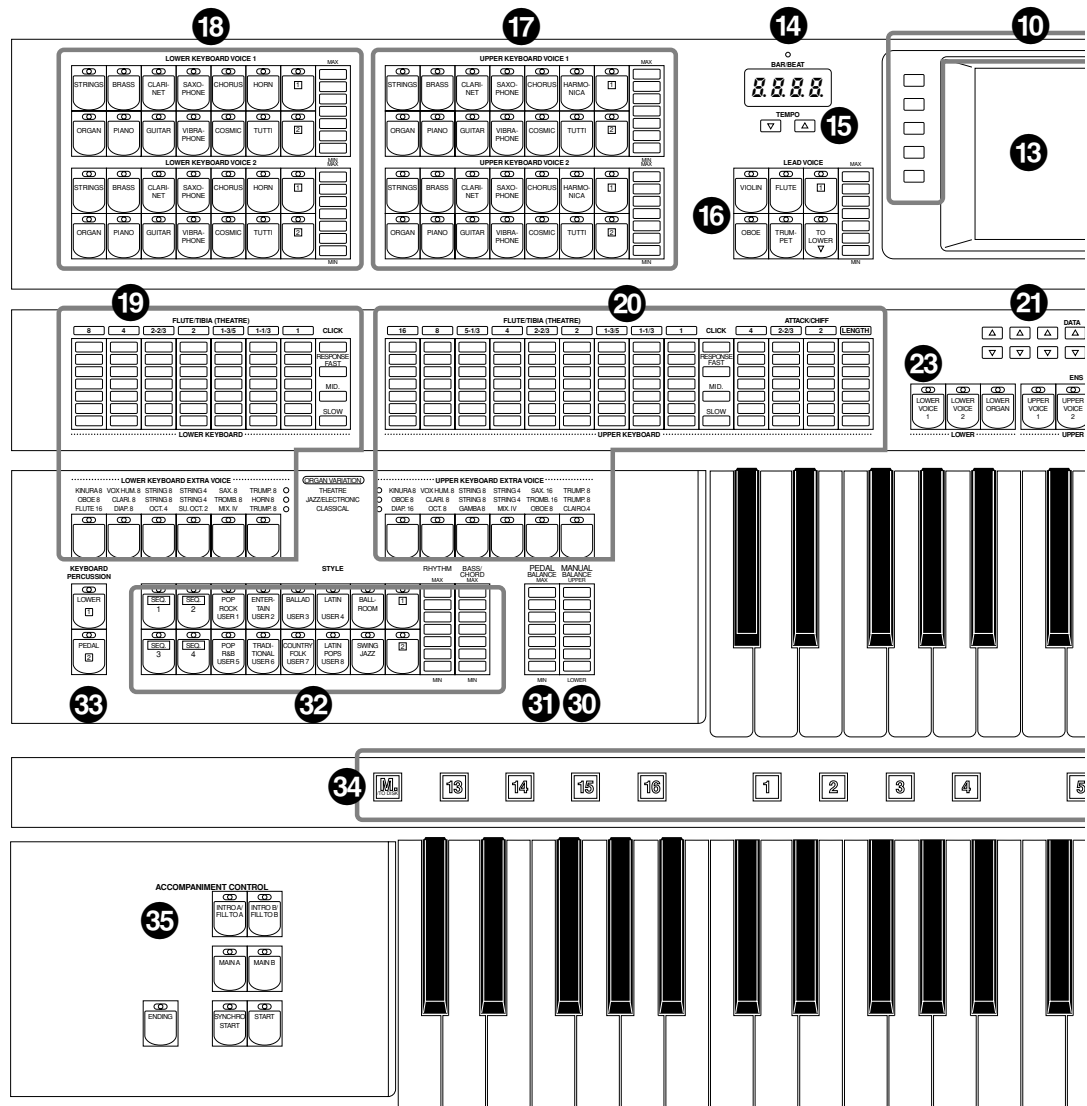

- ❶ POWER switch .....P. 6
- ❷ MASTER VOLUME.....P. 7
- ❸ CONSOLE LIGHT button .....P. 7
- ❹ DEMO button .....P. 8
- ❺ D. (Disable) button .....P. 61, 74
- ❻ AUTO BASS CHORD .....P. 55
- ❼ REGISTRATION MENU .....P. 9
- ❽ PEDAL VOICE .....P. 15
- ❾ DISPLAY SELECT buttons .....P. 11

- ❿ MENU buttons .....P. 11
- ⓫ PAGE buttons .....P. 11
- ⓬ CONTRAST dial .....P. 14
- ⓭ Liquid Crystal Display (LCD) .....P. 11
- ⓮ BAR/BEAT DISPLAY .....P. 46
- ⓯ TEMPO buttons .....P. 46
- ⓰ LEAD VOICE .....P. 15
- ⓱ UPPER KEYBOARD VOICE .....P. 15
- ⓲ LOWER KEYBOARD VOICE .....P. 15
- ⓳ FLUTE/TIBIA and EXTRA VOICE-LOWER..P. 26



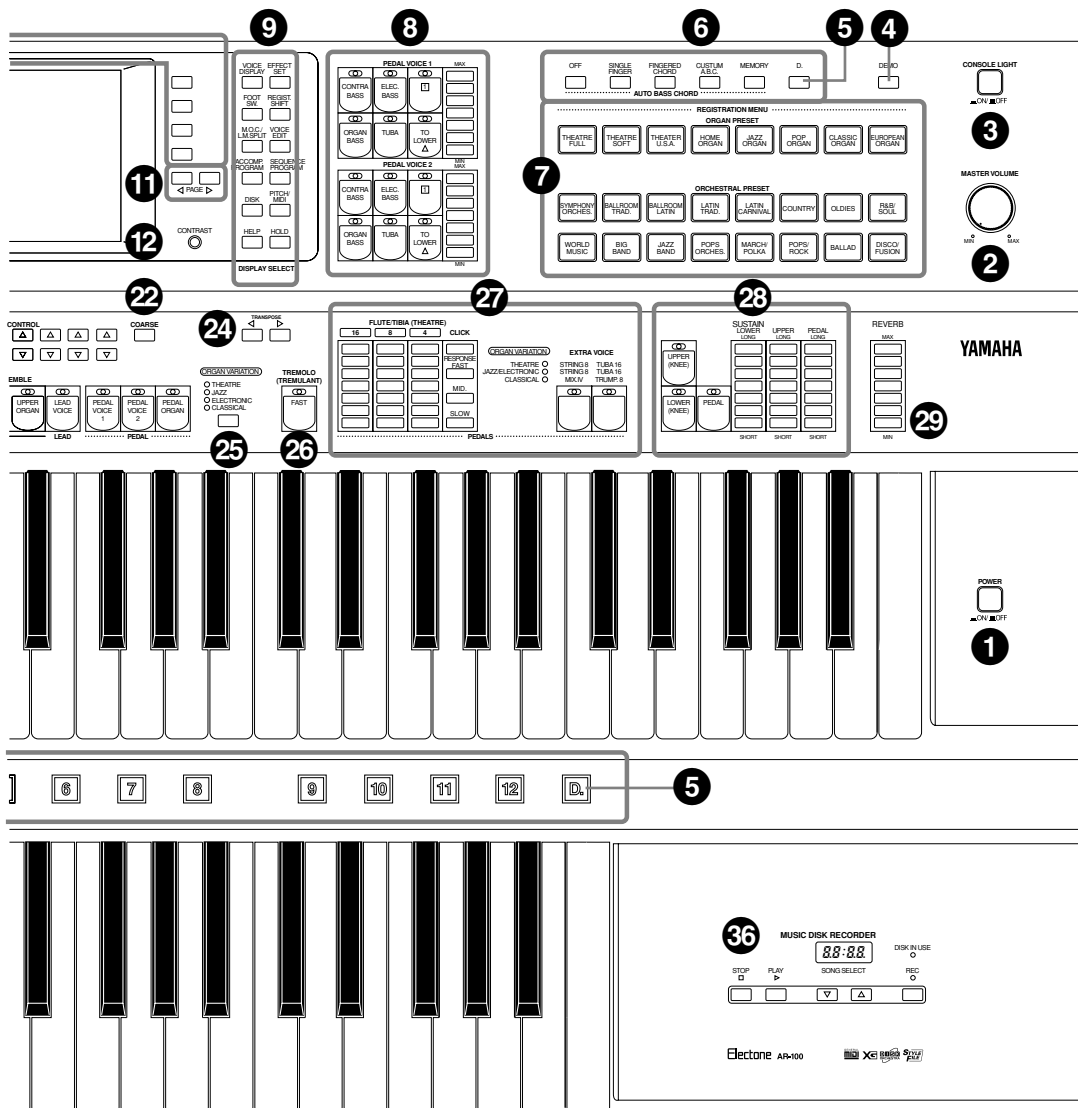

- 20 FLUTE/TIBIA and EXTRA VOICE-UPPER ..P. 26
- 21 DATA CONTROL buttons .....P. 11
- 22 COARSE button .....P. 14
- 23 ENSEMBLE buttons .....P. 15
- 24 TRANSPOSE buttons.....P. 161
- 25 ORGAN VARIATION button .....P. 27
- 26 TREMOLO button.....P. 39
- 27 FLUTE/TIBIA and EXTRA VOICE-PEDAL ..P. 26

- 28 SUSTAIN .....P. 43
- 29 REVERB.....P. 41
- 30 MANUAL BALANCE .....P. 18
- 31 PEDAL BALANCE .....P. 18
- 32 STYLE .....P. 45
- 33 KEYBOARD PERCUSSION.....P. 61
- 34 REGISTRATION MEMORY buttons ..P. 73
- 35 ACCOMPANIMENT CONTROL ..P. 47
- 36 MUSIC DISK RECORDER .....P. 83

# ***Main Features***

---

**Your Yamaha AR-100 Electone is packed with many sophisticated functions, yet is amazingly easy to use. The main features are briefly described here (along with page references) so that you can quickly understand the capabilities of the Electone.**

## **Astoundingly True-to-life Sounds**

The new AWM (Advanced Wave Memory) tone generation technology gives you 205 exceptionally realistic and natural-sounding Voices. The AR-100 also has special Voice sets for XG, GM (General MIDI) and DOC (Disk Orchestra) song data. To make sure you're never at a loss for notes, the AR-100 has an amazingly large 128-note polyphonic capacity. What's more, the touch response built into the keyboards provides full expressive control over the Voices. (See page 15.)

## **Variety of Organ Sounds**

The Flute/Tibia and Extra Voice sections (page 26) give you access to a wide variety of conventional and traditional organ sounds — from jazz and pop to church and theatre.

## **Instant Registration Changes**

The extensive Registration Menu section of the AR-100 gives you instant access to 384 different Registrations, covering a broad range of musical styles. Each Registration features complete Voice and Style (rhythm/accompaniment) settings to perfectly match the type of music. (See page 9.) Moreover, sixteen Registration Memory panel buttons let you store your own custom Registrations and call them up instantly as you perform. (See page 73.)

## **Original Voice Creation**

The Voice Edit feature provides simple, easy-to-use voice editing tools for creating your own original Electone Voices. (See page 114.)

## **Dynamic, Realistic Automatic Accompaniment**

The Style section of the AR-100 features 160 specially programmed rhythm and accompaniment patterns — in a wide variety of musical genres. (See page 45.) The A.B.C. (Auto Bass Chord) gives you full, exciting instrumental backing — just like a real band — that automatically changes bass and chords according to the chords (and pedal notes) you play. (See page 55.) Plus, the Keyboard Percussion lets you assign and play the realistic drum and percussion sounds from the keyboard. (See page 61.)

## **L.M. Split**

This special function lets you assign different Voices to assignable left and right sides of the Lower keyboard, effectively giving you a "third" keyboard. (See page 71.)

## **Accompaniment Program and Sequence Program**

The powerful Accompaniment Program function lets you create your own User Styles (accompaniment patterns) — including drum/percussion, bass, chord, pad and phrase parts. Each Style you create can have different Intro, Main A and B, Fill In, and Ending patterns. (See page 122.)

The Sequence Program function lets you connect your original User Styles together with the preset Styles to create up to four complete rhythm/accompaniment tracks, which you can automatically play back during your performance. Naturally, you can use the A.B.C. automatic accompaniment features with these Style sequences as well. (See page 145.)

## **Wide Variety of Digital Effects**

The AR-100 Voices can also be enhanced with a full range of high-quality effects, including Tremolo (for reproducing rotating speaker sounds), Symphonic/Celeste, Flanger, Delay, Reverb, and Sustain. (See page 32.)

## **Recording of Performances with the Music Disk Recorder**

The AR-100 also features a Music Disk Recorder (M.D.R.) for recording your Registrations and performances. The recording is completely digital and is stored to disk, which means you can edit it to your liking at any time, and no matter how many times you play it back, it will always sound exactly as you originally performed it. (See page 83.)

In addition to play of the included XG disk (see page 9), the M.D.R. can play a wide variety of commercially available song disks, including XG and DOC (Disk Orchestra). (See pages 102, 104.)

## **Large Custom Display**

The large LCD display (along with the dedicated buttons that surround it) provides comprehensive and easy-to-understand control over virtually all of the AR-100's operations. (See page 11.)

# Introductory Guide

Whether you are an advanced Electone performer or have never touched an electronic keyboard in your life, we recommend that you take the time to go through this basic section. It shows you in the simplest possible manner how to start playing your AR-100. It also introduces you to some of the basic operations and functions that will come in handy when you later use the AR100's more advanced features.

## Getting Started

1. Plug the power cord into an appropriate electrical outlet.

### CAUTION

Yamaha products are manufactured specifically for the supply voltage in the area where they are to be sold. If you should move, or if any doubt exists about the supply voltage, please consult with a qualified technician.

2. Turn on the Electone by pressing the POWER switch.



After a brief greeting display, the Voice Display automatically appears.

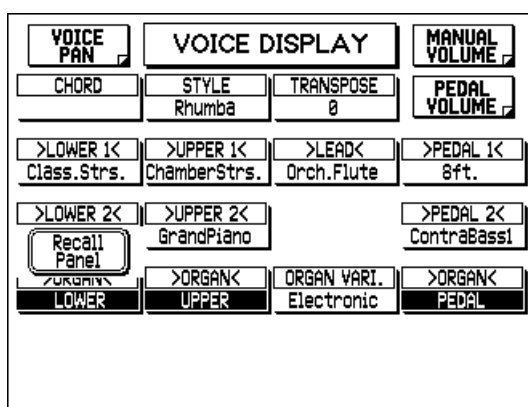

### NOTE

A "Recall Panel" Menu briefly appears at the left side of the display after you turn on the AR-100. Selecting this restores the settings last made to the Electone before it was turned off. (For more information, see page 80.)

The Voice Display shows information on many important settings for the instrument, including all Voice sections, current Style and Transpose settings, and the currently played chord in the Lower keyboard. It also provides direct access to volume and pan settings. (See page 23 for more information.)

### 3. Set the MASTER VOLUME control.

The MASTER VOLUME control is an overall control which affects the volume of the entire instrument.

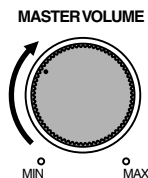

### 4. Press the Expression pedal down with your foot.

Once you have set the MASTER VOLUME control to a suitable level, you can use the Expression pedal to change the volume with your foot as you play.

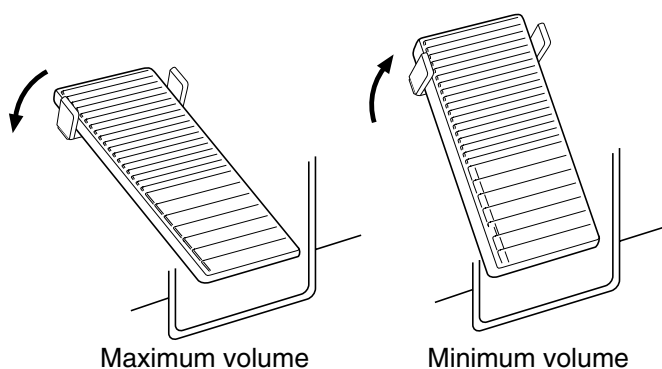

### ***About the Console Light***

*The AR-100 is equipped with a convenient console light that illuminates the panel for optimum viewing, especially in dark, live performance conditions.*

#### **To turn on the console light:**

*Press the CONSOLE LIGHT switch at the top right of the front panel.*

DEMO



CONSOLE LIGHT



ON/OFF

# Playing the Demo Songs

Before you start playing your new AR-100, you'll probably want to hear what the instrument is truly capable of doing. For this purpose, the AR-100 features a variety of special Demo Songs that showcase the dynamic Voices and Styles of the instrument. There are a total of 24 Demo Songs, each recorded in a different music style, and each corresponding to the 24 music styles of the Registration Menu.

Though the Demo Songs are a wonderful introduction to the instrument for those just starting out, we suggest you listen to the Demo Songs from time to time. No matter what your level of Electone expertise, you'll find them to be a continuing source of inspiration for ways to best use and perform on your new AR-100.

## To select and play a Demo Song or Songs:

### 1. Press the DEMO button, located at the top right of the front panel.

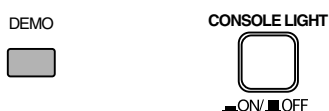

Within several seconds, the AR-100 automatically starts playing all Demo Songs in order, and the entire Demo repeats indefinitely.

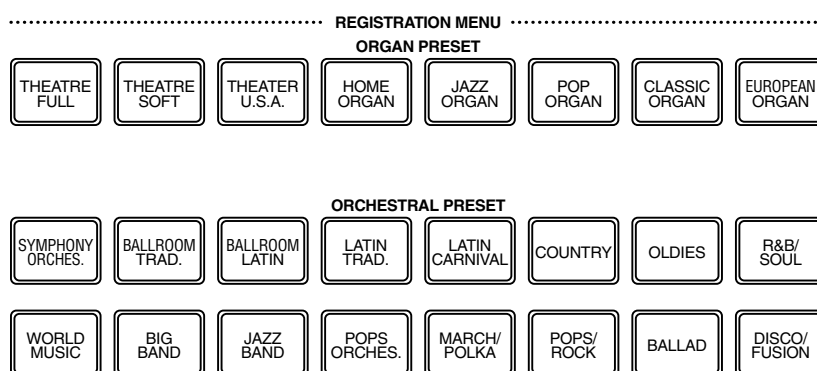

### NOTE

The Demo function cannot be used when the following functions are active:

- Accompaniment Program
- Sequence Program
- Voice Edit
- Help

Also, Demo cannot be used when there is a disk in the M.D.R. or when the XG/GM or DOC mode is selected.

You can use the Data Control buttons (below the corresponding functions in the display) to turn Repeat on/off, or change the Demo Song mode — ALL (all Songs in order), RANDOM (all Songs at random), or SINGLE (a single selected Song).

### 2. To stop Demo play back and quit the Demo function, press the DEMO button again.

Alternately, you can both stop playback and quit the Demo function simultaneously by pressing the currently lit REGISTRATION MENU button (during playback).

## Playing the Included XG Disk

Included with your AR-100 is an XG Song Disk. This disk features eight Demo Songs that have recorded in Yamaha's XG format, and demonstrate the stunning XG/GM Voices of the instrument. The AR-100 is compatible with virtually all XG and GM song data disks, of which there is a extremely wide variety.

## Registration Menu

The next place to continue your explorations of the AR-100 is the Registration Menu. This section features a total of 384 preset Registrations, created to suit a wide variety of music styles. You've already heard some of these Registrations in action when you listened to the special Demo Songs. Since each Registration has all appropriate settings for the selected type of music — including suitable Voices and Styles — you can instantly change all panel settings with the touch of a single button. The Registrations are divided into two types: Organ Presets and Orchestral Presets.

To use the Registration Menu presets:

1. Press the button in the REGISTRATION MENU section corresponding to the desired style.

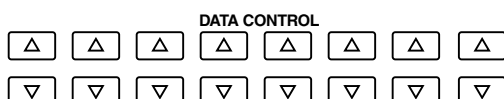
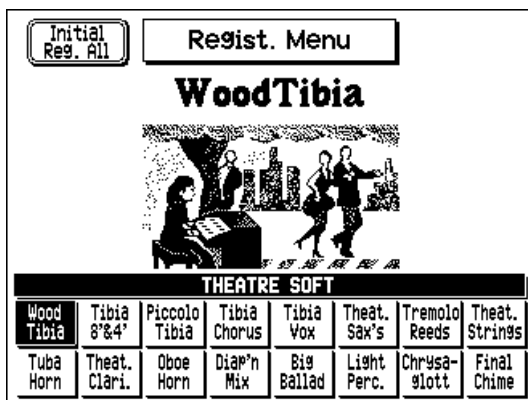
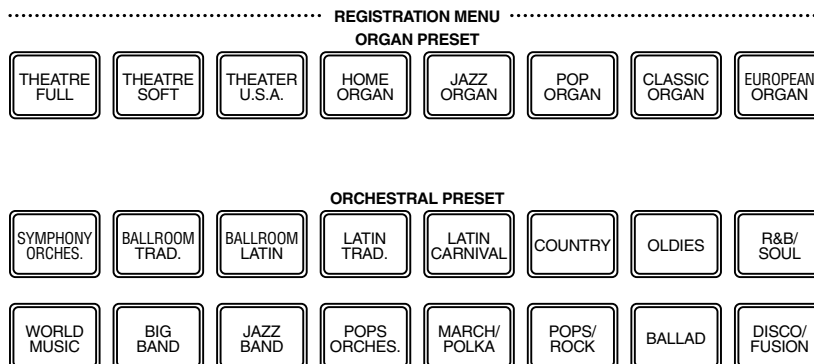

### NOTE

For information on the menu shown at the left of the display ("Initial Reg. All" when an ORGAN PRESET button is pressed; "Initial Regist (1-16)" when an ORCHESTRAL PRESET button is pressed), see pages 81 and 82.

## 2. Select the desired Registration from the display with the appropriate Data Control button.

Each Registration Menu button selection calls up a menu of up to 16 Registrations. Press the Data Control button that corresponds to the Registration you wish to play.

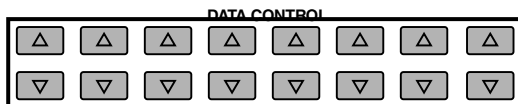
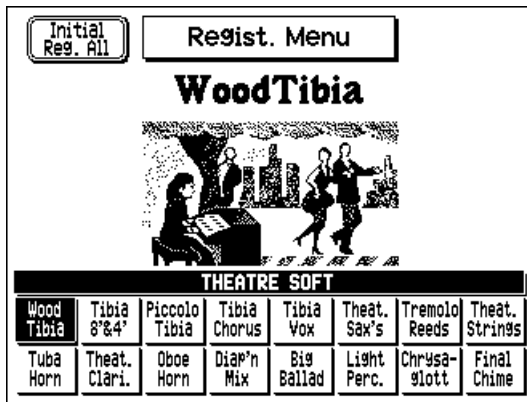

Press the Data Control button corresponding to the desired music style.  
(The selected Registration is highlighted.)

## 3. Try playing some songs that are suited to the selected Registration. Also, try playing the selected rhythm Style.

You may want to play along with the built-in rhythm Style as well, since each Registration includes suitable Style settings. To play the corresponding Style, simply press the START button in the ACCOMPANIMENT CONTROL section.

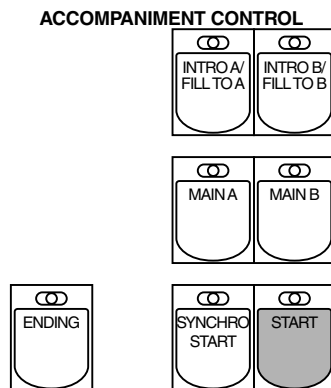

As you play chords in the Lower keyboard, you may also hear the automatic accompaniment of the Style. For more information on using automatic accompaniment, see page 45.

To stop the Style, press the START button again.

## 4. Try selecting and exploring other Registrations in the Registration Menus in the same way.



# Using the Display and Related Controls

As you've seen in the sections above, the AR-100 features an exceptionally large and easy-to-understand display. It provides comprehensive at-a-glance information on all current settings, and gives you convenient, intuitive control over the AR-100's functions.

In this section, we'll take a look at some example displays, and see how the surrounding panel buttons are used with them.

## 1. Call up the Help function by pressing the HELP button. To leave this display, press the HELP button again.

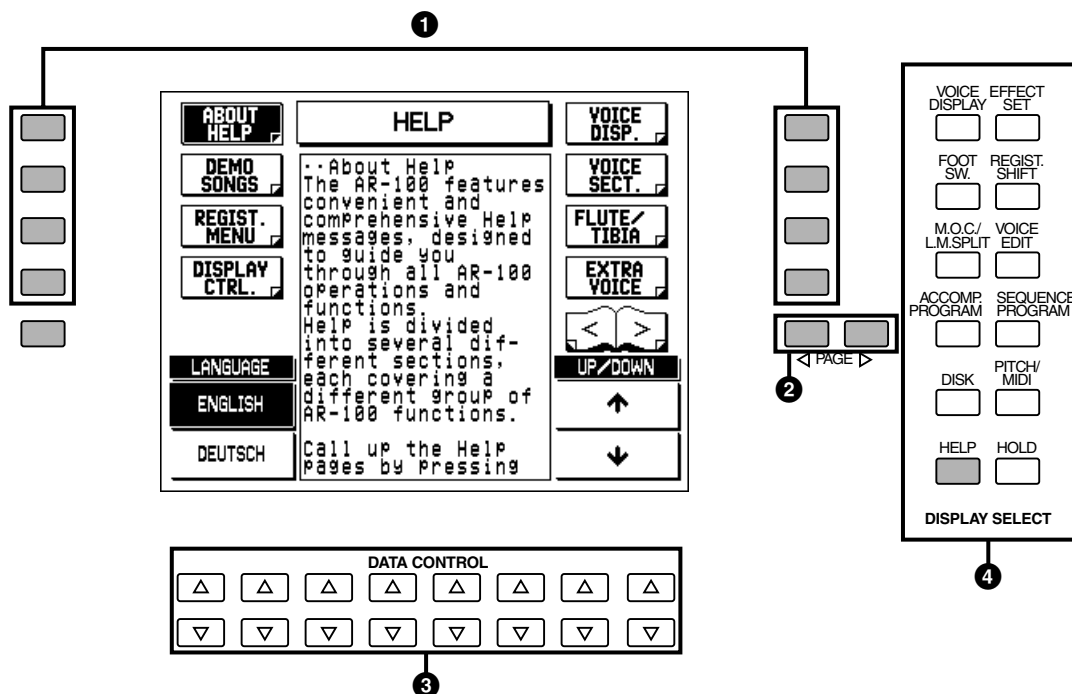

### 1 MENU buttons

These are used to select the corresponding Menu pages (when Menu pages are shown at the left and right sides of the display).

### 2 PAGE buttons

These buttons are used when the book icon appears in the display. Pressing one of the PAGE button selects the next or previous available page or group of Menu pages.

### 3 DATA CONTROL buttons

These are divided into eight sets of up/down buttons, and are used to make selections or adjust settings (up or down correspondingly) for functions shown directly above them. For example, use the four Data Control buttons directly underneath "UP/DOWN" in the display to scroll up or down in the current Help message. (Pressing either of the top two buttons scrolls up, and either of the bottom two scrolls down.)

### 4 DISPLAY SELECT buttons

These are used to select the various main functions and their pages. (Each button lights when the corresponding function is selected.) Pressing another function's button switches to the selected function. However, the function "freezes" when the VOICE EDIT, ACCOMP. PROGRAM, SEQUENCE PROGRAM, HELP, and HOLD buttons are pressed. To exit from these functions, press the same button again.

- 2. Let's take a look at some other ways the Data Control buttons are used. Press the STRINGS button in the UPPER KEYBOARD VOICE 1 section twice (or repeatedly until the display below appears).**

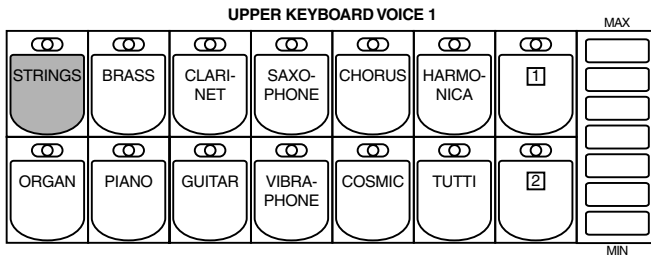

Use the Data Control buttons below each section in the display to change the corresponding settings.

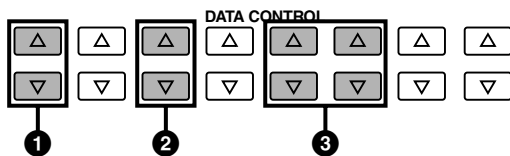
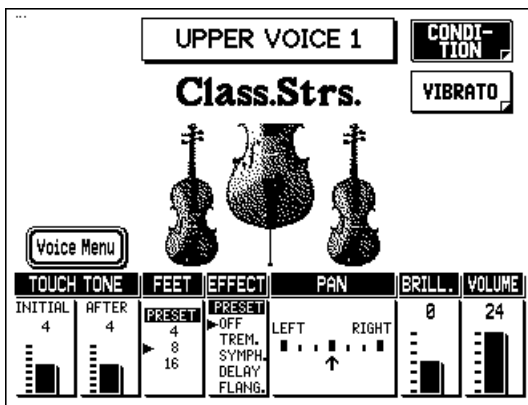

### 1 TOUCH TONE

Press the top button to increase the TOUCH TONE INITIAL value, and press the bottom one to decrease it. Holding down either button continuously changes the value.

### 2 FEET

Pressing either of these buttons changes the FEET setting. The selected setting is indicated by the dark pointer.

### 3 PAN

In this four-button group, the two left buttons move the pointer to the left, and the two right buttons move the pointer to the right.

# Help Messages

Before you go on to use some of the other features of the AR-100, you should explore the Help messages. This convenient function provides a comprehensive yet concise “on-line” guide covering all AR-100 operations and features. If there is an operation you’re unfamiliar with or if you need quick information on a function or feature, the relevant Help message is only a few button presses away.

Help is divided into many different sections, each covering a different group of AR-100 functions.

## To use Help:

### 1. Call up the Help pages by pressing the HELP button in the DISPLAY SELECT section.

The lamp of the button lights.

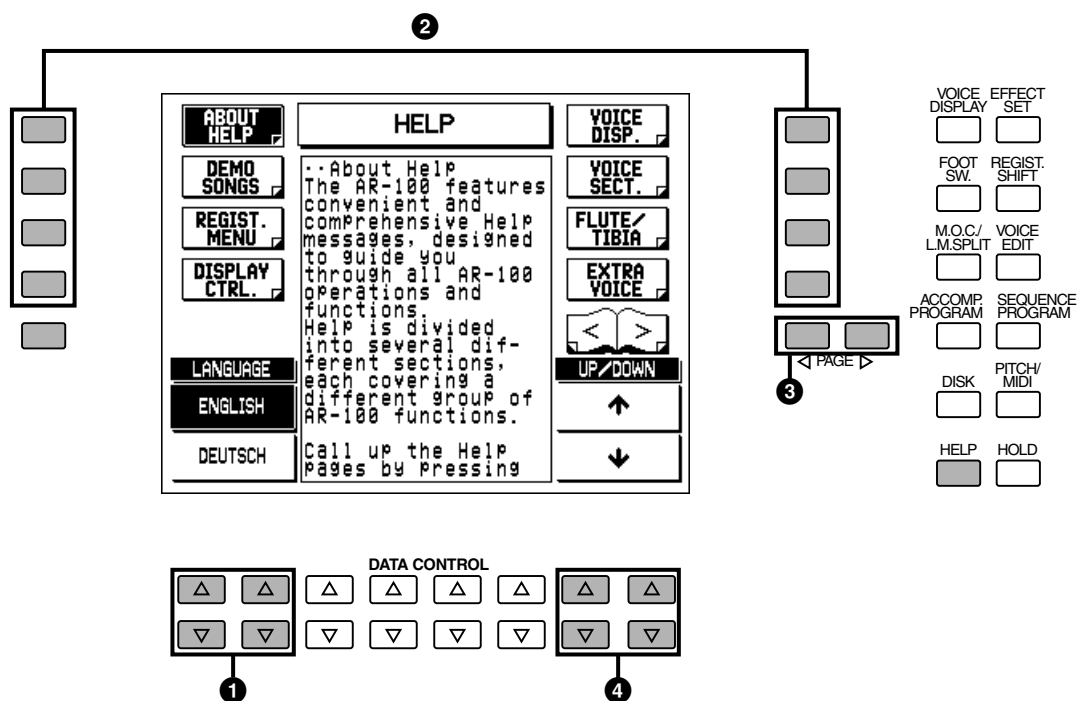

- ① Use these Data Control buttons to select the desired language. (Top buttons select ENGLISH, bottom buttons select DEUTSCH.)
- ② Use the Menu buttons to select the desired subject (Help Menu).
- ③ Use the PAGE buttons to scroll through the entire set of Help Menus.
- ④ Use these Data Control buttons to scroll up and down the individual “screens” of the selected Help Menu. (Top buttons scroll up, bottom buttons scroll down.)

### 2. Select the desired language (English or German).

Press one of the Data Control buttons corresponding to “ENGLISH” or “DEUTSCH.”

### 3. Select the desired Help Menu section.

Press the MENU button corresponding to the desired subject. Each Menu section covers a different subject (or group of functions) of the AR-100, and each has several "screens"

You can also scroll through the entire set of Help Menus by using the PAGE buttons.

### 4. Use the appropriate Data Control buttons to scroll up and down through the individual "screens" of the selected Menu.

Pressing one of the bottom two right Data Control buttons goes down one "screen" of the selected Help message. Pressing one of the top two right Data Control buttons goes up one "screen."

### 5. To leave the Help pages, press the HELP button again.

---

## Other Controls

---

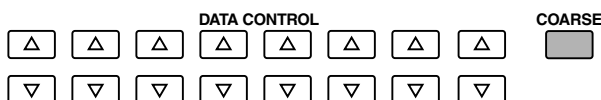

#### • COARSE button

This lets you make quick "jumps" when adjusting values. Simultaneously hold down the COARSE button and press the appropriate Data Control button. For example, in the above example display, hold down the COARSE button and press the bottom right Data Control button below VOLUME to quickly decrease the value.

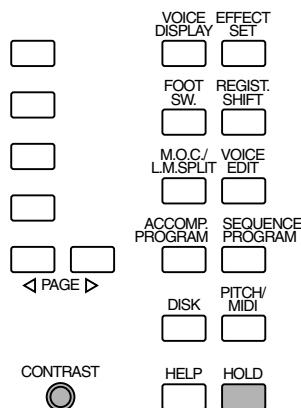

#### • HOLD button

This lets you keep the display at the current function. Normally, the display automatically changes when another function's button is pressed; the HOLD button disables that change. Pressing the button again cancels Hold.

#### • CONTRAST dial

Use this to adjust the display contrast for optimum viewing.

# Voice Sections

The AR-100 features a total of 205 realistic, high-quality AWM Voices. There are five Voice sections for the Upper keyboard, four Voice sections for the Lower keyboard, and four Voice sections for the Pedalboard. Each Voice section has its own Voice Condition page(s) (described on page 33), which allow you to make independent Voice, volume and other settings for each section.

## Selecting Voices

Since selection of Voices follows the same procedure throughout the various Voice sections, instructions for only Upper Keyboard Voice 1 are given here. In these instructions, you'll also learn how to set the volume for the Voice sections.

**To select Voices:**

### 1. First, turn on the desired Voice section in the ENSEMBLE buttons.

Press the UPPER VOICE 1 button to turn on Upper Keyboard Voice 1. (The button's lamp lights.)

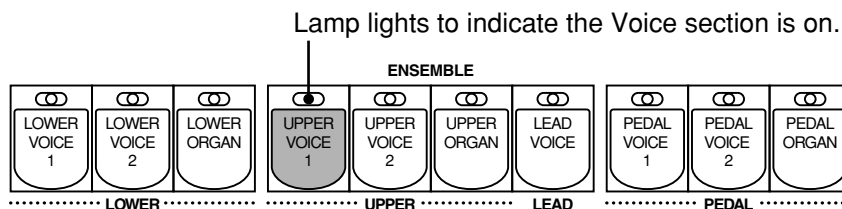

#### **NOTE**

The ORGAN Voice sections do not have preset Voices and thus are not selected in the same way. (See pages 26, 29 for details.)

### 2. Select the desired Voice by pressing one of the Voice buttons in the Voice section.

For example, if you have selected the ORGAN Voice, the following display (Voice Menu) will appear:

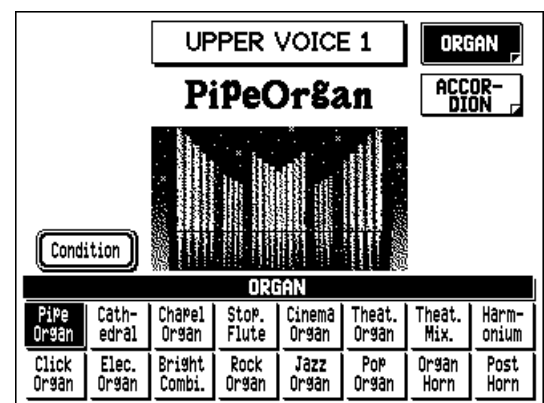
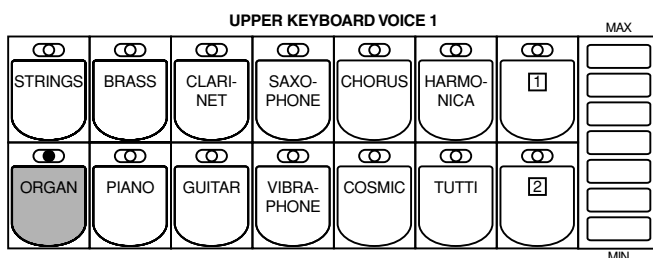

Notice that several different Voice names are shown at the bottom of this display. These are variations of the basic Organ Voice category.

#### **NOTE**

In addition to the 205 panel Voices, the AR-100 has many other Voices for playing back commercially available XG and DOC song data.

**3. Press the Data Control button corresponding to the voice you wish to select.**

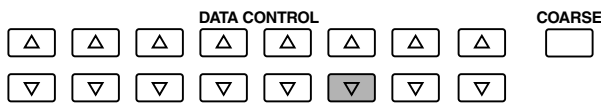
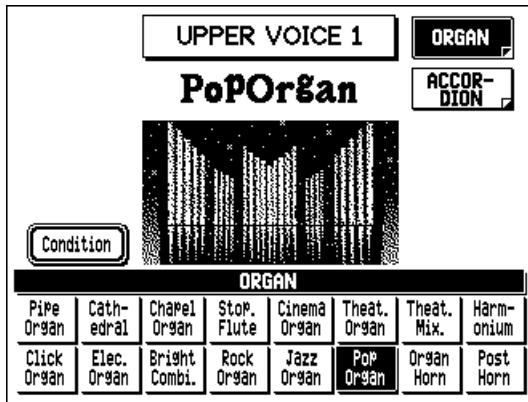

The name of the selected Voice appears at the top of the display. In this case, Pop Organ is shown.

Some Voices (such as Organ and Guitar) have two pages of Voices. To select the desired page, press the Menu button next to it.

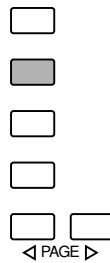
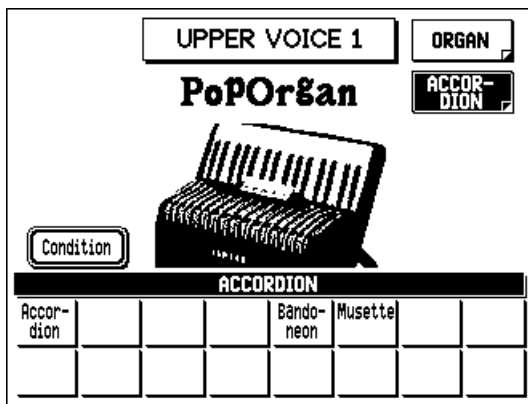

**4. Select Voices for the other Upper Voice sections in the same way (steps #1 - #3 above), if desired.**

**5. Set the volume for each active Voice section.**

There are two volume controls: Coarse and Fine.

## Coarse:

Use the touch controls at the right of each Voice section on the panel to set the desired level for each Voice. The controls have seven volume settings, from a minimum of 0 (MIN) to a maximum of 24 (MAX). (The lamps on the controls light to indicate the volume.)

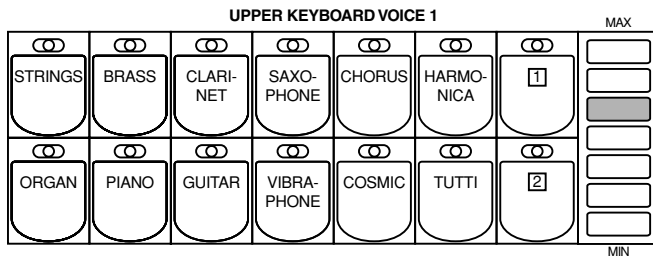

## Fine:

Fine adjustments to the volume are made from the Voice Condition page. You can select this page in one of three ways:

- Press the same panel Voice button again.
- Press the same Data Control button corresponding to the selected Voice.
- Press the Menu button corresponding to “Condition” in the display.

### **NOTE**

- Pressing a Voice button once calls up that Voice’s Voice Menu display. Pressing it again (or the Menu button next to “Condition”) calls up the Voice Condition page. Successive presses of either button toggle between the Voice Condition and Voice Menu pages.
- You can also make fine volume settings from the Voice Display page. (See page 23.) For more information on the Voice Condition controls and other Voice-related settings, see “Voice Controls and Effects” (page 32).

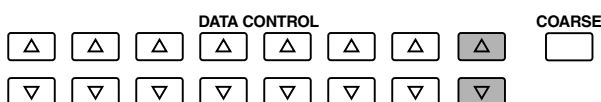
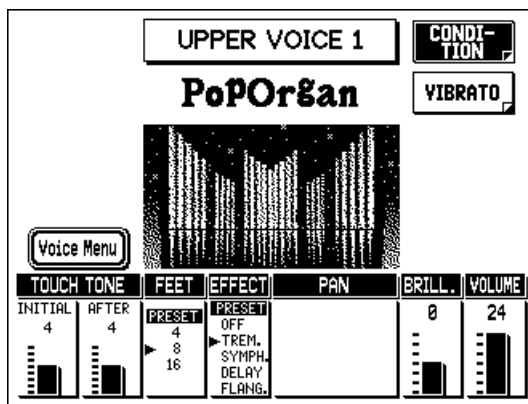

Use the Data Control buttons directly under VOLUME in the display to change the level of the selected Voice. The level is indicated both by a numeric value (0 – 24) and a graphic bar.

6. Now select Voices for the Lower keyboard and Pedalboard as you did for the Upper keyboard above. Also set the volumes of the Voices.
7. Adjust the volume balance between the Upper and Lower Voices with the MANUAL BALANCE touch control. Adjust the overall level of the Pedal Voices with the PEDAL BALANCE touch control.

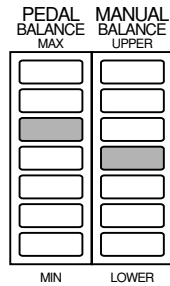

**NOTE**

The Lead and Pedal Voices sound one note at a time; when you simultaneously press two or more keys, only the highest note will sound.

**NOTE**

You can also change the manual balance (in fine steps) from the Voice Display page. (See page 24.)

### About TO LOWER – Playing Lead and Pedal Voices from the Lower keyboard:

The AR-100 has a special “To Lower” function that lets you assign Lead or Pedal Voices to the Lower keyboard. Simply press the TO LOWER button in the appropriate Voice section, and that section’s Voice will be playable from the Lower keyboard.

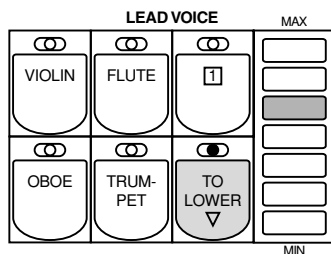

**NOTE**

When the TO LOWER button is turned on, the Lead Voices and Pedal Voices cannot be played on the Upper keyboard and Pedalboard, respectively.

### Turning Voice Sections On and Off

The Voices of the various Voice sections in each keyboard sound together in a layer, and the balance of the Voices in the layer is determined by the controls described above. You can easily mute (or unmute) a particular Voice section by pressing the appropriate button in the ENSEMBLE section. (The button’s lamp lights when the section is on.)

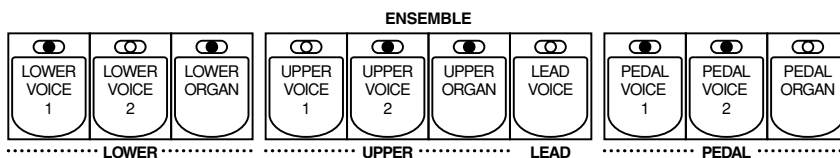



## Selecting Voices from the Dotted Buttons

The AR-100 has a wide variety of Voices from which you can choose — far greater than what is immediately apparent from the front panel controls. You've already learned in the section above how to select the different Voices that are available in the Voice Menu display of each panel Voice. The AR-100 also has dotted buttons in each Voice section, giving you access to even more Voices — including Voices you've created yourself (User Voices) by using the Voice Edit function. (See page 114.)

Each Voice section has one or two dotted buttons, found on the right side of each Voice section. These dotted buttons function as “wild card” Voice Menu selectors; any internal or User Voices can be selected from these buttons.

### The dotted buttons have three basic uses:

- **For playing any Voice of the Voice Menus from any of the keyboards or Pedalboard.** For example, you can play any Voice from the various Voice Menu pages (including User), and not be limited to only the twelve Voice Menus available from the Upper keyboard panel buttons.
- **For having three different Voices from the same Voice Menu page available at the same time.** For example, you can assign one of the Guitar Voices to a dotted button in the Upper Keyboard Voice 1 section, a different Guitar Voice to the other dotted button, and select the third Guitar Voice from the GUITAR button.
- **For playing the User Voices of your own creation. (See page 114.)**

### To select Voices from the dotted buttons:

1. Press one of the dotted buttons in the desired Voice section.

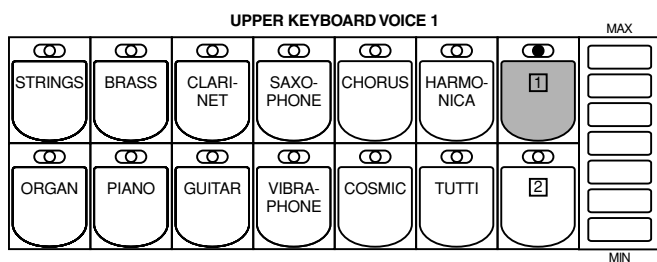

2. Scroll through the various categories with the PAGE buttons.

### 3. Select a specific Voice Menu (GUITAR, for example) by pressing corresponding Menu button.

Select specific pages with the Menu buttons.

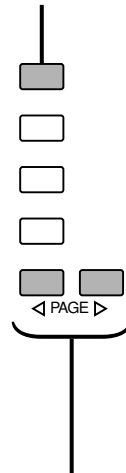
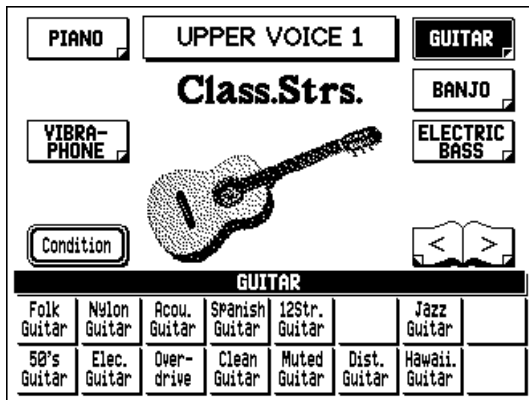

#### NOTE

The Voice name at the top of the display is that of the currently assigned Voice and is unrelated to the Voice menu at the bottom.

Use the PAGE buttons to scroll through the various Voice categories.

Each page represents a general Voice category and the category title appears in the dark bar at the top of the menu when the page has been selected.

### 4. Select a specific Voice from the display (for example, Muted Guitar) by using the Data Control buttons.

The name of the selected Voice appears at the top of the display.

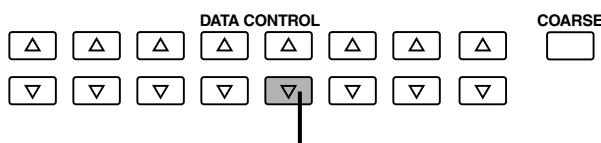
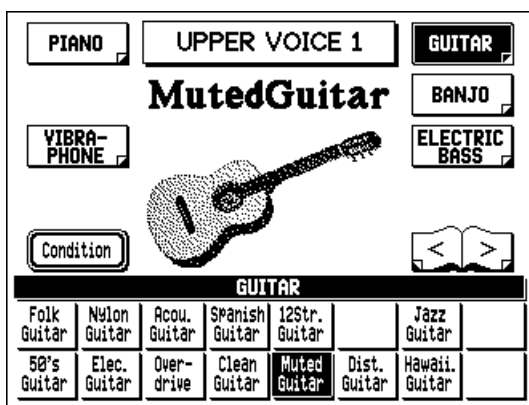

Use the Data Control buttons to select a Voice.

## To select User Voices:

Select the USER Voice Menu (by the same method above) when you wish to play Voices that you've created in Voice Edit (see page 114).

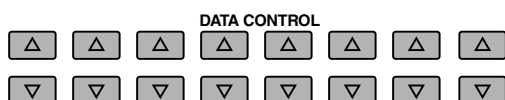
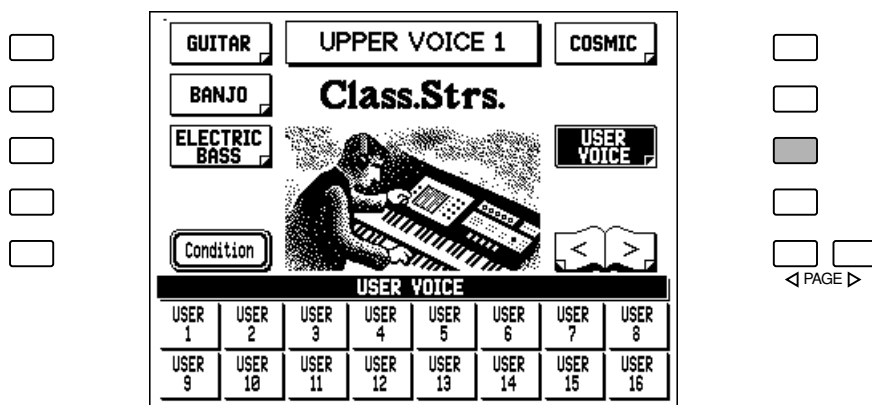

### **NOTE**

You can directly view and select Voice Menu pages by holding down one of the dotted buttons and simultaneously pressing the desired Voice buttons in succession.

## Voice Menus / Voice List

The following list shows the Voice categories and the available Voices.

### 1. UPPER/LOWER KEYBOARD VOICE

STRINGS							
Class. Strs.	Popular Strs.	Bowed Strs.	Chamber Strs.	Orch. Strs.	Full Strs.		Organ String
Pizz. Strs.	Trem. Strs.			Synth. Strs.1	Synth. Strs.2	Synth. Strs.3	

### 2. LEAD VOICE

VIOLIN							
Orch. Violin	Jazz Violin	Pizz. Violin	Synth. Violin	Cello			
Fiddle	Kokyu						

### 3. PEDAL VOICE

CONTRA BASS							
Contra Bass1	Contra Bass2	Bass Solo		Pizz. Bass		Upright Bass	Acou. Bass

### 4. UPPER/LOWER KEYBOARD VOICE

BRASS							
Fanfare Brass	Bigband Brass	Pop Brass	Orch. Brass	Brass Section	Brass Ensem.	Brass Band	
Synth. Brass1	Synth. Brass2	Synth. Brass3	Synth. Brass4				

### 5. LOWER KEYBOARD VOICE

HORN							
French Horn	Horn Ensem.	Horn	Muted Horn				

### 6. LEAD VOICE

TRUMPET							
Class. Trp.	Dixie Trp.	Cornet	Jazz Trp.	Bright Trp.	Muted Trp.		
Smooth Trb.	Band Trb.	Muted Trb.		Flugel Horn		Eupho-nium	

### 7. PEDAL VOICE

TUBA							
Tuba				Timpani	Timp. Roll		

### 8. LEAD VOICE

FLUTE							
Solo Flute	Orch. Flute	Jazz Flute		Piccolo			
Recorder	Ocarina	Pan Flute	Shaku-hachi	Whistle	Blown Bottle		

### 9. LEAD VOICE

OBOE							
Orch. Oboe	Solo Oboe	English Horn		Orch. Bassoon	Solo Bassoon		
Bagpipe							

### 10. UPPER/LOWER KEYBOARD VOICE

CLARINET							
Orch. Cla.	Dixie Cla.			Synth. Cla.		Square Lead1	Square Lead2

11. UPPER/LOWER KEYBOARD VOICE

SAXOPHONE							
Alto Sax.	Jazz Alto	Tenor Sax.	Breathy Tenor	Jazz Tenor		Soprano Sax.	Bari. Sax.
Sax. Section	Sax. Ensem.			Saw. Lead1	Saw. Lead2		

12. UPPER/LOWER KEYBOARD VOICE

TUTTI							
Octave Strs.	Strs. & Brass	Octave Brass	Band Tutti	Wind. Ensem.	Wind. Quintet	Brass Quintet	
Str. & Piano	Str. & Choir	Str. & Harpsi.	Str. & Bell	Str. & Horn		Orch. Hit	

13. UPPER/LOWER KEYBOARD VOICE

CHORUS							
Choir	Choir Ooh	Choir Aah		Synth. Chorus1	Synth. Chorus2	Synth. Chorus3	
Vocal Doo							

14. UPPER KEYBOARD VOICE

HARMONICA							
Harmo-nica	Blues Harm.						

15. UPPER/LOWER KEYBOARD VOICE

ORGAN							
Pipe Organ	Cath-edral	Chapel Organ	Stop. Flute	Cinema Organ	Theat. Organ	Theat. Mix.	Harm-onium
Click Organ	Elec. Organ	Bright Combi.	Rock Organ	Jazz Organ	Pop Organ	Organ Horn	Post Horn

16. UPPER/LOWER KEYBOARD VOICE

ACCORDION							
Accor-dion				Bando-neon	Musette		

17. PEDAL VOICE

ORGAN BASS							
8ft.	16ft.	8+16ft.	Pipe Bass	Toc-cata	32ft. Mix.		

18. UPPER/LOWER KEYBOARD VOICE

PIANO							
Grand Piano	Mellow Piano	Octave Piano	Honky Tonk	Harpsi-chord	Grand Harpsi.	Clavi-chord	Dulci-mer
DX E.Piano	Stage E.Piano	Bright E.Piano	Elec. Piano	Piano& E.Piano		Clavi.	Synth. Clavi.

19. UPPER/LOWER KEYBOARD VOICE

VIBRAPHONE							
Vibra- phone	Soft Vibes	Gloc-ken.	Chry-soglott	Celesta	Music Box	Kalimba	
Rep. Marimba	Marimba	Xylo- phone		Chime	Synth. Chime	Steel Drum	

20. UPPER/LOWER KEYBOARD VOICE

GUITAR							
Folk Guitar	Nylon Guitar	Acou. Guitar	Spanish Guitar	12Str. Guitar		Jazz Guitar	
50's Guitar	Elec. Guitar	Over-drive	Clean Guitar	Muted Guitar	Dist. Guitar	Hawaii. Guitar	

21. UPPER/LOWER KEYBOARD VOICE

BANJO							
Banjo	Mando- lin	Lute	Sitar	Shami-sen			
Harp				Koto	Taisho-koto		

22. PEDAL VOICE

ELECTRIC BASS							
Fingerd Bass	Slap Bass1	Picked Bass	Fret-less	Flange Bass	Slap Bass2	Muted Bass	
Synth. Bass1	Synth. Bass2	Synth. Bass3	Synth. Bass4				

23. UPPER/LOWER KEYBOARD VOICE

COSMIC							
NewAge Pad1	NewAge Pad2	Warm Pad	Cosmic Pad	Poly-synth	Waspy Synth.	Bright-ness	Sci-Fi
Sound-track				Sea-shore	Bird Tweet	App-lause	

24. USER

USER VOICE							
USER 1	USER 2	USER 3	USER 4	USER 5	USER 6	USER 7	USER 8
USER 9	USER 10	USER 11	USER 12	USER 13	USER 14	USER 15	USER 16

# Voice Display

The Voice Display is the “home” or default display for the AR-100 and provides at-a-glance information on some of the most important settings for the instrument. These include:

- Current Voice selections for each Voice section. (The active Voice sections are highlighted.) For the Flute/Tibia (Organ) sections, the active sections are highlighted.
- Organ Variation setting.
- Current Style selection.
- Transpose setting.
- Chord root and type (the currently played chord in the Lower keyboard).

The Voice Display is automatically called up when you turn on the AR-100. You can also call it up by pressing the VOICE DISPLAY button in the DISPLAY SELECT section.

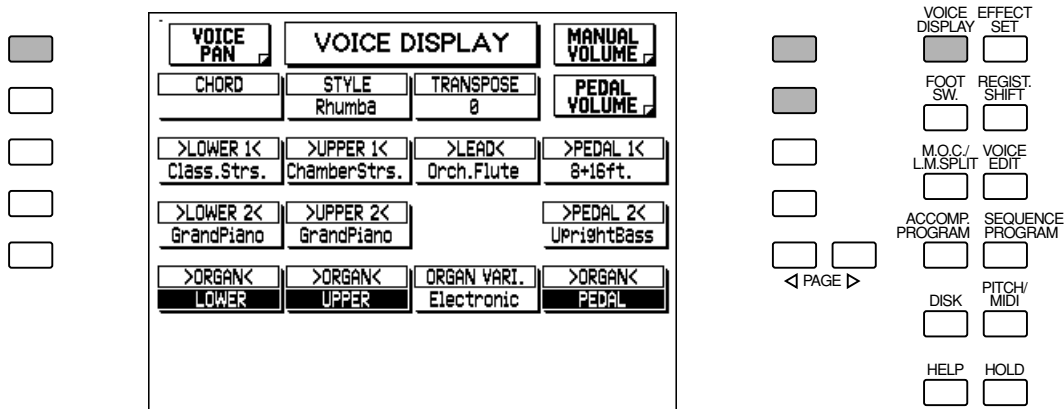

The Voice Display also has Menu Pages for Manual Volume, Pedal Volume, and Voice Pan settings. Use the appropriate Menu button to select the desired page.

## MANUAL VOLUME Page

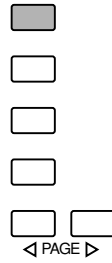

DATA CONTROL

COARSE

- ❶ LOWER 1 and 2
- ❷ UPPER 1 and 2
- ❸ LEAD
- ❹ MANUAL BALANCE

This determines the overall balance between the Upper and Lower Keyboard levels. MANUAL BALANCE is shown as a slider graphic; higher slider settings make the Upper Voices relatively louder, while lower settings make the Lower Voices relatively louder. This can also be set from the MANUAL BALANCE touch control.

## PEDAL VOLUME Page

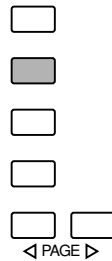

DATA CONTROL

COARSE

### ❶ STYLE Controls

#### • RHYTHM

This determines the level of the rhythm (drum and percussion) parts of the Style and the Keyboard Percussion sounds. This can also be set from the panel RHYTHM touch controls.

#### • B/C (Bass/Chord)

This determines the level of the bass and chord accompaniment of the Style. This can also be set from the panel BASS/CHORD touch controls.

## ② PEDAL Controls

- 1, 2

These determine the volume of each Pedal Voice section. These can also be set from the respective panel touch controls.

## ③ PEDAL BALANCE

This determines the level of the Pedal Voice sections. PEDAL BALANCE is shown as a slider graphic; higher slider settings make the Pedal Voices louder. This can also be set from the PEDAL BALANCE touch control.

## VOICE PAN Page

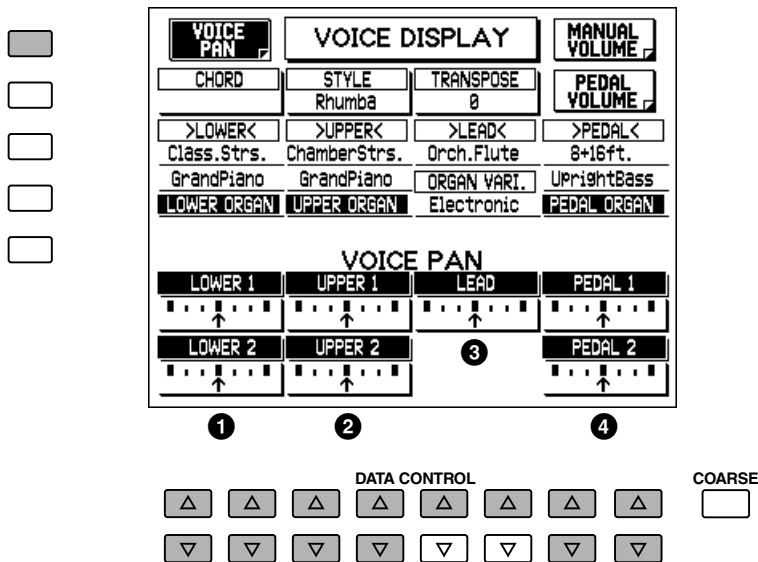

- ① LOWER 1 and 2
- ② UPPER 1 and 2
- ③ LEAD
- ④ PEDAL 1 and 2

These determine the pan setting (stereo position) of each section. Use the corresponding Data Control buttons. Setting this arrow indication to the left puts the sound of the selected Voice toward the left speaker/channel. Setting it to the right puts the sound toward the right. Seven pan positions are available.

These settings are also available in the Voice Condition page for each Voice section. When an effect has been turned on for a Voice section (see page 34), the corresponding section in this page is disabled.

---

## ***Saving and Recalling Panel Settings***

---

Turning the AR-100 off or selecting different Registrations (see page 9) erases all settings you have made. If you have made settings you wish to keep, save them to Registration Memory (see page 73) before turning the AR-100 off. However, you can recall the panel settings before the AR-100 was last turned off. See page 80 for more information.

# Flute/Tibia and Extra Voice

The Flute/Tibia and Extra Voice sections provide a variety of popular and traditional organ sounds. Used together or separately, they give you the sounds and the convenient, intuitive control found on conventional organs.

## Flute/Tibia (Theatre)

The Flute/Tibia section allows you to create your own organ voices. With this function you can recreate popular organ sounds by adjusting the flute footage levels directly from the convenient panel touch controls.

The Upper Flute/Tibia features nine footage settings, with four additional footage settings for the Attack/Chiff sound. The Lower section has seven footage settings, and the Pedal section has three. Click settings are available for all sections.

## Creating Flute/Tibia Voices

### Setting Footages

1. Turn off all Voice sections for the appropriate keyboard (in the ENSEMBLE section), except the Organ section.

For example, press the UPPER and LEAD buttons in the ENSEMBLE section until only the UPPER ORGAN button's lamp is lit.

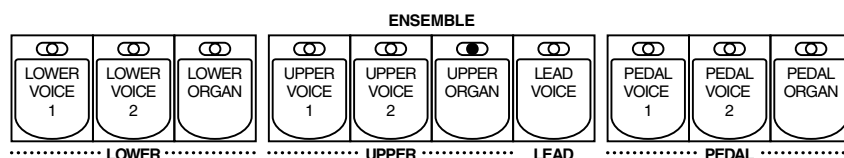



## 2. Select one of the Organ Variations: Theatre, Jazz, Electronic, or Classical.

Press the ORGAN VARIATION button. This calls up the FLUTE and EXTRA VOICE pages (shown below). Each successive press of the button selects a different Organ Variation. You can also select the Organ Variations by pressing the appropriate Menu buttons.

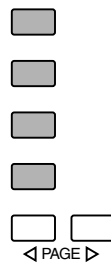
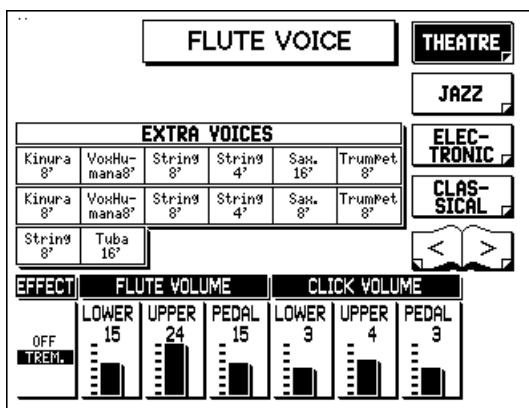
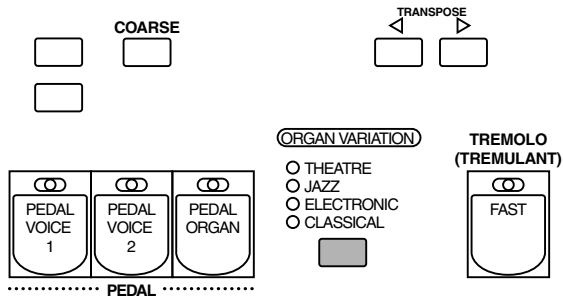

## 3. Use the touch controls in the appropriate FLUTE/TIBIA section to change each footage volume.

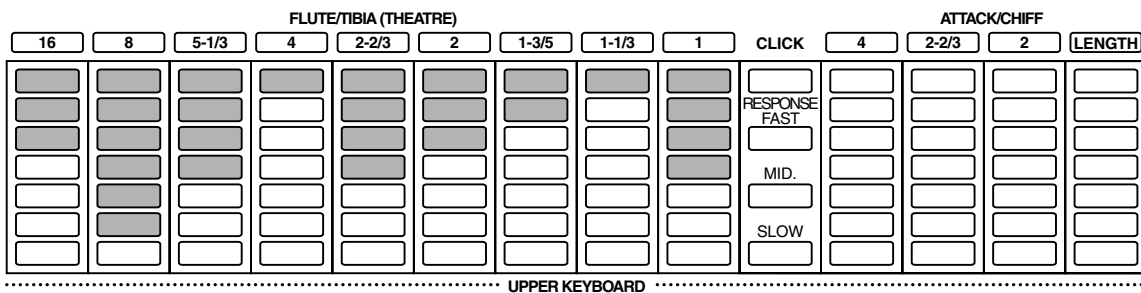

Play the keyboard and listen to the changes in the sound as you adjust the footage volumes. (You may need to set the overall Flute/Tibia level to properly hear the Voices; see the next step.)

#### 4. Turn the Tremolo effect on or off for the Flute Voices, if desired. Also set the Flute Volume and Click Volume as needed.

##### EFFECT

This turns Tremolo on or off for the Flute/Tibia Voices. (As with the other Voice sections, this enables Tremolo. To actually turn Tremolo on, use the panel TREMOLO button. To make changes to the Tremolo settings, see page 40.)

##### NOTE

The Symphonic/Celeste, Delay and Flanger effects cannot be applied to the Flute/Tibia Voice sections.

##### FLUTE VOLUME (LOWER, UPPER, PEDAL)

Determines the overall Flute/Tibia Voice level for the Lower and Upper keyboards and Pedalboard, respectively. Range: 0 – 24

##### CLICK VOLUME (LOWER, UPPER, PEDAL)

Determines the Click level for the Lower and Upper keyboards and Pedalboard, respectively. Click produces a sharp key click sound. Click must be turned on from the panel (see "Setting the Click and Response" below). Range: 0 – 6

### Setting the Click and Response

To set Click and Response, use the controls to the right of each Flute/Tibia section.

FLUTE/TIBIA (THEATRE)									ATTACK/CHIFF				
16	8	5-1/3	4	2-2/3	2	1-3/5	1-1/3	1	CLICK	4	2-2/3	2	LENGTH
<input type="checkbox"/>	<input type="checkbox"/>	<input type="checkbox"/>	<input type="checkbox"/>	<input type="checkbox"/>	<input type="checkbox"/>	<input type="checkbox"/>	<input type="checkbox"/>	<input type="checkbox"/>	<input type="checkbox"/>	<input type="checkbox"/>	<input type="checkbox"/>	<input type="checkbox"/>	<input type="checkbox"/>
<input type="checkbox"/>	<input type="checkbox"/>	<input type="checkbox"/>	<input type="checkbox"/>	<input type="checkbox"/>	<input type="checkbox"/>	<input type="checkbox"/>	<input type="checkbox"/>	<input type="checkbox"/>	RESPONSE	<input type="checkbox"/>	<input type="checkbox"/>	<input type="checkbox"/>	<input type="checkbox"/>
<input type="checkbox"/>	<input type="checkbox"/>	<input type="checkbox"/>	<input type="checkbox"/>	<input type="checkbox"/>	<input type="checkbox"/>	<input type="checkbox"/>	<input type="checkbox"/>	<input type="checkbox"/>	FAST	<input type="checkbox"/>	<input type="checkbox"/>	<input type="checkbox"/>	<input type="checkbox"/>
<input type="checkbox"/>	<input type="checkbox"/>	<input type="checkbox"/>	<input type="checkbox"/>	<input type="checkbox"/>	<input type="checkbox"/>	<input type="checkbox"/>	<input type="checkbox"/>	<input type="checkbox"/>	MID.	<input type="checkbox"/>	<input type="checkbox"/>	<input type="checkbox"/>	<input type="checkbox"/>
<input type="checkbox"/>	<input type="checkbox"/>	<input type="checkbox"/>	<input type="checkbox"/>	<input type="checkbox"/>	<input type="checkbox"/>	<input type="checkbox"/>	<input type="checkbox"/>	<input type="checkbox"/>	SLOW	<input type="checkbox"/>	<input type="checkbox"/>	<input type="checkbox"/>	<input type="checkbox"/>
<input type="checkbox"/>	<input type="checkbox"/>	<input type="checkbox"/>	<input type="checkbox"/>	<input type="checkbox"/>	<input type="checkbox"/>	<input type="checkbox"/>	<input type="checkbox"/>	<input type="checkbox"/>	<input type="checkbox"/>	<input type="checkbox"/>	<input type="checkbox"/>	<input type="checkbox"/>	<input type="checkbox"/>
..... UPPER KEYBOARD .....													

##### CLICK

Turns the key click sound on and off. (The lamp lights when Click is on.)

##### RESPONSE (FAST, MID., SLOW)

Determines the overall response speed of the sound. The FAST setting results in a quicker keyboard response, while SLOW results in a slower response.

## Setting Attack/Chiff (Upper Keyboard only)

Attack/Chiff is a special set of footages for the Upper Keyboard that produces a percussive sound, like that on conventional organs. The length of the percussive sound is also adjustable. To set Attack/Chiff, use the ATTACK/CHIFF touch controls. The actual sound differs depending on the Organ Variation selected. For Jazz and Electronic, this functions as Attack, reproducing the percussive attack on popular conventional organs. For Theatre and Classical, this functions as Chiff, reproducing the breathy noise of a pipe organ.

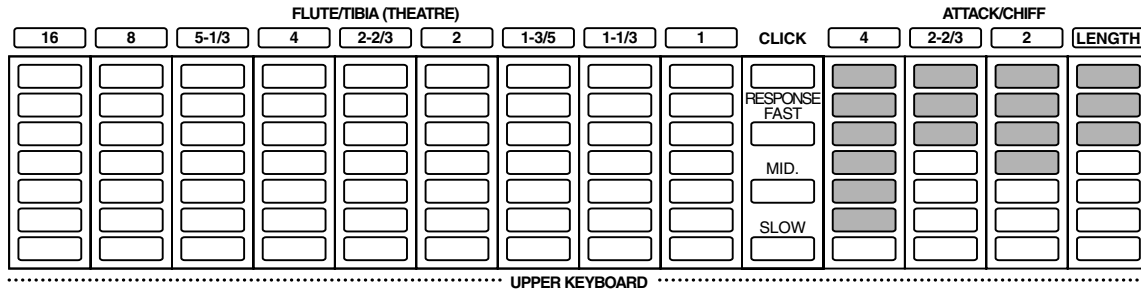

The numbered touch controls set the footage for the Attack/Chiff sound. The LENGTH touch control determines the duration of the Attack sound.

## Extra Voice

The Extra Voice sections provide a variety of additional Voices for the four Organ Variations — Theatre, Jazz, Electronic, and Classical. Though they can be used on their own, they are essentially designed to supplement the Flute/Tibia sections. The Upper and Lower keyboards each have six Extra Voices, and the Pedalboard has two.

To use the Extra Voice sections:

1. Turn off all Voice sections for the appropriate keyboards (in the ENSEMBLE section), except the Organ sections.

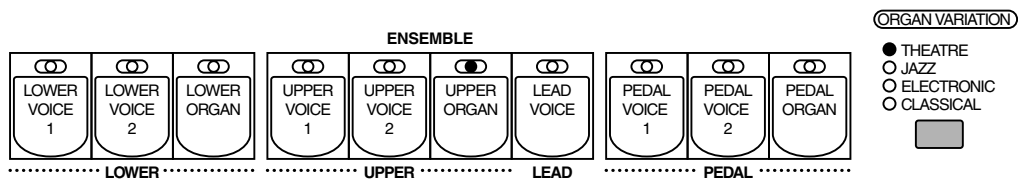

If you want to use the Extra Voices by themselves, also make sure that the Flute/Tibia touch controls are all set to minimum.

2. Select the Organ Variation category (Theatre, Jazz, Electronic, or Classical) by pressing the appropriate Menu button, or by using the ORGAN VARIATION button (as you did on page 27).

### 3. Press one of the buttons in one of the Extra Voice sections.

This turns on the selected Voice (the button's lamp lights) and automatically calls up the FLUTE VOICE and EXTRA VOICE pages.

Upper Keyboard Extra Voice section.  
Selected Voice is highlighted.  
Lower Keyboard Extra Voice section.  
Pedalboard Extra Voice section.

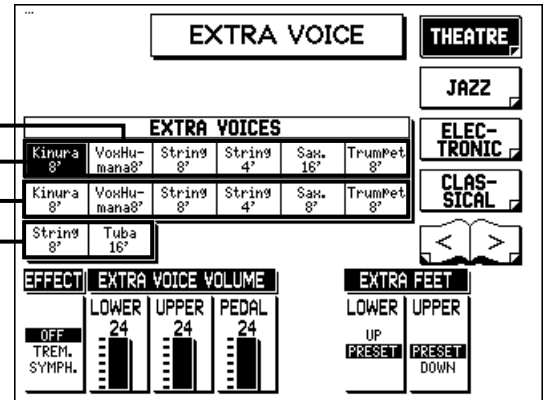

----- LOWER KEYBOARD EXTRA VOICE -----

KINURA 8	VOX HUM. 8	STRING 8	STRING 4	SAX. 8	TRUMP. 8	<input type="radio"/>
OBOE 8	CLARI. 8	STRING 8	STRING 4	TROMB. 8	HORN 8	<input type="radio"/>
FLUTE 16	DIAP. 8	OCT. 4	SU. OCT. 2	MIX. IV	TRUMP. 8	<input type="radio"/>

ORGAN VARIATION

THEATRE  
 JAZZ/ELECTRONIC  
 CLASSICAL

----- UPPER KEYBOARD EXTRA VOICE -----

<input checked="" type="radio"/>	KINURA 8	VOX HUM. 8	STRING 8	STRING 4	SAX. 16	TRUMP. 8
<input type="radio"/>	OBOE 8	CLARI. 8	STRING 8	STRING 4	TROMB. 16	TRUMP. 8
<input type="radio"/>	DIAP. 16	OCT. 8	GAMBA 8	MIX. IV	OBOE 8	CLAIR. 4

ORGAN VARIATION      EXTRA VOICE

THEATRE     STRING 8     TUBA 16  
 JAZZ/ELECTRONIC     STRING 8     TUBA 16  
 CLASSICAL     MIX. IV     TRUMP. 8

PEDALS -----

#### **NOTE**

Unlike the other Voice sections, Extra Voice allows you to simultaneously use two or more Voices.

### 4. Add other Voices by pressing other buttons in the appropriate EXTRA VOICE sections.

The selected Voices are highlighted in the display and their buttons' lamps light.

**5. From the EXTRA VOICE page, make additional settings for the Extra Voices.** The EXTRA VOICE page automatically appears when you press one of the EXTRA VOICE buttons, except when the FLUTE VOICE page is active — in which case you can use the PAGE buttons to select the EXTRA VOICE page.

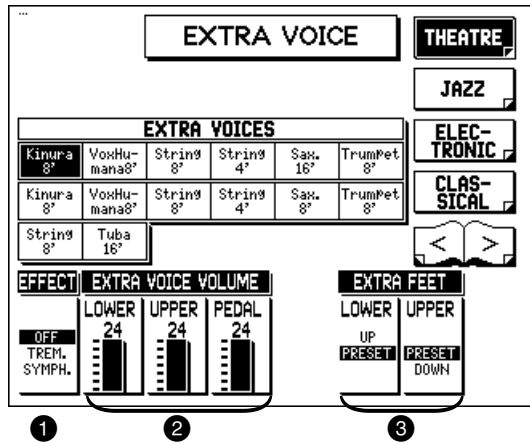

**1 EFFECT**

This determines the effect type (Tremolo or Symphonic) for the Extra Voice sections.

- OFF: Cancels the effect.
- TREM. (Tremolo): Enables Tremolo for the Extra Voice sections. (To actually turn Tremolo on, use the panel TREMOLO button. To make changes to the Tremolo settings, see page 40.)
- SYMPH. (Symphonic): Selects the Symphonic/Celeste effect. (See page 37).

**NOTE**

The Delay and Flanger effects cannot be applied to the Extra Voice sections.

**2 EXTRA VOICE VOLUME (LOWER, UPPER, PEDAL)**

Determines the overall Extra Voice level for the Lower and Upper keyboards and Pedalboard, respectively. Range: 0 – 24

**3 EXTRA FEET (LOWER, UPPER)**

Determines the octave (or footage) for the Extra Voice Lower and Upper sections. When set to “PRESET,” the octave setting is normal. “UP” (Lower only) raises the pitch by one octave, and “DOWN” (Upper only) lowers it by one octave.

**6. If desired, make settings for the Flute/Tibia Voice section(s) and mix them with the Extra Voice section(s).**

# Voice Controls and Effects

The AR-100 features two general kinds of functions that can be used to control or change the sound of the Voices: Voice controls and effects.

Voice controls are used to change various basic settings for the Voices, such as volume, octave (Feet), Pan, Vibrato, touch sensitivity (Touch Tone) and Brilliance. The Voice controls, as well as the selection of certain effects, are provided in the Voice Condition pages (described below).

Effects are an extremely versatile set of tools through which you can dramatically change and enhance the sound of the Voices. They include: Reverb, Sustain, Tremolo, Symphonic, Delay, and Flanger. Most effect settings are controlled from the Effect Set pages. (Controls for Reverb, Sustain, and Tremolo On/Off are provided on the panel.)

The chart below shows the various Voice controls and effects for the individual Voice sections. Available functions are indicated by circles.

		Touch Tone (Initial / After)	Feet	Pan	Brilliance	Vibrato	Lead Slide	Lead Tune	Symphonic / Celeste	Delay	Flanger	Reverb	Sustain	Tremolo
Upper	Upper Keyboard Voice 1	○	○	○	○	○			○	○	○	○		○
	Upper Keyboard Voice 2	○	○	○	○	○			○	○	○	○	○	○
	Flute / Tibia	-	-	-	-	-			-	-	○	○	○	○*
	Extra Voice	-	○	-	-	-			○*	-	-	○	○	○*
Lower	Lower Keyboard Voice 1	○	○	○	○	○	-	-	○	○	○	○	○	○
	Lower Keyboard Voice 2	○	○	○	○	○			○	○	○	○	○	○
	Flute / Tibia	-	-	-	-	-			-	-	○	○	○	○*
	Extra Voice	-	○	-	-	-			○*	-	-	○	○	○*
Lead	Lead Voice	○	○	○	○	○	○	○	○	○	○	○	-	○
Pedal	Pedal Voice 1	-	○	○	○				○	○	○	○	○	○
	Pedal Voice 2	-	○	○	○				○	○	○	○	○	○
	Flute / Tibia	-	-	-	-	-	-	-	-	-	-	○	○	-
	Extra Voice	-	-	-	-	-	-	-	-	-	-	○	○	-
Related Pages	Voice Condition Page	○	○	○	○	-	-	-	○	○	○			○
	Vibrato Page					○	○	○						-
	Flute Voice Page		-										-	○*
	Extra Voice Page	-	○	-	-				○*	-	-			○*
	Reverb Pages					-	-	-				○		-
	Sustain Page												○	-
	Effect Set Pages								○	○	○		-	○

\* This sets the type of effect applied to each voice section. Further effect settings should be done from the page of the corresponding effect.

## To change the desired Voice control or effect setting, select the appropriate page:

- For Touch Tone, Feet, Effect On/Off/Type (Tremolo, Symphonic, Delay, and Flanger), Pan, Brilliance, Volume, and Vibrato —Select the Voice Condition pages (see below).
- For Tremolo, Symphonic, Delay, and Flanger parameter settings —Select the Effect Set page by pressing the EFFECT SET button.
- For Reverb, Sustain, and Tremolo parameter settings —Press the corresponding panel button, then select the appropriate menu in the display.

---

## Voice Condition Pages

---

### You can call up the Voice Condition pages in one of three ways:

- Press the same panel Voice button twice.
- Press the same Data Control button corresponding to the just selected Voice.
- Press the Menu button corresponding to “Condition” from the Voice Menu page.

The Voice Condition pages of the various Voice sections have slight differences in their functions. Each Voice control in these pages is applied independently to each Voice section.

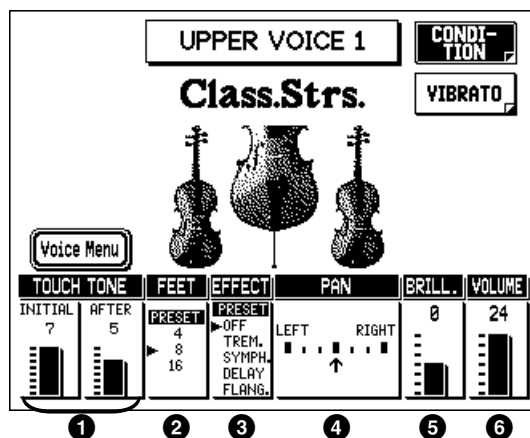

### 1 TOUCH TONE

The Touch Tone function gives you expressive control over the volume and timbre of a Voice. Two types of keyboard touch affect this function: Initial Touch and After Touch.

All Voices are provided with this expressive function, making it possible to perfectly reproduce the subtle dynamic and tonal changes of actual instruments. For example, piano Voices sound much brighter when you play the keys strongly, especially in the attack portion of the sound — exactly as if you were playing a real acoustic piano.

• **INITIAL Touch**

Controls volume and timbre according to the velocity at which you play the keys. The harder you strike the keys, the greater the volume and the brighter the timbre will become. Range: 1 (no Initial Touch effect) – 7 (maximum effect)

• **AFTER Touch**

Controls volume and timbre according to the pressure you apply to the keys after playing them. The harder you press down on the keys, the greater the volume and the brighter the timbre will become. Range: 1 (no After Touch effect) – 7 (maximum effect)

---

**NOTE**

Generally, After Touch has no effect on percussive Voices (such as Piano, Harpsichord, or Vibraphone) or percussion sounds.

---

**2 FEET**

Determines the octave setting of the Voice. PRESET is the original (factory) setting; 4' is the highest and 16' is the lowest.

**3 EFFECT**

Determines the effect type applied to the Voice section. This is essentially an on/off switch for the effects; settings and adjustments to the effects are made from other pages. (For more information, see page 33.)

- PRESET: Selects the original (factory) effect.
- OFF: Cancels the effect.
- TREM. (Tremolo): Selects the Tremolo effect. (See page 39.)
- SYMPH. (Symphonic): Selects the Symphonic/Celeste effect. (See page 37.)
- DELAY: Selects the Delay effect. (See page 38.)
- FLANG. (Flanger): Selects the Flanger effect. (See page 38.)

---

**NOTE**

The actual sound of the effect may not be noticeable even when selected here, if the corresponding settings in the Effect Set page (see page 37) are not appropriate.

---

**4 PAN**

Determines the position of the Voice in the stereo image. Seven Pan positions are available.

---

**NOTE**

The Pan effect is displayed and active only when other effects are set to OFF (in the EFFECT parameter above).

---

**5 BRILL. (Brilliance)**

Determines the timbre or tone of the Voice. Higher settings make the Voice brighter. Range: -3 – +3

---

**NOTE**

These effects are applied in different degrees depending on the type of Voice you've selected.

---

**6 VOLUME**

Fine adjustment of the Voice volume. (See page 16 for more information on Voice volume.) Range: 0 – 24



## VIBRATO Page

Select the Vibrato page by pressing the corresponding Menu button.

The Vibrato page for the Lead Voice section has additional Slide and Tune settings (unlike that of the Upper and Lower sections). The Pedal Voice sections have no Vibrato page.

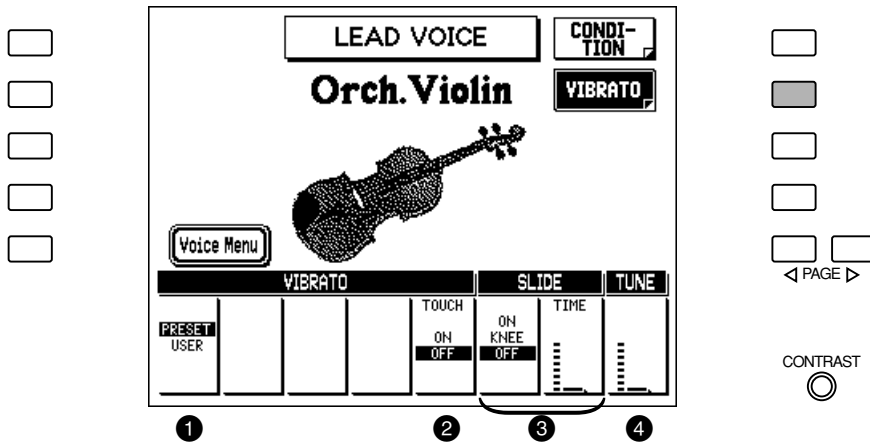

### ① VIBRATO

#### PRESET/USER (See next page for detail on USER VIBRATO.)

Selects Preset, which calls up the original (factory) Vibrato settings for the Voice, or User, which lets you adjust the Vibrato settings yourself.

#### **NOTE**

The Delay, Depth, and Speed settings are not displayed and cannot be adjusted unless USER has been selected in this setting.

### ② TOUCH (Touch Vibrato)

Determines whether Touch Vibrato is on or off. Touch Vibrato lets you apply Vibrato to individual notes as you play them. While playing a key, press down harder on it to give the note Vibrato. The harder you press the key down, the greater the Vibrato will be.

#### **NOTE**

When DEPTH (below) is set to 0, Touch Vibrato is inactive.

### ③ SLIDE (Lead Voices only)

Slide applies a portamento effect to notes played in legato. For example, if you play one note, then play another before completely releasing the first note, the pitch of the first note will “slide” up or down to the second note. The Slide function is effective within a one-octave range.

- **ON/KNEE/OFF**

On/Off switch and knee lever selector for the Slide function.

- **TIME**

Determines the speed of the Slide or portamento effect. The higher the value, the slower the speed.

#### 4 TUNE (Lead Voices only)

Determines the pitch of the Lead Voice. This control lets you detune the Lead Voice relative to the other Voices of the AR-100, for producing a richer sound. The higher the value, the higher the pitch.

#### When Vibrato is set to USER:

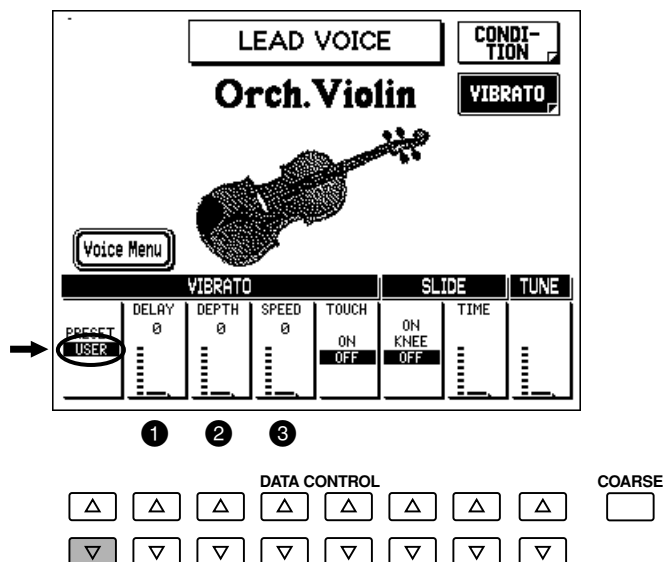

#### 1 DELAY

Determines the amount of time that elapses between the playing of a key and the start of the Vibrato effect (see diagram). Higher settings increase the delay of the Vibrato onset. Range: 0 – 7

#### 2 DEPTH

Determines the intensity of the Vibrato effect (see diagram). Higher settings result in a more pronounced Vibrato. Range: 0 – 7

#### 3 SPEED

Determines the speed of the Vibrato effect (see diagram). Range: 0 – 7

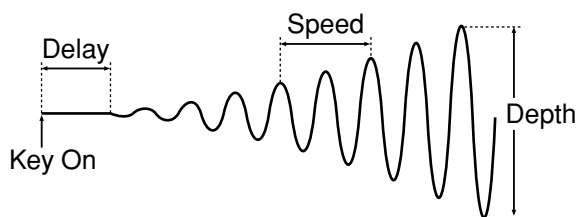

# Effect Set Pages

## Turning On the Effects

Before you can work with the effects in the Effect Set pages, you must first turn on the desired effect in the Voice Condition page.

1. Call up the Voice Condition page by pressing the desired Voice button on the panel twice (or by using any other method; see page 33).
2. Turn on the desired effect for the Voice by using the Data Control buttons below EFFECT in the display. Tremolo / Symphonic, Delay, can Flanger and be selected independently for each Voice section.

## Calling Up the Effect Set pages

Press the EFFECT SET button in the DISPLAY SELECT section, and use the Menu buttons to select the different pages.

### TREMOLO & SYMPHONIC Page

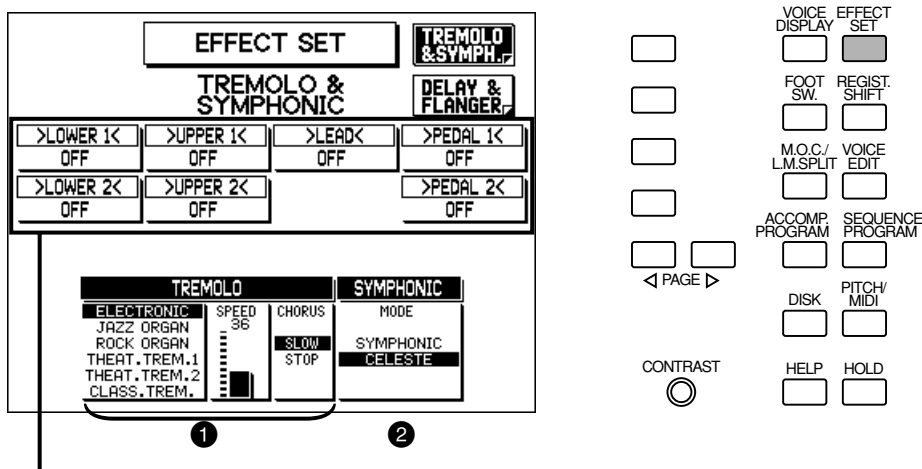

Indicates the effect setting for each Voice section. These cannot be changed here.

#### 1 TREMOLO

(For more information, see the Tremolo section on page 39.)

#### 2 SYMPHONIC

Determines the type of Symphonic effect: Symphonic or Celeste. Symphonic is a subtle effect that makes one Voice sound like an ensemble. For example, a solo violin Voice played through Symphonic would sound like several violins playing together. The SYMPHONIC setting simulates a large ensemble, while CELESTE creates the effect of a gradually expanding sound.

## DELAY & FLANGER Page

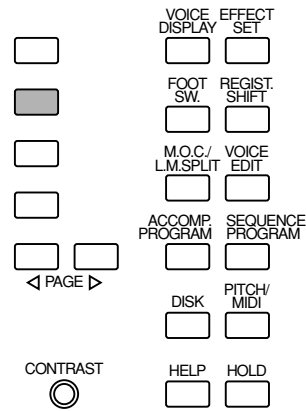
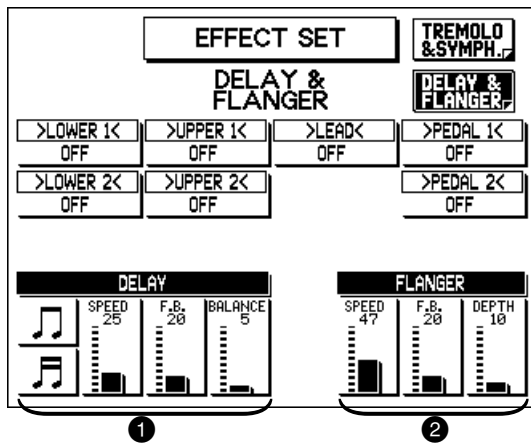

### 1 DELAY

Delay is a pronounced echo effect, with distinct delayed repeats of the original sound.

- **Note Value**

Determines the Delay time as a note value, to ensure that the Delay repeats in sync with the Style tempo. (The eighth-note setting corresponds to a Speed value of 23, while the sixteenth-note corresponds to a value of 61.) Settings: Eighth notes (♪), Sixteenth notes (♪♪)

- **SPEED**

Determines the time between delayed repeats. Higher values result in a shorter Delay time. Range: 0 – 100

- **F.B. (Feedback)**

Determines the number of delayed repeats. Range: 0 – 100

- **BALANCE**

Determines the volume of the Delay effect, relative to the original sound. Higher settings produce a louder delay. Range: 0 – 100

### 2 FLANGER

Flanger introduces a swirling, animated modulation effect to the sound.

- **SPEED**

Determines the speed of the modulation. Range: 0 – 100

- **F.B. (Feedback)**

Controls the brightness and the metallic sound of the effect. Range: 0 – 100

- **DEPTH**

Determines the intensity of the effect. Range: 0 – 100

# Panel-selectable Effects – Tremolo, Sustain, and Reverb

The Reverb, Sustain, and Tremolo pages are called up by pressing the respective panel buttons, then selecting the menu with the bottom left Menu button.

For example, if you press the TREMOLO button (so that the button's lamp lights), the selection "Tremolo Menu" appears at the left of the display:

From this display, use the bottom left Menu button to call up the Tremolo page.

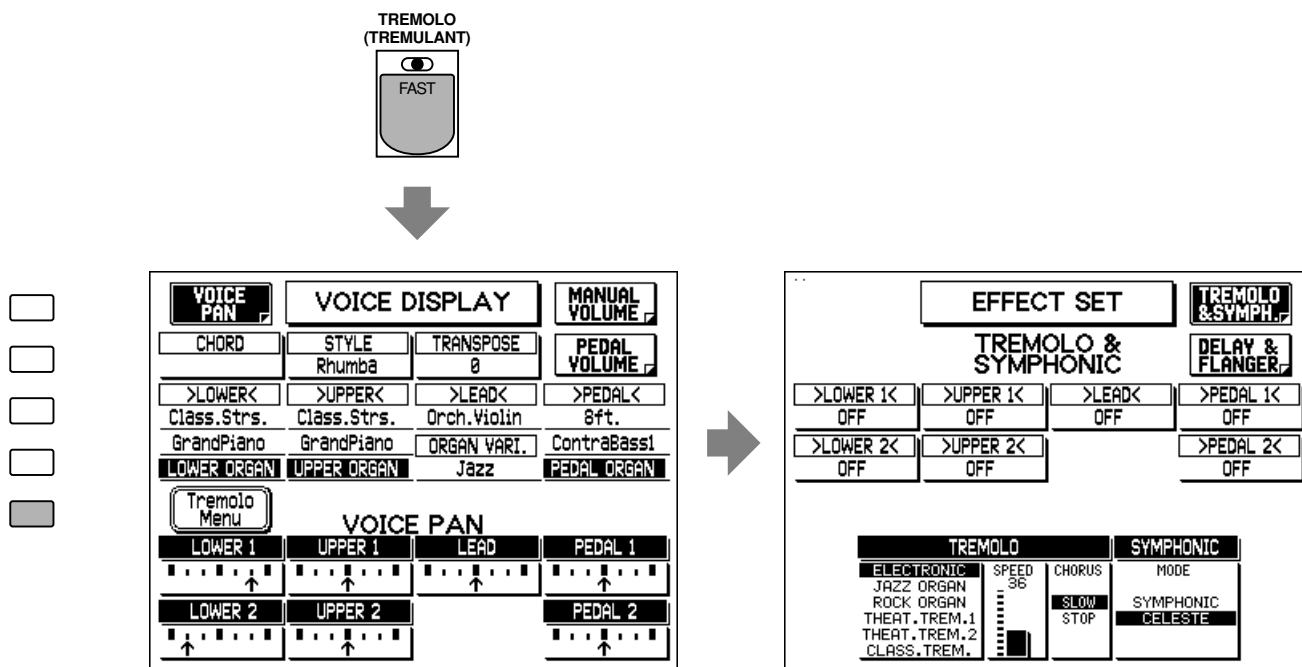

## Tremolo

Tremolo recreates the rich, swirling sound of the popular rotating speaker effect. Just as with a conventional rotating speaker, you can switch between slow and fast speeds. And like a motor-driven speaker, the characteristic tremolo effect gradually changes speed after it is switched. (For ELECTRONIC, JAZZ ORGAN, and ROCK ORGAN only.) You can also choose among different Tremolo types and adjust the maximum speed of the effect to suit your playing style. The Tremolo effect can be switched in real time as you play with either the front panel TREMOLO button or the left footswitch (when properly set for footswitch operation).

### Enabling the Tremolo Effect

Before using Tremolo, it must be enabled (turned on) for the appropriate Voice section in the Voice Condition page. (See page 34) For the Flute/Tibia and Extra Voice sections, Tremolo must be enabled in the FLUTE VOICE and EXTRA VOICE pages, respectively. (See pages 28, 31.)

## Setting the Tremolo Effect

Settings for the Tremolo effect are made from the TREMOLO & SYMPH. (Symphonic) page.

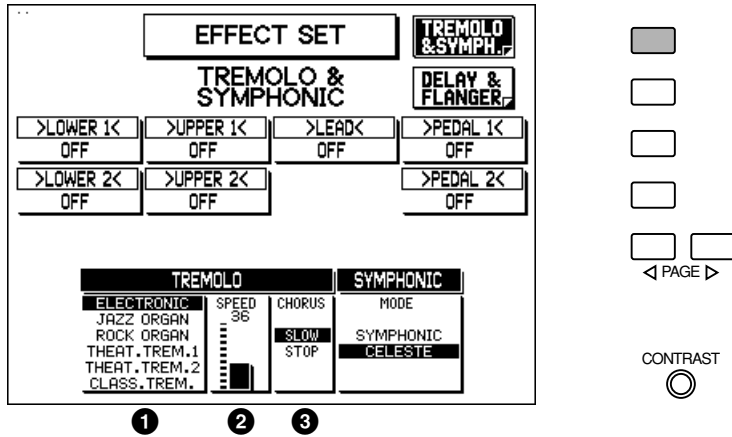

### 1 TREMOLO

Determines the type of Tremolo effect. These types have been programmed to match the corresponding type of organ sounds: Jazz, Rock, Theatre (THEAT.), and Classical (CLASS.).

### 2 TREMOLO SPEED

Determines the speed of the Tremolo (rapid rotation) effect. Range: 0 – 100

### 3 TREMOLO CHORUS

Determines the effect applied when Tremolo is switched off: a slow chorus effect (SLOW) or STOP. Use the SLOW setting when you want to have a constant rotating speaker sound.

## Using the Tremolo Effect

Once the Tremolo effect has been turned on (see “Enabling the Tremolo Effect” above) and set, you can control the effect in real time from the panel or from the left footswitch.

### • Panel Control

Simply press the TREMOLO button to turn the Tremolo effect on and off while you’re playing.

This button functions just like the fast/slow switch on an actual rotating speaker cabinet. When Tremolo is on, the rotation effect is fast; when off (Chorus), it is slow. The speed change is gradual, effectively simulating the slowing down and speeding up of a rotating speaker.

### • Footswitch Control

You can also use one of the footswitches to control the Tremolo effect in the same way, if the footswitch has been properly assigned. (See the section Footswitch Assign on page 156 for details.)

# Reverb

Reverb adds an echo-like effect to the sound, giving the impression of a performance in a large room or concert hall. The effect can be applied equally and simultaneously to all Voices, or set individually for each section of the AR-100, even independently for rhythm, accompaniment and effects.

## To call up the Reverb pages:

**Press the REVERB touch control, then select “Reverb Menu” in the display with the bottom left Menu button. Select the different Reverb pages by using the corresponding Menu buttons.**

## REVERB — GLOBAL Page

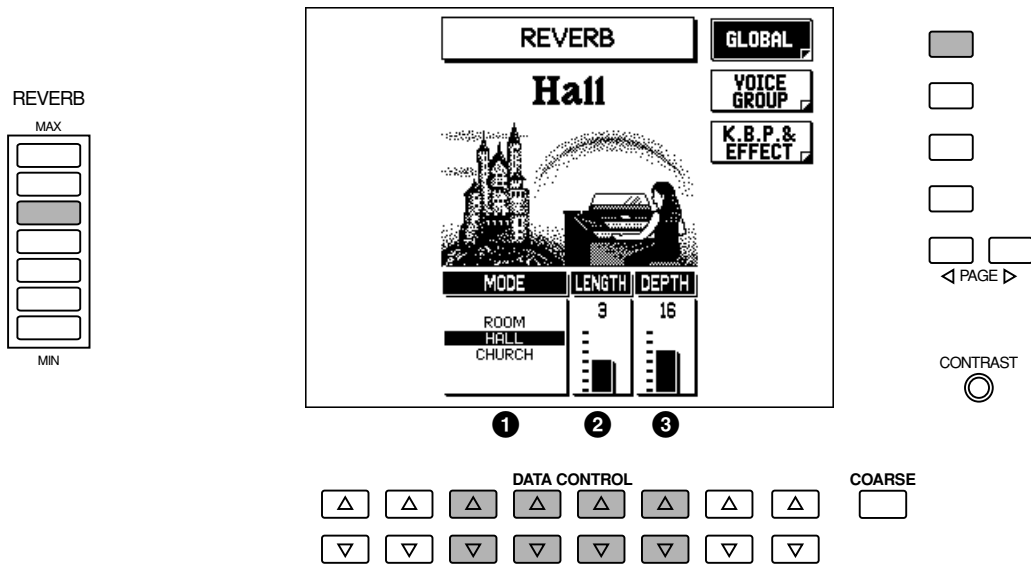

### 1 MODE

Determines the type of Reverb effect: Room, Hall, or Church. Each type simulates a different acoustic environment; Room is the smallest and Church is the largest.

### 2 LENGTH

Determines the acoustic liveliness of the simulated room in the effect. Higher settings make the room more reverberant. Range: 0 – 6

### 3 DEPTH

Fine adjustment of the depth of reverberation or the level of the reflected sounds. (Coarse Reverb depth settings are made with the panel REVERB touch controls.) A setting of 0 effectively turns off the Reverb effect. Range: 0 – 24

### NOTE

When the Depth parameter (or the panel REVERB control) is set to the minimum, the settings in the pages that follow have no effect.

## REVERB — VOICE GROUP Page

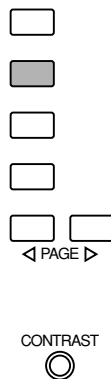
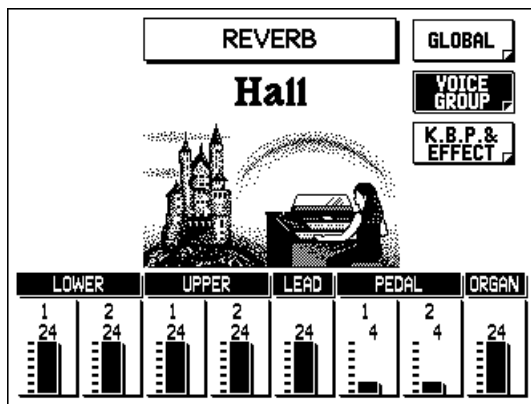

### Voice Section (LOWER 1, 2; UPPER 1, 2; LEAD; PEDAL 1, 2; ORGAN)

Determines the amount of Reverb applied to each of the Voice sections: Lower 1 and 2, Upper 1 and 2, Lead, Pedal 1 and 2, and Organ (Flute/Tibia). Range: 0 – 24

## REVERB — K.B.P. & EFFECT Page

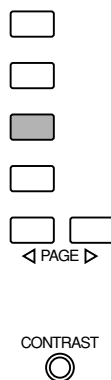
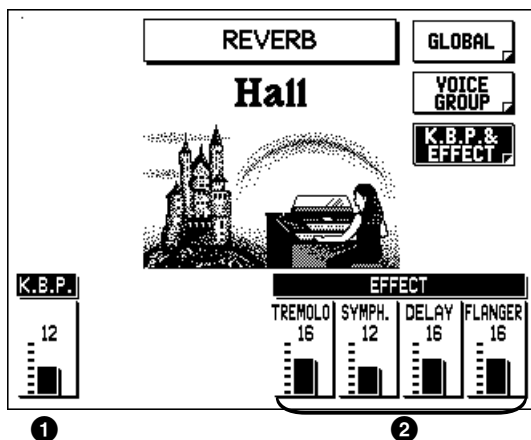

### ① K.B.P. (Keyboard Percussion)

Determines the amount of Reverb effect applied to the Keyboard Percussion sounds. (This does not affect the drum and percussion sounds of the Styles.) Range: 0 – 24

### ② EFFECT [TREMOLLO, SYMPH. (Symphonic), DELAY, FLANGER]

Determines the amount of Reverb applied to the sound of the corresponding effects. Range: 0 – 24



## Sustain

The Sustain effect, selectable for the Upper, Lower, and Pedal Voices, causes the sound to gradually fade out when the keys are released. The Sustain on/off and length settings are independent for each keyboard, providing maximum expressive control. Sustain can be switched on and off in real time as you play, either with the panel SUSTAIN buttons or the knee lever (when properly set for knee lever operation; Upper and Lower keyboards only).

The lamp of each button lights up to indicate that Sustain is on. Press the button again to turn Sustain off.

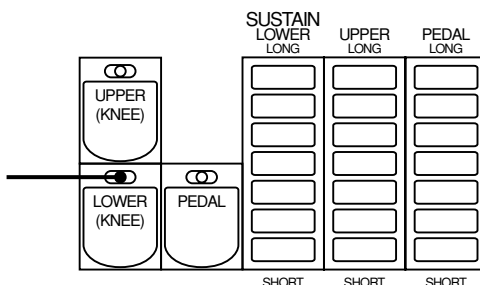

### To call up the Sustain page:

Press any of the buttons or touch controls in the SUSTAIN section, then select "Sustain Menu" in the display with the bottom left Menu button.

### **NOTE**

Sustain cannot be applied to the Lead Voices.

### SUSTAIN Page

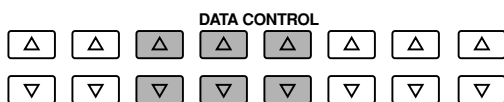
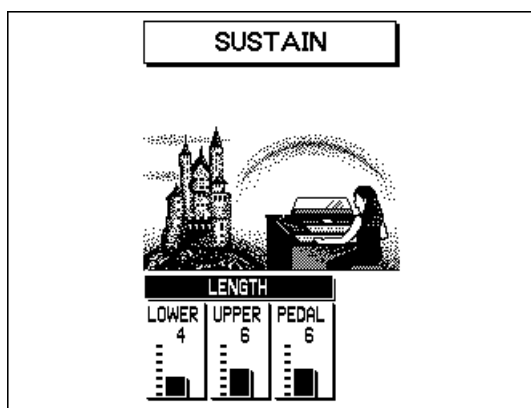

## LENGTH (LOWER, UPPER, PEDAL)

Determines the length of Sustain applied to each keyboard. The display shows the current Sustain length values for each keyboard. (These settings are the same as those made from the panel SUSTAIN touch controls.) Range: 0 – 12

---

### **NOTE**

- The values here must be set high enough for the Sustain effect to be noticeable.
  - Remember that the SUSTAIN buttons are on/off switches. If you use them to simply check the Sustain length values, you may unintentionally change the on/off status of the effect. Remember to check whether the SUSTAIN button lamps are on or off before you start to play.
- 

---

## ***Glide***

---

The Glide effect lets you “bend” the pitch of the various Voice sections by using the left footswitch. When Glide is enabled, pressing the left footswitch lowers the pitch and releasing it brings the pitch back to normal at an adjustable rate.

Glide can be enabled and set in the FOOTSWITCH page. (See page 155.)

# Styles (Rhythm and Accompaniment)

The Style section provides realistic rhythm patterns — with actual drum and percussion sounds — and automatic accompaniment to back your performance. Moreover, the AR-100 has a Keyboard Percussion feature that allows you to play drum and percussion sounds from the Lower keyboard and Pedalboard.

## Selecting and Playing Styles

Ten different Style categories in various styles can be instantly selected from the front panel. The Electone has many more “hidden” Styles, however. A total of 160 Styles are available, and can be selected by using the display.

To select and play a Style:

1. Press one of the ten STYLE buttons (the buttons with names, not numbers).

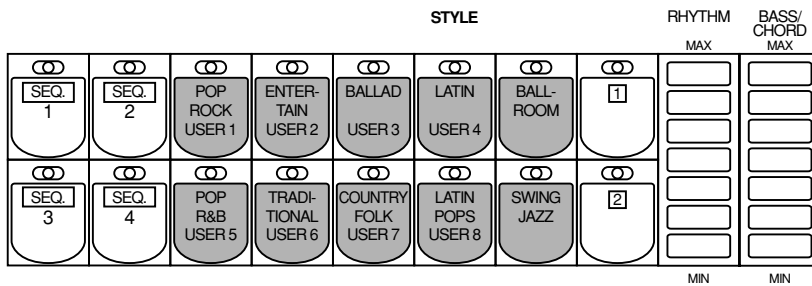

2. Select a specific Style from the Style Menu in the display with the Data Control buttons.

As with the Voice section buttons, each Style button represents a category of Styles, and within each category are 16 variations of the Style. These are shown in the Style Menu, and can be selected with the Data Control buttons.

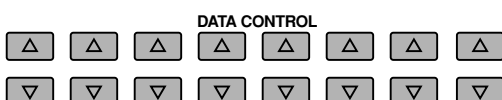
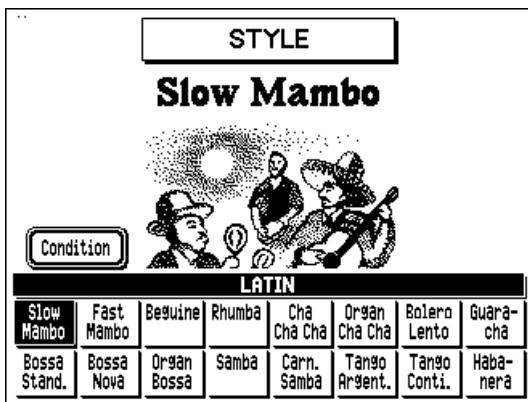

### 3. Before starting the Style, make sure that the Volume and Tempo settings are appropriate.

#### Volume Settings

Use the RHYTHM touch control to adjust the drum/percussion volume, and use the BASS/CHORD touch control to adjust the volume of the bass and chord accompaniment. The controls have seven volume settings, from a minimum of 0, or no sound, to a maximum of full volume. (Both of these settings can also be adjusted from the Style Condition page; see page 51.)

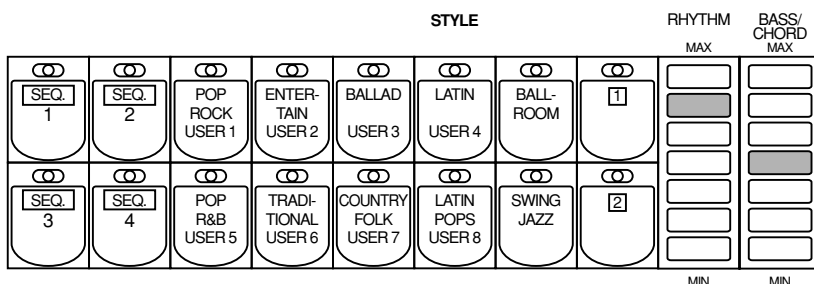

#### Tempo Settings

Use the TEMPO controls to change the tempo (speed) of the Style.



#### TEMPO ▼/▲ controls

These adjust the speed of the Style. Press the TEMPO ▲ button to increase the tempo, and the TEMPO ▼ button to decrease it. To reset the tempo to its preset (default) value, press both buttons simultaneously.

#### TEMPO and BAR/BEAT indicator

This shows the current tempo. (Displayed values are given in beats per minute, just as on a conventional metronome.) The tempo range is 40 to 240 beats per minute.

While the Style is playing, the TEMPO display changes function to a BAR/BEAT indicator.

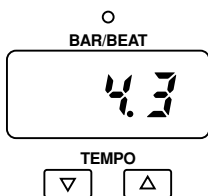

The number on the left indicates the current bar or measure and the one on the right indicates the number of the beat in each bar. The beat indicator lamp above the display also flashes at the first beat of every measure while a Style is playing. When a Style is in stand-by (after pressing SYNCHRO START, or after pausing the Style with the left footswitch, for example), the lamp flashes at every beat, to visually indicate the tempo.

#### **NOTE**

When you adjust the tempo while the Style is playing, the display momentarily changes to show the current tempo.

## 4. Start the Accompaniment.

You can start the Accompaniment in several different ways from the ACCOMPANIMENT CONTROL buttons:

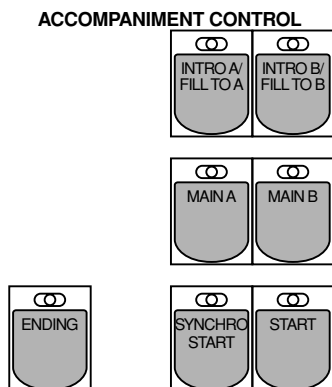

### **Straight Start:**

Select the desired Style section, Main A or Main B (by pressing the appropriate button, MAIN A or MAIN B), then press the START button. The Main A (or B) begins playing immediately without bass and chord accompaniment. To stop the Accompaniment, press START again.

### **Start with an introduction, followed by one of the MAIN patterns:**

Each Style has two Intro variations, as well as Main. Press the INTRO A (or INTRO B) button, then press START. The Intro A (or B) Style plays and is followed by the corresponding Main pattern. To stop the Accompaniment, press START again.

Pressing the ENDING button while the pattern is being played will automatically add an ending phrase before stopping the Accompaniment.

### **Synchro Start:**

Any of the above start types can be synchronized to the first note you play on the Lower keyboard or Pedalboard.

## To use Synchro Start:

- First, press the SYNCHRO START button. This puts the Style in stand-by. (The BAR/BEAT indicator above the TEMPO display flashes at the current tempo.)



- Next, play a note or chord on the Lower keyboard (or a note on the Pedalboard). This starts the Rhythm and the bass/chord Accompaniment. To stop the Accompaniment, press SYNCHRO START again.

### ***About Automatic Accompaniment and Playing Chords***

*One of the main advantages of the Styles is that they can be used to create automatic backing parts (accompaniment) for your performance. This accompaniment changes to match the chords you play on the Lower keyboard. Also, when you play a chord, the chord root and type are automatically shown in the display (when Voice Display is selected). For more information on automatic accompaniment and chord recognition, see page 55.*

#### **HINT**

**About footswitch control:**  
The left footswitch can also be used to turn the Accompaniment on and off functioning as a start/stop switch for the Style. (To assign the footswitch for Style control, see page 154.)

#### **NOTE**

Depending on the A.B.C. mode and the Memory setting, the Accompaniment may stop when you release keys on the Lower keyboard or Pedalboard. (Refer to page 60 for details on Auto Bass Chord and Memory.)

## 5. Select Sections, if desired.

You can switch between the two Style Sections, Main A and Main B, as the Accompaniment is playing by pressing the appropriate button, MAIN A or MAIN B.

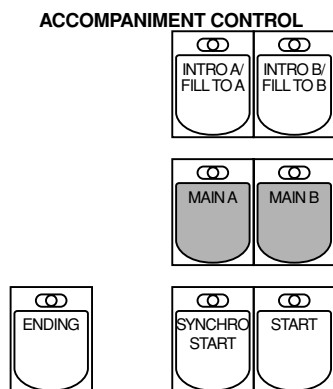

## 6. Select Fill In patterns, if desired.

Fill In patterns are designed to be used as temporary and regular rhythmic breaks, to add interest to a repeating rhythm. Like all the other patterns, the Fill In patterns have been designed to match the bass and chord parts of the selected Style, as well as lead perfectly into the corresponding section.

You can select these patterns as the Style is playing by pressing the appropriate button, INTRO A/FILL TO A or INTRO B/FILL TO B. For best results, press the button just at the beginning (or the first beat) of a measure.

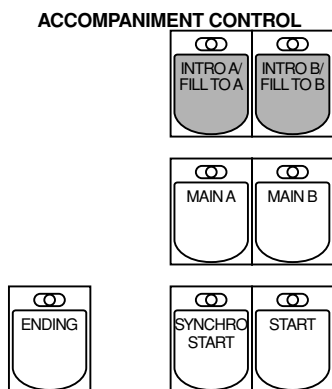

### HINT

**Playing partial Fill In patterns:**  
You can also start Fill In patterns within a bar, in order to play only the final one or two beats of the Fill In pattern and create additional rhythmic interest. Since the Fill In feature is very sensitive to bar/beat boundaries, you should be very careful to "play" the FILL IN button precisely on (or just slightly before) the beat that you want the Fill In pattern to begin.

## About the Style Sections

Each Style has a total of ten sections, as illustrated below.

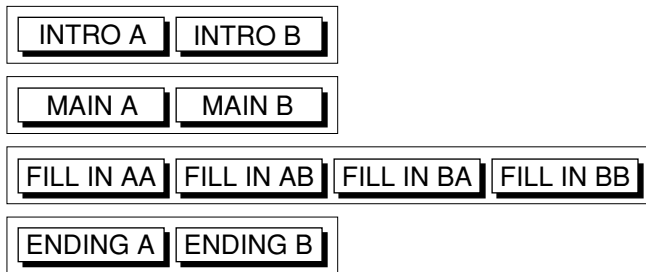

The FILL TO A button plays a one-measure Fill In and goes to the Main A pattern. The FILL TO B button plays a one-measure Fill In and goes to the Main B pattern. However, you can change the pattern to be played by pressing the appropriate button (MAIN A or MAIN B) while the Fill In is playing.

There are actually four separate Fill In patterns, each one measure in length: AA, AB, BA, and BB. These correspond to the patterns (Main A and B) that precede and follow the Fill In.

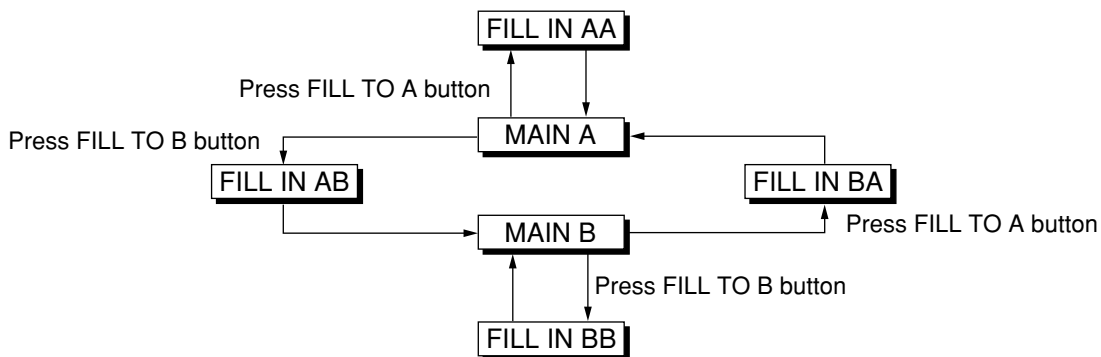

## 7. Stop the Accompaniment.

Press the ENDING button while the Accompaniment is playing. This automatically plays a short ending phrase before stopping the Accompaniment. There are two ending patterns, Ending A and B, which correspond to the Main A and B patterns.

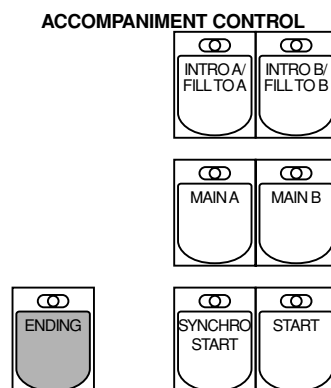

You can also stop the Accompaniment without playing an Ending pattern by pressing the same button that you used to start the Accompaniment (START or SYNCHRO START).



## Style Condition Page

The Style Condition page provides fine controls over Rhythm volume and Bass/Chord volume and allows you to turn each accompaniment part on or off.

To call up the page, press the selected Style button (or appropriate Data Control button) again, or select CONDITION from the display with the appropriate Menu button (from the Style Menu page). Adjust the settings with the appropriate Data Control buttons.

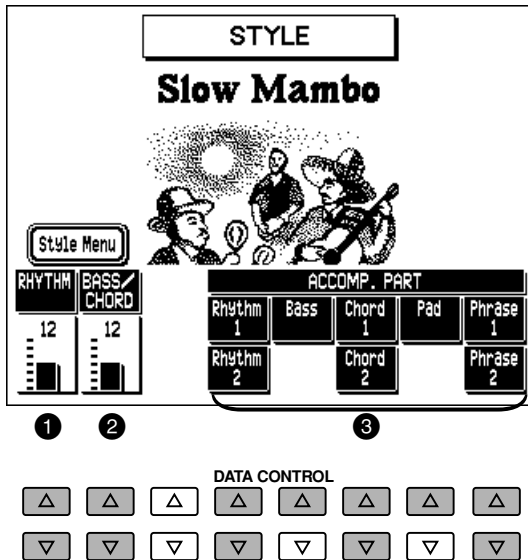

### ① RHYTHM

Fine control of the drum/percussion volume. Range: 0 – 24

### ② BASS/CHORD

Fine control of the bass and chord accompaniment volume. Range: 0 – 24

### ③ ACCOMP. (Accompaniment) PART

For turning on/off specific parts of the accompaniment: Rhythm 1 & 2, Bass, Chord 1 & 2, Pad, Phrase 1 & 2.

# Selecting Styles from the Dotted Buttons

The Style section, like the Voice sections, also has dotted buttons from which additional Styles can be selected. These dotted buttons function as “wild card” Style selectors; any of the Styles available from the panel buttons, Style Menus, or User Styles (created with the Accompaniment Program function) can be selected from these buttons.

**NOTE**

As with the Voice sections’ dotted buttons, you can set two or three Styles from the same page to be selected from different buttons (one from the original Style button, and the others from the two dotted buttons).

To select Styles from the dotted buttons:

1. Press one of the dotted buttons in the Style section.

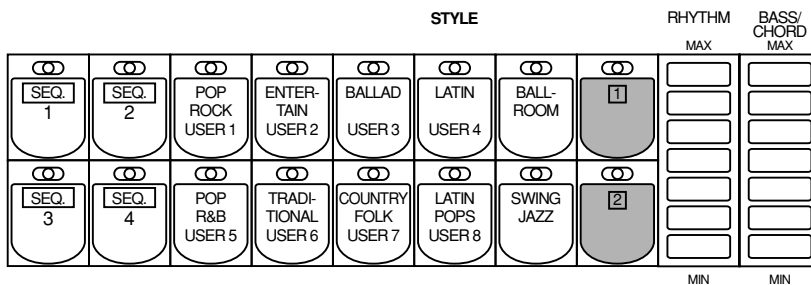

2. Scroll through the various categories with the PAGE buttons.

### 3. Select a specific Style Menu by pressing corresponding Menu button.

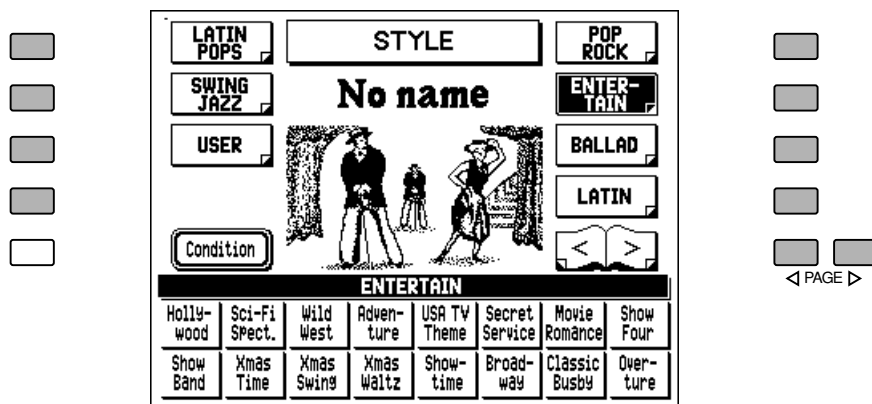

Each page represents a general Style category and the category title appears in the dark bar at the top of the menu when the menu has been selected.

#### **NOTE**

The Style name at the top of the display is that of the currently assigned Style and is unrelated to the Style menu at the bottom.

### 4. Select a specific Style from the display by using the Data Control buttons.

The name of the selected Style appears at the top of the display.

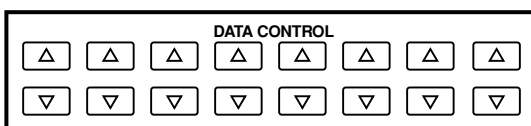
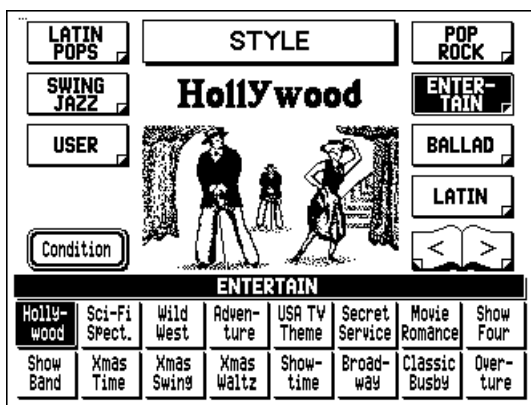

Use the Data Control buttons to select a Style.

#### **HINT**

You can directly view and select Style Menu pages by holding down one of the dotted buttons and simultaneously pressing the desired Style buttons in succession.

## To select User Styles:

Select the USER Style Menu (by the same method above) when you wish to play Styles that you've created in the Accompaniment Program function (see page 122).

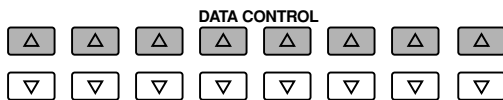
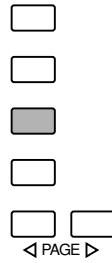
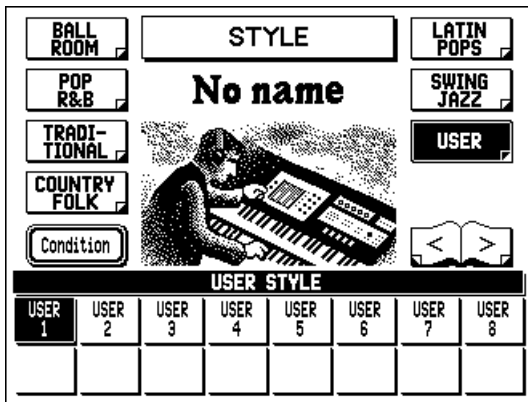

## Style Menus / Style List

Page 1

Pop / Rock							
Pop Rock	Light Rock	Rock Ballad	Heavy Rock	Boogie	Twist	Rockabilly	Slow Rock
Rock & Roll 1	Rock & Roll 2	Euro-beat	Disco Tropic.	Disco	70's Disco	Disco Pop	Folk Rock

Page 2

Entertainment							
Hollywood	Sci-Fi Spect.	Wild West	Adventure	USA TV Theme	Secret Service	Movie Romance	Show Four
Show Band	Xmas Time	Xmas Swing	Xmas Waltz	Show-time	Broadway	Classic Busby	Overture

Page 3

Ballad							
8 Beat	8 Beat Slow	16Beat 1	16Beat 2	Slow Ballad	Epic Ballad	Piano Ballad	6/8 Ballad 1
6/8 Ballad 2	Folk Ballad	Fusion Ballad	16Beat Ballad1	16Beat Ballad2	8Beat Ballad1	8Beat Ballad2	4Beat Ballad

Page 4

Latin							
Slow Mambo	Fast Mambo	Beguine	Rhumba	Cha Cha Cha	Organ Cha Cha	Bolero Lento	Guaracha
Bossa Stand.	Bossa Nova	Organ Bossa	Samba	Carn. Samba	Tango Argent.	Tango Conti.	Habenera

Page 5

Ballroom							
Jive	Conti. Foxtrot	Slow Foxtrot	Orchst. Foxtrot	BigBand Foxtrot	Modern Waltz	St. Bern. Waltz	BigBand Waltz
Gentle Waltz	Organ Q.step	Theatre Q.step	BigBand Q.step	6/8 2 Step	Barn Dance	Paso. 4/4	Paso. 3/4

Page 6

Pop / R&B							
R & B	Gospel	Gospel Waltz	6/8 Blues	Funk	Soul	16Beat Pop	16Beat Shuffle
New Age	Organ Rock	Guitar Pop	Rock Pop	Light Pop	8Beat Light	8Beat Fast	Pop Shuffle

Page 7

Traditional							
4/4 March	Milit. March	6/8 March	Blues March	Symph. March	Strauss March	Trad. Waltz 1	Trad. Waltz 2
Swing Waltz	Vienna Waltz	Slow Waltz	Polka 1	Polka 2	Polka Pop	German March	Bolero

Page 8

Country / Folk							
Blue Grass	Two Step	Cowboy Bounce	Country Shuffle	Country Ballad	Horse Walkin'	Country Waltz 1	Country Waltz 2
Country Rock 1	Country Rock 2	Andes	Cowboy	Chanson	Espagnole	Scot. Dance	Tarantella

Page 9

Latin Pops							
Latin Rock	Pop Bossa	Bossa Rock	Pop Samba	Pop Rhumba	Latin Pop	Party Pop 1	Party Pop 2
Reggae 12	Reggae 16	Pop Reggae	Bamba Party	Salsa	Meren-gue	Calypso	Son

Page 10

Swing / Jazz							
City Swing	Swing Seren.	BigBand Fast	BigBand Medium	Ragtime	Dixie-land	Charles-ton	Double Swing
Afro Cuban	Hot Jazz	Jazz Ballad 1	Jazz Ballad 2	Organ Swing	Jazz Rock	Jazz Waltz	5/4

# Automatic Accompaniment – Auto Bass Chord

The Auto Bass Chord (A.B.C.) function works with the Style section of the AR-100 to automatically produce chord and bass accompaniment as you play. It adds an entirely new dimension to your performance by effectively putting a full backing band at your disposal. Depending on the feature or mode selected, you can play anything from a single note to a full chord on the Lower keyboard and hear complete, rhythmical bass and chord accompaniment.

## Setting the A.B.C. Mode

There are three Auto Bass Chord modes: Single Finger, Fingered Chord, and Custom A.B.C.

### To set and use A.B.C.:

**Press the appropriate mode button in the AUTO BASS CHORD section: SINGLE FINGER, FINGERED CHORD, or CUSTOM A.B.C.**

The selected button lights, and the “A.B.C. Menu” selection appears in the display. (Selecting the “A.B.C. Menu” is optional; pressing the panel button changes the mode.)

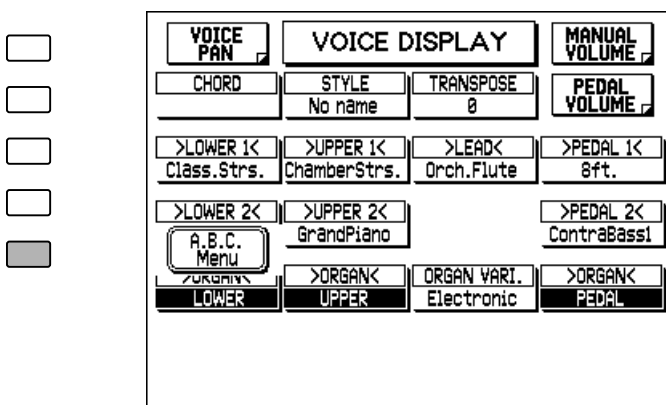
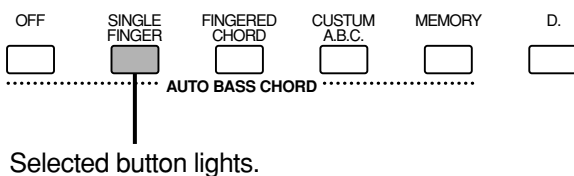

### **NOTE**

The Voice Display is shown above; however, the “A.B.C. Menu” selection will appear in whatever display is currently selected.

Selecting "A.B.C. Menu" calls up the following display, from which you can make A.B.C. settings:

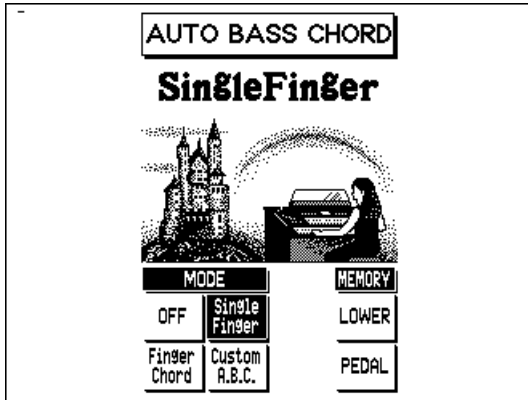

## **Mode**

### **Off**

The Off mode automatically produces chord accompaniment for chords played in the Lower keyboard. (Bass lines are not produced; you can play bass lines manually from the Pedalboard.) This mode is similar to the Custom A.B.C. mode in that you play all the notes of the chord while the Auto Bass Chord function automatically selects the appropriate chord patterns. (Refer to the Fingered Mode Chords chart on page 58.)

### **Single Finger mode**

The Single Finger mode provides the fastest and easiest means to obtain many different chord/bass combinations, by simply using one, or at most, two or three fingers to play the chords. (Refer to the Single Finger Mode Chords chart on page 57.) When this is selected, Pedal Voices cannot be played from the Pedalboard (regardless of the volume setting).

### **Fingered Chord mode**

The Fingered Chord mode automatically produces bass and chord accompaniment for chords played in the Lower keyboard. It allows you to use a wider range of chord types than in the Single Finger mode. In the Fingered Chord mode, you play all the notes of the chord while the Auto Bass Chord function automatically selects the appropriate bass and chord patterns. (Refer to the Fingered Mode Chords chart on page 58.) When this is selected, Pedal Voices cannot be played from the Pedalboard (regardless of the volume setting).

### **Custom A.B.C.**

This is similar to Fingered Chord above (and uses the same chord indications), except that it lets you determine the bass notes of the A.B.C. accompaniment by playing a note on the Pedalboard, along with the chords you play in the Lower keyboard. The Custom A.B.C. mode automatically produces a bass line based on the note you play on the Pedalboard.

## Single Finger Mode Chords

**C**



**Major chords:**

Press the root note of the chord.

**C7**



**7th chords:**

Press the root note together with any white key to the left of it.

**Cm**



**Minor chords:**

Press the root note together with any black key to the left of it.

**Cm7**



**Minor 7th chord:**

Press the root note together with any white and black key to the left of it (three keys altogether).

## Chord Cancel

Chord Cancel allows you to instantly turn off the chord and bass accompaniment, and have the rhythm pattern continue. This lets you create dynamic rhythm “breaks” in your performance. (Chord Cancel cannot be used in the Single Finger mode.)

### To use Chord Cancel:

While the A.B.C. accompaniment is playing, simultaneously press three adjacent keys in the Lower keyboard.



“Chord Cancel” appears in the display, and the rhythm of the Style plays without chord or bass accompaniment. To resume bass/chord accompaniment, play conventional chords.

# Fingered Mode Chords

- Notes in parentheses ( ) can be omitted.
- Chord types marked with an asterisk (\*) can be played in any inversion (i.e. the root does not have to be the lowest note in the chord).
- If you play any three adjacent keys (including black keys), the chord sound will be canceled and only the rhythm instruments will continue playing (CHORD CANCEL function).
- Please determine which chords you are going to use before playing a song. In the case of chords marked with a “ • ” it may be necessary to shift the split to allow easy fingering.

<b>Major*</b> C	<b>Minor*</b> Cm	<b>Seventh*</b> C7	<b>Minor seventh</b> Cm7
<b>Major seventh flatted fifth</b> Cm7(b5)	<b>Sixth</b> C6	<b>Minor sixth</b> Cm6	<b>Major seventh*</b> CM7
<b>Suspended fourth</b> Csus4	<b>Augmented</b> Caug	<b>Diminished*</b> Cdim	<b>Seventh suspended fourth</b> C7sus4
<b>Diminished seventh</b> Cdim7	<b>Seventh flatted fifth</b> C7(b5)	<b>Minor major seventh*</b> CmM7	<b>Seventh augmented*</b> C7aug
<b>Seventh ninth*</b> C7(9)	<b>Minor added ninth*</b> Cm(9)	<b>Minor seventh ninth*</b> Cm7(9)	<b>Major seventh sharp eleventh*</b> CM7(#11)
<b>Added ninth*</b> Cadd9	<b>Major seventh ninth*</b> CM7(9)	<b>Six ninth</b> C6(9)	<b>Minor seventh eleventh</b> Cm7(11)
<b>Minor major seventh ninth*</b> CmM7(9)	<b>Seventh sharp eleventh*</b> C7(#11)	<b>Seventh added thirteenth*</b> C7(13)	<b>Seventh flatted ninth*</b> C7(b9)
<b>Seventh added flatted thirteenth*</b> C7(b13)	<b>Seventh sharp ninth*</b> C7(#9)	<b>Major seventh augmented*</b> CM7aug	<b>One plus two plus five</b> C1+2+5
<b>Major seventh flatted fifth*</b> CM7(b5)	<b>Flatted fifth*</b> C(b5)	<b>Minor major seventh flatted fifth*</b> CmM7(b5)	



## Memory

Memory allows you to have the bass and/or chord accompaniment continue even after you release your fingers from the Lower keyboard and/or Pedalboard.

For more information on the Memory settings and how they function with the different A.B.C. modes, refer to the chart on page 60.

### **Press the MEMORY button in the AUTO BASS CHORD section to turn Memory on (both Lower and Pedal).**

When the button is lit, Memory is on for both Lower and Pedal. In other words, both the bass and chord accompaniment continue even after you release your fingers from the Lower keyboard and/or Pedalboard.

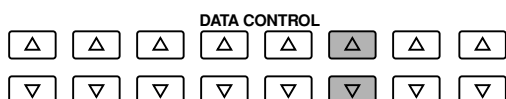
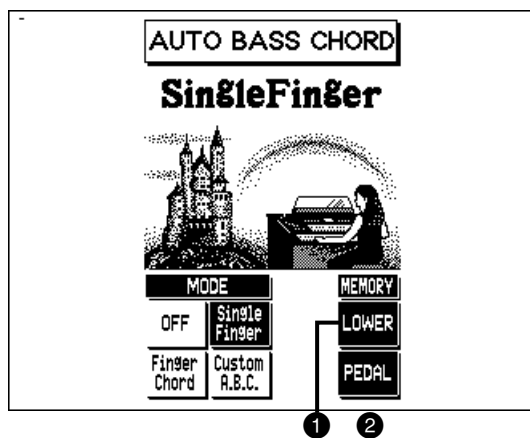
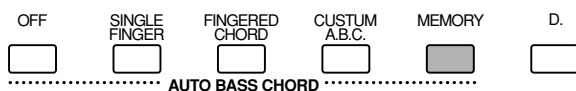

If you wish, you can set Lower Memory and Pedal Memory independently from the display. To do this, select LOWER or PEDAL with the appropriate Data Control buttons. (When set to on, the corresponding box is highlighted.)

#### **1 LOWER**

Selecting this keeps the chord accompaniment playing even after you release your fingers from the Lower keyboard.

#### **2 PEDAL**

Depending on the A.B.C. mode selected, this keeps the bass or bass accompaniment playing even after you release your fingers from the Lower keyboard (or your foot from the Pedalboard). (See chart on page 60 for details.)

## About the A.B.C. Modes and Memory Settings

The automatic accompaniment functions in different ways depending on the selected A.B.C. mode and the Memory setting. The chart below details how the automatic accompaniment functions for the various setting combinations when Synchro Start is on. When the START button is used, the functions are the same, except that the rhythm is started and stopped only with the START button or the left footswitch (when enabled; see page 154).

A.B.C. Mode	Accompaniment	Memory Setting		Comments
		Lower	Pedal	
Off	Chord accompaniment only; no bass accompaniment (use Pedalboard to play bass notes).	OFF	OFF	When Lower keys are released, chord accompaniment stops but rhythm continues.
		ON	OFF	When Lower keys are released, chord accompaniment and rhythm continue.
		OFF	ON	When Lower keys are released, chord accompaniment stops and rhythm continues; played pedal notes are held.
		ON	ON	When Lower keys are released, chord accompaniment and rhythm continue; played pedal notes are held.
Fingered Chord	Full chord and bass accompaniment by playing Lower keyboard; playing Pedalboard has no effect.	OFF	OFF	When Lower keys are released, accompaniment and rhythm stop. (When START LED is on, only the rhythm continues.)
		ON	OFF	When Lower keys are released, only bass accompaniment stops.
		OFF	ON	When Lower keys are released, only chord accompaniment stops.
		ON	ON	When Lower keys are released, accompaniment and rhythm continue.
Single Finger	Full chord and bass accompaniment by playing Single Finger chords on Lower keyboard (see page 57); playing Pedalboard has no effect.	OFF	OFF	When Lower keys are released, accompaniment and rhythm stop. (When START LED is on, only the rhythm continues.)
		ON	OFF	When Lower keys are released, only bass accompaniment stops.
		OFF	ON	When Lower keys are released, only chord accompaniment stops.
		ON	ON	When Lower keys are released, accompaniment and rhythm continue.
Custom	Chord accompaniment by playing Lower keyboard; bass accompaniment by playing Pedalboard.	OFF	OFF	When both the Lower keys and pedals are released, the accompaniment and rhythm stop. (When START LED is on, only the rhythm continues.)
		ON	OFF	When pedals are released, only bass accompaniment stops.
		OFF	ON	When Lower keys are released, only chord accompaniment stops.
		ON	ON	Bass and chord accompaniment continue when Lower keys and/or Pedalboard are released.

## ***Disabling Accompaniment Changes (Disable)***

This function allows you to maintain the same Style and its tempo, even when you change Registrations. To do this, press the D. (Disable) button in the AUTO BASS CHORD section (or the D. button in the Registration Memory section). (Both buttons light.)

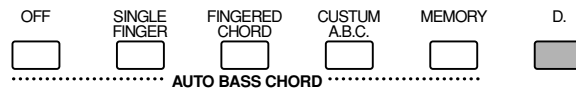

## ***Keyboard Percussion***

The Keyboard Percussion function features a total of 72 different drum and percussion sounds, playable from the keyboards and Pedalboard.

Keyboard Percussion has two different modes, Preset and User. Preset Keyboard Percussion lets you play 49 different sounds from the Lower keyboard and Pedalboard, while the User Keyboard Percussion lets you freely assign the 72 available sounds to any key or pedal you wish.

The two Keyboard Percussion buttons on the panel function as on/off switches for both Keyboard Percussion modes.

### **To use the Preset Keyboard Percussion:**

- 1. Turn on the Keyboard Percussion function by pressing the LOWER and/or PEDAL buttons in the KEYBOARD PERCUSSION section on the left side of the panel.**

Pressing the LOWER button (the lamp lights) calls up the following display.

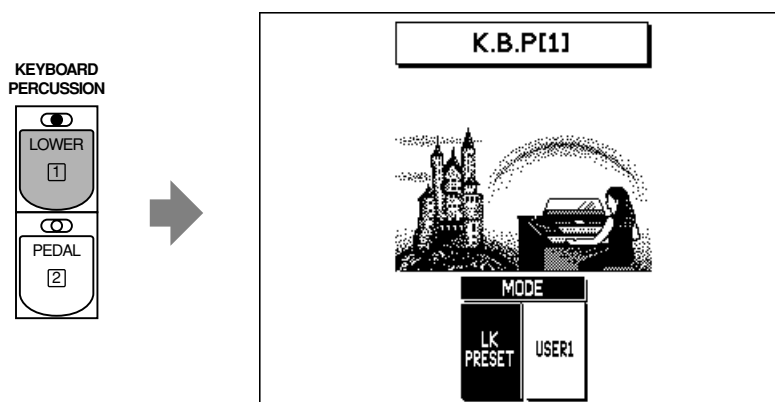

### **NOTE**

Pressing one of the KEYBOARD PERCUSSION buttons calls up the Mode display shown at the left. If the User Mode is currently active, select "LK/PK PRESET" (Lower Keyboard/Pedalboard Preset).

Do the same for the Pedal Keyboard Percussion, if desired.

## 2. Set the volume.

The volume of the percussion sounds is set together with that of the rhythm volume from the RHYTHM touch control.

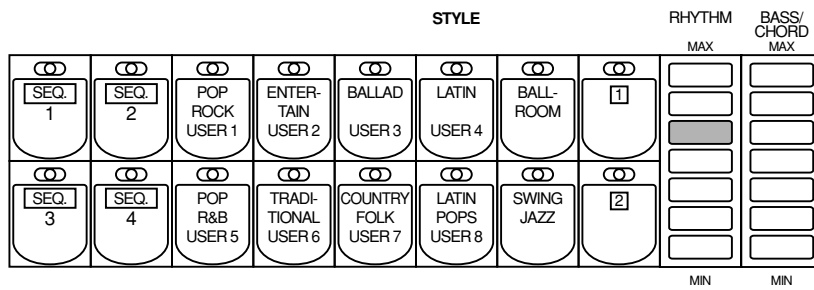

## 3. Turn off the Lower and/or Pedal Voices by turning each Voice section off in the ENSEMBLE section.

## 4. Play some notes on the Lower keyboard and Pedalboard.

The 49 percussion sounds have been assigned to the keyboards as shown in the chart.

## **Preset Percussion Assignments for the Lower Keyboard**

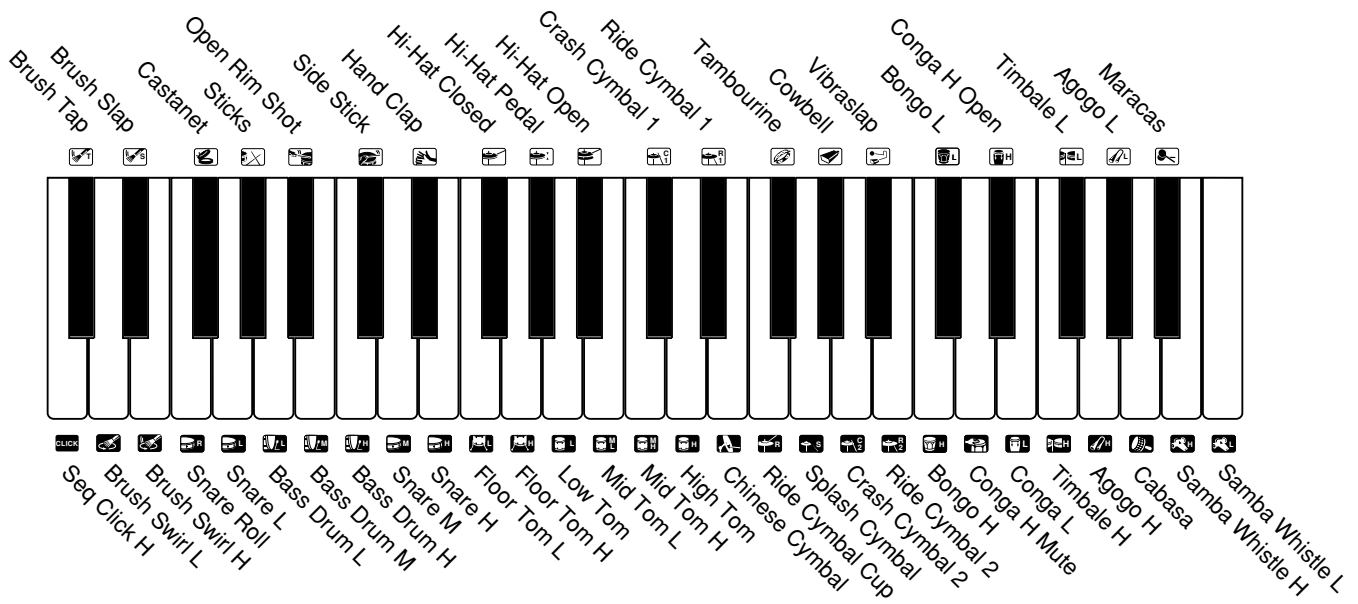

## **Preset Percussion Assignments for the Pedalboard**

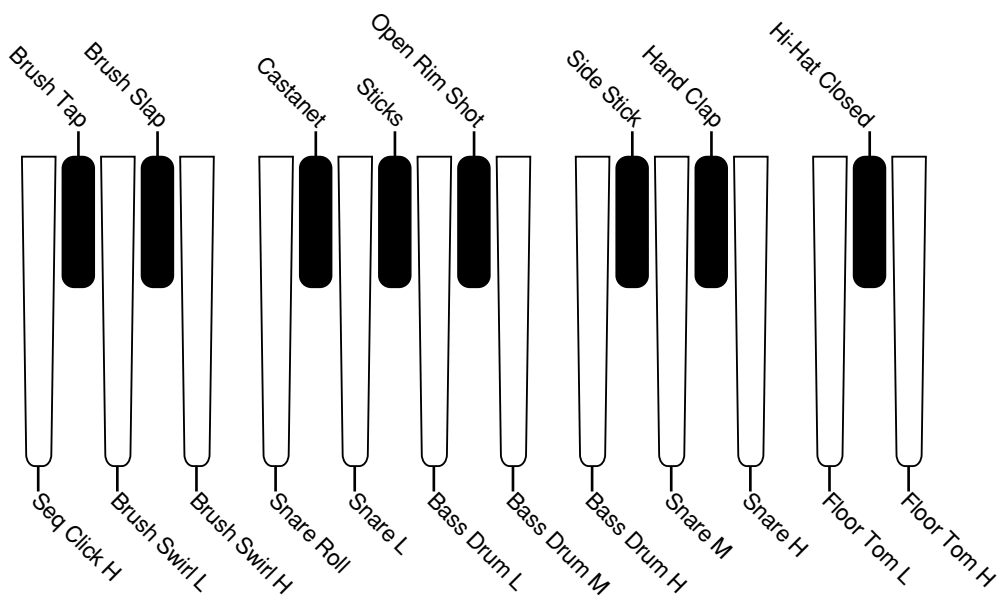

## **User Keyboard Percussion**

A total of 72 different percussion sounds can be assigned to any key or pedal, and your original setups can be saved to two memory locations: User 1 and User 2. (For this example, use User1.)

### **To create your own Keyboard Percussion assignments:**

#### **1. Turn on the Keyboard Percussion function by pressing the LOWER/1 button in the KEYBOARD PERCUSSION section.**

The numbers "1" and "2" on the LOWER and PEDAL buttons refer to User 1 and User 2, respectively.

### **Keyboard Percussion Mode Page**

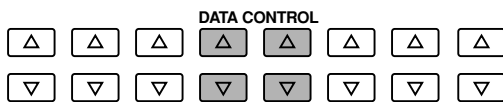
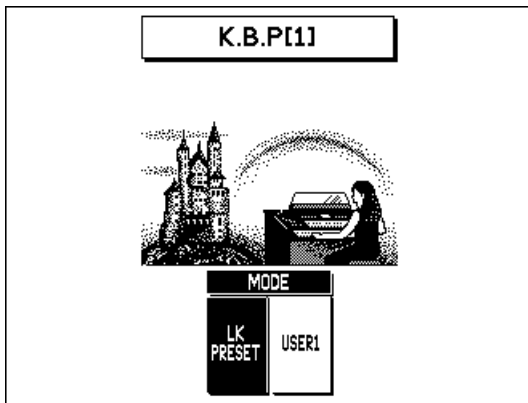

In the display above, the LK Preset is currently selected. The Mode can be changed between LK (Lower Keyboard) PRESET and USER 1.

### **When the PEDAL/2 button is used to call up the Mode display:**

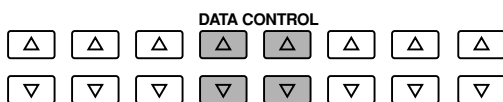
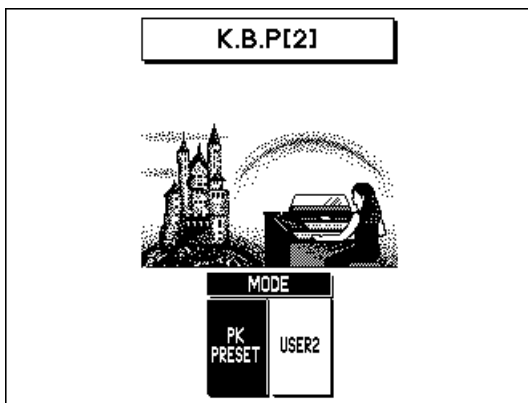

Here, the Mode can be changed between PK (Pedal Keyboard) PRESET and USER 2.

**2. Select the User mode with the appropriate Data Control button.**

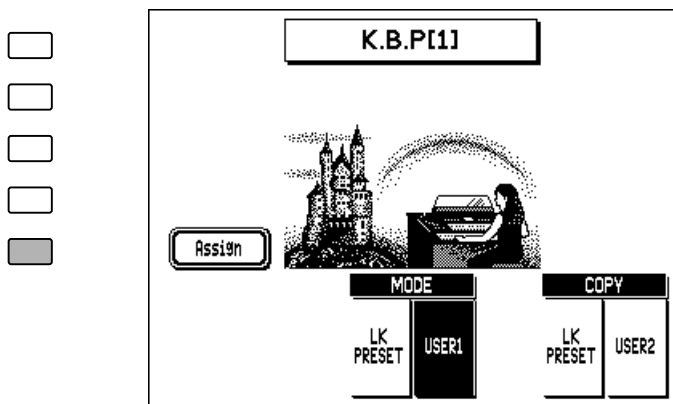

**3. Select the ASSIGN page by pressing the appropriate Menu button.**

**ASSIGN Page**

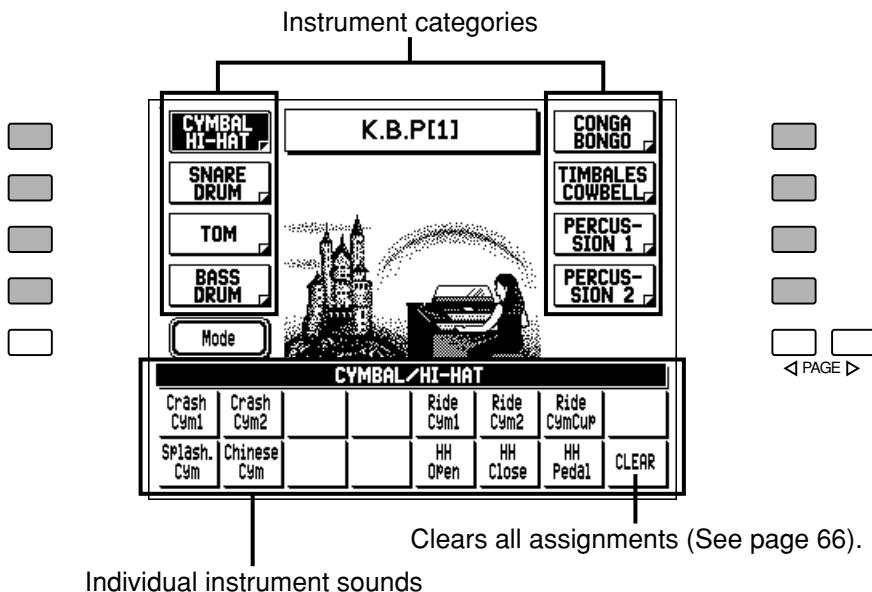

Individual instrument sounds  
Clears all assignments (See page 66).

**4. Select the desired instrument category (Cymbal/Hi-Hat, Snare Drum, etc.) by pressing the appropriate Menu button.**

**5. To assign an instrument to a particular key or pedal, simultaneously hold down the Data Control button corresponding to the desired instrument and press the upper/lower key (or pedal) to which the instrument is to be assigned.**

Continue assigning additional sounds to the other keys as required.

## **Clear**

The Clear function lets you erase one or all instrument/key assignments.

### **To erase a single instrument assignment:**

**Simultaneously hold down the Data Control button corresponding to CLEAR and press the key or pedal corresponding to the instrument you wish to erase.**

A short click sound indicates that the instrument has been erased.

### **To erase all instrument assignments:**

- 1. Press the Data Control button corresponding to CLEAR in the display (see step #3 above).**

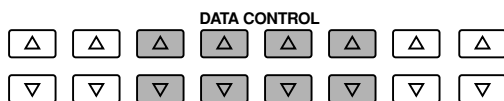
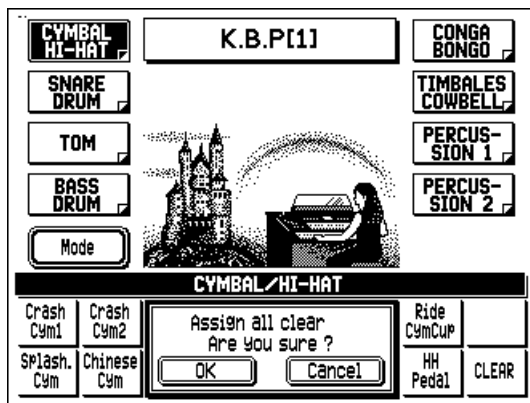

- 2. At the prompt, select "OK" (with the appropriate Data Control buttons) to erase all assignments, or "Cancel" to abort the operation.**



## **User Keyboard Percussion Categories**

CYMBAL / HI-HAT							
Crash Cym1	Crash Cym2			Ride Cym1	Ride Cym2	Ride CymCup	
Splash. Cym	Chinese Cym			HH Open	HH Close	HH Pedal	CLEAR

SNARE DRUM							
Snare Drum L	Snare Drum M	Snare Drum H		Brush Tap	Brush Swirl L	Brush Slap	Brush Swirl H
SD Roll	O Rim Shot			Sticks	Side Stick		CLEAR

TOM							
Floor Tom L	Floor Tom H	Low Tom	Mid Tom L	Mid Tom H	High Tom		
							CLEAR

BASS DRUM							
Bass Drum L	Bass Drum M	Bass Drum H					
							CLEAR

CONGA / BONGO							
Conga H Mute	Conga H Open	Conga L		Bongo H	Bongo L		
Cuica Mute	Cuica Open			Surdo Mute	Surdo Open		CLEAR

TIMBALES / COWBELL							
Timbale H	Timbale L			Cowbell			
							CLEAR

PERCUSSION1							
Cabasa	Shaker	Mara-cas	Claves	Castanet	Vibra-slap	Guiro Short	Guiro Long
Wood High	Wood Low	Seq Click H	Seq Click L	Click Noise	Metro Click	Metro Bell	CLEAR

PERCUSSION2							
Agogo H	Agogo L	Trian-gle M	Trian-gle O	Tambou-rine	Jingle Bell	Bell Tree	Hi Q
Hand Claps	Finger -snap	Whip Slap	Scratch Push	Scratch Pull	Samba Whis H	Samba Whis L	CLEAR

### **NOTE**

Though two User Keyboard Percussion setups can be created, they cannot be memorized to Registration Memory. Only on/off data and the Keyboard Percussion Mode are memorized to Registration Memory. However, User setups can be saved to and loaded from floppy disk. (See page 95 for instructions.)

## ***Other User Keyboard Percussion Functions***

Additional operations in the User Mode include copying of Lower/Pedal Preset Keyboard Percussion to User 1 or 2, and copying from one User location to the other.

The copy operations here are convenient for creating a basic foundation over which you can make your own custom Keyboard Percussion setups, without having to start from scratch.

### **To copy the Lower Preset Keyboard Percussion to User 1:**

#### **1. Call up the K.B.P. 1 Mode page and select USER 1.**

Press the LOWER/1 button in the KEYBOARD PERCUSSION section, then use the appropriate Data Control buttons to select USER 1.

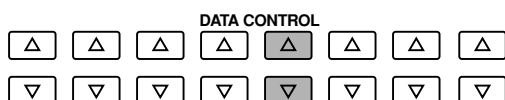
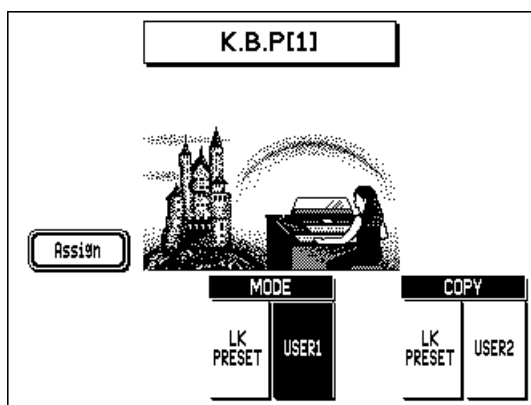

#### **2. With USER 1 highlighted, press one of the Data Control buttons below "LK PRESET" in the COPY window.**

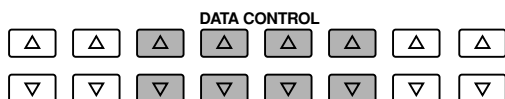
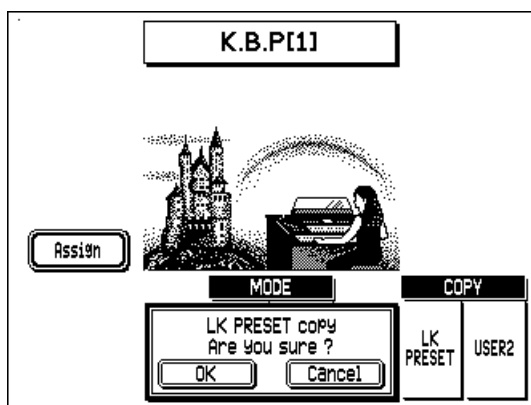

#### **NOTE**

The Lower Preset Keyboard Percussion can only be copied to User 1, and the Pedal Preset only to User 2.

### 3. At the prompt, select "OK" to copy the data, or "Cancel" to abort the operation.

Use the appropriate Data Control buttons. When the operation is finished, a "Completed" message momentarily appears in the display.

The Pedal Preset Keyboard Percussion (PK PRESET) can be copied in the same way when USER 2 is selected as the Mode.

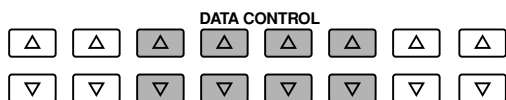
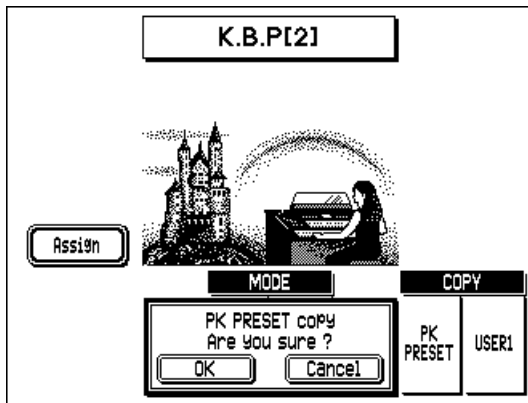

### **Copying User Locations**

You can also copy the assignments from User 1 to User 2 (or vice versa). For example, to copy from User 2 to User 1, select USER 2 in step #2 above.

# Melody On Chord

The Melody On Chord (M.O.C.) feature automatically adds a harmony part to the melodies you play on the Upper keyboard. The harmony is derived from the chords you play on the Lower keyboard — or from the chords that you indicate when using Auto Bass Chord (see page 55).

**To call up the MELODY ON CHORD page:  
Press the M.O.C./L.M. SPLIT button.**

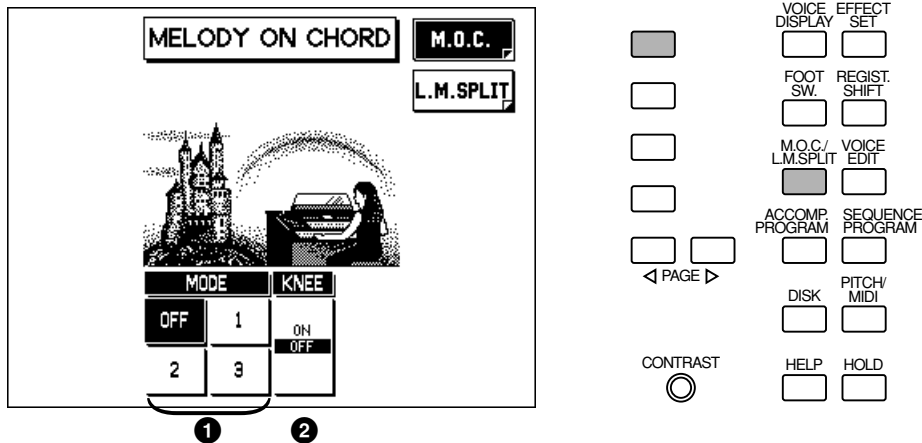

## 1 MODE

- **OFF**

Cancels the Melody On Chord function

- **Mode 1**

Produces harmonies of up to two notes in a range close to the melody played.

- **Mode 2**

Produces harmonies of up to three notes in a range close to the melody played.

- **Mode 3**

Produces harmonies of up to four notes in a range relatively distant from the melody played.

## 2 KNEE

On/off switch for knee lever control over Melody On Chord operation. To use the Melody On Chord function with knee lever control, first switch the Knee setting to ON, then select one of the three modes (described above). When the control is on, you can “play” automatic harmonies by pressing the knee lever to the right.

### **NOTE**

Melody On Chord can be heard only when at least one of the Upper Voice sections (1, 2, or Organ) have been turned on in the ENSEMBLE section and the corresponding volume settings are appropriate.

# L.M. Split

This function lets you assign different Voices to the left and right sides of the Lower keyboard, split at a user-determined key. This effectively gives you a “third” keyboard, letting you play different Voices from the left and right sides of the keyboard.

## To set the L.M. Split function:

1. Press the M.O.C./L.M. SPLIT button, and select the L.M. Split page with the appropriate Menu button.

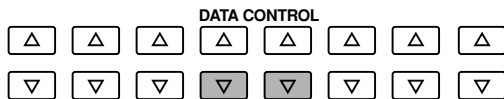
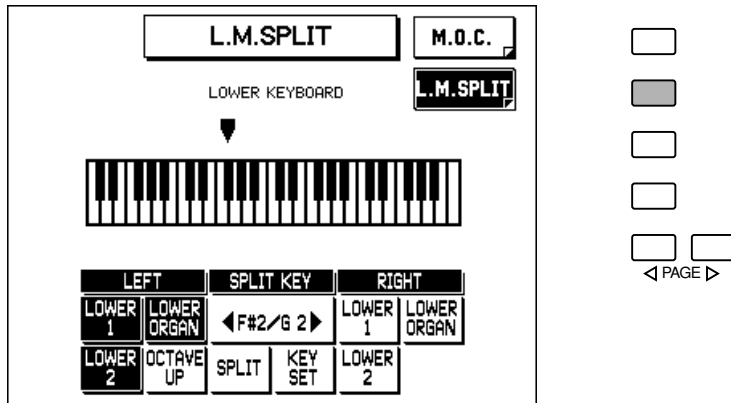

2. Turn on the Split function.

Press the Data Control button corresponding to “SPLIT” in the display. When “SPLIT” is highlighted, L.M. Split is on.

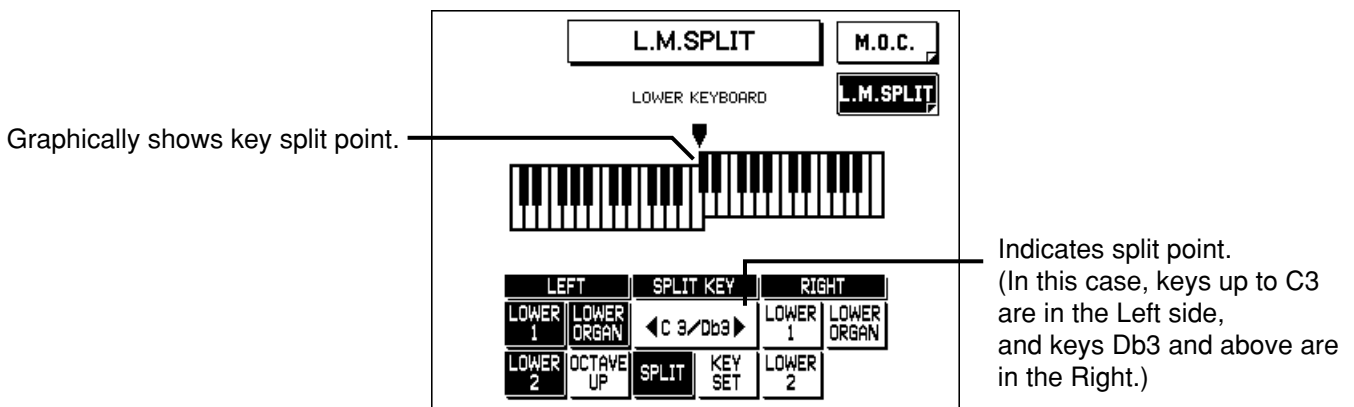

Press this to move Split Key one note lower.

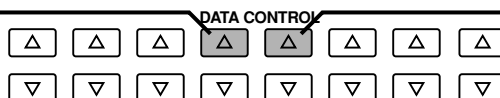

Press this to move Split Key one note higher.

### 3. Change the Key Set setting, if needed.

To do this, simultaneously hold down the appropriate Data Control button and press the desired key on the Lower keyboard.

You can also use the Data Control buttons corresponding to SPLIT KEY in the display to change the Split setting:

### 4. Set the desired Voice sections for both the Left and Right sides of the Lower keyboard.

Use the appropriate Data Control buttons. Voice sections that are highlighted can be played from the corresponding side of the Lower keyboard (as set in step #3 above).

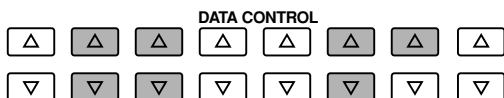
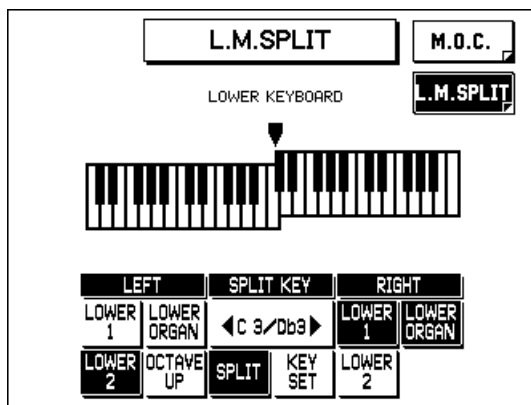

#### **NOTE**

- The same Voice section cannot be used on both Left and Right sides.
- When L.M. Split is on, the To Lower function (see page 18) is only effective on the right side of the Lower keyboard.
- When L.M. Split is on, chords cannot be detected from the right side of the Lower keyboard.

### 5. Change the Octave Up setting, if desired.

When this is on (highlighted), the selected Left Voices are transposed up one octave. This allows you to play both the Left and Right sounds in the same octave. If you intend to play bass sounds from the Left side, this should be turned off.

# Registration Memory

---

Registration Memory allows you to store virtually all the settings you make on the panel and LCD, providing a convenient way to instantly change all Voice settings and Styles while you're playing, with the simple touch of a single button on the Registration Memory panel. The buttons are conveniently located between the Upper and Lower keyboards for easy access while playing.



## Functions and settings that cannot be memorized to Registration Memory are:

- Reverb type
- Registration Shift settings
- Pitch and Transpose settings
- Voice Edit settings (except for User Voices currently assigned to the dotted buttons)
- User Styles in the Accompaniment Program (except for User Styles currently assigned to the dotted buttons)
- Sequence Program sequences
- MIDI settings
- Keyboard Percussion User Assign settings

---

## Storing Registrations

---

Newly created Registrations you make can be stored to the Registration Memory panel buttons. All Registrations in Registration Memory can also be saved to floppy disk for future recall.

### To store Registrations to the Registration Memory:

- 1. After creating your original Registration, decide which numbered button you wish to store it to.**
- 2. While holding down the M. (Memory) button in the Registration Memory section, press the numbered button to which you wish to store your Registration.**



While holding down M. button...

...press desired numbered button.

When the Registration is stored, the numbered button flashes momentarily.

---

## Selecting Registrations

---

Simply press the appropriate numbered Registration Memory button.

### **Using the D. (Disable) button:**

*The Styles also change when you select different Registration Memory buttons. Pressing the D. (Disable) button allows you to keep the same Style and its tempo throughout all your Registration changes, or make your own Style selections if you want to.*

---

## Saving Registration Data to Disk

---

You can save up to 40 sets of your own registrations (each with 16 registrations) on a floppy disk.

### **1. Insert a formatted disk in the disk slot.**

Make certain that the disk is either blank or has data you can erase. If the disk is new and unformatted, you will have to format it. (Refer to the instructions on formatting a disk on page 85.)

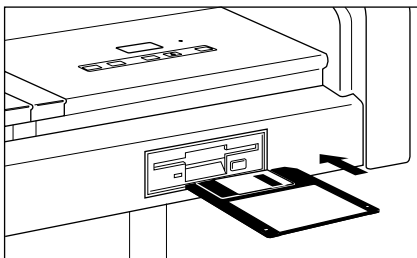

#### **NOTE**

For instructions on saving/recalling Registrations to/from the M.D.R., see pages 95, 96.

---



## 2. Select a song number with the SONG SELECT buttons in the Music Disk Recorder (M.D.R.) section.

You can also use the SONG SELECT controls in the display by pressing the appropriate Data Control buttons.

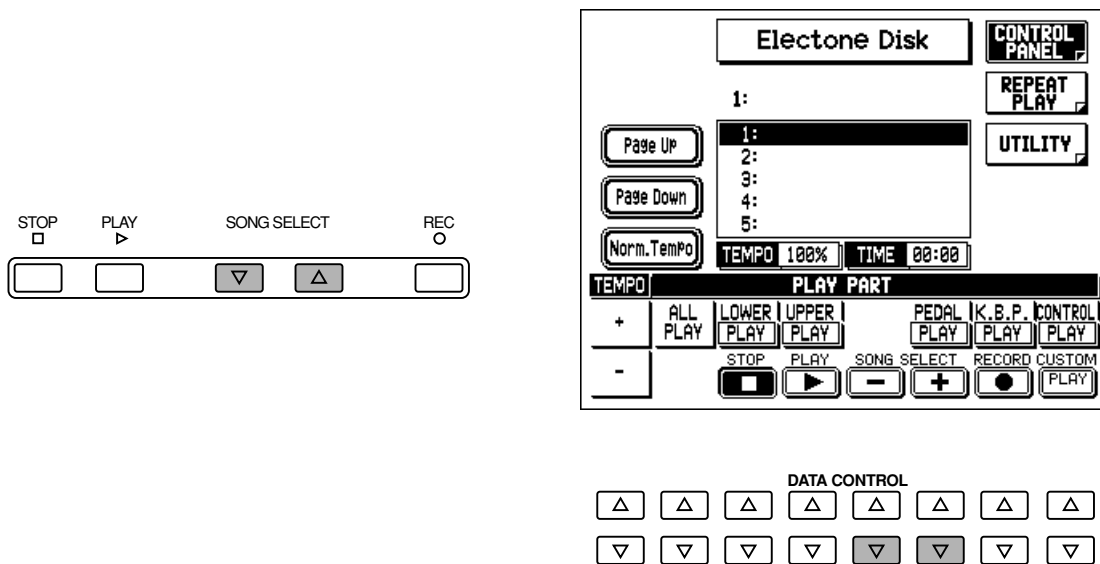

There are 40 songs, or memory locations, available on a single disk.

## 3. While holding down the REC button on the M.D.R., press the M. (Memory) button.

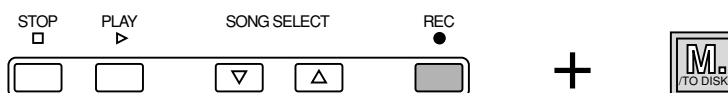

This operation saves all 16 Registrations in Registration Memory to one song. The other 39 available songs on the disk can be used for saving additional sets of 16 Registrations.

## ***Recalling Recorded Registrations (and Bulk Data)***

The Registrations (and bulk data) recorded to song numbers in the above operation can be easily loaded back to the AR-100. For instructions on this operation, see page 96.

# Registration Shift

The Registration Shift function allows you to change all Registrations — the settings you make on the panel and LCD — without taking your hands from the keyboards. By using the right footswitch on the expression pedal, you can “jump” to a specified Registration or step through the panel Registrations in sequence, either in numeric order or in any order you specify. Registration Shift has three modes: Shift, Jump and User.

**NOTE**

For best results, make sure to release any keys and pedals you are playing when changing Registrations.

**NOTE**

Only the Registrations memorized with Registration Memory can be used in Registration Shift. (The Registration Menu settings cannot be directly assigned to Registration Shift. However, you can first call up a Registration Menu Registration, memorize it to one of the Registration Memory buttons, and then use it with Registration Shift.)

## To set the Registration Shift mode:

**Press the REGIST. SHIFT button, and use the Data Control buttons to select the mode. Then, follow the instructions below for each mode.**

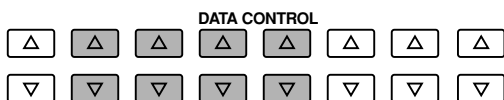
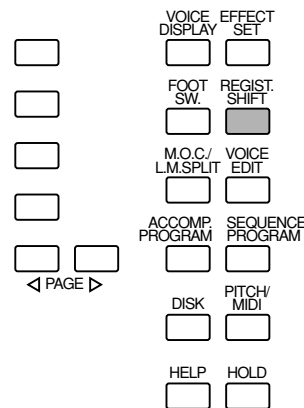
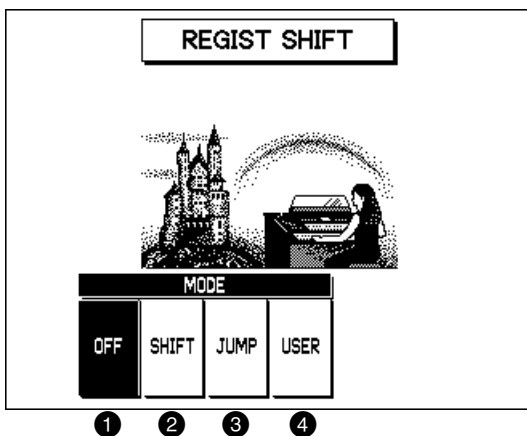

### 1 OFF

Turns the Registration Shift function off.

### 2 SHIFT

In the Shift mode, each press of the right footswitch selects the next Registration in numerical order. After the last preset is reached, the function “wraps around” to select the first preset again. The numbered buttons light up as they are selected.

### 3 JUMP

In the Jump mode, pressing the right footswitch selects a specific Registration.

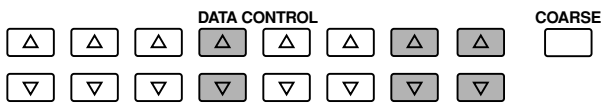
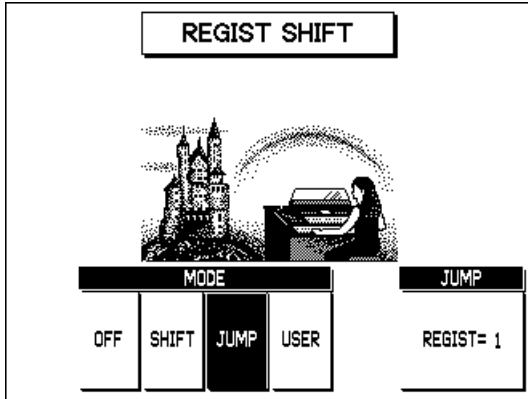

With JUMP selected in the display, use the Data Control buttons to select the desired Registration number.

### 4 USER

In the User mode, each press of the right footswitch selects the next Registration according to the order you specify. Up to 80 steps can be stored.

To set the User mode:

1. Select USER in REGIST SHIFT page.

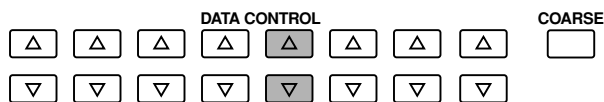
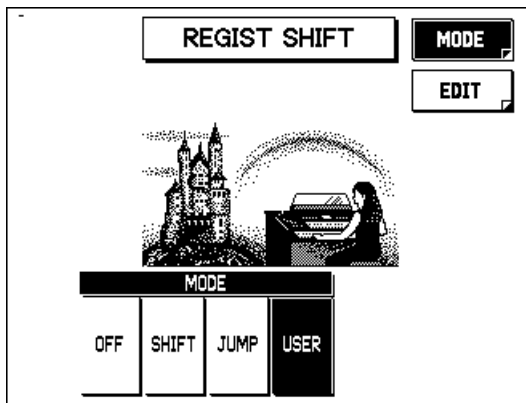

#### **NOTE**

User settings can be saved to and loaded from floppy disk. (See pages 95, 96 for instructions.)

## 2. Select the EDIT page with the Menu button.

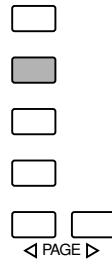
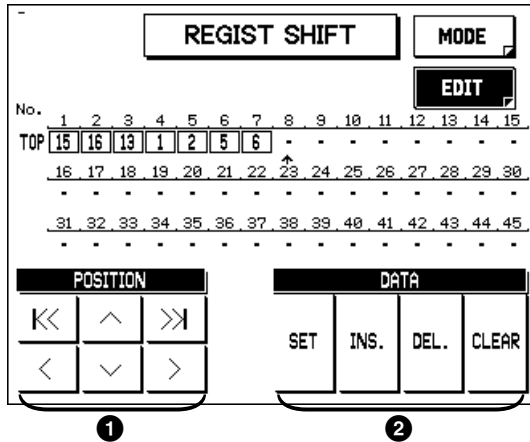

### **NOTE**

- The cursor cannot be moved unless Registration numbers have been entered.
- Though 45 Registration Shift steps are shown in the display at one time, up to 80 steps can be memorized; use the cursor controls to access the undisplayed steps.

### ① POSITION

- ◀◀ Moves cursor to the first position.
- < Moves cursor one step to the left.
- ^ Moves cursor one row up.
- ∨ Moves cursor one row down.
- ▶▶ Moves cursor to the last position.
- > Moves cursor one step to the right.

## 3. Use the POSITION controls to move the cursor along the Registration row in the display to the step you wish to edit. (Steps are shown as numbered boxes.)

## 4. Use the DATA controls (SET, INS., DEL., and CLEAR) to edit the selected Registration step.

### ② DATA

#### • SET

Initially enters (or replaces) a Registration number at the selected step. Press the desired numbered Registration Memory button (the selected button lights), then press the appropriate Data Control button to enter the selected number.

#### • INS. (Insert)

Inserts a Registration number just before the selected step, moving all subsequent numbers to the right. Press the desired numbered Registration Memory button (the selected button lights), then press the appropriate Data Control button to insert the selected number.

#### • DEL. (Delete)

Deletes the Registration number at the selected step.

#### • CLEAR

Erases all current Registration Shift settings. After selecting CLEAR, the following display appears:

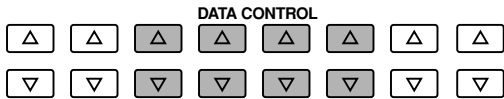
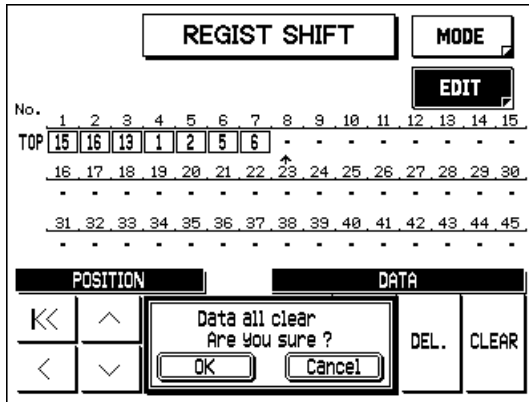

Select "OK" to clear all data (a "Completed!" message momentarily appears followed by the previous display), or select "Cancel" to abort.

Registration numbers cannot be entered beyond the Registration Shift function's capacity of 80. A "Data full...!!" message momentarily appears when the 80 spaces have been filled. If this happens, first delete unnecessary Registrations, then perform the operation again.

## ***Resetting the Electone to the Factory Preset (Power On Reset)***

All current settings including Registration Memory Registrations, User Voices and User Styles can be deleted at once by using the Power On Reset function. The factory-set Registration Memory settings are restored in this process. You can also restore the factory settings by using the Initialize Registration function. (See page 81.)

**To reset the all settings:**

- 1. Turn off the power.**
- 2. While holding down the top left Data Control button, turn the power back on.**

Be careful when using this operation, since it erases all your existing data. Always save your important data to a floppy disk using M.D.R. (see page 95) in advance.

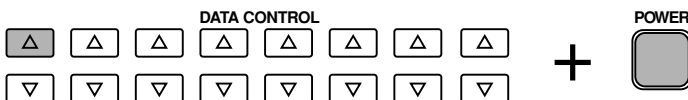

## Recall Panel Function

Turning the Electone off erases all panel settings you have made. If you have made panel settings you wish to keep, save them to Registration Memory before turning the Electone off. You can, however, recall the panel settings that were made before the Electone was last turned off. In doing this, first be careful NOT to press any panel buttons after you turn the Electone back on. Then, from the display shown below, press the MENU button corresponding to "Recall Panel" in the display to restore the previous settings.

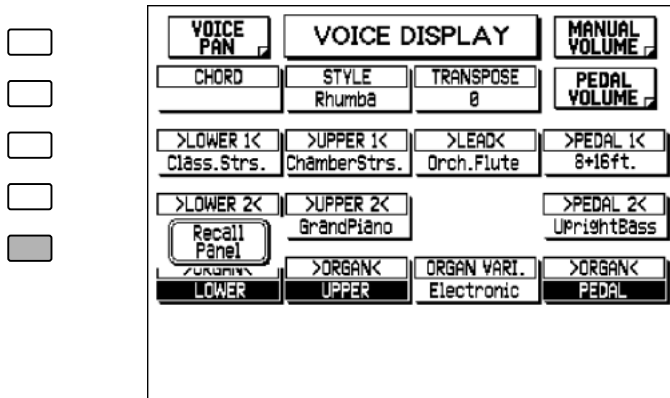

## Startup Settings

<b>UPPER</b>	Voice 1	STRINGS/Chamber Strs.
	Voice 2	PIANO/Grand Piano
	Organ	16, 8, 4, 1
	Extra	ALL OFF
<b>LOWER</b>	Voice 1	STRINGS/Class. Strs.
	Voice 2	PIANO/Grand Piano
	Organ	8, 4, 2
	Extra	ALL OFF
<b>LEAD</b>		FLUTE/Orch. Flute
<b>PEDAL</b>	Voice 1	ORGAN BASS/8+16ft.
	Voice 2	CONTRA BASS/Upright Bass
	Organ	16, 8
	Extra	ALL OFF
<b>STYLE</b>		LATIN/Rhumba
<b>SUSTAIN</b>	UPPER	OFF
	LOWER	OFF
	PEDAL	ON
<b>TREMOLO</b>		ON
<b>ORGAN VARIATION</b>		Electronic

### LOWER Voice

Voice 1	Voice 2	Organ
—	—	○

### UPPER Voice

Voice 1	Voice 2	Organ	Lead
—	—	○	—

### PEDAL Voice

Voice 1	Voice 2	Organ
—	—	○

# Initial Registration

The Initial Registration function lets you reset (initialize) all of the Registration Memory buttons to the original factory settings, without affecting any of the current panel settings. (Power On Reset, on page 79, restores the factory settings, but also automatically deletes any other current settings you have made.) This function also lets you call up individual factory preset Registrations for each Registration Memory button.

## Initializing All Registration Memory Buttons

### 1. Press one of the ORGAN PRESET buttons in the REGISTRATION MENU section.

"Initial Reg. All" appears at the top left of the display.

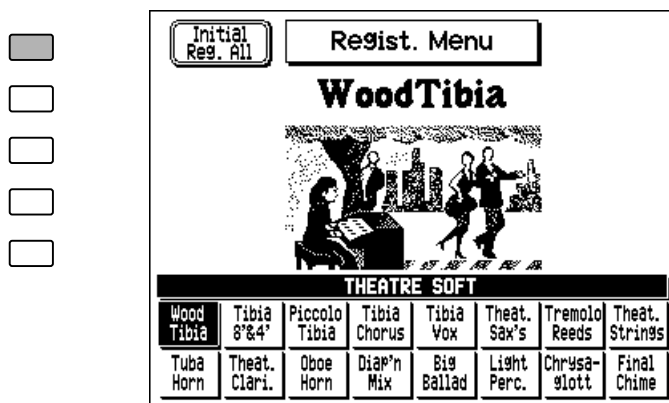
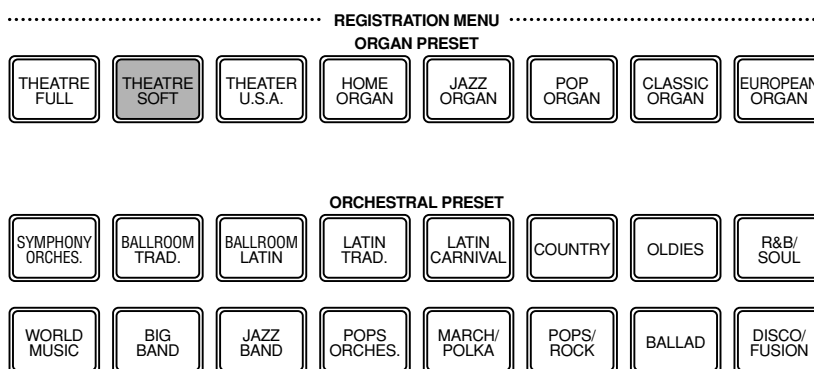

### 2. Press the Menu button corresponding to "Initial Reg. All" in the display.

All Registration Memory buttons to which you have assigned Registration settings are automatically initialized (reset to the original factory settings).

## Calling Up Individual Factory Preset Registrations (for each Registration Memory button)

### 1. Press one of the sixteen ORCHESTRAL PRESET buttons in the REGISTRATION MENU section.

"Initial Regist #" appears at the left side of the display. Each button corresponds to a different numbered Registration Memory button (as shown below).

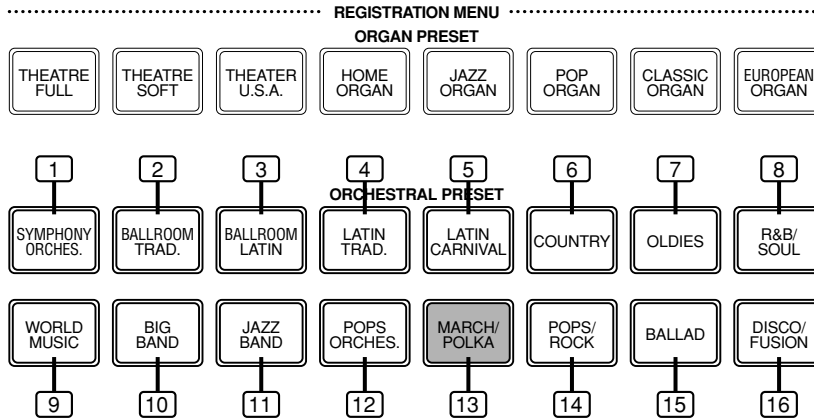

### 2. Press the Menu button corresponding to "Initial Regist #" in the display.

The factory preset Registration settings for the selected Registration Memory button is recalled, and the panel settings change accordingly.



# Music Disk Recorder

The Music Disk Recorder (M.D.R.) is a sophisticated recording device built into the AR-100 that lets you record your performances and Registration settings. The Music Disk Recorder not only records the notes you play; it also remembers the voices and rhythms you select, the front panel controls you change, as well as all expression pedal, footswitch and knee lever positions, to reproduce your performance exactly as you play it. Moreover, you can separately record different parts of your performance, building up a song part by part.

## M.D.R. Precautions

Be sure to handle floppy disks and treat the disk drive with care. Follow the important precautions below.

### Disk Types

The M.D.R. uses 3.5" 2DD and 2HD type floppy disks. A blank 2DD floppy disk has been included with your AR-100 for you to record your performances.

### Inserting/Ejecting Floppy Disks

#### To insert a floppy disk into the disk drive:

Hold the disk so that the label of the disk is facing upward and the sliding shutter is facing forward, towards the disk slot. Carefully insert the disk into the slot, slowly pushing it all the way in until it clicks into place and the eject button pops out.

#### **NOTE**

When the AR-100 is turned on, the lamp below the floppy disk slot lights, indicating that the M.D.R. is ready to use.

#### To eject a floppy disk:

- Before ejecting the disk, be sure to confirm that the M.D.R. is stopped (check that the STOP button's lamp is lit). Press the eject button slowly as far as it will go; the disk will automatically pop out. When the disk is fully ejected, carefully remove it by hand.
- Never attempt to remove the disk or turn the power off during recording, reading and playing back (when the DISK IN USE lamp is lit). Doing so can damage the disk and possibly the disk drive.

#### DISK IN USE Lamp

This red lamp lights during disk read/write operations, such as when a disk has been inserted, during recording, playback, formatting, etc.

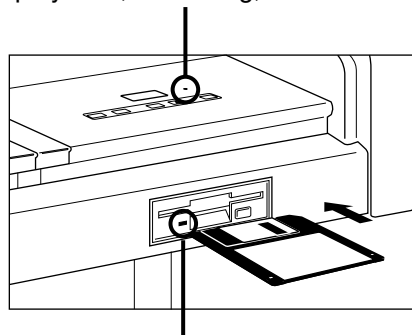

#### Drive Lamp

This green lamp is always on when the power to the AR-100 is on, regardless of M.D.R. operation.

- If the eject button is pressed too quickly, or if it is not pressed in as far as it will go, the disk may not eject properly. The eject button may become stuck in a half-pressed position with the disk extending from the drive slot by only a few millimeters. If this happens, do not attempt to pull out the partially ejected disk, since using force in this situation can damage the disk drive mechanism or the floppy disk. To remove a partially ejected disk, try pressing the eject button once again, or push the disk back into the slot and then repeat the eject procedure.
- Be sure to remove the floppy disk from the disk drive before turning off the power. A floppy disk left in the drive for extended periods can easily pick up dust and dirt that can cause data read and write errors.

## Cleaning the Disk Drive Read/Write Head

Clean the read/write head regularly. This instrument employs a precision magnetic read/write head which, after an extended period of use, will pick up a layer of magnetic particles from the disks used that will eventually cause read and write errors.

To maintain the disk drive in optimum working order Yamaha recommends that you use a commercially-available dry-type head cleaning disk to clean the head about once a month. Ask your Yamaha dealer about the availability of proper head-cleaning disks.

- Never insert anything but floppy disks into the disk drive. Other objects may cause damage to the disk drive or floppy disks.

## Using Floppy Disks

Be sure to follow these precautions when using floppy disks:

- Do not place heavy objects on a disk or bend or apply pressure to the disk in any way. Always keep floppy disks in their protective cases when they are not in use.
- Do not expose the disk to direct sunlight, extremely high or low temperatures, or excessive humidity, dust or liquids.
- Do not open the sliding shutter and touch the exposed surface of the floppy disk inside.
- Do not expose the disk to magnetic fields, such as those produced by televisions, speakers, motors, etc., since magnetic fields can partially or completely erase data on the disk, rendering it unreadable.
- Never use a floppy disk with a deformed shutter or housing.
- Do not attach anything other than the provided labels to a floppy disk. Also make sure that labels are attached in the proper location.

## Protecting Your Data (Write-protect Tab)

To prevent accidental erasure of important data, slide the disk's write-protect tab to the "protect" position (tab open). If you attempt to modify the disk when the write-protect tab is set to "on" position, a "Disk write protected!" or "Disk error!" message appears in the display, indicating that the operation is not possible. (Select "OK" at the prompt, and change the tab setting, if desired.)

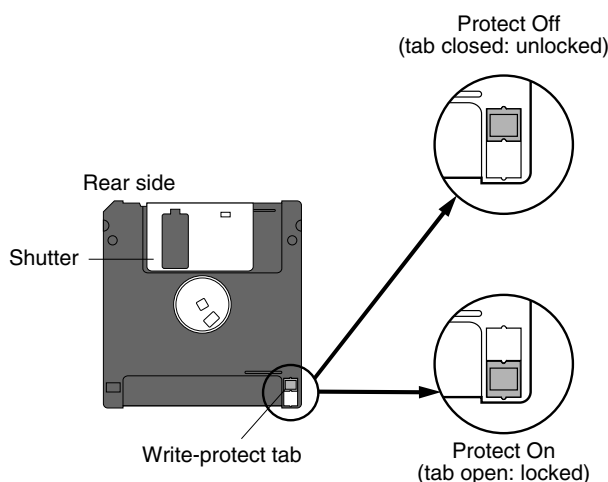

## Data Backup

For maximum data security Yamaha recommends that you keep two copies of important data on separate floppy disks. This gives you a backup if one disk is lost or damaged. To make a backup disk use the Disk Copy function on page 111.

---

# Formatting a Disk

---

Before recording your performance to a blank disk, the disk must first be formatted. (A blank 2DD floppy disk has been included with your AR-100.)

To format a disk:

1. Put the disk, label facing up, into the disk slot.

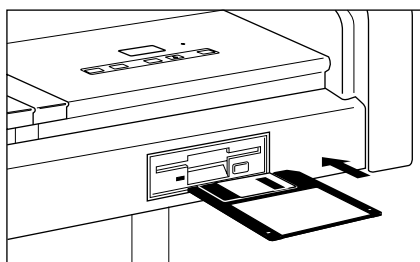

If the disk is blank, the following display will automatically appear:

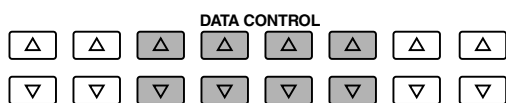
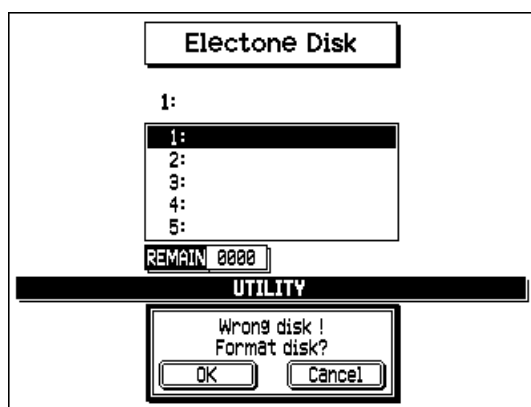

---

## **NOTE**

XG/GM, DOC or Style File disks cannot be formatted.

---

If the disk is not blank, another display may be shown. If you want to format the disk (which will erase all data on the disk), select the UTILITY page with the appropriate Menu button.

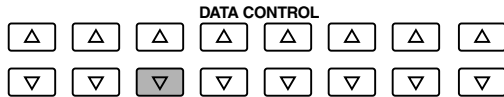
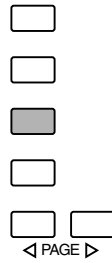
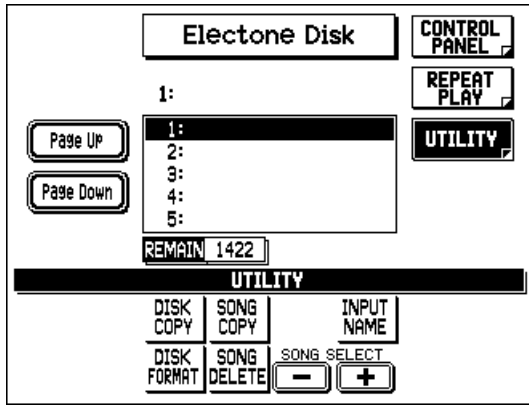

Select "DISK FORMAT" with the appropriate Data Control button.

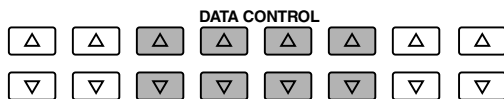
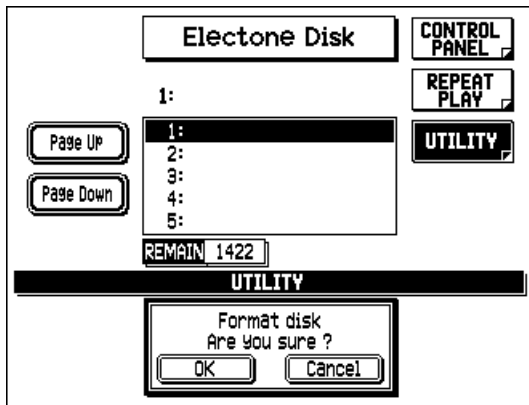

**2. At the prompt, select "OK" to begin formatting, or "Cancel" to abort the operation.**

When the REMAIN section in the display reaches "001," formatting is completed, and the CONTROL PANEL page is automatically called up.

## **Overview of M.D.R. Operation**

*Though the M.D.R. is as easy to operate as a cassette tape recorder, it is far more versatile. Since it records all Electone settings and control movements as well as the notes you play as digital data, it allows you much more flexibility and control than even the most sophisticated tape recorder. Basically, the M.D.R. independently records the following three types of data:*

### **1. Registration data (including bulk data)**

*All Registrations stored to the Registration Memory numbered buttons as well as the Registration currently set to the panel, are recorded at the beginning of a song, before the actual recording of your performance. Bulk data is also saved to the song with the Registration data. Bulk data includes Registration Shift settings, User Styles, Sequence Program sequences, Keyboard Percussion User Assign settings, Organ Variation settings, and User Voices.*

### **2. Performance data**

*The M.D.R. records your performance on the keyboards and Pedalboard of the Electone exactly as you play it, even recording the strength at which you play the keys and how hard you press them down while playing. The various types of performance data — Upper, Lower, Pedal and Lead — are recorded to independent "tracks," so that you can change any one of them without affecting the others.*

### **3. Control data**

*All changes you make on the Electone during your performance are recorded in real time. These include Registration changes, the use of the expression pedal, footswitches and knee lever.*

## **About the Logos**

*On the M.D.R. panel next to the controls are several logos. These indicate that the M.D.R. is compatible with and can play disks in the corresponding data formats: General MIDI, XG, Disk Orchestra, and Style File.*

### **GM (General MIDI System Level 1)**

An exceptionally wide variety of song data is available in the General MIDI (GM) format. GM was developed to allow song data to be used interchangeably in different devices of different manufacturers.

### **XG**

XG is a major new enhancement to the GM format developed by Yamaha, and it provides for more instrument sounds and variations, as well as greater expressive control over voices and effects. XG-compatible instruments feature full compatibility with future instruments and software.

### **Disk Orchestra**

Disk Orchestra (DOC) was developed by Yamaha, and is used in a wide variety of keyboards, tone generators, and devices — particularly the popular Clavinova series.

### **Style File**

The Style File format is an auto-accompaniment format developed by Yamaha. The rhythm and accompaniment data on Style File disks is fully compatible for use with the automatic accompaniment features of the AR-100. Inserting a Style File disk automatically calls up the display for loading data to a User Style (see page 107).

# Recording

To record a song:

## 1. Set the desired Registrations on the Electone.

Make all the settings necessary for the song you will record. This includes entering all the Registrations you will need during the performance to Registration Memory. Make sure also to select the Registration that you will use at the beginning of the song.

## 2. Insert a formatted disk into the disk slot.

### NOTE

Inadvertently pressing another panel button during M.D.R. recording or playback may change the content of the display. If this happens, press the DISK button in the DISPLAY SELECT section to restore the M.D.R. display.

## 3. Select the CONTROL PANEL page with the appropriate Menu button (if the page is not already shown).

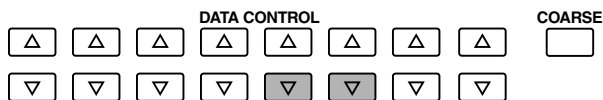
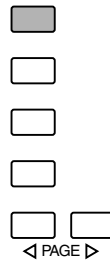
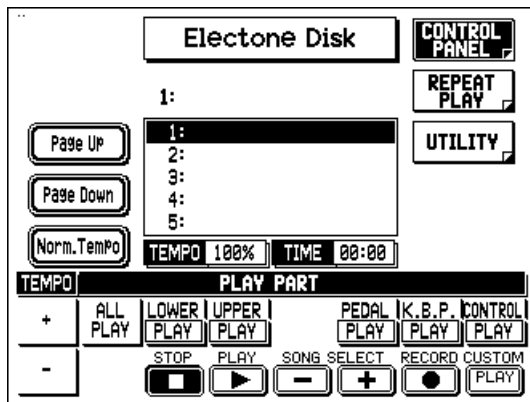

#### 4. Use the SONG SELECT buttons (or the corresponding controls in the display) to select the song number for recording.



#### NOTE

When a disk is first inserted, song number 1 is automatically selected. Song numbers 1 through 40 are available and up to 40 songs can be stored on a disk. However, the amount of available song numbers may be less depending on the amount of the song data you have recorded.

#### 5. Press the REC button (or select the corresponding control in the display).

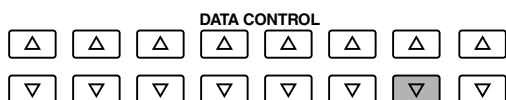
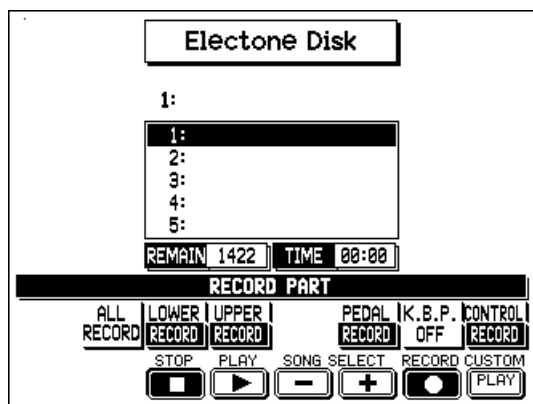

The REC button lamp lights and the PLAY button flashes to indicate that record is set to standby.

#### 6. Press the PLAY button.

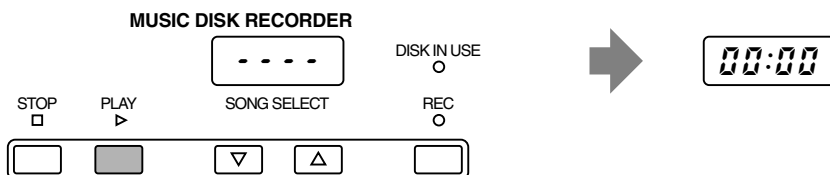

The PLAY lamp lights up and small dashes flash across the LED display from left to right, indicating that the M.D.R. is reading the Registrations and other settings.

#### NOTE

If the selected song number already contains recorded data, two dashes (" - - ") appear at the left part of the M.D.R. LED display and flash along with the song number, warning you that the selected song number already contains recorded data. If you want to execute recording operation over the song number, press the REC button again. To avoid recording over the data, select another song number for recording or press the STOP button to cancel recording.

## 7. After the elapsed recording time appears on both displays, begin playing.

There is a slight pause for setup, during which the M.D.R. records Registration and other data. Once the setup operation is complete, the elapsed recording time (starting at 00:00) appears in both the M.D.R. LED display and the main display, indicating that you can begin recording your performance.

### **NOTE**

The short time it takes to set up for recording is recorded as well, causing a short pause before playback of the song.

## **Retry Function**

**If you make a mistake during recording:**

### **1. While the M.D.R. is still recording, press the Data Control button corresponding to RETRY in the display.**

*You can perform the same operation by pressing the PLAY button (or by selecting PLAY in the display).*

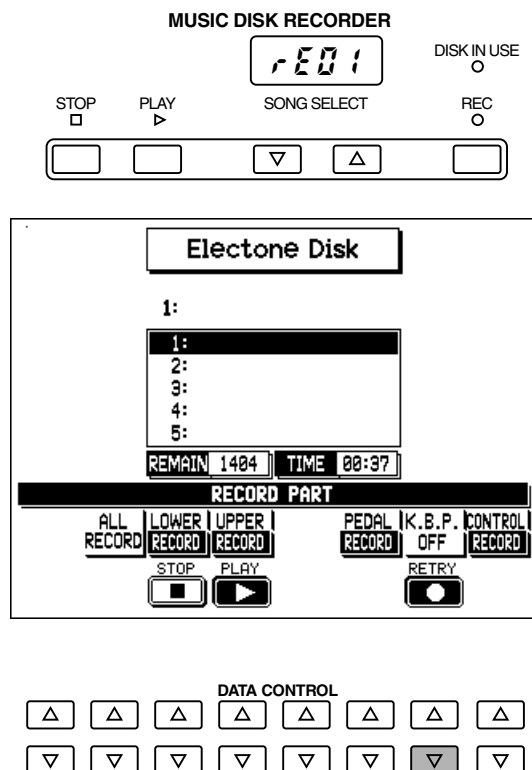

*This stops the recording and returns you to the starting point of the song.*

*The letters "rE" (retry) appear on the left side of the LED display (with the song number on the right) and the PLAY LED starts flashing, indicating that you can re-record the song.*

### **2. Press PLAY again to begin re-recording the song.**

*Re-recording starts immediately from the beginning of the song and replaces the previously recorded performance with the newly recorded performance.*



## 8. When you finish playing, press the STOP button.

The DISK IN USE lamp lights intermittently while the data is being completely recorded. When recording is completed, the M.D.R. returns to normal stop status and the new song is automatically named "SONG 1."

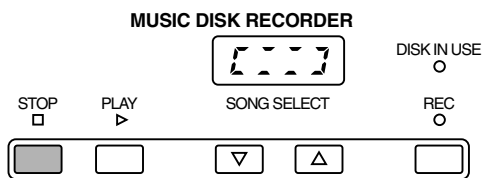

### **CAUTION**

Be sure to remove the floppy disk from the disk drive after the STOP lamp lights up (unless you intend to play back the song or record additional parts).

## 9. To hear your newly recorded performance, press the PLAY button.

Playback will begin after a couple of seconds. For more information on playback and other playback-related functions, see page 99.

### **CAUTION**

Never attempt to press the eject button or turn the power off during recording, reading and playing back. Doing so can damage the disk and possibly the disk drive. Be sure to remove the floppy disk from the disk drive before turning off the power.

## 10. Input a name for your new song.

The AR-100 automatically assigns a name and number to a newly recorded song (for example, "Song 1"). However, you can assign an original name to the song with the Input Name function (see page 97).

# Recording Parts Separately

You can also record the parts of your performance independently. For example, you can first record the chords and bass to the song (using the Lower and Pedalboard), and after that record the melody. This function also lets you record Keyboard Percussion and performance control data — such as Registration changes and expression pedal operation — separately from the other parts of the song.

## 1. Set up the M.D.R. for recording, as you did in the section above.

The first steps in recording parts separately are the same as for normal recording on page 88:

- 1) Memorize all the Registrations needed for your performance to the Registration Memory numbered buttons, and set the Registration that will be used at the beginning of the song.
- 2) Insert a formatted disk.
- 3) Select the song number to which you will record your performance, in the Control Panel page.
- 4) Press the REC button to set recording to standby.

## 2. Select the parts for recording.

Pressing the REC button in the step above automatically turns on recording for all parts (with the exception of keyboard percussion). The status of all parts is indicated in the display:

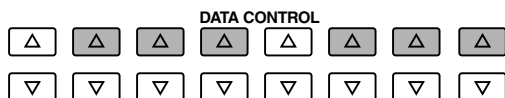
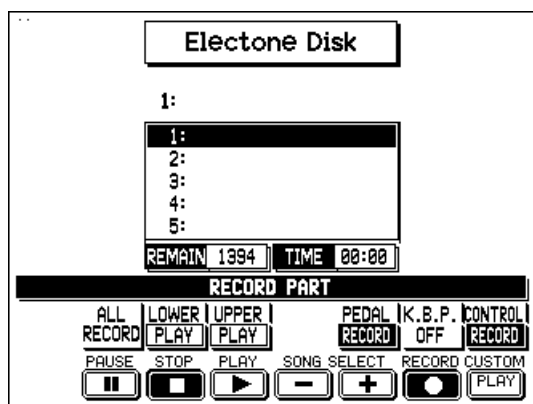

**To change the status for each part, press the appropriate Data Control button in the upper row, corresponding to the part or parts you wish to record:**

- **ALL RECORD**  
This is available only in record standby. Selecting this instantly sets all parts (except K.B.P.) to record standby.
- **LOWER**  
Lower keyboard data.
- **UPPER**  
Upper keyboard data.
- **PEDAL**  
Pedalboard data.
- **K.B.P.**  
Keyboard Percussion data. (Keyboard Percussion can be recorded and played independent of the Style patterns.)
- **CONTROL**  
Control data. (See "Overview of M.D.R. Operation" above.)

**NOTE**

---

Setting the K.B.P. part to "RECORD" automatically sets LOWER and PEDAL to "OFF," and vice versa.

---

**Each press of the appropriate Data Control button alternately selects the available settings: RECORD, PLAY, and OFF.**

- **RECORD**  
Sets the corresponding part to record standby.
- **PLAY**  
Sets the corresponding part to playback (for monitoring while recording other parts).
- **OFF**  
Turns off the corresponding part. This is useful for temporarily muting a part that has been recorded.

**3. Press the PLAY button, and start playing after numbers appear in the display.**

For example, if you've set LOWER, PEDAL and CONTROL to RECORD (and all other parts to PLAY or OFF), play the Lower keyboard and Pedalboard.

**4. After you've finished recording the first part(s), stop recording by pressing the STOP button.**

**5. Press RECORD to set up recording of the next part.**

In this example, the new recording contains the performance data of the Lower and Pedal in addition to Registration and setup data. The small dashes ("- -") appear at the left part of LED display and flash along with the song number, warning you that the selected song number already contains recorded data.

**6. Select the parts for recording and playback.**

As you did in step #2 above, set to RECORD those parts you wish to record and set to PLAY those parts you wish to monitor while recording. Set to OFF the parts you temporarily wish to mute.

## 7. Press the REC button again.

The REC lamp lights and the PLAY lamp flashes, indicating that the Music Disk Recorder is ready to record.

## 8. Press the Data Control button corresponding to CUSTOM PLAY to start recording of the new part or parts.

Playback of the previously recorded parts starts immediately, without the setup of Registration and other data. While you listen to playback of the previous parts, play the new part you wish to record. When the end of the recorded performance is reached, playback is automatically stopped and the STOP status is resumed.

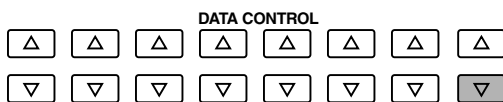
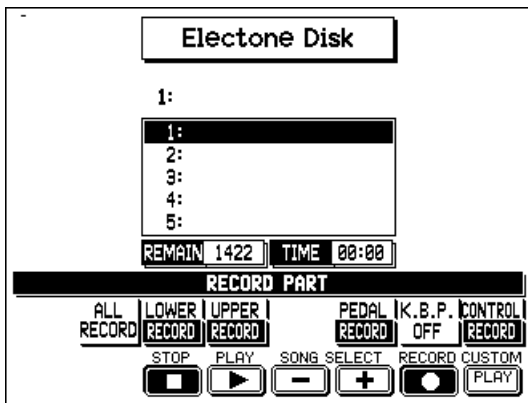

Alternately in step #8, you can press the PLAY button (or select PLAY with the appropriate Data Control button).

### **NOTE**

The length of a subsequently recorded part cannot exceed the length of the previously recorded parts. If you want to change the song length, you must first delete the song (see Song Delete on page 111) and record it again.

# Recording Registrations (and Bulk Data)

You can also record Registrations by themselves, without recording a performance. Bulk data — which includes Registration Shift settings, User Styles, Sequence Program sequences, Keyboard Percussion User Assign settings, Organ Variation settings, and User Voices — is also saved in the operation. There are two ways to record the Registrations and bulk data:

## Method #1

- 1. Set the Registrations and all other data you wish to record.**
- 2. Insert a formatted disk in the disk slot.**
- 3. Select the song number to which you wish to record the Registrations.**

Use the SONG SELECT buttons, or use the SONG SELECT controls in the display by pressing the appropriate Data Control buttons.

There are 40 songs, or memory locations, available on a single disk.
- 4. While holding down the REC button on the M.D.R., press the M. (Memory) button on the Registration Memory panel.**

This saves all 16 Registrations to one song on the disk.

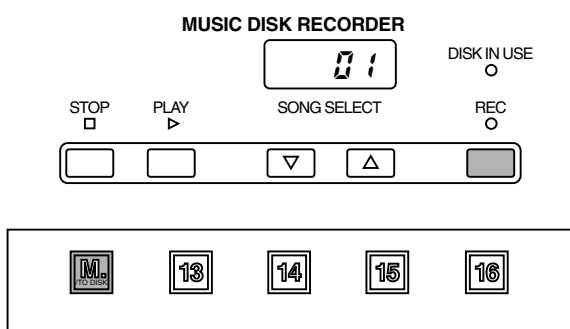

Small dashes flash across the LED display from left to right, indicating that the M.D.R. is recording the Registrations and bulk data. After recording, the M.D.R. is automatically stopped.

## Method #2

- 1. Set up the Registrations, insert a formatted disk, and select the song number.**

Follow the same procedure as given in the first three steps of Method #1 above.
- 2. Press the REC button in the M.D.R. section.**



- 3. Press the PLAY button to record the Registrations, then press the STOP button as soon as you see the small dashes flash across the LED display from left to right.**

The small dashes that flash across the display indicate that the M.D.R. is recording the Registrations and being set up for normal recording. Pressing the STOP button while the dashes are flashing allows you to record the Registrations and bulk data without recording a performance.

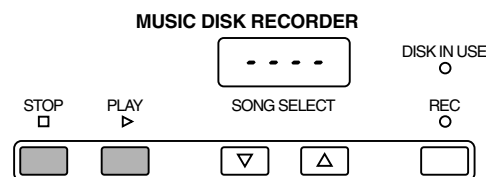

---

## ***Recalling Recorded Registrations (and Bulk Data)***

---

The Registrations (and bulk data) recorded to song numbers in the above operation can be easily loaded back to the AR-100.

### **To recall Registration data:**

- 1. Insert the proper disk and select the appropriate song number.**  
Use the SONG SELECT buttons in the M.D.R. section, or use the appropriate Data Control buttons.
- 2. Press the PLAY button.**  
When the data has been completely loaded, the M.D.R. returns to STOP status.

The M.D.R. also makes it possible to use more than the 16 Registration Memory Registrations in a performance — without having to alter the current panel settings. This would come in handy when performing several songs in succession that use more than 16 Registrations.

### **To do this:**

- 1. First record the Registrations you need into several song numbers on the M.D.R. before the performance.**  
If possible, you should record the Registrations in the order that you'll use them, for easy access during the performance.
- 2. During the performance, after all 16 Registrations from a certain song number have been used, select the next song number and press the PLAY button on the M.D.R. This replaces all 16 Registrations in Registration Memory with the new ones from the selected song number.**
- 3. By repeating the above steps, you can run through an entire performance without having to change the panel settings.**

---

## ***Replacing Registrations***

---

The M.D.R. also lets you change the Registrations of an existing song without changing the performance data. The procedure is the same as that of Recording Registrations mentioned above.

# Naming Your Song

Once you have recorded a song, you can give that song a name by using the Input Name function.

To name your newly recorded song:

1. Call up the UTILITY page with the appropriate Menu button.

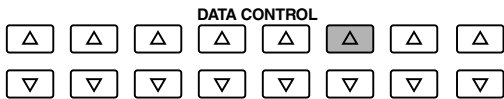
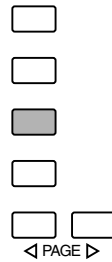
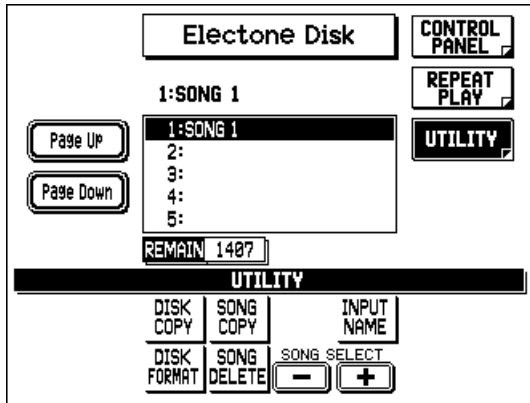

2. Select "INPUT NAME" with the appropriate Data Control buttons.
3. Select the desired set of characters (A-N, O-Z, NUMBER, or EDIT) with the Menu buttons.

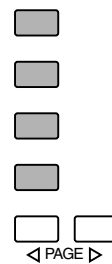
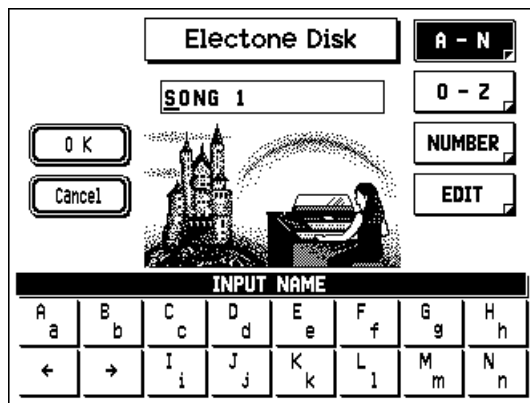

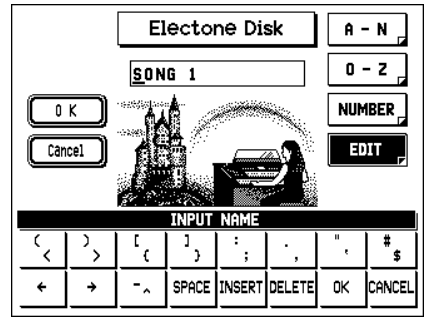
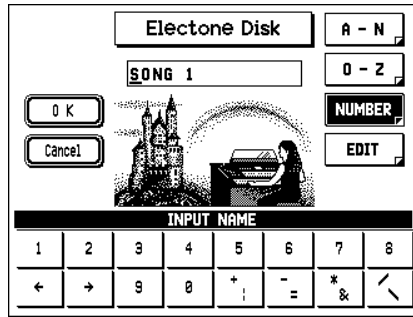
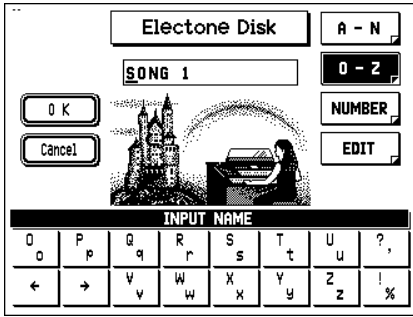

**4. Use the Data Control buttons corresponding to the cursor arrows to move the cursor position in the name.**

**5. Enter the desired character with the appropriate Data Control button.**  
To enter lowercase letters (or the lower characters in each box), simultaneously hold down the COARSE button and press the appropriate Data Control button.

**6. If needed, select other characters and use the other controls in the Edit page.**

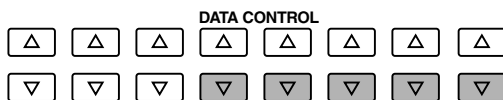
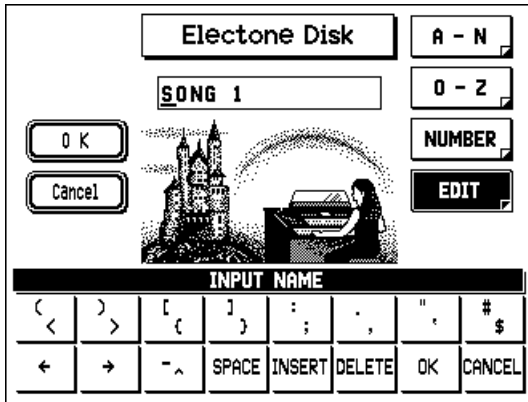

- **SPACE**  
Inserts a blank space at the cursor position.
- **INSERT**  
Inserts the selected character at the cursor position, moving other characters to the right.
- **DELETE**  
Deletes character at the cursor position.
- **OK**  
Saves the entered Song name.
- **CANCEL**  
Exits the operation without saving the Song name.

The OK and CANCEL operations can also be selected with the appropriate Menu buttons from any of the INPUT NAME pages.

**7. Save the entered song name by selecting "OK" (with the appropriate Menu button or Data control button in the EDIT page).**

When the name has been saved, the display returns to the UTILITY page.



# Playback

You can play back your recorded performance by simply pressing the PLAY button. Registrations and other data are automatically recalled to the AR-100 before playback.

## Song Playback

To play back a song:

- 1. Insert the disk containing your recorded song.**
- 2. Select the number of the song you wish to play back.**

Use the SONG SELECT buttons, or use the SONG SELECT controls in the display by pressing the appropriate Data Control buttons.

If the disk contains more than five songs, you can quickly scroll up or down through the songs by using the Page Up and Page Down menus in the display. (Press the corresponding Menu button.)

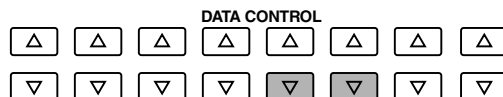
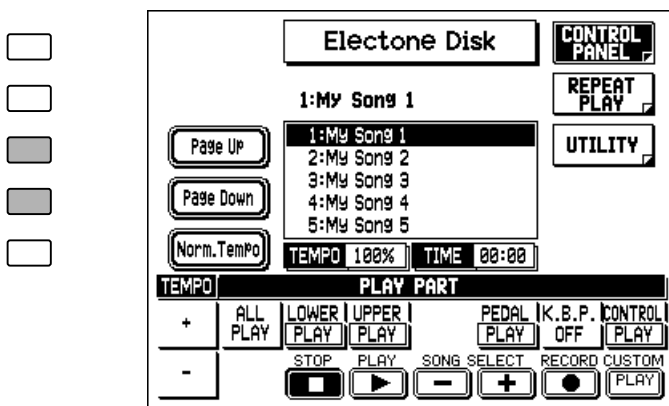

### 3. Start playback by pressing the PLAY button.

The PLAY lamp lights up and small dashes move across the display, indicating that the M.D.R. is resetting Registrations on the AR-100.

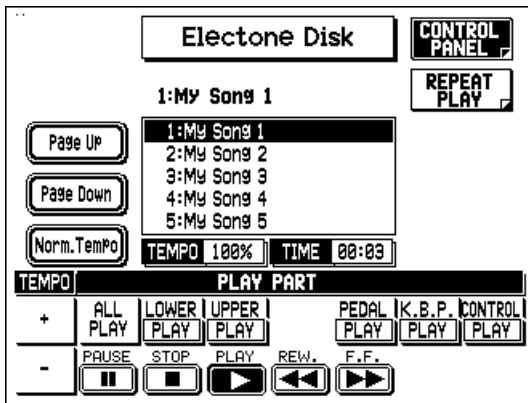
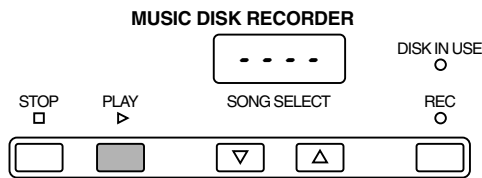

Playback of the song begins after the AR-100 data is reset and the song time is shown on both displays. During playback, the bottom row of controls changes to include the following functions: Pause, Rewind (REW.), and Fast Forward (FF.). For more information on those controls, see page 108.

Playback automatically stops at the end of a song. You can, however, stop playback in the middle of a song by pressing the STOP button.

### ***Playback of Selected Parts***

You can also play back the selected parts of your recorded performance, while other parts are temporarily turned off. This function is especially useful for manually playing a single part (such as the melody) over previously recorded accompaniment parts.

#### **To play back a selected part or parts of a song:**

##### **1. Select the number of the song to be played back.**

Use the SONG SELECT buttons or the SONG SELECT controls in the display.

##### **2. Select the part or parts for playback.**

Set the parts you wish to play back to PLAY, and set the parts you wish to mute to OFF. (Use the appropriate Data Control buttons.)

##### **3. Press the PLAY button.**

First the Registration and other data are read, then playback of the performance starts (excepting the parts that were turned off in step #2).

You can play along with the previously recorded parts. Playback automatically stops at the end of the recorded song. To stop playback before the end of the song, press the STOP button (or select STOP in the display).

## **Repeat Play**

This function allows you to repeatedly play back all songs on a disk (either in order or at random), or play back one specific song.

### **To use Repeat Play:**

#### **1. Call up the REPEAT PLAY page.**

Press the appropriate Menu button.

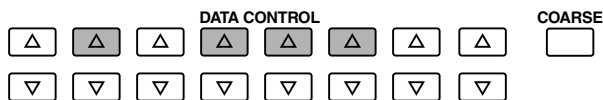
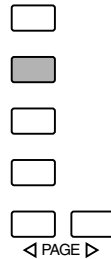
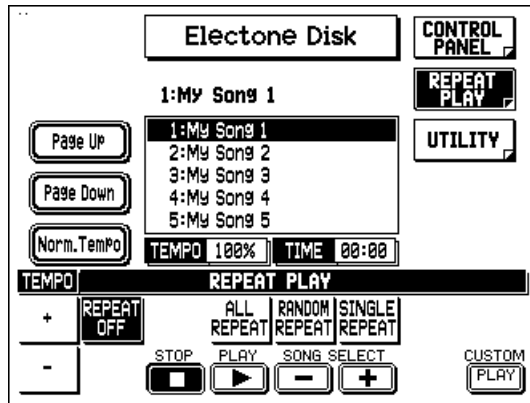

#### **2. Select the song number you wish to play back.**

If you wish to play back all songs on a disk, select the first song that will be played back. The other songs will follow.

#### **3. Select the desired Repeat Play mode: ALL REPEAT, RANDOM REPEAT or SINGLE REPEAT.**

- **ALL REPEAT**

Repeatedly plays back all songs automatically in their numerical order, starting with the selected song.

- **RANDOM REPEAT**

Repeatedly plays back all songs automatically in random order, starting with the selected song.

- **SINGLE REPEAT**

Repeatedly plays back the selected song.

- **REPEAT OFF**

Turns off the Repeat Play function. Select this during repeat playback and the M.D.R. will stop playback after the end of the song currently being played back.

#### **4. To start repeated playback of the song or songs, press the PLAY button.**

Playback will begin from the selected song and repeat indefinitely. To stop playback, press the STOP button.

## ***Playback of XG/GM Disks (optional)***

The M.D.R. is compatible with XG and GM format song data. Additional playback functions — including Solo Play, Minus One, and Part Select — are available when disks containing XG/GM song data are used.

A song disk with XG data has been included with your AR-100. Use this disk, or any other commercially available XG or GM song disk.

### **1. Insert an XG/GM song disk in the M.D.R. disk slot.**

The following CONTROL PANEL page appears:

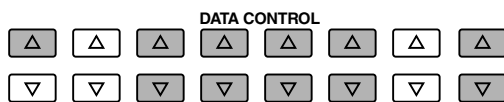
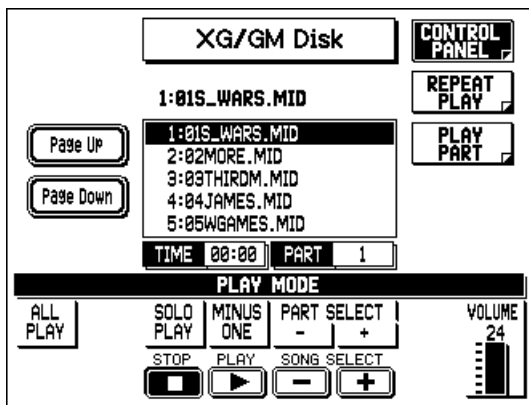

### **2. Select the song number you wish to play back.**

Use the SONG SELECT buttons or the SONG SELECT controls in the display.

### **3. Select the desired Play Mode: ALL PLAY, SOLO PLAY, or MINUS ONE.**

Use the corresponding Data Control buttons. If you are using Solo Play or Minus One, you can first use the PART SELECT controls to determine the specific part used for the function. You can also use the PLAY PART page to determine the parts.

#### **• ALL PLAY**

The All Play mode lets you play all parts of the song. You can also use the PLAY PART page (by pressing the corresponding Menu button) to turn playback of parts on or off.

#### **• SOLO PLAY**

The Solo Play mode lets you select a specific part for playback, muting (turning off) all other parts. Use the PART SELECT controls in the CONTROL PANEL page (shown in step #1 above) to select the desired part to be soloed, either before or during playback.

#### **• MINUS ONE**

The Minus One mode lets you mute (turn off) a specific part of a song, letting you play back all other parts. Use the PART SELECT controls in the CONTROL PANEL page (shown in step #1 above) to select the desired Minus One part, either before or during playback.

#### **• VOLUME**

This determines the playback volume of the XG/GM songs.

## PLAY PART Page

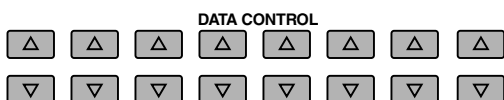
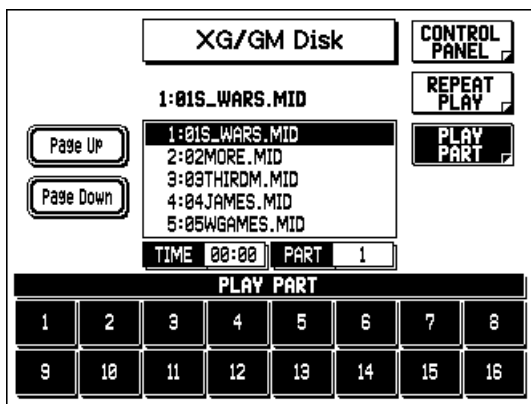

Press the Data Control button corresponding to the part you wish to turn on or off. (Parts that are on are highlighted.)

### 4. Start playback by pressing the PLAY button.

The elapsed song time is shown on both the M.D.R. display and the main display. Playback automatically stops at the end of the selected song.

All playback controls (Pause, Stop, Rewind, Fast Forward) are the same as in song playback for Electone disks (see page 108).

### REPEAT PLAY

This function is the same as for Electone disks. (See page 101.)

## ***Playback of DOC Disks (optional)***

The M.D.R. is compatible with Clavinova DOC (Disk Orchestra Collection) format song data. The Part Select function is available when disks containing DOC song data are used.

### **1. Insert an DOC song disk in the M.D.R. disk slot.**

The following CONTROL PANEL page appears:

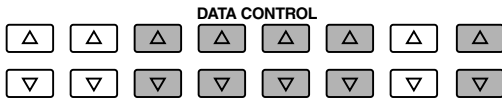
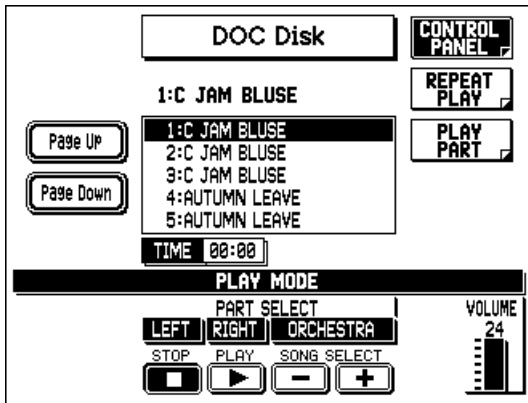

### **2. Select the song number you wish to play back.**

Use the SONG SELECT buttons or the SONG SELECT controls in the display.

### **3. Select the desired parts for playback: LEFT, RIGHT, and/or ORCHESTRA.**

Use the corresponding Data Control buttons. (Highlighted parts are on and will playback.) You can also use the PLAY PART page (by pressing the corresponding Menu button) to turn playback of parts on or off.

- **LEFT**

This turns the left-hand (chord) part of the DOC song on or off.

- **RIGHT**

This turns the right-hand (melody) part of the DOC song on or off.

- **ORCHESTRA**

This turns the orchestra backing parts of the DOC song on or off.

- **VOLUME**

This determines the playback volume of the DOC songs.

## PLAY PART Page

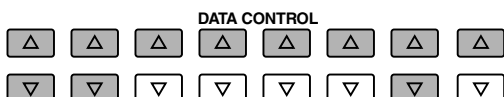
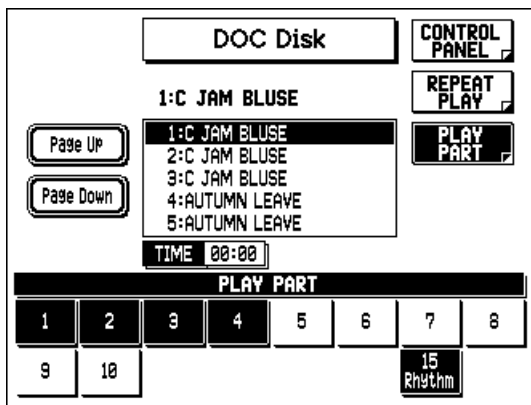

Press the Data Control button corresponding to the part you wish to turn on or off. (Parts that are on are highlighted.)

### 4. Start playback by pressing the PLAY button.

The elapsed song time is shown on both the M.D.R. display and the main display. Playback automatically stops at the end of the selected song.

All playback controls (Pause, Stop, Rewind, Fast Forward) are the same as in song playback for Electone disks (see page 108).

### REPEAT PLAY

With the exception of the Phrase Repeat function described below, this function is the same as for Electone disks. (See page 101.)

### PHRASE REPEAT

This enables the Phrase Repeat function, which allows you to repeat playback of specific sections of a DOC song. Phrase Repeat can only be used with songs which have pre-programmed Phrase Marks. (The Phrase Mark numbers are indicated in the DOC music book.)

## To use Phrase Repeat:

1. Select the desired Phrase Number with the appropriate Data Control buttons.

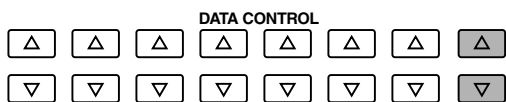
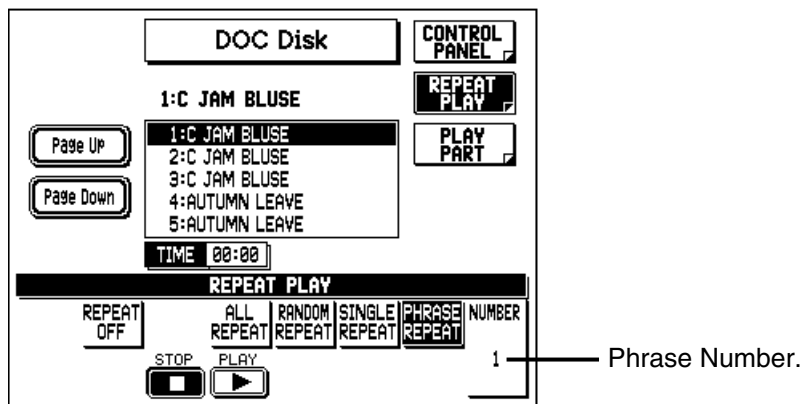

2. To repeatedly play back the selected Phrase, press the PLAY button (or select PLAY in the display).

Playback of the selected Phrase continues indefinitely. To stop playback, press the STOP button (or select STOP in the display).



---

# Loading Styles from Style File Disks

---

Many additional Styles are available for the AR-100 on disk, and these can be loaded to the eight User Style locations.

**To load a Style from a Style File disk (optional):**

**1. Insert a Style File disk in the disk slot.**

The following display appears:

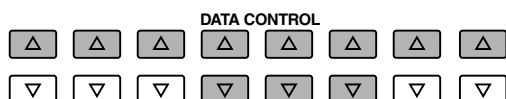
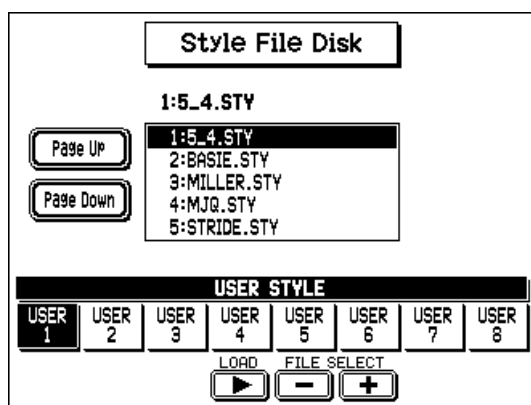

- 2. Select the Style you wish to load with the FILE SELECT controls.**
- 3. Select the destination User Style number (for loading the selected Style) by pressing the corresponding Data Control button,**
- 4. To load the selected Style to the specified User Style number, select LOAD in the display.**  
Press the appropriate Data Control button.
- 5. At the prompt, select "OK" to actually load the Style, or "CANCEL" to abort the operation.**

After the Style has been loaded, you can load additional Styles as desired by repeating steps # 2 through #5 above.

---

## Other M.D.R. Functions

---

### Custom Play

Custom Play allows you to play back the song without resetting the Registrations and other data. Custom Play can be used from either the CONTROL PANEL page or the REPEAT PLAY page.

#### To use Custom Play:

**Press one of the Data Control buttons corresponding to CUSTOM PLAY in the display.**

The song time is displayed and playback starts immediately.

### Playback Controls – Pause and Rewind/Fast Forward

These controls appear at the bottom of the display during playback of a song or songs.

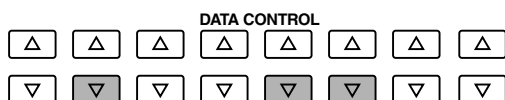
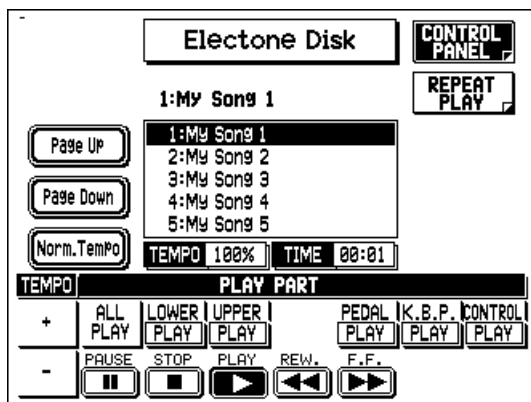

#### • Pause

You can temporarily stop playback by selecting PAUSE with the appropriate Data Control button. To resume playback from the point at which the song was paused, press the PAUSE button again. PAUSE is also available during recording.

#### • Rewind and Fast Forward

These controls function much like the similar controls on a tape recorder. Select F.F. (with the corresponding Data Control button) to advance to a later point in the song or select REW. to return to an earlier position. While either of these buttons is held down, playback stops and the song time is advanced or reversed accordingly. Hold down the button until the desired song time is shown. When the button is released, playback is automatically paused. To resume playback from the point you've advanced or reversed to, press the PLAY button (or select PLAY in the display).

#### **NOTE**

Fast Forward and Fast Reverse operate at five times the normal playback speed.

---

## Changing the Tempo

You can change the tempo of the song — either before song playback or as the song is playing — from the CONTROL PANEL page.

### To change the tempo:

**Use the Data Control buttons corresponding to TEMPO +/- in the display.**

Each press of the corresponding button slows down or speeds up the tempo by a small amount. Changing the tempo does not change the pitch of the music.

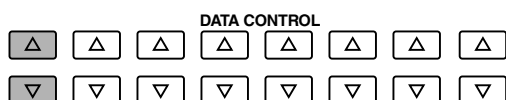
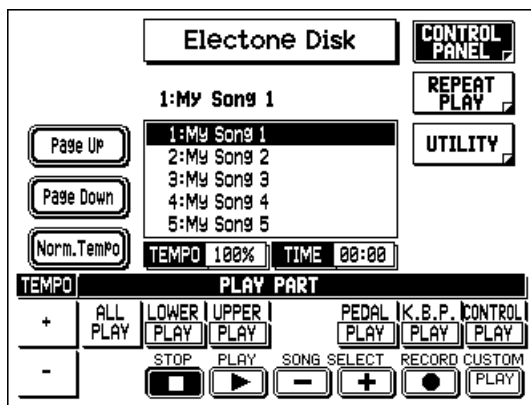

Tempo is expressed as a percentage, 100% being the normal tempo. Values less than 100 indicate a slower tempo; values greater than 100 indicate a faster tempo. You can quickly restore the normal tempo by pressing the Menu button corresponding to “Norm. Tempo” in the display. (“Norm. Tempo” is also available in the REPEAT PLAY page.)

### NOTE

- The TEMPO controls on the panel are related only to Style playback, and have no effect on M.D.R. operations.
- Tempo changes remain in effect even through changes in song number. If you have changed the tempo in one song, you should perform the step shown at the left to restore the original tempo before playing another song. Turning the power switch off and on again also restores the original tempo.
- Tempo changes cannot be made when playing XG/GM or DOC disks.

## **Song Copy**

This function lets you copy the data recorded at one song number to another song number.

**To use the Song Copy function:**

- 1. Call up the UTILITY page by pressing the appropriate Menu button.**

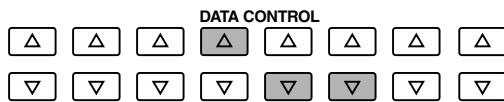
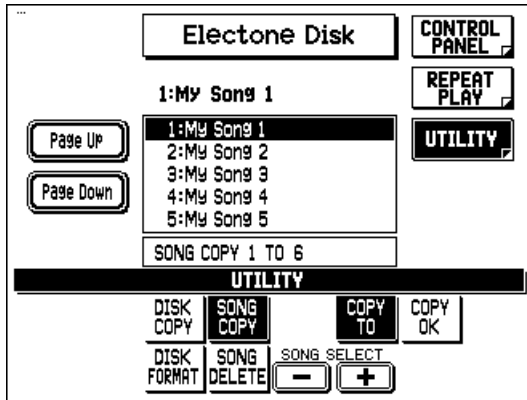

- 2. Select the song number to be copied by using the SONG SELECT buttons or the SONG SELECT controls in the display.**

### **NOTE**

If the specified song number has no recorded data, the message "No song data!" appears in the display.

- 3. Select "SONG COPY" in the display by pressing the appropriate Data Control button.**

- 4. Use the SONG SELECT buttons or the SONG SELECT controls in the display to select a destination song number for copying.**

Follow this step if you wish to select a different destination song number than the one displayed. The M.D.R. will display only those song numbers that have no data.

If all songs numbers contain recorded data, a "Song full" message appears on the display. In this case, you should erase one of the songs on the disk by using the Song Delete function (see below).

The source and destination song numbers are indicated both in the main display and the M.D.R. display. For example, when copying from song 1 to song 3, "SONG COPY 1 TO 3" appears in the main display and "01:03" appears in the M.D.R. display.

**5. Select "COPY OK" in the display by pressing the appropriate Data Control button.**

**6. To actually execute the operation, select "OK" at the prompt, or select "CANCEL" to abort the operation.**

When the song has been completely copied, the display returns to the original UTILITY page.

### **Song Delete**

Song Delete allows you to delete or erase a selected song on disk.

**To use Song Delete:**

**1. Call up the UTILITY page by pressing the appropriate Menu button.**

**2. Select the song number to be deleted by using the SONG SELECT buttons or the SONG SELECT controls in the display.**

**3. Select "SONG DELETE" in the display by pressing the appropriate Data Control button.**

**4. To delete the selected song, select "OK" at the prompt, or select "CANCEL" to abort the operation.**

When the song has been deleted, the display returns to the original UTILITY page.

### **Disk Copy**

Disk Copy allows you to duplicate the contents on one floppy disk to another. Yamaha recommends that you keep copies of your important data on two separate floppy disks by using this function.

**1. Have handy the source disk and a formatted blank disk to which you wish to copy the data.**

The source disk and destination disk must be identical in type. For example, if the source disk is a 2DD disk, use only a 2DD disk for the destination disk. For instructions on formatting a blank disk, see page 85.

Be sure to set the Write-protect tab on the source disk to ON. The destination disk, on the other hand, must be set to OFF. If you attempt to copy the disk when the write-protect tab is set to "on" position, a "Disk write protected!" or "Disk error!" message appears in the display, indicating that the operation is not possible. (Select "OK" at the prompt, and change the tab setting, if you wish to copy to the disk.)

2. Insert the source disk in the disk slot.
3. Call up the UTILITY page by pressing the appropriate Menu button.
4. Select "DISK COPY" in the display by pressing the appropriate Data Control button.
5. At the prompt, select "OK" to initiate the disk copy operation, or "Cancel" to abort.

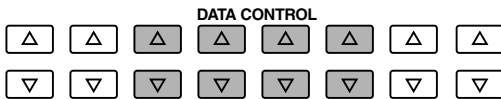
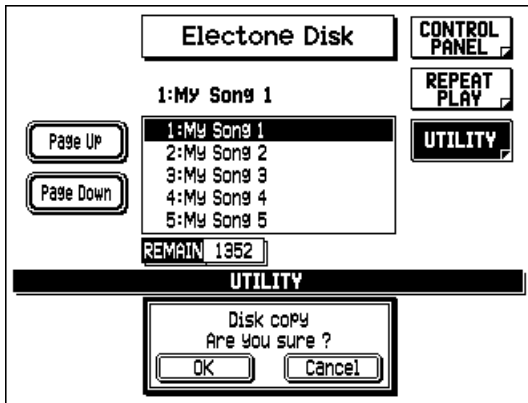

The M.D.R. starts reading the data in the source disk. (The REMAIN window and M.D.R. display both count down the remaining amount of data to be copied.)

6. When changing the disk prompt appears, press the eject button to take out the source disk.
7. Insert the destination disk.  
The amount of data remaining to be copied is shown in the display, and counts down as the copy operation continues.
8. When changing the disk prompt appears, press the eject button to take out the destination disk and re-insert the source disk.

## 9. Repeat steps #6 through #8 above as many times as necessary, following the prompts on the display.

The number of times the above steps need to be repeated depends on the amount of data to be copied and the disk type. (2DD type disks may take 2 to 16 repetitions; 2HD disks may take 2 to 31 repetitions.)

When the operation is finished, the "REMAIN" counter in the display will show "0" briefly before returning to the original UTILITY page.

### **NOTE**

An error message may appear if an error occurs in the middle of the operation. If this happens, try formatting the destination disk and attempt the operation again.

### **CAUTION**

Make sure to follow the display prompts closely, taking special care not to mix up the disks. Inserting the wrong disk may damage the disk and possibly the disk drive.

## ***Checking the Remaining Memory***

The amount of memory available for additional recording is displayed in the REMAIN section in the CONTROL PANEL page (during recording or recording standby only). It is also displayed in the UTILITY page. The maximum amount of memory is 712 for 2DD disks and 1422 for 2HD disks.

## ***Copy Protect***

Some of the Disks available for the AR-100 are purposely protected from being copied or erased. You cannot save the data to another floppy disk. If you try to load data from such a "copy-protected" disk to the AR-100, an error message will appear in the display.

## ***Important M.D.R. Error Messages***

Message	Problem and Possible Solution
Disk error! Cannot continue.	An error occurred during reading from or writing to a disk. Try changing the disk.
Disk removed! Exiting disk mode.	An error occurred because the disk was removed during a disk operation (recording, playback, etc.). Never remove a disk during a disk operation since this could damage both the disk and the drive.
Song full!	This appears when the Song Copy operation is attempted on a disk that has no empty songs. Delete one or more unneeded songs (using Song Delete), and attempt the copy operation again.
Wrong disk!	The inserted disk cannot be used, because it is either unformatted or of an incompatible format. Format the disk (using Disk Format) or insert a properly formatted disk.
Write protected! Cannot continue.	The disk operation cannot be performed, because the write-protect tab of the disk is set to the "protect" position. Remove the disk, set write-protect to off, reinsert the disk and attempt the operation again.
Disk full! Cannot continue.	The disk's memory capacity is full and no additional data can be recorded. Delete one or more unneeded songs (using Song Delete), and attempt the operation again.

# Voice Edit

In addition to the versatile Flute/Tibia section, the AR-100 has a Voice Edit feature that allows you to create your own Voices. Voice Edit uses sophisticated sound-shaping tools that make it possible to take existing Voices and craft a virtually endless variety of original sounds from them. And once you've created a Voice, you can store it to a User Voice location for future recall (see page 119).

## Selecting a Voice for Editing / Calling Up the Voice Edit Pages

### 1. First, select the Voice you want to edit.

Press the desired Voice button, then select a specific Voice in the Voice Menu. Also, in order to properly hear the to-be-edited Voice, make sure that all other Voice sections are turned off in the ENSEMBLE section.

### 2. While holding down the VOICE EDIT button, press the same Voice button again.

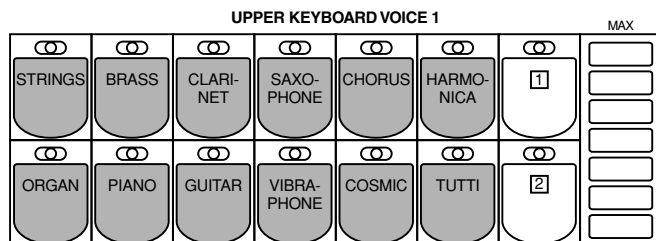
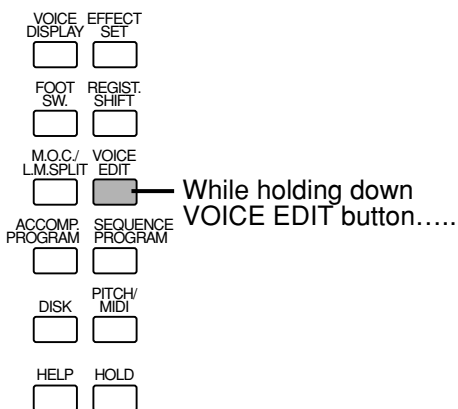

...press desired Voice button.

If you hold down VOICE EDIT without selecting a Voice, the following display will prompt you to complete the step.

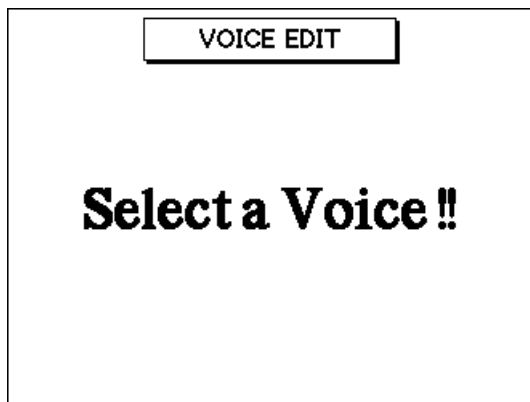

If you release VOICE EDIT without selecting a Voice, the display returns to the Voice Display.



After you have selected a Voice, the following display (or one similar) will appear:

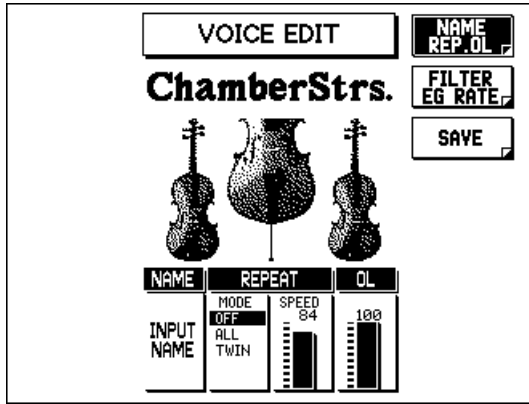

### 3. Use the Menu buttons to select the desired Voice Edit page, and edit the Voice according to the instructions that follow.

#### VOICE EDIT — NAME REP. OL (Name/Repeat/OL) Page

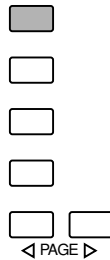
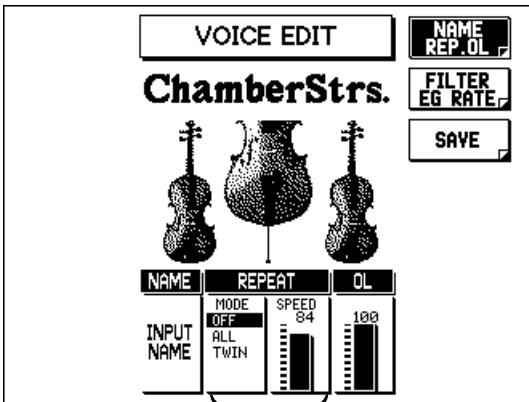

① ② ③

#### ① NAME

- **INPUT NAME**

This calls up the INPUT NAME pages for assigning an original name to the edited Voice. (For details, see page 118.)

#### ② REPEAT

The Repeat function produces repeating notes, when you hold a key or chord on the keyboard. There are two modes: All and Twin. (These modes only change the Repeat sound when more than one note is held.) The repeat speed is adjustable.

- **MODE (OFF, ALL, TWIN)**

**OFF**

Turns Repeat off.

**ALL**

Repeats all of the notes in a held chord.

**TWIN**

Alternately repeats the highest note with the lower notes in a held chord.

• **SPEED**

Determines the speed of the Repeat function. The higher the value, the faster the speed. Range:0 – 100

**NOTE**

Some Voices may not sound properly if the Speed parameter is set too high (fast). These include Voices with naturally slow attacks (such as some of the Strings, Chorus, and Cosmic Voices) and Voices whose Attack parameter (see page 117) has been set to a slow value.

**3 OL (Output Level)**

Determines the level of the Voice. Range: 0 – 100

**VOICE EDIT — FILTER / EG RATE Page**

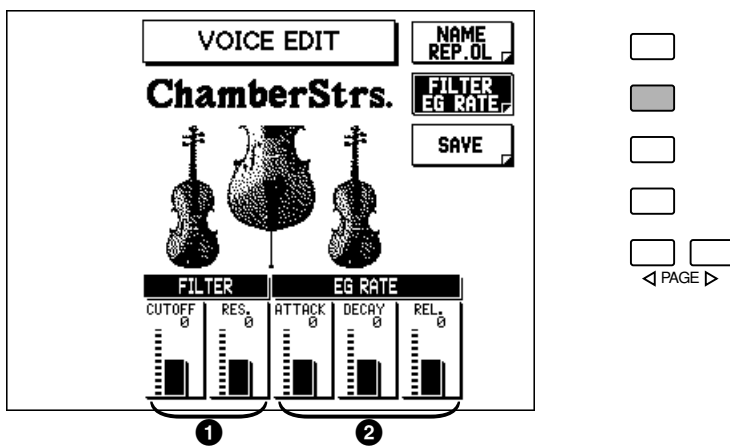

**1 FILTER**

These settings determine the overall timbre of the sound by boosting or cutting a certain frequency range. In addition to making the sound either brighter or more mellow, Filter can be used to produce electronic, synthesizer-like effects.

• **CUTOFF**

Determines the cutoff frequency or effective frequency range of the filter. (See diagram below.) Higher values result in a brighter sound. Range: -50 – +50

• **RES. (Resonance)**

Determines the emphasis given to the cutoff frequency, set in Cutoff above. (See diagram below.) Higher values result in a more pronounced effect. Range: -50 – +50

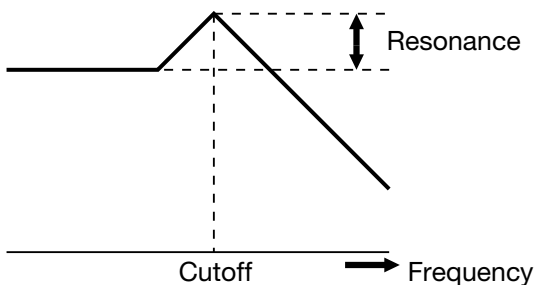

**NOTE**

The Resonance effect varies depending on the Voice. For some Voices, extreme positive values for Resonance may result in noise or even no sound. For other Voices, the Resonance effect may be negligible no matter what value is set.

## ② EG RATE

The EG (Envelope Generator) settings determine how the level of the sound changes in time. This lets you reproduce many sound characteristics of natural acoustic instruments — such as the quick attack and decay of percussion sounds, or the long release of a sustained piano tone.

- **ATTACK**

Determines how quickly the sound reaches its maximum level after the key is played. The higher the value, the quicker the attack. Range: -50 – +50

- **DECAY**

Determines how quickly the sound reaches its sustain level (a slightly lower level than maximum). The higher the value, the quicker the decay. Range: -50 – +50

- **REL. (Release)**

Determines how quickly the sound decays to silence after the key is released. The higher the value, the shorter the release. Range: -50 – +50

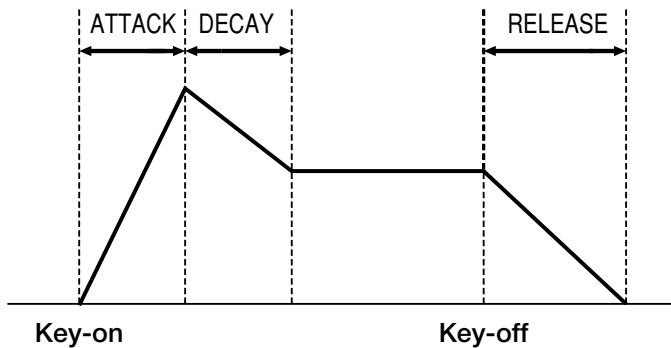

# Naming Your Voice

Once you have created your own Voice, you can give that Voice a name.

To name your newly created Voice:

1. Call up the NAME/ REPEAT/ OL page (see "Selecting a Voice for Editing" above for instructions), and select INPUT NAME with the appropriate Data Control buttons.

VOICE EDIT | A - N | ChamberStrs. | O - Z | NUMBER | EDIT | OK | Cancel

INPUT NAME							
A	B	C	D	E	F	G	H
a	b	c	d	e	f	g	h
←	→	I	J	K	L	M	N
i	j	k	l	m	n		

VOICE EDIT | A - N | ChamberStrs. | O - Z | NUMBER | EDIT | OK | Cancel

INPUT NAME							
O	P	Q	R	S	T	U	?
o	p	q	r	s	t	u	,
←	→	V	W	X	Y	Z	!
v	w	x	y	z	%		

VOICE EDIT | A - N | ChamberStrs. | O - Z | NUMBER | EDIT | OK | Cancel

INPUT NAME							
1	2	3	4	5	6	7	8
←	→	9	0	+ !	- =	* &	/

VOICE EDIT | A - N | ChamberStrs. | O - Z | NUMBER | EDIT | OK | Cancel

INPUT NAME							
<	>	[	]	:	.	"	\$
←	→	^	SPACE	INSERT	DELETE	OK	CANCEL

2. Follow the instructions on pages 97, 98 (steps #2 - #6).

The procedure for naming User Voices is the same as that of naming songs, described in the Music Disk Recorder section.

## NOTE

This operation only saves the name of the Voice; it does not save the Voice itself. (See "Saving Your User Voice" below.)

# Saving the Edited Voice

After you have created and named a new Voice, you should save that Voice for future use.

## 1. Select the Save page.

Press the appropriate Menu button.

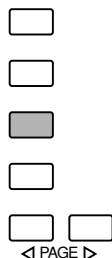
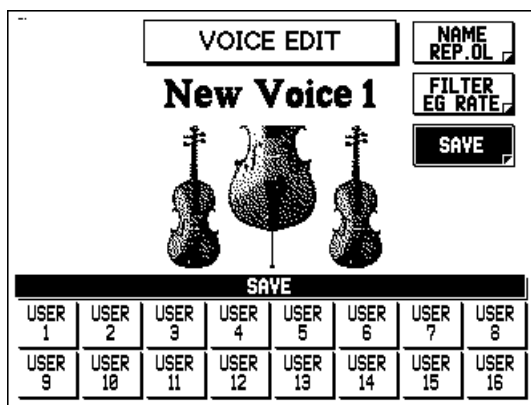

## 2. Select the desired User Voice number (1–16) with the appropriate Data Control button.



### **CAUTION**

This operation automatically erases any Voice that had been previously saved to the selected User Voice number. You should check the User Voices (see page 120) before saving a Voice to make sure that you will not be erasing any important Voices.

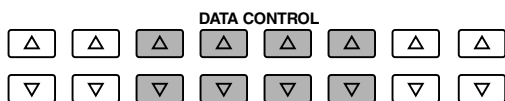

## 3. At the prompt, select "OK" to save the Voice, or "Cancel" to abort the operation.

Use the appropriate Data Control buttons. A "Completed" message briefly appears when the Voice has been saved.

# Quitting Voice Edit

You can quit the Voice Edit function from any of its display pages.

To quit:

1. Press the VOICE EDIT button in the DISPLAY SELECT section once again.

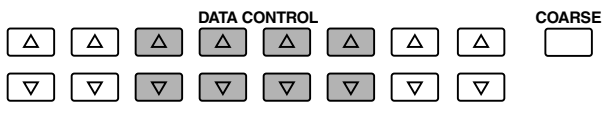
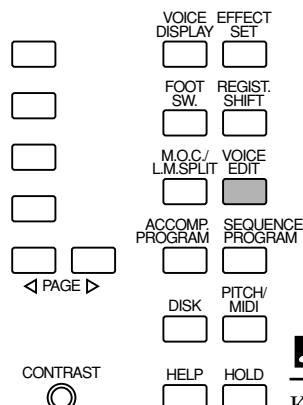

### NOTE

Keep in mind that unlike in most other pages and functions, you cannot quit Voice Edit simply by pressing a different function's button in DISPLAY SELECT.

2. At the prompt, select "OK" to quit Voice Edit, or "Cancel" to continue editing.

# Recalling an Edited Voice

Once you've saved a Voice you can assign it to one of the dotted buttons for selecting and playing.

To recall a User Voice:

1. Press the dotted button to which you wish to assign the User Voice.

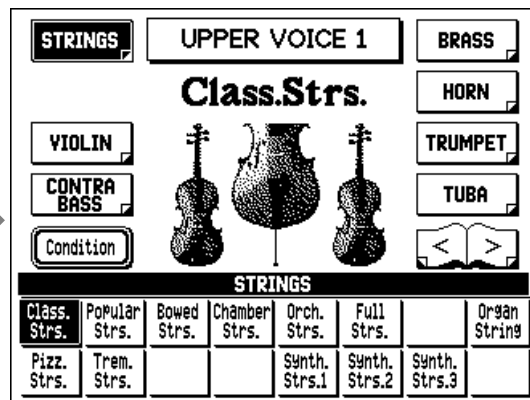
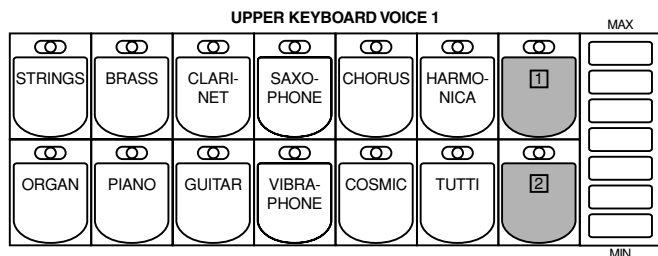

- Use the PAGE buttons to scroll through the various Voice category selections until "USER VOICE" is shown.

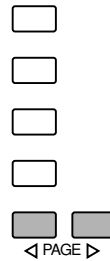
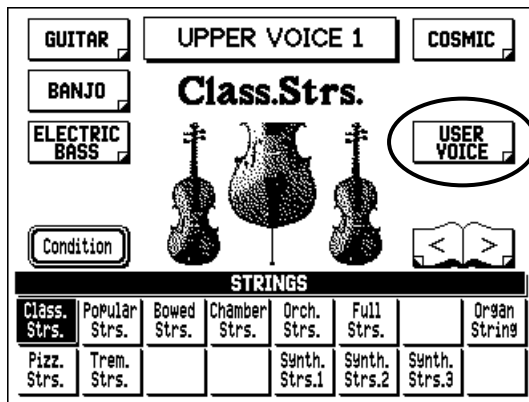

- Press the Menu button corresponding to "USER VOICE" in the display.

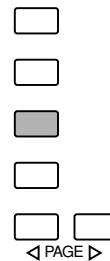
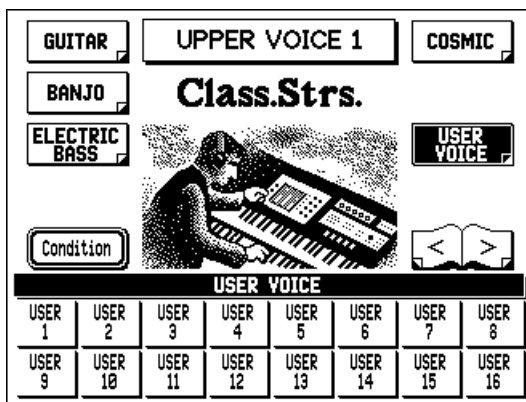

- Press the Data Control button corresponding to the User Voice you wish to select.

User Voices can also be saved to and loaded from floppy disks. (See below.)

---

## ***Saving User Voices to Disk***

---

Once you have created your own User Voices, you'll want to save them to disk. Doing so allows you to free up memory in the AR-100 for creating additional Voices. Also, the User Voices you've saved to disk can be loaded back to the AR-100 any time.

User Voice data is included in the bulk data that is saved when you record Registrations to disk. Refer to the section "Recording Registrations," page 95, for instructions.

---

## ***Loading User Voices from Disk***

---

The User Voice data saved to disk as part of bulk data can instantly be loaded back to the AR-100. Refer to the section "Recalling Recorded Registrations," page 96, for instructions.

# ***Accompaniment Program***

---

The AR-100 features two powerful rhythm/accompaniment programming functions: Accompaniment Program and Sequence Program.

The Accompaniment Program function lets you create up to eight of your own original User Styles, each of which includes rhythm patterns, bass and chord parts, and other instrumental phrases. Moreover, you can create up to five different sections for each Style: Intro, Main A and B, Fill In, and Ending. The true power and flexibility of this feature, however, is that the original User Styles can be used with the A.B.C. automatic accompaniment, so that when you play or indicate chords on the Lower keyboard, your custom-recorded accompaniment changes chords automatically.

The AR-100 lets you store up eight User Styles for instant recall. However, you can save additional User Styles to floppy disks — letting you create an unlimited library of Styles for future use. When recording a User Style, you can select an existing Style and customize it for your own requirements, or create a completely new Style from scratch.

---

## ***Calling Up the Accompaniment Program Function***

---

**When editing an existing Style:**

### **1. Select a Style.**

Press the appropriate button in the STYLE section, then select a specific Style from the Style Menu.

Selecting a preset Style for Accompaniment Program is a quick and efficient way to create your own User Styles, since it lets you make changes to already existing patterns and phrases.



STYLE								RHYTHM	BASS/ CHORD
								MAX	MAX
SEQ. 1	SEQ. 2	POP ROCK USER 1	ENTERTAIN USER 2	BALLAD USER 3	LATIN USER 4	BALL-ROOM	1		
SEQ. 3	SEQ. 4	POP R&B USER 5	TRADITIONAL USER 6	COUNTRY FOLK USER 7	LATIN POPS USER 8	SWING JAZZ	2		
								MIN	MIN

**STYLE**

## Slow Mambo



Condition

LATIN							
Slow Mambo	Fast Mambo	Beguine	Rhumba	Cha Cha Cha	Organ Cha Cha	Bolero Lento	Guaracha
Bossa Stand.	Bossa Nova	Organ Bossa	Samba	Carn. Samba	Tango Argent.	Tango Conti.	Habenera

DATA CONTROL

▲	▲	▲	▲	▲	▲	▲	▲	▲
▼	▼	▼	▼	▼	▼	▼	▼	▼

## Using an Existing Style

Any Style in the AR-100 — including the User Styles you've created yourself — can be edited and further refined using the Accompaniment Program tools.

When you select an existing Style for editing, the following section data is automatically copied to the sections of the new Style:

INTRO A is copied to INTRO

MAIN A is copied to MAIN A

MAIN B is copied to MAIN B

FILL IN AA is copied to FILL IN

ENDING A is copied to ENDING

**2. While holding down the ACCOMP. PROGRAM button, press the same button in the STYLE section again.**

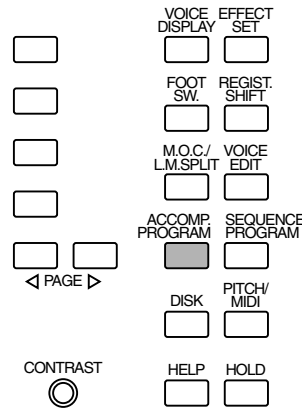

**When recording a Style from scratch:**

Simply press and release the ACCOMP. PROGRAM button.

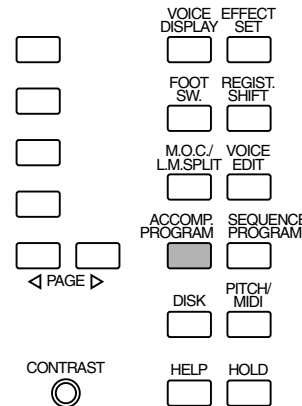
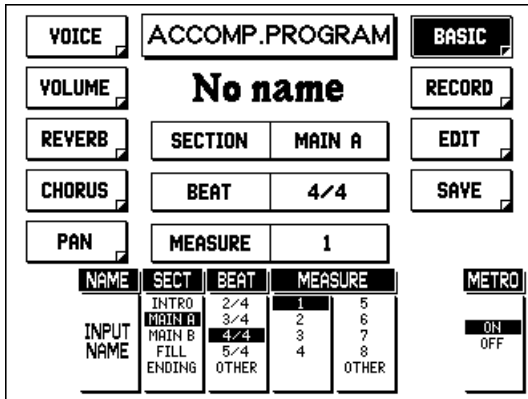

**NOTE**

• Pressing the ACCOMP. PROGRAM button to enter the Accompaniment Program function automatically stops playback of Styles or User sequences.

When recording from scratch, "No name" appears as the Style name, indicating that the Style has no data.

**About Accompaniment Program Recording – Sections, Parts and Measures**

*Before going on to record a User Style in Accompaniment Program, you should understand a little about the elements that make up a User Style. Each Style can have up to five "sections": Intro, Main A, Main B, Fill, and Ending. Generally, these sections should be stylistically similar. Each of these sections is made up of up to eight different instrumental "parts": Rhythm 1 & 2, Bass, Chord 1 & 2, Pad, and Phrase 1 & 2. Finally, the length of each section is expressed in "measures." A section can be up to eight measures long (with the exception of Fill, which can only be one measure).*

## Accompaniment Program Voice List

These Voices (shown according to their general categories) can be used for recording the Bass, Chord, Pad, and Phrase parts in the Accompaniment Program function. (See page 132.) (For a list of sounds that are available for the Rhythm part, see “Accompaniment Program Drum List” on the next page.)

Instrument Group	No.	Voice Name
Piano	1	GrandPno
	2	BritePno
	3	E.Grand
	4	HnkyTonk
	5	E.Piano1
	6	E.Piano2
	7	Harpsi.
	8	Clavi.
Chromatic Percussion	9	Celesta
	10	Glocken
	11	MusicBox
	12	Vibes
	13	Marimba
	14	Xylophon
	15	TubulBel
	16	Dulcimer
Organ	17	DrawOrgn
	18	PercOrgn
	19	RockOrgn
	20	ChrchrOrg
	21	ReedOrgn
	22	Acordion
	23	Harmnica
	24	TangoAcid
Guitar	25	NylonGtr
	26	SteelGtr
	27	Jazz Gtr
	28	CleanGtr
	29	Mute.Gtr
	30	Ovrdrive
	31	Dist.Gtr
	32	GtrHarmo
Bass	33	Aco.Bass
	34	FngrBass
	35	PickBass
	36	Fretless
	37	SlapBas1
	38	SlapBas2
	39	SynBass1
	40	SynBass2
Strings	41	Violin
	42	Viola
	43	Cello
	44	Contrabs
	45	Trem.Str
	46	Pizz.Str
	47	Harp
	48	Timpani
Ensemble	49	Strings1
	50	Strings2
	51	Syn.Str1
	52	Syn.Str2
	53	ChoirAah
	54	VoiceOoh
	55	SynVoice
	56	Orch.Hit
Brass	57	Trumpet
	58	Trombone
	59	Tuba
	60	Mute.Trp
	61	Fr.Horn
	62	BrasSect
	63	SynBras1
	64	SynBras2

Instrument Group	No.	Voice Name	
Reed	65	SprnoSax	
	66	Alto Sax	
	67	TenorSax	
	68	Bari.Sax	
	69	Oboe	
	70	Eng.Horn	
	71	Bassoon	
	72	Clarinet	
	Pipe	73	Piccolo
		74	Flute
75		Recorder	
76		PanFlute	
77		Bottle	
78		Shakhchi	
79		Whistle	
80		Ocarina	
Synth Lead	81	SquareLd	
	82	Saw.Lead	
	83	CaliopLd	
	84	Chiff Ld	
	85	CharanLd	
	86	Voice Ld	
	87	Fifth Ld	
	88	Bass &Ld	
Synth Pad	89	NewAgePd	
	90	Warm Pad	
	91	PolySyPd	
	92	ChoirPad	
	93	BowedPad	
	94	MetalPad	
	95	Halo Pad	
	96	SweepPad	
Synth Effects	97	Rain	
	98	SoundTrk	
	99	Crystal	
	100	Atmosphr	
	101	Bright	
	102	Goblins	
	103	Echoes	
	104	Sci-Fi	
Ethnic	105	Sitar	
	106	Banjo	
	107	Shamisen	
	108	Koto	
	109	Kalimba	
	110	Bagpipe	
	111	Fiddle	
	112	Shanai	
Percussive	113	TnkiBell	
	114	Agogo	
	115	SteelDrm	
	116	WoodBlok	
	117	TaikoDrm	
	118	MelodTom	
	119	Syn.Drum	
	120	RevCymbI	
Sound Effects	121	FretNoiz	
	122	BrthNoiz	
	123	Seashore	
	124	Tweet	
	125	Telephone	
	126	Helicptr	
	127	Applause	
	128	Gunshot	

## Accompaniment Program Drum List

These Drum Kits (shown with the drum/percussion sound assignments) can be used for recording the Rhythm parts in the Accompaniment Program function. (See page 132.) (For a list of Voices available for the other parts, see "Accompaniment Program Voice List" on the previous page.)

### DRUM MAP ( Part 1)

Note#	Note	Key off	Alternate assign	Standard Kit	Standard2 Kit	Room Kit	Rock Kit	Electro Kit	Analog Kit	Jazz Kit
24	C 0			Seq Click H						
25	C#0			Brush Tap						
26	D 0	○		Brush Swirl L						
27	D#0			Brush Slap						
28	E 0	○		Brush Swirl H				Reverse Cymbal	Reverse Cymbal	
29	F 0	○		Snare Roll	Snare Roll 2					
30	F#0			Castanet				Hi Q	Hi Q	
31	G 0			Snare L	Snare L 2		SD Rock M	Snare M	SD Rock H	
32	G#0			Sticks						
33	A 0			Bass Drum L			Bass Drum M	Bass Drum H 4	Bass Drum M	
34	A#0			Open Rim Shot	Open Rim Shot 2					
35	B 0			Bass Drum M	Bass Drum M 2		Bass Drum H 3	BD Rock	BD Analog L	
36	C 1			Bass Drum H	Bass Drum H 2	BD Room	BD Rock	BD Gate	BD Analog H	BD Jazz
37	C#1			Side Stick					Analog Side Stick	
38	D 1			Snare M	Snare M 2	SD Room L	SD Rock	SD Rock L	Analog Snare L	
39	D#1			Hand Clap						
40	E 1			Snare H	Snare H 2	SD Room H	SD Rock Rim	SD Rock H	Analog Snare H	
41	F 1			Floor Tom L		Room Tom 1	Rock Tom 1	E Tom 1	Analog Tom 1	Jazz Tom 1
42	F#1		1	Hi-Hat Closed					Analog HH Closed 1	
43	G 1			Floor Tom H		Room Tom 2	Rock Tom 2	E Tom 2	Analog Tom 2	Jazz Tom 2
44	G#1		1	Hi-Hat Pedal					Analog HH Closed 2	
45	A 1			Low Tom		Room Tom 3	Rock Tom 3	E Tom 3	Analog Tom 3	Jazz Tom 3
46	A#1		1	Hi-Hat Open					Analog HH Open	
47	B 1			Mid Tom L		Room Tom 4	Rock Tom 4	E Tom 4	Analog Tom 4	Jazz Tom 4
48	C 2			Mid Tom H		Room Tom 5	Rock Tom 5	E Tom 5	Analog Tom 5	Jazz Tom 5
49	C#2			Crash Cymbal 1					Analog Cymbal	
50	D 2			High Tom		Room Tom 6	Rock Tom 6	E Tom 6	Analog Tom 6	Jazz Tom 6
51	D#2			Ride Cymbal 1						
52	E 2			Chinese Cymbal						
53	F 2			Ride Cymbal Cup						
54	F#2			Tambourine						
55	G 2			Splash Cymbal						
56	G#2			Cowbell					Analog Cowbell	
57	A 2			Crash Cymbal 2						
58	A#2			Vibraslap						
59	B 2			Ride Cymbal 2						
60	C 3			Bongo H						
61	C#3			Bongo L						
62	D 3			Conga H Mute					Analog Conga H	
63	D#3			Conga H Open					Analog Conga M	
64	E 3			Conga L					Analog Conga L	
65	F 3			Timbale H						
66	F#3			Timbale L						
67	G 3			Agogo H						
68	G#3			Agogo L						
69	A 3			Cabasa						
70	A#3			Maracas					Analog Maracas	
71	B 3	○		Samba Whistle H						
72	C 4	○		Samba Whistle L						
73	C#4			Guiro Short						
74	D 4	○		Guiro Long						
75	D#4			Claves					Analog Claves	
76	E 4			Wood Block H						
77	F 4			Wood Block L						
78	F#4			Cuica Mute				Scratch Push	Scratch Push	
79	G 4			Cuica Open				Scratch Pull	Scratch Pull	
80	G#4		2	Triangle Mute						
81	A 4		2	Triangle Open						
82	A#4			Shaker						
83	B 4			Jingle Bell						
84	C 5			Bell Tree						

○ : Same as Standard Kit

Drum and percussion sounds assigned to the same Alternate Assign numbered group cannot be sounded simultaneously. For example, the Hi-Hat Open sound (group1) and Hi-Hat closed sound (also group1) cannot be sounded at the same time.

## DRUM MAP (Part 2)

Note#	Note	Key off	Alternate assign	Brush Kit	Classic Kit	Style Kit 1	Style Kit 2	Style Kit 3	Style Kit 4
24	C 0								
25	C# 0							—	—
26	D 0	○						—	—
27	D# 0							—	—
28	E 0	○						—	—
29	F 0	○						—	—
30	F# 0								
31	G 0			Brush Slap L		—	—	—	—
32	G# 0								
33	A 0				Bass Drum L2	—	—	—	—
34	A# 0								
35	B 0				Gran Cassa	—	—	—	—
36	C 1			BD Soft	Gran Cassa Mute	—	—	—	—
37	C# 1					—	—		
38	D 1			Brush Slap	Marching Sn M	—	—	—	—
39	D# 1								
40	E 1			Brush Tap	Marching Sn H	—	—	—	—
41	F 1			Brush Tom 1	Jazz Tom 1	—	—	—	—
42	F# 1		1			—	—	—	—
43	G 1			Brush Tom 2	Jazz Tom 2	—	—	—	—
44	G# 1		1			—	—	—	—
45	A 1			Brush Tom 3	Jazz Tom 3	—	—	—	—
46	A# 1		1			—	—	—	—
47	B 1			Brush Tom 4	Jazz Tom 4	—	—	—	—
48	C 2			Brush Tom 5	Jazz Tom 5	—	—	—	—
49	C# 2				Hand Cym.Open L				
50	D 2			Brush Tom 6	Jazz Tom 6	—	—	—	—
51	D# 2				Hand Cym.Closed L			—	—
52	E 2								
53	F 2					—	—	—	—
54	F# 2								
55	G 2								
56	G# 2								
57	A 2				Hand Cym.Open H				
58	A# 2								
59	B 2				Hand Cym.Closed H	—	—	—	—
60	C 3								
61	C# 3								
62	D 3					—	—		
63	D# 3					—	—		
64	E 3					—	—		
65	F 3					—	—		
66	F# 3					—	—		
67	G 3								
68	G# 3								
69	A 3								
70	A# 3								
71	B 3	○				—	—		
72	C 4	○				—	—		
73	C# 4					—	—		
74	D 4	○							
75	D# 4								
76	E 4								
77	F 4								
78	F# 4								
79	G 4								
80	G# 4		2						
81	A 4		2						
82	A# 4								
83	B 4								
84	C 5								

: Same as Standard Kit
 
 : Alternate sound (may be similar to Standard Kit)

## Drum Assignment (Upper Keyboard)

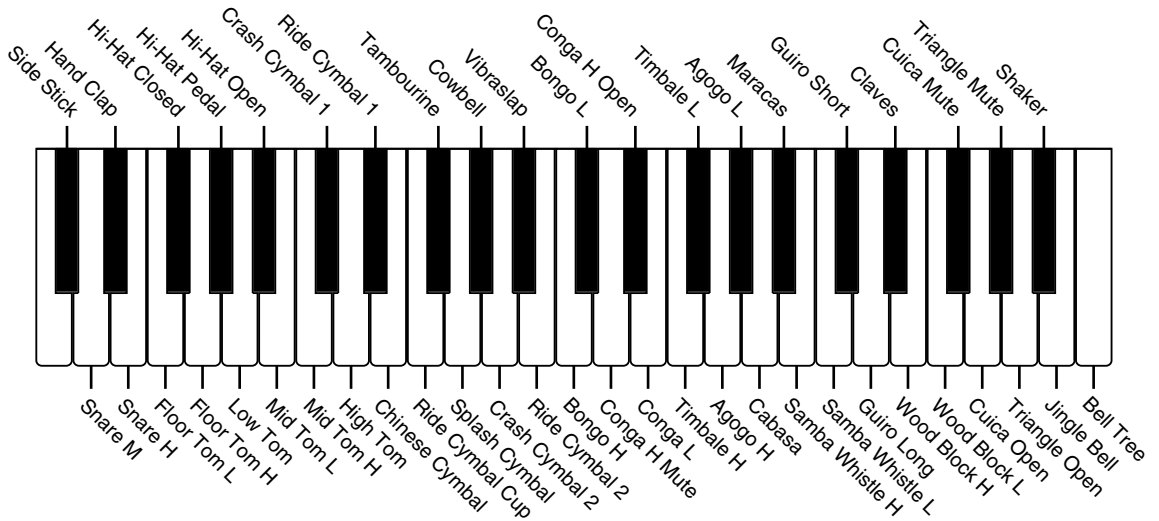

## Drum Assignment (Lower Keyboard)

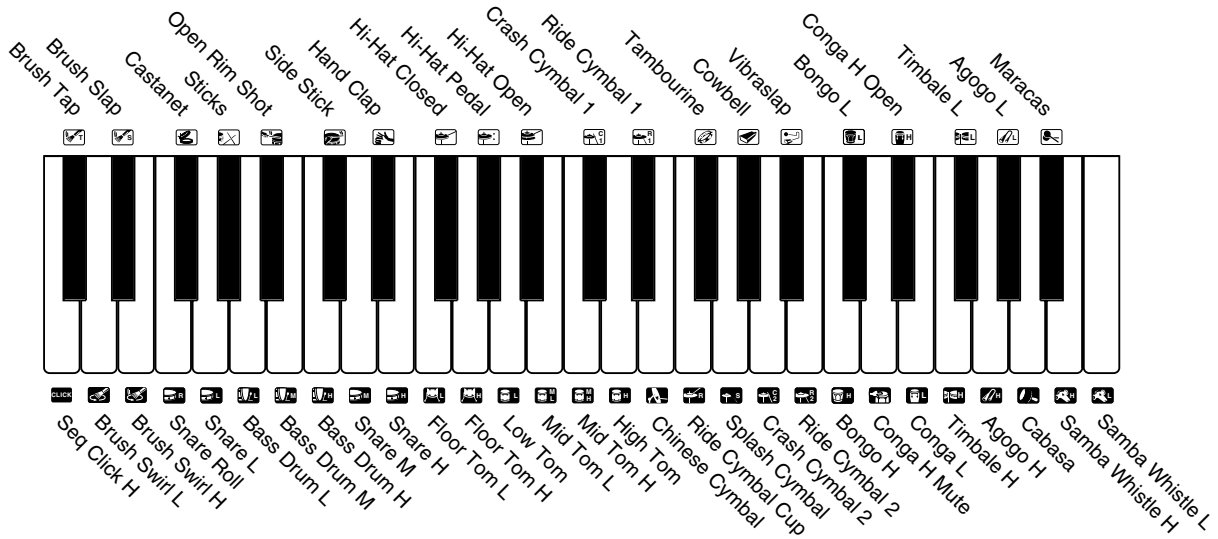

## Drum Assignment (Pedalboard)

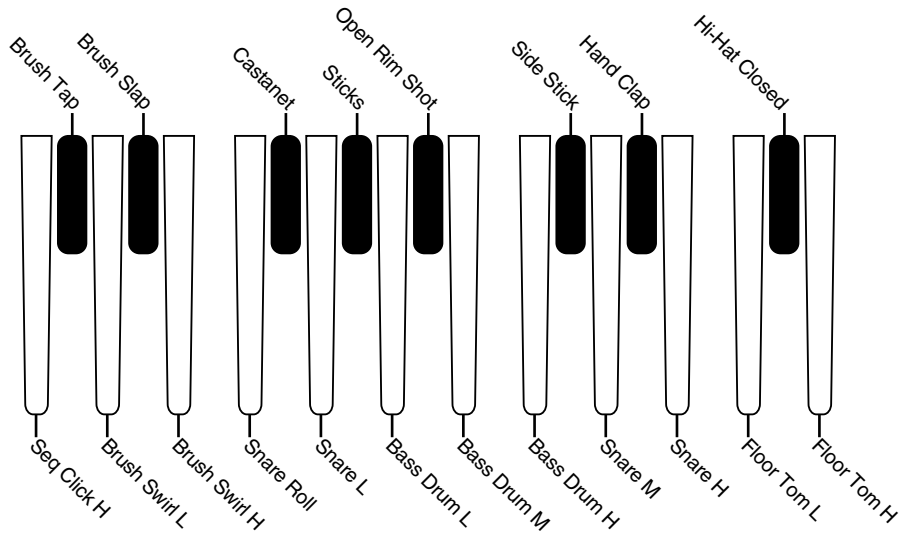

# Recording a User Style

## 1. Set up the AR-100 for recording by turning off all Voice sections in the ENSEMBLE section.

Turning off all Voice sections allows you to properly hear the parts you will be recording. Also make sure that Keyboard Percussion has been turned off (both LOWER and PEDAL).

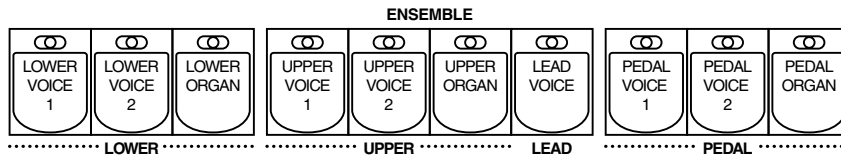

## 2. Make overall settings for the new Style (Section, Beat, Measure) from the BASIC page.

Before you start recording a new Style, some important overall settings should be made from the Basic page. First, select the section you'll be recording, then set the time signature (Beat) and length (Measure) of the Style to be recorded.

### To do this:

Select the BASIC page with the appropriate Menu button and change the settings with the corresponding Data Control buttons.

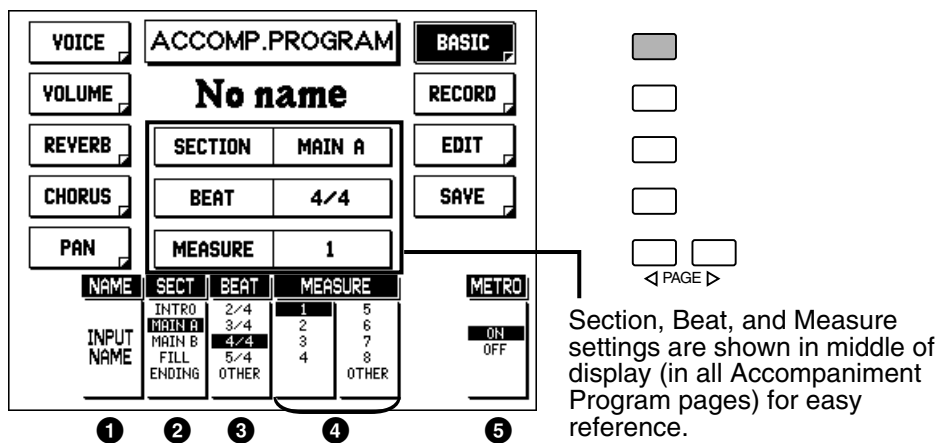

Section, Beat, and Measure settings are shown in middle of display (in all Accompaniment Program pages) for easy reference.

#### ❶ INPUT NAME

This calls up the INPUT NAME pages for assigning an original name to the created/edited Style. (See "Naming Your User Style" on page 140.).

#### ❷ SECT (Section)

This determines the section that is to be recorded. You can record five different sections for each User Style.

Settings: INTRO, MAIN A, MAIN B, FILL, ENDING

#### ❸ BEAT

This determines the time signature for the new Style. Once this is set and a section is recorded, it cannot be changed unless all recorded sections are deleted. (To delete recorded sections, see page 135.) (The "OTHER" setting can only be selected when using data from disks that has time signatures other than the available settings.)

Settings: 2/4, 3/4, 4/4, 5/4, OTHER

#### ❹ MEASURE

This determines the length (in measures) of the new Style. Once this is set and a part is recorded, it cannot be changed unless all recorded parts are deleted. (To delete recorded parts, see page 135.) (The "OTHER" setting can only be selected when using data from disks that has measure lengths of nine or greater.)

Settings: 1 – 8, OTHER

#### ❺ METRO (Metronome)

This turns the Metronome on and off. (See step #3 below.).

#### HINT

---

Once you've recorded (and saved) one section of a User Style, you will probably want to use that section as a rhythmic basis for other sections in that Style, in order to get the best musical results. To do this, first assign the new User Style to one of the dotted buttons (see page 143). Then, when you call up the Accompaniment Program function again for recording, select that Style by pressing the appropriate dotted button.

---

### 3. If there are no other recorded parts, turn the metronome on.

From the display above, use the appropriate Data Control button to set METRO (Metronome) to ON.

If you are recording a Style from scratch (and no parts have yet been recorded), you should turn the metronome on as a rhythmic guide. Once other parts (especially rhythm) have been recorded, you can turn this back off.



## 4. Set up recording for the desired part in the RECORD page.

There are eight parts available for recording: Rhythm 1 & 2, Bass, Chord 1 & 2, Pad, and Phrase 1 & 2. Record each of these one by one, listening to previously recorded parts as you continue.

### To do this:

First, call up the RECORD page with the corresponding Menu button. Then select "REC" (Record) for the instrumental part you wish to record (with the corresponding Data Control buttons).

VOICE	ACCOMP.PROGRAM				BASIC				
VOLUME	No name				RECORD				
REVERB	SECTION		MAIN A		EDIT				
CHORUS	BEAT		4/4		SAVE				
PAN	MEASURE		1						
1-RHYTHM-2		BASS		1-CHORD-2		PAD		1-PHRASE-2	
REC	REC	REC	REC	REC	REC	REC	REC	REC	REC
PLAY	PLAY	PLAY	PLAY	PLAY	PLAY	PLAY	PLAY	PLAY	PLAY
MUTE	MUTE	MUTE	MUTE	MUTE	MUTE	MUTE	MUTE	MUTE	MUTE
DELETE	DELETE	DELETE	DELETE	DELETE	DELETE	DELETE	DELETE	DELETE	DELETE

< PAGE >  
 CONTRAST

DATA CONTROL

△	△	△	△	△	△	△	△	△
▽	▽	▽	▽	▽	▽	▽	▽	▽

COARSE

### NOTE

- When you first call up the page for recording, Rhythm 1 is automatically set to record.
- Rhythm parts can be "overdubbed" (see "Recording Rhythm Parts" below). When recording to an existing Style, the other non-rhythm parts having existing data must be deleted before recording. To do this, select DELETE for the part, then select "OK" in the prompt.

### HINT

As a rule of thumb, it is best to record the parts in the order they appear (left to right) in the display. For example, first record the Rhythm parts, then the Bass parts, then Chord, etc. Since the Pad and Phrase parts are mainly for embellishment, they should be recorded last.

## 5. Select the desired Voice(s) for recording.

Before you actually record any of the parts for your User Style, you should select which Voices you will use for each part. A special set of Voices are used for recording in Accompaniment Program. (For a list of the Voices available, see page 125.)

### To do this:

First call up the VOICE page with the appropriate Menu button. Then play the keyboards and select a Voice for the part to be recorded.

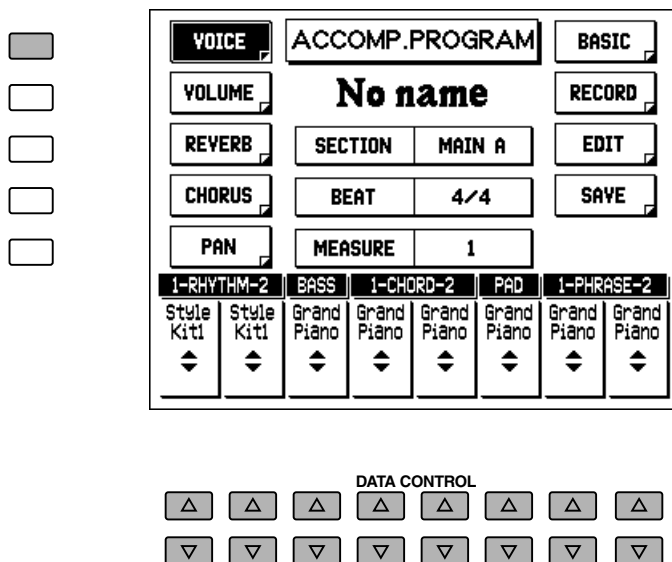

### NOTE

Only drum Voices are available for the Rhythm parts. All other Voices (except drums) are available for the other parts.

### HINT

- The advantage of having two separate Rhythm, Chord, and Phrase parts is each part can be assigned a different Voice. For example, you can use an electronic drum kit for the main rhythm in Rhythm 1, yet still have some standard drum sounds by assigning "Stand Kit" to Rhythm 2.
- You can also make Volume, Reverb, Chorus, and Pan settings for the various parts at this point, before recording — or change them later, after all parts have been recorded. (See page 139.)

## 6. Set the tempo for recording.

Use the TEMPO controls to set the tempo (or speed) for recording.



### HINT

If you wish, you can set a different tempo each time you record a part. For example, you could set a relatively fast recording tempo for parts that are easy to play, and set a slow tempo for parts that are more difficult to play. (However, make sure to set a final tempo just before saving your User Style.)

## 7. Record the selected part.

Use the START or SYNCHRO START buttons to start and stop recording.

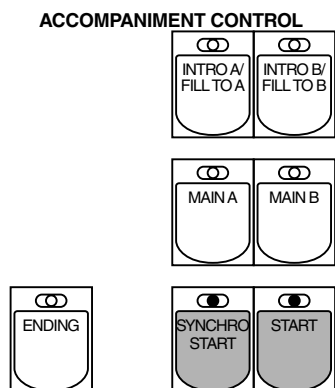

Press START to start recording immediately, or press SYNCHRO START to start recording at the first press of a key in the Lower keyboard. (Pressing a pedal in the Pedalboard can also start recording when the A.B.C. mode is set to Off or Custom A.B.C.; see page 60.) The BAR/BEAT display indicates the measures and beats during recording.



### Recording Rhythm Parts

When a Rhythm part is set to REC, the Upper/Lower keyboards and Pedalboard are automatically set to play drum/percussion sounds. (For sound/key assignments, see page 126.) Symbols for percussion sounds and the corresponding key are shown for convenience on the Lower keyboard.

Rhythm parts can be “overdubbed” — in other words, you can record additional sounds “on top” of each other as the pattern is looping. For example, you might first record a bass drum sound, and then add other drum/percussion sounds until you're satisfied with the rhythm you've created. If you wish to delete a specific percussion sound from the part and leave the others intact, use the Direct Cancel function (see page 135).

### Recording Non-rhythm Parts (Bass, Chord, Pad, and Phrase)

The Bass, Chord, Pad, and Phrase parts can also be overdubbed in the same manner as the pattern is looping. Make sure to play all these non-rhythm parts within a C major scale (C major 7) to ensure that the recorded parts will be properly used with the A.B.C. functions. Also, Direct Cancel cannot be used to delete individual notes in a non-rhythm part; you must first delete the part and re-record.

To stop recording, press the same button that you pressed to start. For example, if you used START to start recording, press START again to stop recording.

## 8. Record the remaining parts (and sections) as needed.

Continue recording in the same fashion (steps #2 – #7 above) for the other parts of the selected section, until you're satisfied with the new Style. Record in the same way for the other sections (Intro, Ending, etc.) of the Style as needed.

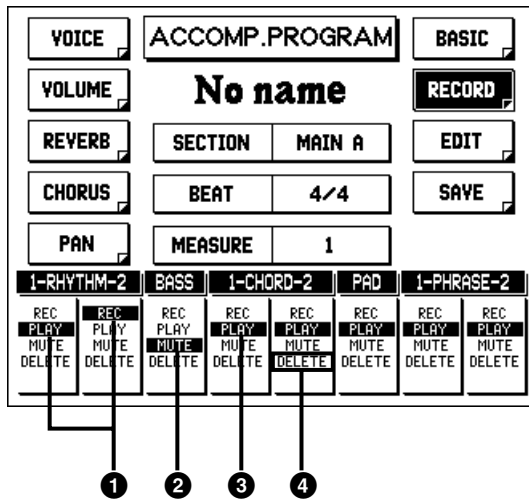

### **NOTE**

For internal Styles or Styles from a SFF disk, non-rhythm parts having existing data must be deleted before they can be recorded. However, you can overdub normally to the rhythm parts of these Styles.

- ① Setting new part to REC automatically sets previously recorded part to PLAY.
- ② Select MUTE to mute any parts you do not want to hear. (See "Mute" below.)
- ③ Select PLAY to playback the corresponding part.
- ④ Select DELETE to delete the corresponding part. (See "Delete" below.)

## **Mute**

A Mute function is also available for the parts, letting you temporarily turn off parts you do not want to hear while recording. This does not erase the part, but only temporarily disables playback, for selective monitoring of the parts.

## Delete

The Delete function erases all data recorded for the part. When DELETE is selected, the following prompt appears:

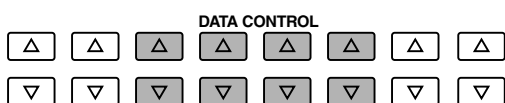
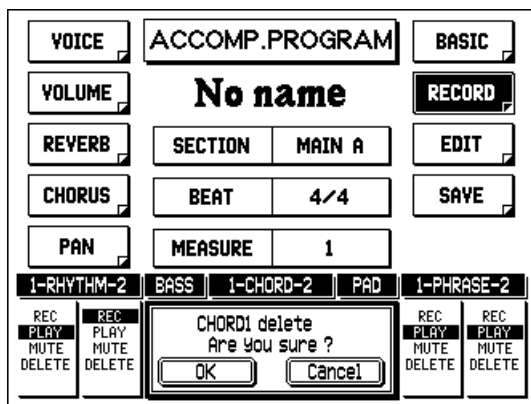

Select "OK" to delete the part, or "Cancel" to abort the operation.

## 9. Once you've recorded your new User Style, you can edit it as needed, assign a name to it, and save it for future recall.

Edit operations include Copy and Quantize (see next page) and settings for Voice, Volume, Reverb, Chorus, and Pan (see page 139).

For instructions on naming and saving a User Style, see page 140.

## Direct Cancel (Rhythm parts only)

This allows you to delete specific drum/percussion sounds from the rhythm parts.

To use Direct Cancel:

1. Set the desired rhythm part to REC.
2. Find the key or pedal corresponding to the sound you wish to delete.
3. Start recording by pressing the START button in the ACCOMPANIMENT CONTROL section.  
All instances of the sound in the part will be deleted.
4. While holding down the lowest key on the Upper keyboard, press the key or pedal corresponding to the sound you wish to delete.  
All instances of the sound in the part will be deleted.

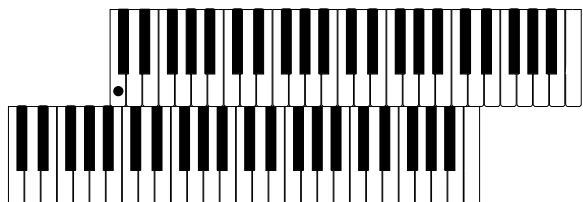

# Editing Recorded Parts – Copy and Quantize

Copy and Quantize are convenient editing functions you can perform on recorded parts. Copy allows you to copy recorded data within a part. Quantize lets you “clean up” your recorded data, making sure that all parts are rhythmically precise and accurate.

To use Copy and Quantize:

1. Call up the RECORD page (with the appropriate Menu button) and select the part to be edited by setting the desired part to REC.

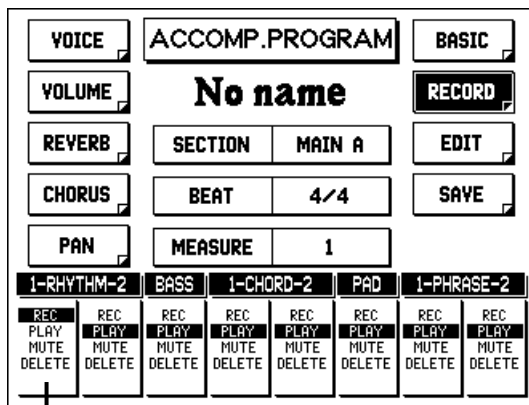

RHYTHM 1 is selected for editing.

2. Call up the EDIT page.

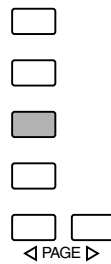
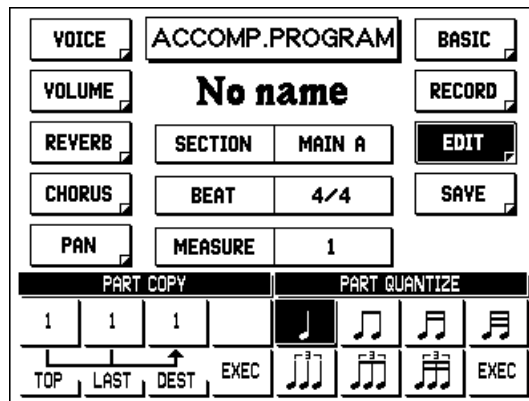

## ***Part Copy***

The Copy function allows you to copy the data from a specified range of measures in the part to another measure(s) in the part.

VOICE	ACCOMP.PROGRAM	BASIC
VOLUME	<b>No name</b>	RECORD
REVERB	SECTION MAIN A	EDIT
CHORUS	BEAT 4/4	SAVE
PAN	MEASURE 1	
PART COPY		PART QUANTIZE
1	1	1
TOP	LAST	DEST
EXEC		EXEC

DATA CONTROL

▲	▲	▲	▲	▲	▲	▲	▲
▼	▼	▼	▼	▼	▼	▼	▼

**To copy the data of a part:**

### **1. Set the TOP and LAST measures.**

The “up” Data Control button increases the value, the “down” button decreases it. These settings determine the length of the phrase to be copied. (Phrase length is automatically limited by the actual length of the Style section itself.)

### **2. Set the DEST (Destination) measure.**

This determines the measure number to which the phrase is to be copied.

### **3. Select EXEC (Execute) to copy the data.**

At the prompt, select “OK” to copy the data, or “Cancel” to abort the operation.

## Part Quantize

The Quantize function allows you to “clean up” your recorded data, making sure that the part is rhythmically accurate. Quantize aligns all notes in the part to the nearest specified beat — up to 1/32 note resolution.

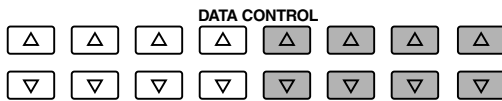
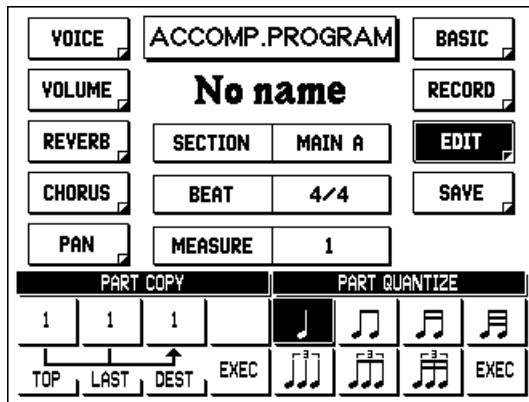

### To quantize the data of a part:

#### **1. Select the desired quantize value with the appropriate Data Control button.**

- ♪ Aligns to the nearest quarter note.
- ♪♪ Aligns to the nearest quarter note triplet.
- ♪ Aligns to the nearest 8th note.
- ♪♪ Aligns to the nearest 8th note triplet.
- ♪ Aligns to the nearest 16th note.
- ♪♪ Aligns to the nearest 16th note triplet.
- ♪ Aligns to the nearest 32nd note.

#### **2. Select EXEC (Execute) to quantize the data of the part.**

At the prompt, select “OK” to actually quantize the data, or select “Cancel” to abort the operation.

#### **HINT**

Quantize can be used with good results on all parts, but it’s especially effective with the Rhythm parts. You should use Quantize judiciously, however — the results are permanent and (depending on how accurate the actual recording was) they may not be what you expect.



# Other Settings – Volume, Reverb, Chorus, and Pan

These functions allow you to change and enhance the sound of the various parts. Each function for each part is completely independent, giving you enormous flexibility in mixing the parts. For example, you could put Reverb on one of the Rhythm parts, leave the other one “dry” with no Reverb, use Chorus to “thicken” the sound of the Pad part, and set each of the parts to different Pan positions for a wide stereo spread.

Each part can also have independent Voice settings. For details on the VOICE page, see page 132.

## To make Volume, Reverb, Chorus, and Pan settings for each part:

Call up the page corresponding to the desired function, and use the Data Control buttons to change the various settings.

### VOLUME Page

Volume Range: 0 – 24

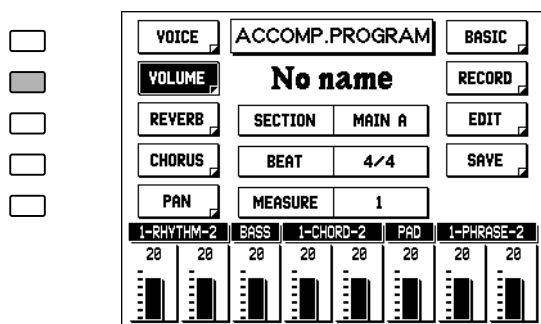

### REVERB Page

Reverb Range: 0 – 24

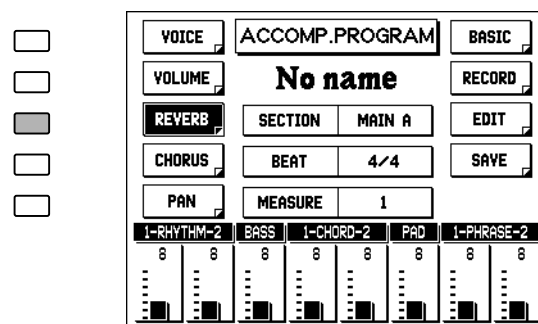

### CHORUS Page

Chorus Range: 0 – 24

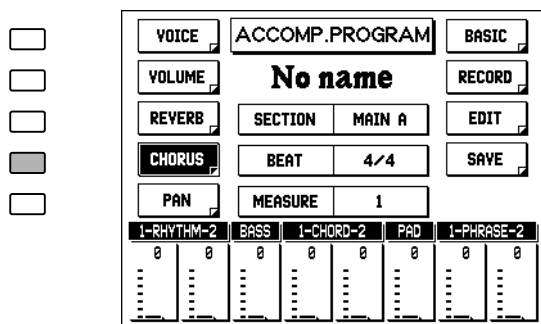

### PAN Page

Pan Settings: Seven settings (left to right)

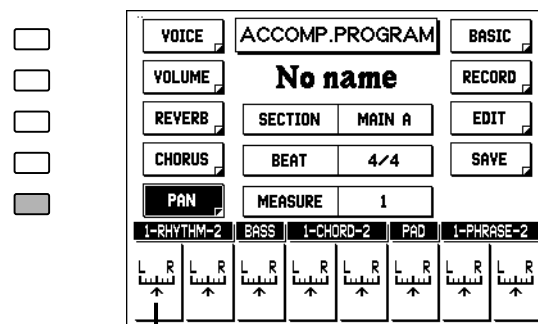

Use the ▲ Data Control buttons to move the setting to the right, and the ▼ buttons to move to the left.

---

## Naming Your User Style

---

Once you have created your own Style, you can give that Style a name.

To name your newly created or edited Style:

1. Call up the BASIC page (with the appropriate Menu button), and select INPUT NAME (with the appropriate Data Control buttons).
2. Follow the instructions in pages 97, 98 (steps #2 - #6). The procedure for naming User Styles is the same as that of naming songs, described in the Music Disk Recorder section.

### **NOTE**

This operation only saves the name of the Style; it does not save the Style itself. (See "Saving Your User Style" below.)

---

---

## Saving Your User Style

---

The AR-100 has memory space for up to eight User Styles, each with five separate sections (Intro, Ending, etc.).

1. Select the SAVE page.

VOICE	ACCOMP.PROGRAM	BASIC
VOLUME	No name	RECORD
REYERB	SECTION MAIN A	EDIT
CHORUS	BEAT 4/4	SAVE
PAN	MEASURE 1	
	SAVE TO USER	CLEAR
FREE AREA 98 %	USER 1 USER 2 USER 3 USER 4	ALL DATA
	USER 5 USER 6 USER 7 USER 8	

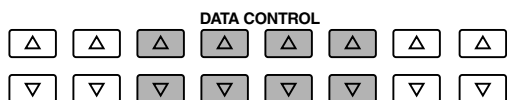

The "FREE AREA" indicates the amount of memory available (as a percentage) for saving User Styles. A value of 0% indicates that no more memory is available.

You should periodically save your Style as you are making it and check the amount of remaining memory. If the Style currently being edited cannot be saved because of a lack of memory space, delete one or more of the less necessary parts with the Delete function, and try saving the Style again.

## 2. Select the desired User location (1 - 8).

Use the appropriate Data Control buttons.

## 3. At the prompt, select "OK" to save the User Style or "Cancel" to abort the operation.

### HINT

If you are recording each section of a User Style separately (i.e., over several sessions), select that User Style each time you record new data to it, and always save it to the same User number.

---

## Clear All Data

---

This function deletes all User Styles from memory.

## 1. Press the Data Control button corresponding to CLEAR ALL DATA in the display.

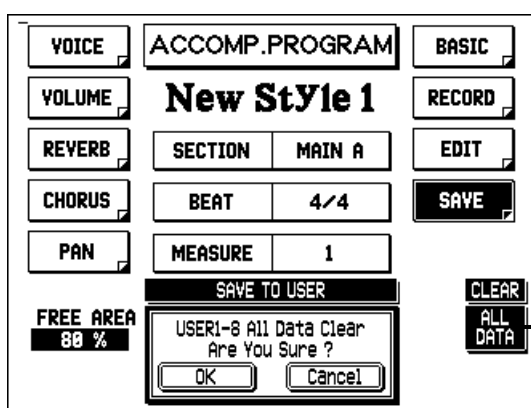

Clear All Data operation (see below).

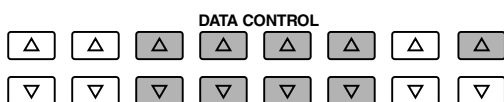

## 2. Select "OK" to clear all data (User Styles 1 - 8), or select "Cancel" to abort.

### HINT

Before using this function, you may want to save your important User Styles to floppy disk.

# Quitting Accompaniment Program

You can quit the Accompaniment Program function from any of its display pages.

To quit:

1. Press the ACCOMP. PROGRAM button in the DISPLAY SELECT section once again.

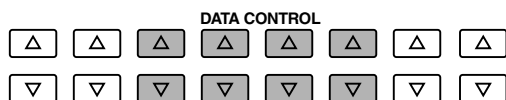
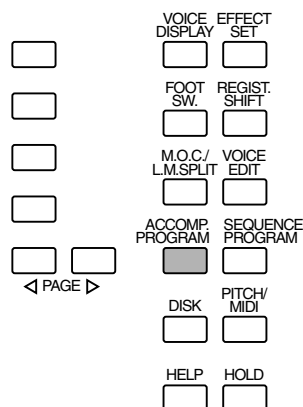

2. At the prompt, select "OK" to quit Accompaniment Program, or "Cancel" to continue editing.

## **NOTE**

Keep in mind that unlike in most other pages and functions, you cannot quit Accompaniment Program simply by pressing a different function's button in DISPLAY SELECT.

# Selecting and Playing User Styles

The User Styles you have created in Accompaniment Program can be selected and played from the panel Style buttons.

To select a User Style:

1. Press one of the dotted buttons in the STYLE section.

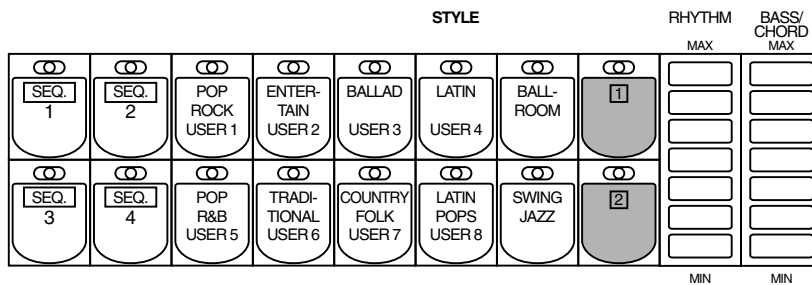

2. Select the USER page with the PAGE and Menu buttons.

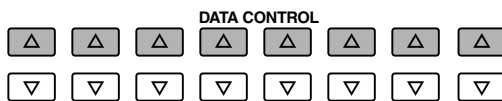

3. Select the desired User Style by pressing the appropriate Data Control button.

This assigns a User Style to the dotted button selected in step #1 above.

4. Press the START button in the ACCOMPANIMENT CONTROL section play the Style.

---

## ***Saving User Styles to Disk***

---

Once you have created your own User Styles, you'll want to save them to disk. Doing so allows you to free up memory in the AR-100 for creating additional Styles. Also, the User Styles you've saved to disk can be loaded back to the AR-100 any time.

User Style data is included in the bulk data that is saved when you record Registrations to disk. Refer to the section "Recording Registrations," page 95, for instructions.

---

## ***Loading User Styles from Disk***

---

The User Style data saved to disk as part of bulk data can instantly be loaded back to the AR-100. Refer to the section "Recalling Recorded Registrations," page 96, for instructions.

---

### ***NOTE***

---

When loading your original User Style data back to the AR-100, be sure to stop the Accompaniment if it is playing. Loading cannot be executed when a Accompaniment is running.

---

# Sequence Program

The Sequence Program function lets you connect any of the AR-100's Styles — as well as your own original User Styles, created in Accompaniment Program (page 122) — to create complete rhythm/accompaniment compositions. Individual sections, such as Intro, Fill In, and Ending can also be entered. You can create up to four of these sequences, which you can play back and perform along with. Of course, you can use the A.B.C. automatic accompaniment features with these Style sequences as well. You can also save additional sequences to floppy disks, allowing you to create an unlimited library of sequences for future use.

## Calling Up the Sequence Program Function

To call up the Sequence Program function:

1. Press the **SEQUENCE PROGRAM** button in the **DISPLAY SELECT** section.

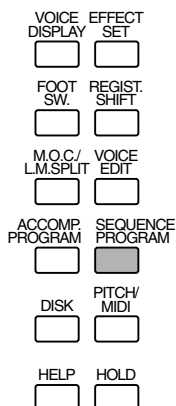

### **NOTE**

- Pressing the SEQUENCE PROGRAM button to enter the Sequence Program function automatically stops playback of Styles or User sequences.
- Use of the playback and recording functions on the Music Disk Recorder automatically cancels the Sequence Program operations.

The LEDs of the numbered Sequence buttons in the STYLE section on the panel will flash and the following display will prompt you to select a sequence number.

**Select a Sequence!!**

## 2. Press one of the numbered Sequence buttons to call up the Sequence display.

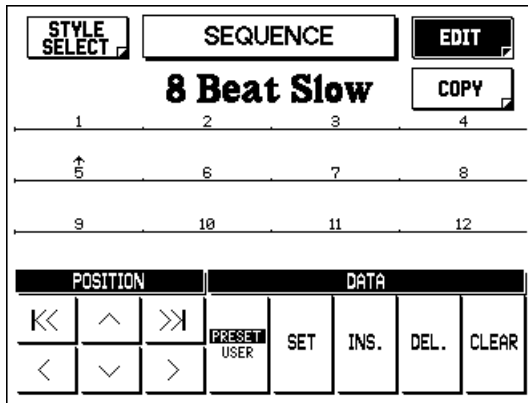
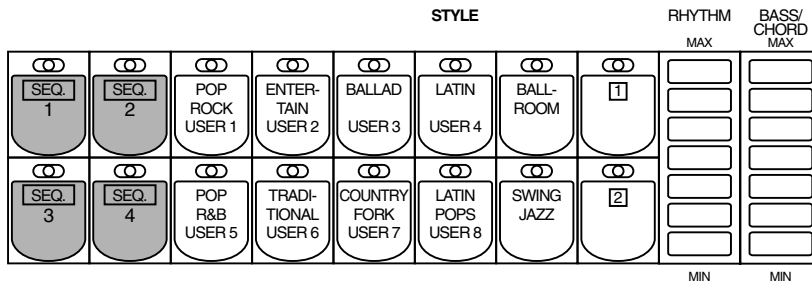

## Creating a Sequence Program

### 1. Select the EDIT page.

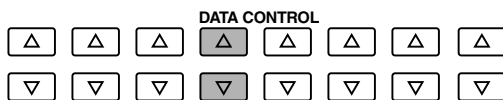
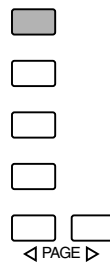
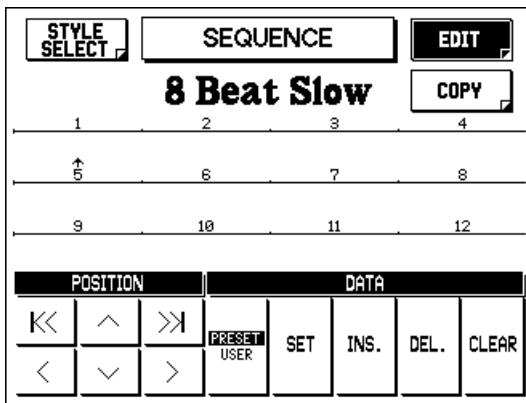

### 2. Select PRESET or USER, for the type of Style to be entered. Use the appropriate Data Control buttons.



### 3. Select the STYLE SELECT page.

Use the corresponding Menu button.

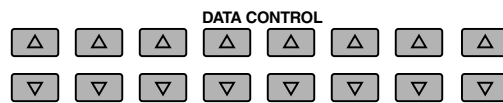
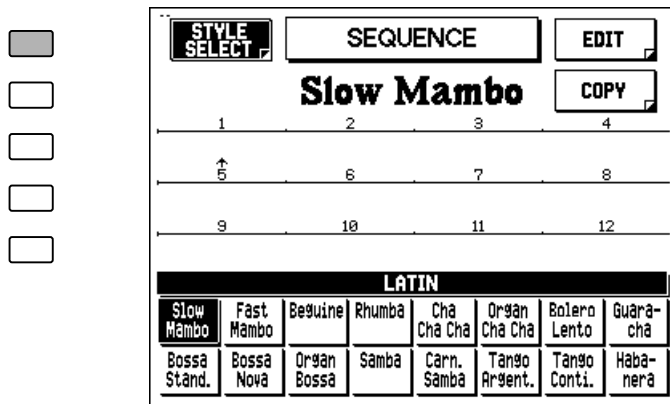

### 4. Press a Style button, and select a Style from the Style menu, if desired.

Pressing a Data Control button in this situation selects the corresponding Style and automatically returns to the EDIT page.

#### ***Easy Method for Selecting User Styles***

*You can directly select User Styles from the EDIT page by selecting USER in the display, then pressing one of the appropriate STYLE buttons (the ones labeled USER 1 - 8 in green).*

## 5. From the EDIT page, press the appropriate Data controls to set, insert, delete or clear the data as needed.

In this display, different Styles and sections can be entered in sequence along the pattern row in the middle of the display. Entered Styles/sections are shown in boxes, while the numbers in the row above indicate the position. Each position or box in the row corresponds to one measure, and each sequence has a maximum of 120 measures.

### **Entering Sections to a Sequence**

*Individual sections of a Style can also be entered to a sequence. An Intro section can only be entered at the beginning of a sequence. Similarly, entering an Ending section automatically defines the end of a sequence.*

#### **To enter sections:**

**Hold down the ACCOMPANIMENT CONTROL button corresponding to the desired section and simultaneously press the Data Control button corresponding to SET or INS. (Insert) in the display.**

*The selected section of the selected Style is entered to the sequence.*

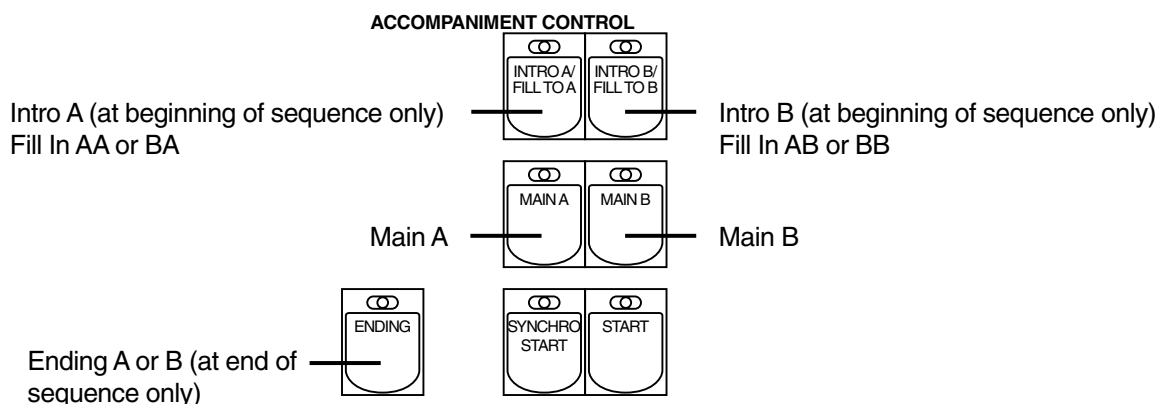

*The entered sections are indicated by abbreviations in dark boxes:*

- IA — Intro A
- IB — Intro B
- MA — Main A
- MB — Main B
- FA — Fill in AA or BA
- FB — Fill in AB or BB
- E — Ending A or B

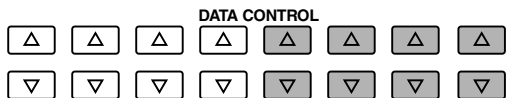
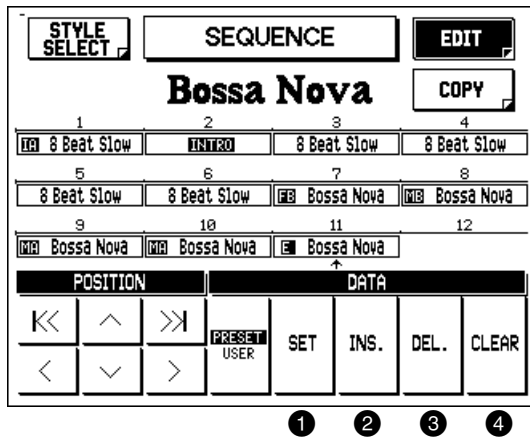

**1 SET**

This enters the selected Style to the current cursor position, replacing the previous entry, and automatically moves the cursor arrow to the next position.

**2 INS. (Insert)**

Inserts the selected Style to the current cursor position, and displaces all other Styles (including the one previously at the cursor position) to the right. Unlike with Set above, the cursor arrow stays at the same position.

**3 DEL. (Delete)**

Deletes the Style at the current cursor position.

**4 CLEAR**

Erases all entered Styles in the sequence. (At the subsequent prompt, select "OK" to clear the data, or "Cancel" to abort the operation.)

**6. Use the Position controls to select the position in the row, then edit the data as needed (as in step #5, above).**

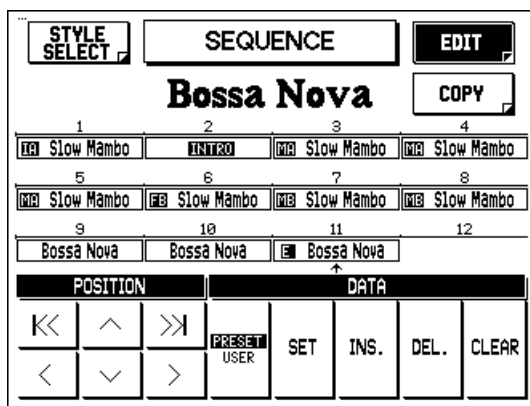

- ◀◀ Jumps to the beginning of the sequence.
- < Moves the cursor arrow one position to the left.
- ^ Moves the cursor arrow one row up.
- v Moves the cursor arrow one row down.
- ▶▶ Jumps to the end of the sequence.
- > Moves the cursor arrow one position to the right.

***Auditioning the Sequence***

You can play the Sequence at any time during the editing process by moving the cursor to the point at which you wish to begin playback and pressing the START button.

# Copying Sequence Data

This function allows you to copy the data stored at one Sequence button to another.

1. Call up the Sequence Program function by pressing the SEQUENCE PROGRAM button, and press the SEQ. (Sequence) button corresponding to the sequence you wish to copy.

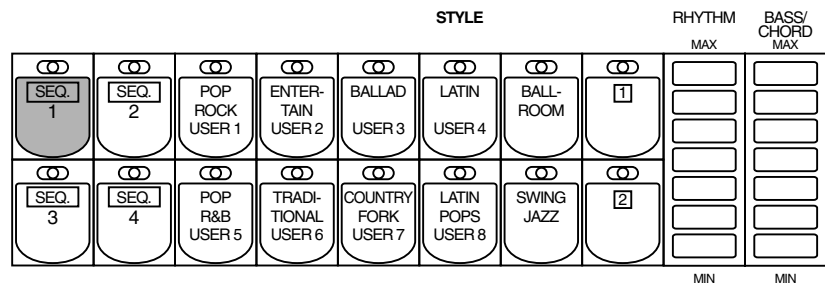
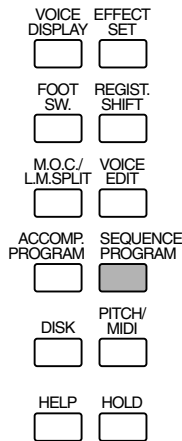

2. From the Sequence Program pages, select the COPY page with the appropriate Menu button.

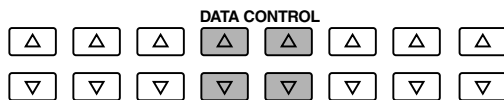
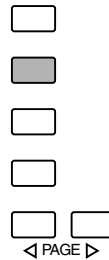
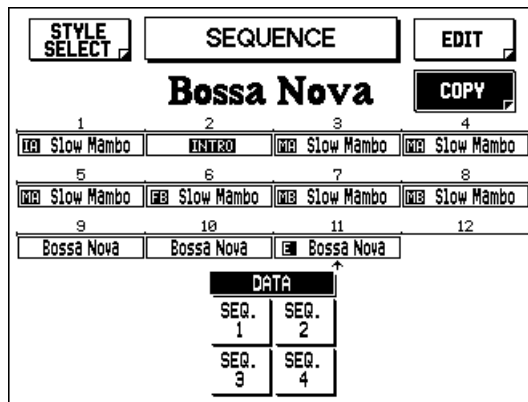

3. Press the Data Control button corresponding to the desired SEQ. (Sequence) number.

The data of the sequence you selected when entering Sequence Program will be copied to the button selected here.



If you are recording each section of a User Style separately (i.e., over several sessions), select that User Style each time you record new data to it, and always save it to the same User number.

- At the prompt, select "OK" to copy, or "Cancel" to abort the operation.

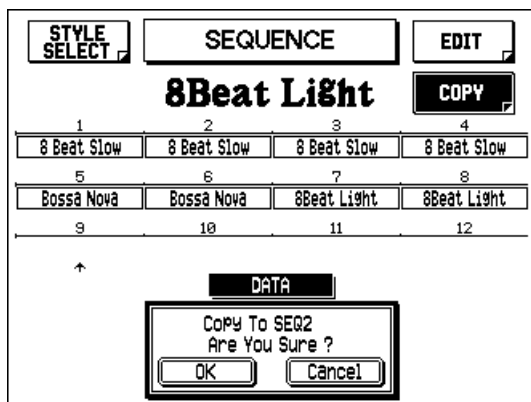

## ***Saving the Sequence and Quitting Sequence Program***

The edited Sequence is automatically saved when you quit the Sequence Program function. To save and quit, simply press the SEQUENCE PROGRAM button in the DISPLAY SELECT section again. (The button's lamp turns off and the display returns to the Voice Display.)

## ***Playing Sequences***

To play any of the Sequences you have created:

- Press the desired SEQ. (Sequence) button on the panel.

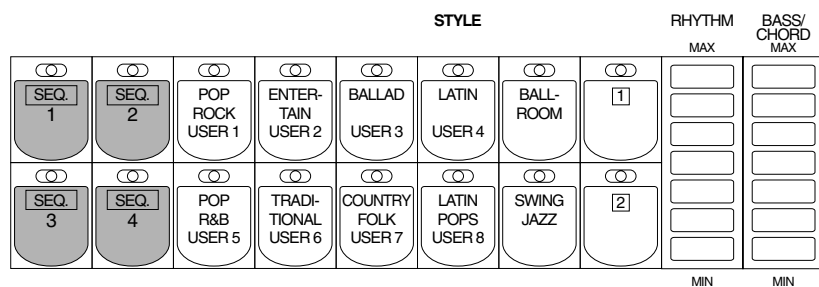

- Press the **START** button, or press **SYNCHRO START** and start the Sequence by playing the Lower keyboard or Pedalboard.

During playback of a Sequence, the lamps of the STYLE buttons light to indicate which Style is currently playing.

---

## ***Playing All Sequences in Order***

---

You can also automatically play back up to all four Sequences in order, one after the other.

**To do this:**

- 1. Press the desired Sequence buttons, making sure that their LEDs are all lit.**
- 2. Press the START button, or press SYNCHRO START and start the Sequence by playing the Lower keyboard or Pedalboard.**

The Sequences start from the lowest number and play in order automatically to the highest number. (For example, if you press Sequence buttons 4, 2 and 1 in that order, the Sequences will be played back in their numeric order: 1, 2, then 4.) This function effectively allows you to make a long Sequence that exceeds the 120-pattern memory limit of a single Sequence.

---

## ***Saving Sequence Data to Disk***

---

Once you have created your own sequences, you'll want to save them to disk. Doing so allows you to free up memory in the AR-100 for creating additional sequences. Also, the sequences you've saved to disk can be loaded back to the AR-100 any time.

Sequence data is included in the bulk data that is saved when you record Registrations to disk. Refer to the section "Recording Registrations," page 95, for instructions.

---

## ***Loading Sequence Data from Disk***

---

The sequence data saved to disk as part of bulk data can instantly be loaded back to the AR-100. Refer to the section "Recalling Recorded Registrations," page 96, for instructions.

---

### ***NOTE***

---

When loading your original Sequence Program data back to the AR-100, be sure to stop the Style if it is playing. Loading cannot be executed when a Style is running.

---

# Footswitches and Knee Lever

These leg- and foot-operated controls allow you to turn on and execute various performance functions without taking your hands from the keyboards.

## Footswitches

The AR-100 has two footswitches on the expression pedal that can be used to control various functions. The right footswitch is used for the Registration Shift functions (see page 76). The left footswitch can be set to control one of the following functions: Glide, Tremolo, or certain Style playback operations.

Assignments of the functions are made in the Foot Switch pages.

**To set the footswitch functions:**

- 1. Call up the Footswitch page by pressing the FOOT SW. button.**
- 2. Select the mode (OFF, RHYTHM, GLIDE, or TREMOLO) and make the desired settings.**

### FOOT SWITCH LEFT page

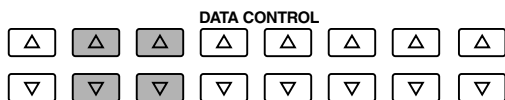
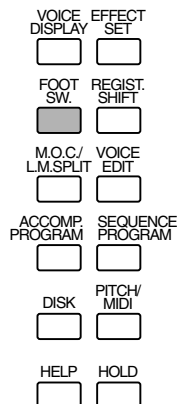
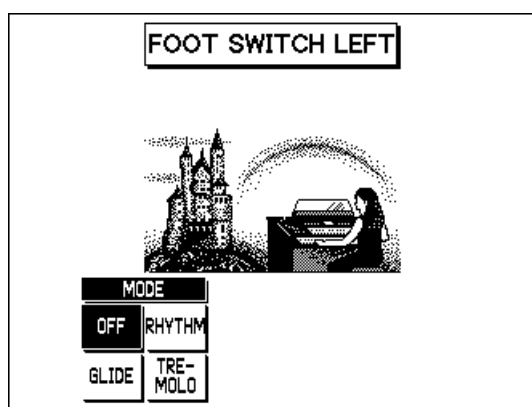

### **OFF**

Cancels left footswitch control.

# ***RHYTHM***

Selection of left footswitch control over Style functions. When this is chosen, the following display appears:

## **FOOT SWITCH LEFT Page — Rhythm**

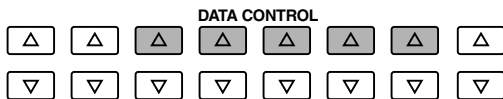
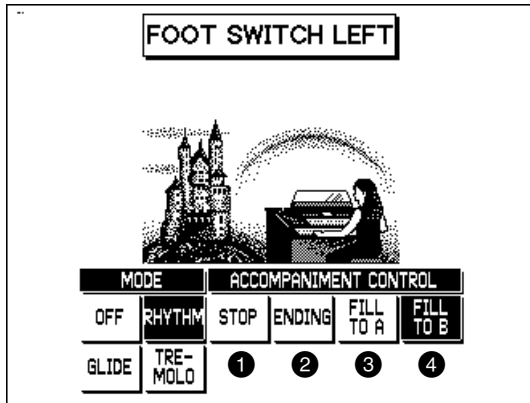

One of the four Accompaniment Control functions can be selected. Pressing the footswitch during accompaniment (Style) playback executes the selected function.

### **1 STOP**

Functions as an on/off switch for the accompaniment.

### **2 ENDING**

Switches the accompaniment to the Ending pattern, after which the accompaniment is stopped.

### **3 FILL TO A**

Plays the Fill In section, and immediately switches to the Main A section.

### **4 FILL TO B**

Plays the Fill In section, and immediately switches to the Main B section.



# GLIDE

Selection of footswitch control over Glide. Press the footswitch to immediately lower the pitch of the selected Voice or Voices by a halfstep, and release it to slowly return the pitch to normal. When the Glide setting is chosen, the following display appears:

## FOOT SWITCH LEFT Page — Glide

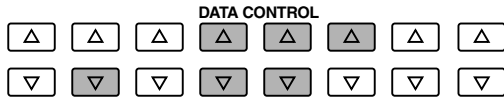
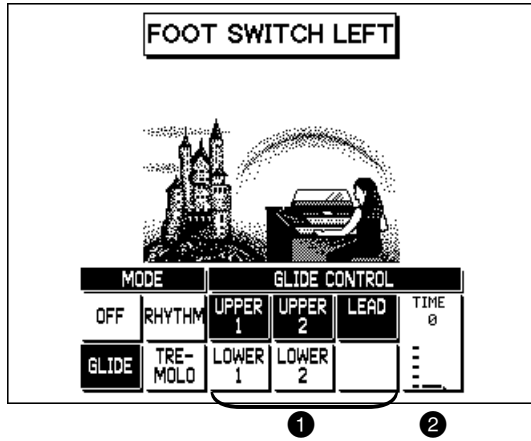

## GLIDE CONTROL

### 1 Voice Sections

The Glide function can be applied to any or all of the Voice sections shown in the display: Upper 1 and 2, Lead, Lower 1 and 2. Select the desired Voice section(s).

### 2 TIME

Determines the speed of the Glide function, or in other words, how gradually the pitch returns when the footswitch is released. Higher settings produce slower pitch changes. Range: 0 – 4

#### **NOTE**

When the Glide function is applied, Vibrato is not effective.

## **TREMOLO**

This enables footswitch control over the Tremolo effect. When TREMOLO is selected here, pressing the footswitch turns the Tremolo effect on and off, performing the same function as the TREMOLO button.

To use this function, the Tremolo effect must be properly set. (See page 39 for more information.)

### **FOOT SWITCH LEFT Page — Tremolo**

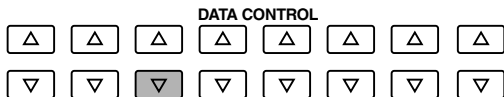

---

## ***Knee Lever***

---

The knee lever, located on the underside of the keyboard panel, can be used to turn on and off the Sustain effect, Melody On Chord function or Lead Slide effect.

### ***Sustain Control***

To select knee lever control over Sustain:

- 1. Make sure that the Upper and/or Lower Sustain effect panel controls have been turned on; otherwise the knee lever will have no effect.**

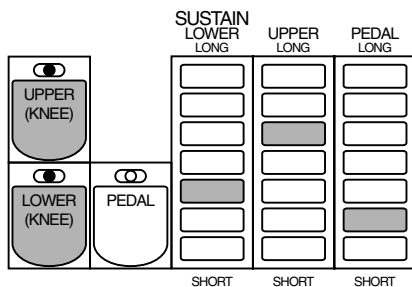

- 2. Fold the knee lever down.**

3. Press the knee lever to the right with your knee when you want to have sustain.

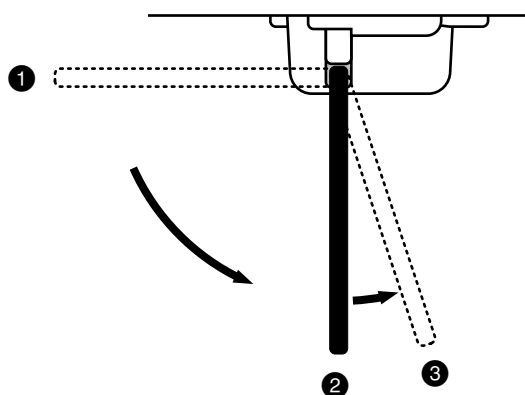

- 1 When the knee lever is folded up, Sustain is applied constantly, as long as the front panel SUSTAIN buttons are on.
- 2 When the knee lever is vertical, Sustain is off.
- 3 When the knee lever is pressed and held to the right, SUSTAIN is on.

## ***Melody On Chord Control***

To select knee lever control over Melody On Chord:

1. Call up the MELODY ON CHORD page.

To do this, press the M.O.C./L.M. SPLIT button in the DISPLAY SELECT section, then select the M.O.C. page.

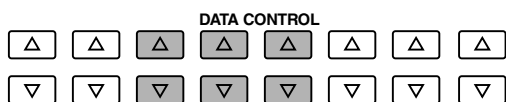
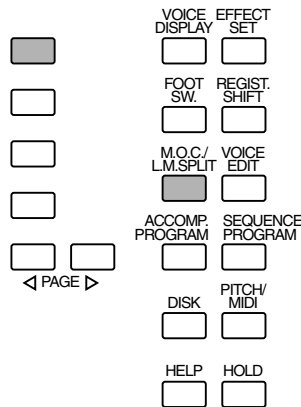
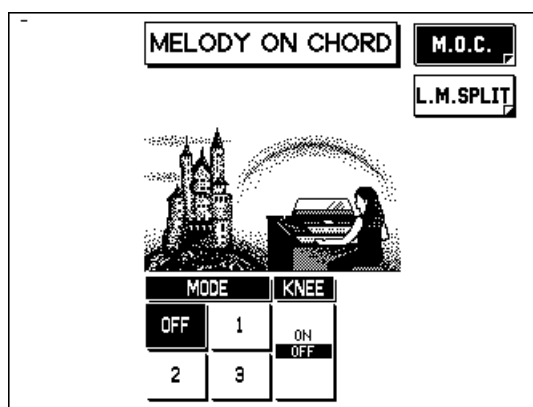

2. Make sure that one of the Melody On Chord modes have been selected (1, 2, or 3).

3. Set the Knee setting to "ON."

4. Press the knee lever continuously to the right to produce the Melody On Chord effect as you play.

### **NOTE**

When the KNEE parameter is set to "ON," Melody On Chord can only be applied by using the knee lever.

## ***Lead Slide Control***

To select knee lever control over Lead Slide:

### **1. Call up the LEAD VOICE - VIBRATO Page.**

To do this, press the desired Lead Voice button twice (to call up the Lead Voice Condition page), then select the VIBRATO page with the appropriate Menu button.

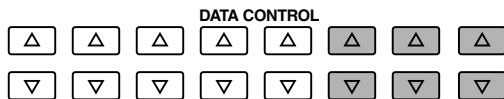
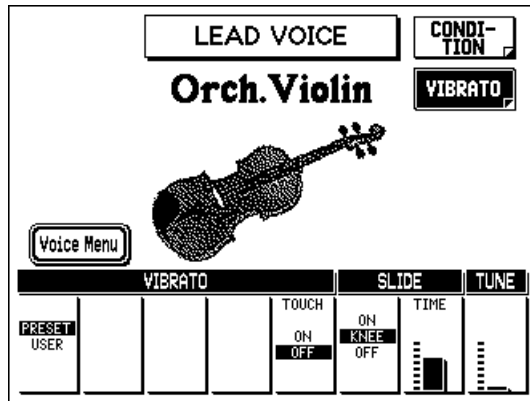

### **2. Make sure that the Slide Time is set to a value other than 0, and set the Slide control to "KNEE."**

### **3. Press the knee lever continuously to the right to produce the Lead Slide effect as you play.**

#### **NOTE**

If the KNEE parameter is selected, Lead Slide can only be applied by using the knee lever.

# Accessory Jacks and Controls

The AR-100 is equipped with various input/output terminals and miscellaneous controls, the functions of which are described below.

## Underside of Keyboard

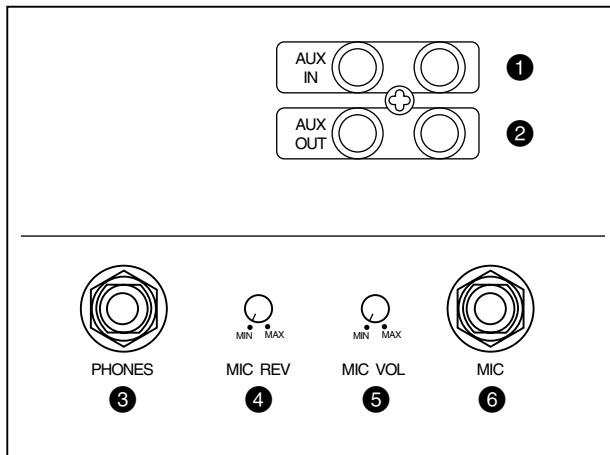

### ① AUX IN jacks (RCA)

For connection of another sound source (CD player, tone generator, etc.). The sound is mixed with the sound of the AR-100 and played through the built-in speakers.

### ② AUX OUT jacks (RCA)

For connection to an external mixer, recorder, or amplifier/speaker system. Use these in recording or live performance applications.

### ③ PHONES jack

For connection of a stereo headphone set. The built-in speakers are automatically turned off when this is connected.

### ④ MIC REV (Microphone Reverb)

For adjusting the amount of Reverb effect applied to the microphone input.

### ⑤ MIC VOL (Microphone Volume)

For adjusting the level of the microphone input.

### ⑥ MIC (Microphone) jack (1/4" phone)

For connection of a microphone.

## Rear Panel

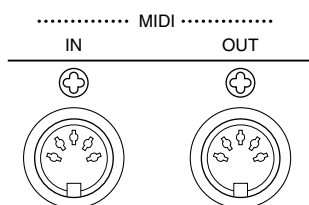

### MIDI IN/OUT terminals (rear panel)

For connection to MIDI instruments and devices. (See page 162 for more information.)

# Pitch Controls

There are two overall pitch-related controls on the AR-100: Transpose and Pitch. Transpose allows you to change the key of the instrument and Pitch lets you finely adjust the tuning. These features make it easy to change the key of a song to accommodate a vocalist's range or to precisely match the tuning of another instrument.

## To set Transpose and Pitch:

1. Press the **PITCH/MIDI** button in the **DISPLAY SELECT** section, then press the appropriate **Menu** button to call up the **PITCH** page.

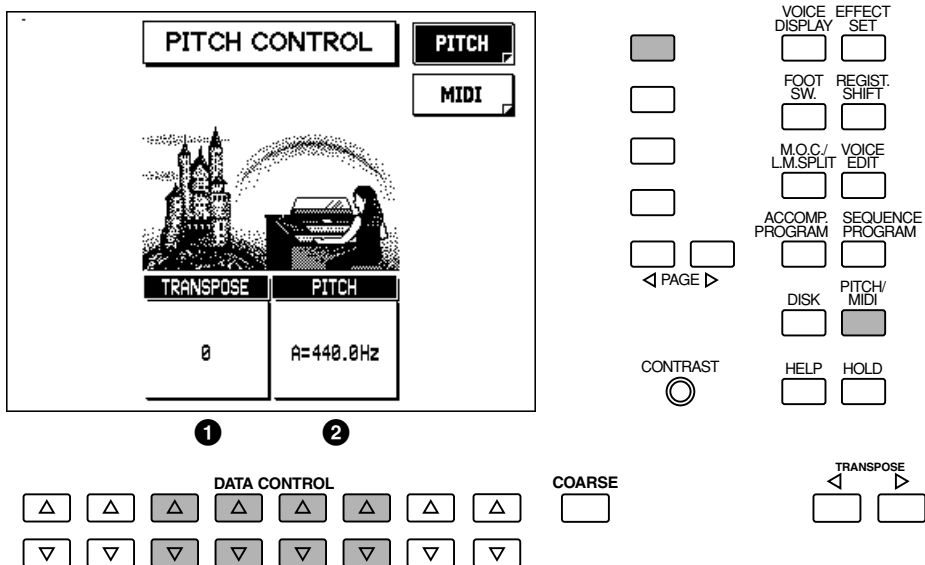

2. Adjust the settings with the appropriate **Data Control** buttons.

### 1 TRANSPOSE

Determines the coarse pitch setting of all the voices, and is adjustable in half-steps (semitones). Range: -6 – +6 (one octave)

### 1 PITCH

Determines the fine pitch setting of all the voices.  
Range: 414.6 – 466.8Hz

## TRANSPOSE Buttons

Transpose can also be set from the panel, with the TRANSPOSE  $\triangleleft/\triangleright$  buttons. Press TRANSPOSE  $\triangleright$  to raise the Transpose setting by a half-step, and press TRANSPOSE  $\triangleleft$  to lower it.

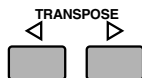

The current Transpose setting is shown in the Voice Display.

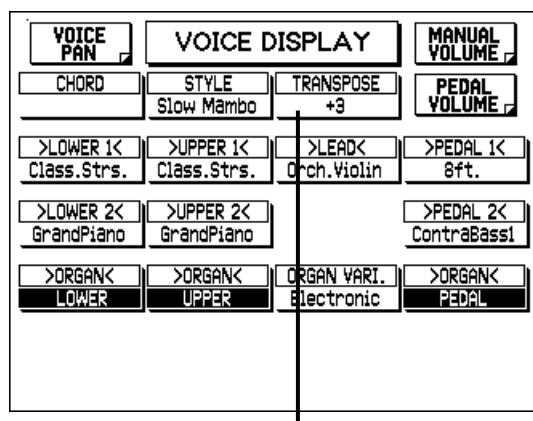

Current Transpose setting.

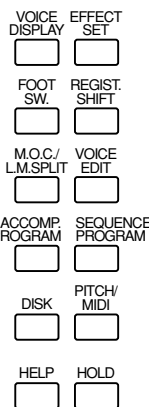
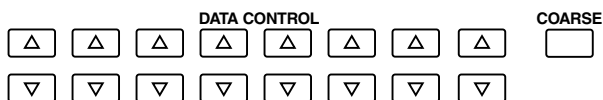

### NOTE

- The default Pitch setting is 440.0Hz (at A3).
- Pitch changes cannot be recorded to the Music Disk Recorder.

### HINT

When tuning the AR-100 to match the pitch of another instrument, use the Clarinet voice on the Lower keyboard, and make sure that effects such as Tremolo or Symphonic are turned off.

## About the Pitch of the Voice Sections

The various Voice sections and sounds of the instrument are set to different pitches (as shown below).

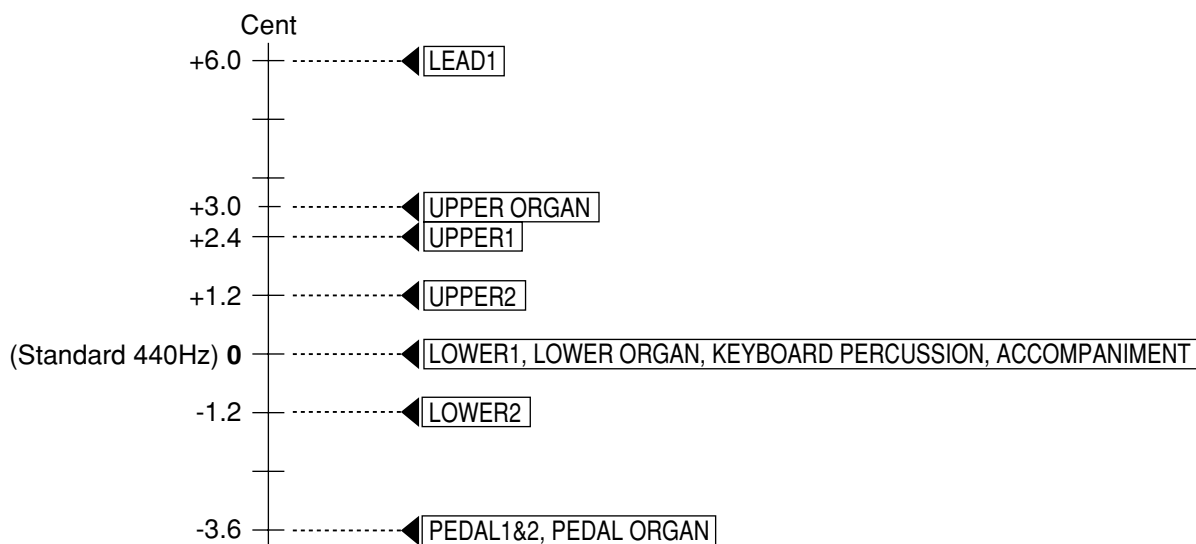

# MIDI

MIDI (Musical Instrument Digital Interface) is a worldwide standard that allows virtually all modern electronic instruments to communicate with each other and control each other's functions. For example, you could play different sounds on a connected synthesizer from the keyboards of the AR-100. In another application, a rhythm machine can be programmed to play its rhythms in perfect synchronization with the tempo set on the Electone.

For two MIDI instruments to properly communicate with each other, they must be connected by MIDI cables. In a very basic example, the MIDI OUT terminal on the AR-100 (on the rear panel) could be connected to the MIDI IN of a MIDI keyboard or tone generator, allowing you to play the sounds on the connected device from the keyboards of the AR-100.

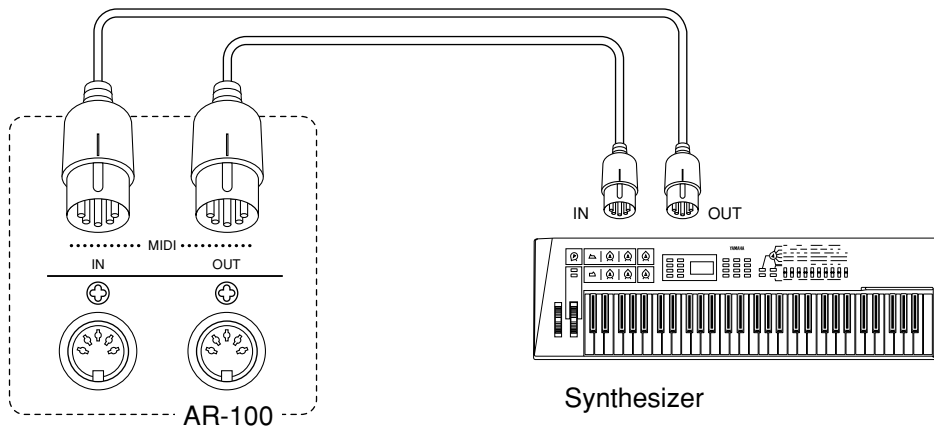

Connect the MIDI IN of the AR-100 (on the rear panel) to the MIDI OUT of the other device, and connect the MIDI OUT of the AR-100 to the MIDI IN of the device.

The instruments communicate with each other by sending "messages" or MIDI data. These messages are transmitted over one of sixteen different MIDI channels. Provided the MIDI channels are set properly and provided the connected instrument has "multi-timbral" capability, you can play separate sounds on the instrument from each keyboard and Pedalboard of the AR-100.

Similarly, by connecting the MIDI IN terminal of the AR-100 to the MIDI OUT of another device (such as a keyboard or sequencer) and setting the proper MIDI transmit and receive channels, you can play the Voices of the AR-100 from that device.



## To select the MIDI page:

Press the PITCH/MIDI button in the DISPLAY SELECT section, and select the MIDI page by pressing the appropriate Menu button.

## MIDI CONTROL Page

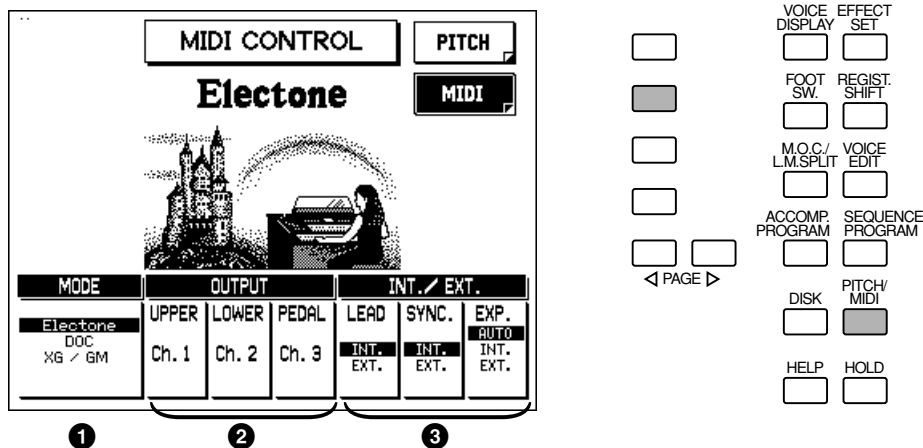

### 1 MODE

Determines the MIDI operating mode of the AR-100. This should be set to match the connected MIDI device to ensure proper MIDI control and response.

- **Electone**

Select this setting when using the AR-100 with another Electone. (This is the default setting.)

- **DOC**

Select this setting when using the AR-100 with instruments compatible with Disk Orchestra Collection (D.O.C.) software. The Mode automatically changes to DOC when a "DOC On" MIDI message is received, or when a D.O.C. disk has been inserted in the M.D.R. disk slot.

- **XG/GM**

Select this setting when using the AR-100 with XG- and GM-compatible devices. The Mode automatically changes to XG/GM when a "XG On" or "GM On" MIDI message is received, or when a XG or GM disk has been inserted in the M.D.R. disk slot.

#### **NOTE**

The A.B.C. accompaniment features of the AR-100 cannot be used when the Mode is set to DOC or XG/GM.

### 2 OUTPUT (UPPER, LOWER, PEDAL)

Determines the channels over which MIDI data is sent, for each keyboard. To restore the default setting for each of these parameters, press both of the corresponding Data Control buttons ("up" and "down" buttons) simultaneously.

### ③ INT./EXT. (Internal/External)

- **LEAD**

Determines internal or external control of the Lead Voice. When set to Internal, the Upper keyboard plays the Lead Voice. When this is set to External, a connected MIDI instrument can play the Lead Voice (over channel 4).

- **SYNC.**

Determines the timing control source, when using external rhythm machines, sequencers, etc. Setting this to Internal gives timing control to the AR-100. Setting this to External gives timing control to the external device.

- **EXP. (Expression)**

Determines the control of the expression pedal. Ordinarily, this should be set to AUTO. (In AUTO, playback of the M.D.R. automatically switches the setting to EXT. to allow MD.R. control over the expression pedal.) When it is set to INT., you can manually control the expression pedal functions during M.D.R. playback. When it is set to EXT., the M.D.R. (or a second, connected Electone) controls the expression pedal functions.

### About the Receive Channels

When using another MIDI device to play the Electone's voices, you must set the MIDI transmit channel(s) of the connected device to match the receive channel(s) of the Electone. The MIDI receive channels of the Electone are fixed to the following values:

Upper= 1

Lower= 2

Pedal= 3

The MIDI transmit channel of each connected MIDI device should match the above numbers.

---

**NOTE**

---

Accompaniment pattern sounds cannot be controlled via MIDI.

---

# Appendix

---

## Troubleshooting

---

### **GENERAL OPERATION**

- **No sound is produced from the Electone's speakers.**  
The plug of the cable from the speaker unit is disconnected. Refer to the separate "Assembly Instructions," and reconnect the plug securely.
- **A cracking noise is sometimes heard.**  
Noise may be produced when either an electrical appliance is turned on or off, or an electric power tool (such as drill) is used in the proximity of the Electone. If this occurs, plug the Electone into an electrical outlet located as far as possible from the device that seems to be the source of the problem.
- **Interference from radio, TV, or other sources occurs.**  
This is caused by the proximity of a high-power broadcasting station or amateur ham radio setup.
- **The sound of the Electone causes surrounding objects to resonate.**  
Because the Electone is capable of producing powerful bass sounds, resonance may be caused in surrounding objects, such as cabinets or glass windows. To avoid this, relocate the objects or lower the Electone's volume.
- **The Electone panel does not function normally or the content of the memorized data has changed.**  
This happens very rarely. Occasionally, power surges and spikes due to electrical storms or other reasons may cause the Electone to malfunction and/or alter the contents of memorized data. If this happens, use the Power On Reset operation to reset the Electone. (See page 79.)
- **The display doesn't change as expected when changing functions.**  
Make sure the HOLD button is not lit. (See page 14.) Also, depending on the function selected (for example, Voice Edit, Accompaniment Program, or Sequence Program), a different function cannot be selected.

### **VOICES/STYLES**

- **When selecting a dotted button Voice or Style, the Voice or Style title at the top of the display does not match the Voices or Styles.**  
The currently assigned Voice or Style is displayed at the top of the display, and remains until another Voice or Style has been selected. (See pages 20, 53.)
- **When many keys are pressed, not all of the notes sound.**  
This happens very rarely. The total simultaneous polyphonic capacity of the AR-100 (including all Voice sections, accompaniment, etc.) is 128 notes. If this is exceeded, notes may be cut off or not sound.
- **The Lead Voice or Pedal Voice cannot be played from the Upper Keyboard or Pedalboard, respectively.**  
Make sure that the To Lower function is off for the respective Voice section. (See page 18.)

- **When playing a Pedal Voice from the Lower Keyboard (using the To Lower function), pressing the Lower Keyboard's Sustain button does not turn on Sustain.**  
Even though the Pedal Voice is being played from the Lower Keyboard, it is still a Pedal Voice; turn the Sustain on with the Pedal Sustain button.
- **The sound is too soft, despite the volume being set to the maximum.**  
First check that the appropriate Voice sections are turned on in the ENSEMBLE section. (See page 18.) Also check all of the volume controls, making sure that they are set to suitable levels: the panel Volume controls for each Voice section, the MASTER VOLUME dial, and the Expression Pedal. (See pages 7, 17.) Also check the MANUAL BALANCE control. (See page 18.)
- **Switching Voices causes the volume to change, despite their having identical volume settings.**  
The volume of certain Voices may seem lower than that of others. Adjust the balance of the sound with the Volume control within the appropriate Voice Condition display.
- **The Click sound cannot be heard.**  
Make sure that the Click Volume is set to an appropriate level (in the FLUTE VOICE page).
- **The Initial Touch and After Touch functions do not seem to have any effect on the sound.**  
Adjust the Touch Tone settings in the Voice Condition display. (See page 33.)
- **When keys on the Lower Keyboard or Pedalboard are pressed, the sounds of percussion instruments are also heard.**  
The Keyboard Percussion function has been turned on. When not using the function, be sure to turn it off. (See page 61.)
- **Only one sound is heard when two notes of the Lead or Pedal Voices are simultaneously played.**  
For practical performance reasons, the Electone has been designed so that one note of the Lead or Pedal Voices can be played at a time. If several keys are pressed at once, only the highest note will be sounded (highest-note priority).
- **The Style doesn't change, even when changing Registrations.**  
Make sure that the D. (Disable) buttons are not lit. (See page 61.)
- **Even though a dotted button's Style has been selected and started, the pattern does not sound.**  
If the dotted button contains a User Style that has no recorded data, the Style will not sound. Select a Style that contains recorded data.

## **ACCOMPANIMENT**

- **The A.B.C. accompaniment does not function.**  
A.B.C. accompaniment is automatically disabled when the MIDI Mode is set to DOC or XG/GM, or when a D.O.C. or XG/GM disk has been inserted in the M.D.R. disk slot. (See page 163.)
- **Bass and chord accompaniment cannot be heard**  
Make sure that the Bass/Chord level is set appropriately. (See pages 24, 51.)
- **The Pedal Voices do not sound, even though the volume is properly set.**  
This is normal for the Single Finger and Fingering Chord modes of Auto Bass Chord. Set the A.B.C. mode to Off. (See pages 55, 60.)

- **The accompaniment and/or rhythm suddenly stops when releasing keys on the Lower keyboard or Pedalboard.**  
Depending on the A.B.C. mode and Memory settings, you can stop the accompaniment and/or rhythm by releasing the keys. (See page 60.)
- **While an Intro or Ending pattern is automatically playing, the Lower Keyboard does not produce any sound, even when the keys are played.**  
Since the Accompaniment chords play automatically one after another, the Lower Keyboard Voices are designed not to sound during the playback of an Intro or Ending pattern.
- **The Fill In doesn't play properly.**  
Make sure to press the FILL TO A or FILL TO B buttons precisely at the point you wish the Fill In to begin. If you press the button too late, only part of the Fill In may play, or it may not play at all.
- **The pitch in the Single Finger mode does not change, even when pressing different keys of the keyboard.**  
Single Finger mode will only produce notes when played within a fixed octave interval on the Lower Keyboard. If notes with the same letter name are pressed outside of that range, the chords that are sounded will share the same pitch.
- **The harmony notes of the Melody On Chord function cannot be heard.**  
The Upper Keyboard has been set to sound only Lead Voices. Make sure that one of the Upper Keyboard Voice sections (1, 2 or Organ) has been turned on and that the volume setting is appropriate.

## **EFFECTS**

- **The Tremolo, Symphonic/Celeste, Flanger, and Delay effects cannot be heard, even when they are turned on in the Voice Condition page.**  
Make sure that the corresponding effects are set to appropriate values in the EFFECT SET pages. (See page 37.)
- **The Tremolo, Symphonic/Celeste, Flanger, and Delay effects cannot be heard, even when they are set in Effect Set.**  
Effects must be turned on in the Voice Condition page. (See page 34.)
- **The Tremolo effect cannot be heard, even when the TREMOLO (FAST) button.**  
Tremolo must be selected first in the Voice Condition display (for panel Voices), or in the FLUTE VOICE or EXTRA VOICE pages (for the Flute/Tibia and Extra Voice sections). (See pages 28, 31, 34.)
- **The Pan function does not operate.**  
The Pan function can only be used if all other effects in the Voice Condition page are set to off. (See page 34.)
- **The Reverb effect does not operate, even when Reverb parameters are increased.**  
Increase the Reverb on the panel Reverb touch control, or increase the Reverb Depth in the REVERB page.
- **Sustain has no effect on the Lead Voices.**  
This is normal; Sustain cannot be applied to the Lead Voices.

## **REGISTRATION MEMORY**

- **Certain functions have not been memorized to Registration Memory.**  
Transposition and Pitch control data, among others, cannot be memorized (except as song data). (See page 73.)

## **VOICE EDITING**

- **During Voice editing, the specified Voice isn't heard, even when the keyboard is played.**  
The current settings may be preventing the Voice from sounding. Make sure that the Voice section is turned on (in ENSEMBLE section) and that the volume of the Voice is set to a suitable level. Also, adjust the various parameters in Voice Edit until the Voice can be heard.
- **The Repeat function seems to turn off the selected Voice.**  
Some Voices may not sound properly if the Speed parameter (in Repeat) is set too high. (See page 116.)
- **The Voice sounds strange or doesn't sound at all when setting Resonance.**  
The effect of the Resonance setting varies depending on the selected Voice. (See page 116.)

## **MUSIC DISK RECORDER**

- **Recording or playback cannot be performed.**  
The PLAY or RECORD section buttons for selecting parts may be turned off. Turn on the appropriate PLAY or RECORD buttons.
- **A total of 40 songs cannot be recorded.**  
If some song numbers contain a large amount of recorded data, the disk may not have enough available memory left to record the normal maximum of 40 songs.
- **Recording is stopped before the performance is finished, or the Song Copy function cannot be executed.**  
The amount of recorded data on the disk is close to the maximum limit. Either use another disk or delete the data of any unnecessary song number.
- **The desired Style has not been recorded; either it doesn't play, or a different Style from the one recorded plays back.**  
The M.D.R. is designed so that the Style cannot be started at the very beginning of a recording. If you wish to use the Style, start it after the available memory display appears on the M.D.R. display.
- **The notes of the recording are "stuck" and sound continuously.**  
Avoid removing the disk by pressing the EJECT button during playback. Whenever you wish to stop playback, always press the STOP button.

# MIDI Implementation Chart

YAMAHA [ Electone-EL Mode ] / Model : AR-100

Date: 27-Aug-1996  
Version: 1.00

Function		Transmit	Receive	Remarks
Basic Channel	Default Changed	1, 2, 3, 16 (*1) 1-16	1, 2, 3, 15, 16 (*2) 4	
Mode	Default Messages Altered	Mode 3 × *****	Mode 3 × ×	
Note Number	: True voice	36-96 (*3) *****	13-96 (*4)	
Velocity	Note on Note off	○ 9nH, v = 1-127 ○ 9nH, v = 0	○ 9nH, v = 1-127 × 9nH, v = 0 or 8nH	PK=64 (Fixed)
After Touch	Key's Ch's	× ○	× ○	Except PK
Pitch Bender		×	×	
Control Change	1 4 11 64	× × ○ ×	× × ○ (*5) ×	Modulation Wheel 2nd Expression Pedal Expression Pedal Sustain
Program Change	: True number	○ 0-15, 32-47, 64-71 *****	○ 0-15, 32-47, 64-71 *****	(*6)
System Exclusive		○	○	
System Common	: Song Position : Song Select : Tune	× × ×	× × ×	
System Real Time	: Clock : Commands	○ ○	○ ○	(*5) (FAH, FCH)
Aux Messages	: Local On/Off : All Notes Off : Active Sense : Reset	× × ○ ×	× × ○ ×	

**Notes :**

- (\*1) ; 1ch: UK, 2ch: LK, 3ch: PK, 16ch: CONTROL
- (\*2) ; 1ch: UK, 2ch: LK, 3ch: PK, 4ch: LEAD, 15ch: KEYBOARD PERCUSSION, 16ch: CONTROL
- (\*3) ; UK: 48-96, LK: 36-84, PK: 36-55
- (\*4) ; 1-4ch: 36-96, 15ch: 13-84
- (\*5) ; Received only in External mode
- (\*6) ; 0-15: Registration Memory, 32-47: Orchestral Preset, 64-71: Organ Preset

Mode 1: OMNI ON, POLY  
Mode 3: OMNI OFF, POLY

Mode 2: OMNI ON, MONO  
Mode 4: OMNI OFF, MONO

○ : Yes  
× : No

# MIDI Implementation Chart

YAMAHA [ Electone-XG/GM/DOC Mode ] / Model : AR-100

Date: 27-Aug-1996

Version: 1.00

Function		Transmit (*1)	Receive	Remarks
Basic Channel	Default Changed	1, 2, 3, 16 1-16	1-16 1-16	
Mode	Default Messages Altered	Mode 3 X *****	Mode 3 X X	
Note Number	: True voice	36-96 *****	0-127 0-127	
Velocity	Note on Note off	<input type="radio"/> 9nH, v = 1-127 <input type="radio"/> 9nH, v = 0	<input type="radio"/> 9nH, v = 1-127 <input checked="" type="radio"/> 9nH, v = 0 or 8nH	
After Touch	Key's Ch's	X <input type="radio"/>	<input type="radio"/> (*2) <input type="radio"/>	
Pitch Bender		X	<input type="radio"/>	
	0, 32 1, 5, 7, 10 11 6, 38 64-67 71-74 84 91, 93, 94 96-97 98-99 100-101 120 121	X X <input type="radio"/> X X X X X X X X X X X	<input type="radio"/> <input type="radio"/> <input type="radio"/> <input type="radio"/> <input type="radio"/> <input type="radio"/> <input type="radio"/> <input type="radio"/> <input type="radio"/> <input type="radio"/> <input type="radio"/> <input type="radio"/> <input type="radio"/> <input type="radio"/>	Bank Select  Expression Data Entry  Sound Controller Portamento Cntrl Effect Depth RPN Inc, Dec NRPN LSB, MSB RPN LSB, MSB All Sound Off Reset All Cntrls
Program Change	: True number	<input type="radio"/> 0-15 *****	<input type="radio"/> 0-127 0-127	
System Exclusive		<input type="radio"/>	<input type="radio"/>	
System Common	: Song Position : Song Select : Tune	X X X	X X X	
System Real Time	: Clock : Commands	<input type="radio"/> <input type="radio"/>	X X	
Aux Messages	: Local On/Off : All Notes Off : Active Sense : Reset	X X <input type="radio"/> X	X X <input type="radio"/> X	
<b>Notes :</b> (*1) ; Same as EL Mode (*2) ; Only Note Number 36-97				

Mode 1: OMNI ON, POLY  
Mode 3: OMNI OFF, POLY

Mode 2: OMNI ON, MONO  
Mode 4: OMNI OFF, MONO

: Yes  
 : No



# Specifications

KEYBOARD	Keyboards	Upper: 49 keys (C-C), Lower: 49 keys (C-C), Pedal: 20 keys (C-G)
	Touch Tone	Initial, After (Upper, Lower)
VOICE	Tone Generation	AWM (Polyphony 128)
	Voices	205 Voice Menu Voices, Full set of Organ Voices (Flute/Tibia) with Attack/Chiff, Extra Voices
	Voices for Playback	XG/GM Voices, DOC Voices *Available only when each sequence data is received/played back
	Ensemble	On/Off: Upper Voice 1, 2, Lead Voice, Upper Organ (Flute/Tibia, Extra); Lower Voice 1, 2, Lower Organ (Flute/Tibia, Extra); Pedal Voice 1, 2, Pedal Organ (Flute/Tibia, Extra);
	Organ Variation	Theatre, Jazz, Electronic, Classical
VOICE CONTROL/EFFECT	Volume	Upper Voice 1, 2, Upper Flute/Extra, Lower Voice 1, 2, Lower Flute/Extra, Lead, Pedal Voice 1, 2, Pedal Flute/Extra: 0~24
	Feet	Upper Voice 1, 2, Lower Voice 1, 2, Lead, Pedal Voice 1, 2: 4', 8' 16'; Upper Extra (down), Lower Extra (up)
	Pan	Upper Voice 1, 2, Lower Voice 1, 2, Lead, Pedal Voice 1, 2: 7 Positions
	Brilliance	Upper Voice 1, 2, Lower Voice 1, 2, Lead, Pedal Voice 1, 2: -3~+3
	Vibrato	Upper Voice 1, 2, Lower Voice 1, 2, Lead: Preset/User (Delay*, Depth, Speed*); Touch Vib.* *for Lead
	Lead Slide	On, Knee, Off; Time
	Lead Tune	Lead
	Symphonic/Celeste	Upper Voice 1, 2, Upper Extra, Lower Voice 1, 2, Lower Extra, Lead, Pedal Voice 1, 2: Mode
	Delay	Upper Voice 1, 2, Lower Voice 1, 2, Lead, Pedal Voice 1, 2: Speed, Feedback, Balance
	Flanger	Upper Voice 1, 2, Lower Voice 1, 2, Lead, Pedal Voice 1, 2: Speed, Feedback, Depth
	Reverb	Upper Voice 1, 2; Lower Voice 1, 2; Lead; Pedal Voice 1, 2; Organ, K.B.P., Effects: Mode, Length, Depth
	Sustain	Upper, Lower, Pedal
	Tremolo	Upper Voice 1, 2, Upper Flute/Extra; Lower Voice 1, 2, Lower Flute/Extra; Lead, Pedal Voice 1, 2: Type, Speed, Chorus
VOICE EDIT	Repeat: All, Twin, Off; Speed; Output Level; Filter: Cutoff, Resonance; EG Rate: Attack, Decay, Release; Name; Save; User Voice 1-16	
MELODY ON CHORD	Mode: Off, 1, 2, 3; Knee: On/Off	
LOWER MANUAL SPLIT	On/Off: Left (Lower1, 2, Lower Organ; Octave Up); Right (Lower1, 2, Lower Organ); Key set	
ACCOMPANIMENT	Styles	160 Styles
	Sections	Intro A, B, Main A, B, Fill In AA, AB, BA, BB, Ending A, B
	Parts	Rhythm1, 2, Bass, Chord 1, 2, Pad, Phrase1, 2
	Auto Bass Chord	Mode: Off, Single Finger, Fingered, Custom ABC; Memory: Lower/Pedal
	Controls	Start, Syncro Start; Tempo; Bar/Beat LED; Rhythm Volume, Accompaniment Volume; Part: On/Off
KEYBOARD PERCUSSION	72 Assignable Drum/Percussion Sounds; On/Off; Lower(LK Preset/User1), Pedal(PK Preset/User2); Assign, Copy, Clear	
ACCOMPANIMENT PROGRAM	Basic: Section (Intro, Main A, Main B, Fill In, Ending), Beat (2/4, 3/4, 4/4, 5/4, other), Measure (1-8, other), Name, Metronome (On/Off); Record (Real Time Recording): Mode (Rec., Play, Mute, Delete), Part (Rhythm1, 2, Bass, Chord1, 2, Pad, Phrase1, 2); Edit: Part Copy, Part Quantize (  , Off ); Save: User Style1-8, Data All Clear; Voice; Volume; Reverb; Chorus; Pan	
SEQUENCE PROGRAM	Sequence 1-4; 120 Positions (Measures); Edit: Cursor Controls, Set, Insert, Delete, Clear; Copy	
DEMONSTRATION SONGS	24 Songs; Repeat: All, Random, Single, Off	
REGISTRATION MENU	384 Menus (Organ Preset, Orchestral Preset)	
REGISTRATION MEMORY	M./To Disk, 1-16; Disable Button; Initial Registration; Registration Shift: Off, Shift, Jump, User (80 Positions, Cursor Controls, Set, Insert, Delete, Clear)	
MUSIC DISK RECORDER	Disk Type: Electone, XG/GM, DOC; LED display; Eject; Page Up/Down Control Panel: Play/Record Part (All, Lower, Upper, Pedal, K.B.P., Control), Stop, Play, Song Select, Record, Custom Play, Retry, Pause, Rewind, Fast Forward, Tempo; Repeat Play: Off, All Repeat, Random Repeat, Single Repeat; Utility: Disk Format, Disk Copy, Song Copy, Song Delete, Name, Remaining Memory	
PITCH	Pitch, Transpose	
MIDI	Mode: Electone, XG/GM, DOC; Output: Upper, Lower, Pedal; Internal/External: Lead, Sync, Exp.	
FOOT SWITCH	[Left] Mode: Off, Rhythm (Stop, Ending, Fill to A, Fill to B), Glide (Upper1, 2, Lead, Lower1, 2; Time); Tremolo [Right] Regist.Shift: Off, Shift, Jump, User	
KNEE LEVER	On/Off: Sustain (Upper, Lower); MOC; Lead Slide	
LCD DISPLAY	320 x 240 Dots	
OTHER CONTROLS	Power On/Off, Console Light On/Off, Expression Pedal, Master Volume, LCD Contrast, Display Select, Data Control, Menu, Page, Coarse, Hold, Manual Balance, Pedal Balance	
OTHER FITTINGS	XG Song Data Disk, 3.5" (blank) 2DD Floppy Disk, Owner's Manual, Matching Bench, Music Stand, MIDI In/Out, Phones, Aux In/Out (RCA; R/L); Mic, Mic Volume, Mic Reverb	
SOUND SYSTEM	Power Amplifiers	340W
	Speakers	30cm x 2; 18cm x 2; 2.5cm x 2; Monitor 5cm x 2 (11-13/16" x 2; 7-1/16" x 2; 1" x 2; Monitor 2" x 2)
DIMENSIONS	Width x Depth x Height	1235mm x 614mm x 1086mm (48-5/8" x 24-3/16" x 42-3/4")
WEIGHT	119Kg (262-3/8 lbs.)	

Specifications and description in this Owner's Manual are information purposes only. Yamaha Corp. reserves the right to change or modify products or specifications at any time without prior notice. As specifications, equipment or options may not be the same in every locale, please check with Yamaha dealer.

# ***Index***

## **A**

A.B.C. (Auto Bass Chord)	55
Accomp. Part	51
Accompaniment Control	47, 49, 50
Accompaniment Program Drum List	126
Accompaniment Program Voice List	125
Accompaniment Program	122
After (Touch Tone)	33, 34
All Play (XG/GM)	102
All Repeat (M.D.R.)	101
All Repeat (Demo)	8
Assign (Keyboard Percussion)	65
Attack (Voice Edit, EG Rate)	117
Attack/Chiff	29
Auto (MIDI)	164
AUX IN/OUT jacks	159

## **B**

B/C (Bass/Chord)	24
Balance (Delay)	38
BAR/BEAT indicator	46
Bass/Chord	51
Beat	130
Brilliance	34
bulk data	75, 87, 95, 96, 144, 152

## **C**

Celeste	37
Chord Cancel	57, 58
Chorus (Accompaniment Program)	139
Chorus	40
Clear (Keyboard Percussion)	66
Clear (Registration Shift)	78
Clear (Sequence Program)	149
Clear All Data (Accompaniment Program)	141
Click Volume	28
Click	28
COARSE button	14
Console Light	7
CONTRAST dial	14
Control (M.D.R.)	93
Copy (Keyboard Percussion)	68
Copy (Sequence Program)	150
Copy Protect	113
Custom A.B.C.	56
Custom Play	94, 108
Cutoff	116

## **D**

D. (Disable)	61, 74
Data Control buttons	11
Decay	117
DEL. (Delete; Registration Shift)	78
DEL. (Delete; Sequence Program)	149
Delay (Vibrato)	36
Delay	38
Delete (Accompaniment Program)	135
Delete (Input Name)	98
Demo Songs	8
Depth (Flanger)	38
Depth (Reverb)	41
Depth (Vibrato)	36
Direct Cancel	135
DISK button	88
Disk Copy	111
Disk Format	86
disks	74, 83
DISPLAY SELECT buttons	11
DOC (MIDI)	163
DOC	87, 104
dotted buttons (Style)	52
dotted buttons (Voice)	19

## **E**

Edit (Registration Shift)	78
Edit (Sequence Program)	146
Effect (Extra Voice)	31
Effect (Flute/Tibia)	28
Effect (Reverb)	42
Effect (Voice sections)	34
Effect Set	37
EG Rate	117
Electone (MIDI)	163
Ending	50, 148, 154
ENSEMBLE buttons	15, 18, 26, 29, 62
EXP. (Expression; MIDI)	164
Expression pedal	7
Extra Feet (Extra Voice)	31
Extra Voice Volume	31
Extra Voice	29

## **F**

F.B. (Feedback; Delay)	38
F.B. (Feedback; Flanger)	38
Fast Forward (F.F.)	108
Feet	34
Fill In	49, 50, 148, 154
Filter	116
Fingered Chord	56

Fingered Mode Chords	58
Flanger	38
Flute Volume	28
Flute/Tibia	26
Footswitch, left	44, 153
Footswitch, right	76
Format	85
FREE AREA	140

## **G**

Glide (Footswitch control)	44, 155
Glide	44
GM	87

## **H**

Headphones	159
Help messages	13
HOLD button	14

## **I**

Initial (Touch Tone)	33, 34
Initial Registration	81
Input Name (Accompaniment Program)	130, 140
Input Name (M.D.R.)	97
Input Name (Voice Edit)	115, 118
INS. (Insert; Registration Shift)	78
INS. (Insert; Sequence Program)	149
Insert (Input Name)	98
Internal/External (MIDI)	164
Intro	47, 50, 148

## **J**

Jump (Registration Shift)	77
---------------------------	----

## **K**

K.B.P. (M.D.R.)	93
K.B.P. (Reverb)	42
Key Set	72
Keyboard Percussion	61
Keyboard Percussion, User	64
Knee Lever	35, 156

## **L**

L.M. Split	71
LCD display	11
Lead (MIDI)	164
Lead Slide (Knee Lever control)	35, 158
Lead Voice	15, 18
Left (DOC)	104
Length (Attack/Chiff)	29
Length (Reverb)	41
Length (Sustain)	44
LK Preset	68

**M**

M./TO DISK button	73
M.D.R. (Music Disk Recorder)	83
Main A/B	49, 50, 148
Manual Balance	18, 24
Manual Volume	24
MASTER VOLUME control	7
Measure	130
Melody On Chord (Knee Lever control)	70, 157
Melody On Chord	70
Memory (A.B.C.)	59, 60
Menu buttons	11
METRO (Metronome)	130
MIC jack	159
MIC REV dial	159
MIC VOL dial	159
MIDI IN/OUT terminals	159
MIDI receive channels	164
MIDI	162
Minus One (XG/GM)	102
Mode (A.B.C.)	55, 56, 60
Mode (Melody On Chord)	70
Mode (MIDI)	163
Mode (Repeat)	115
Mode (Reverb)	41
Mute (Accompaniment Program)	134

**N**

Note Value	38
------------	----

**O**

Octave Up	72
OL (Output Level)	116
Orchestra (DOC)	104
Organ Variation	27
Output (MIDI)	163

**P**

PAGE buttons	11
Pan (Accompaniment Program)	139
Pan	25, 34
Part Copy (Accompaniment Program)	136, 137
Part Quantize	136, 138
Pause	108
Pedal Balance	18, 24
Pedal Volume	24
PHONES jack	159
Phrase Repeat (DOC)	105
Pitch	160, 161
PK Preset	69
Play Part (DOC)	105
Play Part (XG/GM)	103
Position controls (Registration Shift)	78
Position controls (Sequence Program)	149
Power On Reset	79

**R**

Random Repeat (Demo)	101
Random Repeat (M.D.R.)	101
Recall Panel	80
Receive Channels (MIDI)	164
Registration Memory	73
Registration Menu	9
Registration Shift	76
REL. (Release)	117
remaining memory (M.D.R.)	113
Repeat (Demo)	8
Repeat (Voice Edit)	115
Repeat Play (M.D.R.)	101
RES. (Resonance)	116
Response	28
Retry	90
Reverb (Accompaniment Program)	139
Reverb	41
Rewind (REW.)	108
Rhythm (footswitch control)	154
Rhythm	24, 51
Right (DOC)	104

**S**

SECT (Section; Accompaniment Program)	130
Sections	50, 124, 148
SEQ. buttons	151
Sequence Program	145
Set (Registration Shift)	78
Set (Sequence Program)	149
Single Finger Mode Chords	57
Single Finger	56
Single Repeat (Demo)	8
Single Repeat (M.D.R.)	101
Slide	35, 158
Solo Play (XG/GM)	102
Song Copy	110
Song Delete	111
SONG SELECT	75, 89
Space (Input Name)	98
Spec (Repeat)	116
Speed (Delay)	38
Speed (Flanger)	38
Speed (Vibrato)	36
Speed(Tremolo)	40
Split	71
Start	47
Style Condition	51
Style File disks	87, 107
Style Menu/Style List	54
Style volume	24, 46
Styles	45
Sustain (Knee Lever control)	43
Sustain	43

Symphonic	37
Sync (MIDI)	164
Synchro Start	47

**T**

Tempo (Accompaniment Program)	132
Tempo (M.D.R.)	109
Tempo (Styles)	46
TEMPO controls	46
TEMPO indicator	46
Time (Glide)	155
Time (Slide)	35
To Lower	18
Touch Tone	33
Touch Vibrato	35
Transpose	160, 161
Tremolo (Footswitch control)	40, 156
Tremolo	39
Tune	36
Type (Tremolo)	40

**U**

User (Registration Shift)	77
User 1/2 (Keyboard Percussion)	64, 69
User Keyboard Percussion Categories	67
User Style	54, 129, 140, 143, 144, 147
User Vibrato	35
User Voice	21, 119-121

**V**

Vibrato	35
Voice Condition page	33
Voice Display	6, 23
Voice Edit	114
Voice Group (Reverb)	42
Voice Menus/Voice List	21
Voice Pan	25
Voice sections	15
Volume (Accompaniment Program)	139
Volume (Bass/Chord)	24, 46, 51
Volume (Click)	28
Volume (Extra Voice)	31
Volume (Flute/Tibia)	28
Volume (Keyboard Percussion)	62
Volume (Pedal Voice sections)	18, 24
Volume (Rhythm)	24, 46, 51
Volume (Styles)	24, 46, 51
Volume (Voice sections)	16, 34

**W**

Write-protect	84
---------------	----

**X**

XG	9, 87
XG/GM (MIDI)	163
XG/GM	102

**YAMAHA**  
YAMAHA CORPORATION

M.D.G., EMI Division, © Yamaha Corporation 1996  
VU 94440 609MWCP3.2-01A0 Printed in Japan