

ELECTRONIC PIANO

PF-1000

Owner's Manual

Before using the PF-1000, be sure to read "Precautions," on pages 3-4.

IMPORTANT

Check your power supply

Make sure that your local AC mains voltage matches the voltage specified on the name plate on the bottom panel. In some areas a voltage selector may be provided on the bottom panel of the main keyboard unit. Make sure that the voltage selector is set for the voltage in your area. The voltage selector is set at 240V when the unit is initially shipped. To change the setting use a "minus" screwdriver to rotate the selector dial so that the correct voltage appears next to the pointer on the panel.

SPECIAL MESSAGE SECTION

PRODUCT SAFETY MARKINGS: Yamaha electronic products may have either labels similar to the graphics shown below or molded/stamped facsimiles of these graphics on the enclosure. The explanation of these graphics appears on this page. Please observe all cautions indicated on this page and those indicated in the safety instruction section.

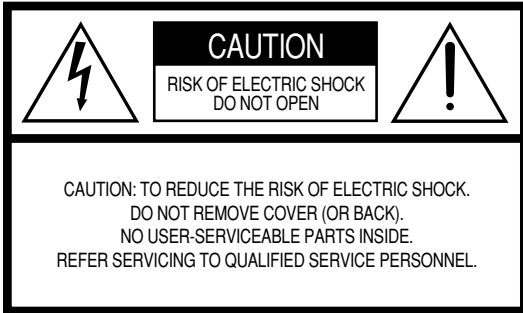

See bottom of Keyboard enclosure for graphic symbol markings.



The exclamation point within the equilateral triangle is intended to alert the user to the presence of important operating and maintenance (servicing) instructions in the literature accompanying the product.

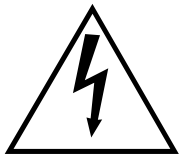

The lightning flash with arrowhead symbol, within the equilateral triangle, is intended to alert the user to the presence of uninsulated “dangerous voltage” within the product’s enclosure that may be of sufficient magnitude to constitute a risk of electrical shock.

IMPORTANT NOTICE: All Yamaha electronic products are tested and approved by an independent safety testing laboratory in order that you may be sure that when it is properly installed and used in its normal and customary manner, all foreseeable risks have been eliminated. DO NOT modify this unit or commission others to do so unless specifically authorized by Yamaha. Product performance and/or safety standards may be diminished. Claims filed under the expressed warranty may be denied if the unit is/has been modified. Implied warranties may also be affected.

SPECIFICATIONS SUBJECT TO CHANGE: The information contained in this manual is believed to be correct at the time of printing. However, Yamaha reserves the right to change or modify any of the specifications without notice or obligation to update existing units.

ENVIRONMENTAL ISSUES: Yamaha strives to produce products that are both user safe and environmentally friendly. We sincerely believe that our products and the production methods used to produce them, meet these goals. In keeping with both the letter and the spirit of the law, we want you to be aware of the following:

Battery Notice: This product MAY contain a small non-rechargeable battery which (if applicable) is soldered in place. The average life span of this type of battery is approximately five years. When replacement becomes necessary, contact a qualified service representative to perform the replacement.

Warning: Do not attempt to recharge, disassemble, or incinerate this type of battery. Keep all batteries away from children. Dispose of used batteries promptly and as regulated by applicable laws. Note: In some areas, the servicer is required by law to return the defective parts. However, you do have the option of having the servicer dispose of these parts for you.

Disposal Notice: Should this product become damaged beyond repair, or for some reason its useful life is considered to be at an end, please observe all local, state, and federal regulations that relate to the disposal of products that contain lead, batteries, plastics, etc.

NOTICE: Service charges incurred due to lack of knowledge relating to how a function or effect works (when the unit is operating as designed) are not covered by the manufacturer’s warranty, and are therefore the owners responsibility. Please study this manual carefully and consult your dealer before requesting service.

NAME PLATE LOCATION: The graphic below indicates the location of the name plate. The model number, serial number, power requirements, etc., are located on this plate. You should record the model number, serial number, and the date of purchase in the spaces provided below and retain this manual as a permanent record of your purchase.



PF-1000

Model _____

Serial No. _____

Purchase Date _____

PRECAUTIONS

PLEASE READ CAREFULLY BEFORE PROCEEDING

* Please keep this manual in a safe place for future reference.



WARNING

Always follow the basic precautions listed below to avoid the possibility of serious injury or even death from electrical shock, short-circuiting, damages, fire or other hazards. These precautions include, but are not limited to, the following:

Power supply/Power cord

- Only use the voltage specified as correct for the instrument. The required voltage is printed on the name plate of the instrument.
- Check the electric plug periodically and remove any dirt or dust which may have accumulated on it.
- Use only the supplied power cord/plug.
- Do not place the power cord near heat sources such as heaters or radiators, and do not excessively bend or otherwise damage the cord, place heavy objects on it, or place it in a position where anyone could walk on, trip over, or roll anything over it.

Do not open

- Do not open the instrument or attempt to disassemble the internal parts or modify them in any way. The instrument contains no user-serviceable parts. If it should appear to be malfunctioning, discontinue use immediately and have it inspected by qualified Yamaha service personnel.

Water warning

- Do not expose the instrument to rain, use it near water or in damp or wet conditions, or place containers on it containing liquids which might spill into any openings.
- Never insert or remove an electric plug with wet hands.

Fire warning

- Do not put burning items, such as candles, on the unit. A burning item may fall over and cause a fire.

If you notice any abnormality

- If the power cord or plug becomes frayed or damaged, or if there is a sudden loss of sound during use of the instrument, or if any unusual smells or smoke should appear to be caused by it, immediately turn off the power switch, disconnect the electric plug from the outlet, and have the instrument inspected by qualified Yamaha service personnel.



CAUTION

Always follow the basic precautions listed below to avoid the possibility of physical injury to you or others, or damage to the instrument or other property. These precautions include, but are not limited to, the following:

Power supply/Power cord

- When removing the electric plug from the instrument or an outlet, always hold the plug itself and not the cord. Pulling by the cord can damage it.
- Remove the electric plug from the outlet when the instrument is not to be used for extended periods of time, or during electrical storms.
- Do not connect the instrument to an electrical outlet using a multiple-connector.
Doing so can result in lower sound quality, or possibly cause overheating in the outlet.

Assembling the keyboard stand

- Read carefully this manual or the attached documentation explaining the assembly process.
Failure to assemble the stand in the proper sequence might result in damage to the instrument or even injury.

Location

- Do not expose the instrument to excessive dust or vibrations, or extreme cold or heat (such as in direct sunlight, near a heater, or in a car during the day) to prevent the possibility of panel disfiguration or damage to the internal components.
- Do not use the instrument in the vicinity of a TV, radio, stereo equipment, mobile phone, or other electric devices. Otherwise, the instrument, TV, or radio may generate noise.
- Do not place the instrument in an unstable position where it might accidentally fall over.
- Before moving the instrument, remove all connected cables.
- Do not place objects in front of the instrument's air vent, since this may prevent adequate ventilation of the internal components, and possibly result in the instrument overheating.

Connections

- Before connecting the instrument to other electronic components, turn off the power for all components. Before turning the power on or off for all components, set all volume levels to minimum. Also, be sure to set the volumes of all components at their minimum levels and gradually raise the volume controls while playing the instrument to set the desired listening level.

Maintenance

- When cleaning the instrument, use a soft, dry or slightly damp cloth. Do not use paint thinners, solvents, cleaning fluids, or chemical-impregnated wiping cloths.

Handling caution

- Never insert or drop paper, metallic, or other objects into the gaps on the panel or keyboard. If this happens, turn off the power immediately and unplug the power cord from the AC outlet. Then have the instrument inspected by qualified Yamaha service personnel.
- Do not place vinyl, plastic or rubber objects on the instrument, since this might discolor the panel or keyboard.
- Do not rest your weight on, or place heavy objects on the instrument, and do not use excessive force on the buttons, switches or connectors.
- Do not operate the instrument for a long period of time at a high or uncomfortable volume level, since this can cause permanent hearing loss. If you experience any hearing loss or ringing in the ears, consult a physician.

Using the bench (If included)

- Do not place the bench in an unstable position where it might accidentally fall over.
- Do not play carelessly with or stand on the bench. Using it as a tool or step-ladder or for any other purpose might result in accident or injury.
- Only one person should sit on the bench at a time, in order to prevent the possibility of accident or injury.
- If the bench screws become loose due to extensive long-term use, tighten them periodically using the included tool.

Saving data

Saving and backing up your data

- Current memory data (see page 39) is lost when you turn off the power to the instrument. Save the data to a floppy disk/the User Drive (see page 39).

Saved data may be lost due to malfunction or incorrect operation. Save important data to a floppy disk.

When you change settings in a display page and then exit from that page, System Setup data (listed in the Parameter Chart of the separate Data List booklet) is automatically stored. However, this edited data is lost if you turn off the power without properly exiting from the relevant display.

Backing up the floppy disk

- To protect against data loss through media damage, we recommend that you save your important data onto two floppy disks.

Yamaha cannot be held responsible for damage caused by improper use or modifications to the instrument, or data that is lost or destroyed.

Always turn the power off when the instrument is not in use.

Thank you for purchasing the Yamaha PF-1000 electronic piano! We recommend that you read this manual carefully so that you can fully take advantage of the advanced and convenient functions of the PF-1000. We also recommend that you keep this manual in a safe and handy place for future reference.

About this Owner's Manual and Data List

This manual consists of four main sections: Introduction, Quick Guide, Basic Operation, and Reference. Also, a separate Data List is provided.

Introduction (page 2): Please read this section first.

Quick Guide (page 20): This section explains how to use the basic functions.

Basic Operation (page 38): This section explains how to use the basic operations including display-based controls.

Reference (page 52): This section explains how to make detailed settings for the PF-1000's various functions.

Data List : Voice List, MIDI Data Format, etc.

- * The illustrations and LCD screens as shown in this owner's manual are for instructional purposes only, and may appear somewhat different from those on your instrument.
- * The example Operation Guide displays shown in this Manual are in English.
- * The bitmap fonts used in this instrument have been provided by and are the property of Ricoh co., Ltd.
- * Copying of the commercially available software is strictly prohibited except for your personal use.

COPYRIGHT NOTICE

This product incorporates and bundles computer programs and contents in which Yamaha owns copyrights or with respect to which it has license to use others' copyrights. Such copyrighted materials include, without limitation, all computer software, styles files, MIDI files, WAVE data and sound recordings. Any unauthorized use of such programs and contents outside of personal use is not permitted under relevant laws. Any violation of copyright has legal consequences. DON'T MAKE, DISTRIBUTE OR USE ILLEGAL COPIES.

Trademarks:

- Apple and Macintosh are trademarks of Apple Computer, Inc.
- IBM-PC/AT is a trademark of International Business Machines Corporation.
- Windows is the registered trademark of Microsoft® Corporation.
- All other trademarks are the property of their respective holders.

Accessories

- "50 greats for the Piano" Disk (and Music Book)
- Recording disk
- Owner's Manual
- Data List
- Pedal Unit
- Bench (included or optional depending on locale)
- Dust Cover
- Music Rest
- Keyboard Stand

Handling the Floppy Disk Drive (FDD) and Floppy Disk

Precautions

Be sure to handle floppy disks and treat the disk drive with care. Follow the important precautions below.

Compatible Disk Type

- 3.5" 2DD and 2HD type floppy disks can be used.

Inserting/Ejecting Floppy Disks

To insert a floppy disk into the disk drive:

- Hold the disk so that the label of the disk is facing upward and the sliding shutter is facing forward, towards the disk slot. Carefully insert the disk into the slot, slowly pushing it all the way in until it clicks into place and the eject button pops out.

Drive lamp

When the power is turned on, the drive lamp (at the bottom left of the drive) lights to indicate the drive can be used.

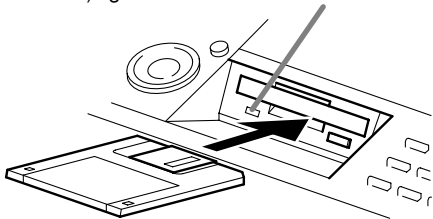

To eject a floppy disk:

Before ejecting the disk, be sure to confirm that data is not being written to the floppy disk.

If data is currently being written to the floppy disk in the following operations, the messages "Now executing," "Now copying," and "Now formatting" appears in the display.

- Moving, copying, pasting, saving, or deleting data (page 42 - 44).
- Naming files and folders (page 41); creating a new folder (page 44).
- Copying a disk to another disk (page 139); formatting the disk (page 139).

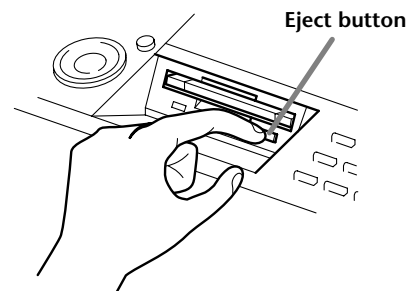

- Never attempt to remove the disk or turn the power off when the data is being written to the floppy disk. Doing so can damage the disk and possibly the disk drive. Press the eject button slowly as far as it will go; the disk will automatically pop out. When the disk is fully ejected, carefully remove it by hand.
- If the eject button is pressed too quickly, or if it is not pressed in as far as it will go, the disk may not eject properly. The eject button may become stuck in a half-pressed position with the disk extending from the drive slot by only a few millimeters. If this happens, do not attempt to pull out the partially ejected disk, since using force in this situation can damage the disk drive mechanism or the floppy disk. To remove a partially ejected disk, try pressing the eject button once again, or push the disk back into the slot and then repeat the eject procedure.
- Be sure to remove the floppy disk from the disk drive before turning off the power. A floppy disk left in the drive for extended periods can easily pick up dust and dirt that can cause data read and write errors.

Cleaning the Disk Drive Read/Write Head

- Clean the read/write head regularly. This instrument employs a precision magnetic read/write head which, after an extended period of use, will pick up a layer of magnetic particles from the disks used that will eventually cause read and write errors.
- To maintain the disk drive in optimum working order Yamaha recommends that you use a commercially-available dry-type head cleaning disk to clean the head about once a month. Ask your Yamaha dealer about the availability of proper head-cleaning disks.
- Never insert anything but floppy disks into the disk drive. Other objects may cause damage to the disk drive or floppy disks.

About the Floppy Disks

To handle floppy disks with care:

- Do not place heavy objects on a disk or bend or apply pressure to the disk in any way. Always keep floppy disks in their protective cases when they are not in use.
- Do not expose the disk to direct sunlight, extremely high or low temperatures, or excessive humidity, dust or liquids.
- Do not open the sliding shutter and touch the exposed surface of the floppy disk inside.
- Do not expose the disk to magnetic fields, such as those produced by televisions, speakers, motors, etc., since magnetic fields can partially or completely erase data on the disk, rendering it unreadable.

- Never use a floppy disk with a deformed shutter or housing.
- Do not attach anything other than the provided labels to a floppy disk. Also make sure that labels are attached in the proper location.

To protect your data (Write-protect Tab):

- To prevent accidental erasure of important data, slide the disk's write-protect tab to the "protect" position (tab open).

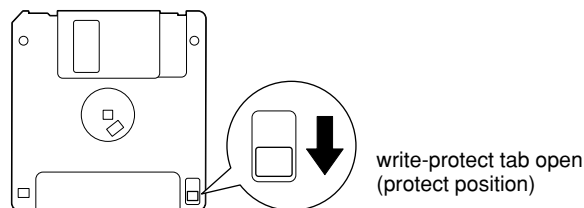

Data backup

- For maximum data security Yamaha recommends that you keep two copies of important data on separate floppy disks. This gives you a backup if one disk is lost or damaged. To make a backup disk use the Disk to Disk function on page 139.

About the Display Messages

A message (information or confirmation dialog) sometimes appears on the screen to facilitate operation.

When such messages appear, simply follow the instructions as shown by pressing the corresponding button.

NOTE

You can select the desired language from the Help display (page 49).

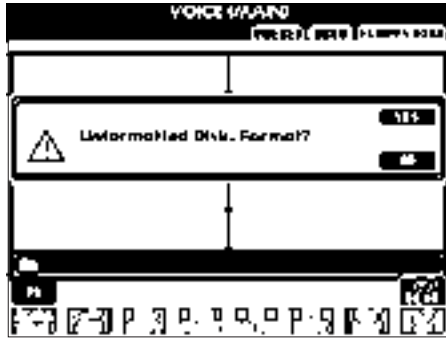

For this example, press the **[G] (YES)** button to execute formatting.

Table of Contents

Introduction

SPECIAL MESSAGE SECTION	2
PRECAUTIONS	3
About this Owner's Manual and Data List	5
Accessories	6
Handling the Floppy Disk Drive (FDD) and Floppy Disk.....	6
About the Display Messages.....	8
Application Index.....	12
What can you do with the PF-1000?.....	14
Setting Up the PF-1000.....	16
About the pedal unit.....	16
About the music rest.....	16
Turning the Power On and Off.....	16
Using headphones	17
Panel Controls and Terminals.....	18

Quick Guide

Playing the Demos	20
Song Playback	21
Playback of Songs	21
Playing Voices	25
Playing a Voice	25
Playing Two Voices Simultaneously	26
Playing Different Voices with the Left and Right Hands	27
Playing Styles	28
Playing a style.....	28
Style Sections.....	30
One Touch Setting.....	32
Music Finder	33
Using the Music Finder	33
Searching the Music Finder Records.....	34
Saving and Recalling Music Finder Data	35
Playing and Practicing with the Songs.....	36
Playing Along with the PF-1000	36
Recording	37

Basic Operations

— Organizing Your Data 38

Selecting Files and Folders.....	40
File/Folder-related Operations	41
Naming Files/Folders	41
Moving Files/Folders	42
Copying Files/Folders.....	43
Deleting Files/Folders.....	43
Saving Files	44
Organizing Files by Creating a New Folder	44
Displaying Upper Level pages	44
Entering Characters and Changing Icons	44
Using the [DATA ENTRY] Dial.....	46
Direct Access — Instant Selection of Displays.....	47

Help Messages.....	49
Using the Metronome.....	50
Adjusting the Tempo	50
Tap Tempo	51

Reference

Playing the Demos.....52

Voices.....54

Selecting a Voice	54
One-touch Piano Play.....	55
Layer/Left — Playing Several Sounds	
Simultaneously	56
Layer — Layering Two Different Voices	56
Left — Setting Separate Voices for the Left and Right Sections of the Keyboard	57
Applying Voice Effects	57
Using the Pedals.....	58

Styles.....59

Playing a style	59
Playing a Style's Rhythm Channels only	61
Adjusting the Volume Balance/Channel Muting	61
Chord Fingerings.....	62
Arranging the Style Pattern (SECTIONS: MAIN A/B/C/D, INTRO, ENDING, BREAK)	64
Stopping the Style Playback While Releasing Keys (SYNC. STOP)	65
Selecting Intro and Ending Types (INTRO/ENDING)	66
Playing Fill-in patterns automatically when changing accompaniment sections — Auto Fill In.....	66
Appropriate Panel Setting for the Selected Style (ONE TOUCH SETTING).....	67
Automatically Changing One Touch Settings with the Sections — OTS Link	68
Registering the Panel Controls in One Touch Setting (ONE TOUCH SETTING).....	68
Calling Up Ideal Setups for Your Music	
— Music Finder.....	69
Searching the Ideal Setups — Music Finder Search....	70
Editing Records — Music Finder Record Edit	71

Song Playback 73

Compatible Song Types.....	73
Song Playback	74
Playing the Internal Songs.....	74
Playing Back Songs on Disk.....	76
Other Playback-related Operations.....	76
Muting Specific Parts	
— Track1/Track2/Extra Tracks.....	77
Repeat Playback of a Specific Range	77
Displaying Music Notation — Score	78
Displaying the Lyrics	81

Saving and Recalling Custom Panel Setups

— Registration Memory 82

Registering Panel Setups	
— Registration Memory.....	82
Saving Your Registration Memory Setups.....	83
Recalling a Registration Memory Setup	84

Editing Voices

— Sound Creator 85

Operation	85
SOUND CREATOR Parameters	86

Recording Your Performances and Creating Songs

— Song Creator 90

About Song Recording.....	90
Quick Recording.....	91
Multi Recording	92
Recording Individual Notes — Step Record	94
Operation	94
Recording Melodies — Step Record (Note).....	96
Recording Chord Changes for the Auto Accompaniment — Step Record (Chord)	97
Select the Recording Options: Starting, Stopping, Punching In/Out — Rec Mode.....	99
Editing a Recorded Song	100
Editing Channel-related Parameters — Channel	100
Editing Note Events — 1 - 16.....	103
Editing Chord Events — CHD.....	104
Editing System Events	
— SYS/EX. (System Exclusive).....	104
Inputting and Editing Lyrics	105
Customizing the Event List — Filter.....	105

Creating Accompaniment Styles — Style Creator 106

About Creating Accompaniment Styles.....	106
Style File Format.....	107
Operation	107
Realtime Recording — Basic	108
Step Recording.....	109
Assembling an Accompaniment Style —Assembly..	110
Edit the Created Accompaniment Style	111
Change the Rhythmic Feel	
— Groove and Dynamics	111
Editing the Channel Data.....	113
Making Style File Format Settings —Parameter	114

Adjust the Volume Balance and Changing Voices

— Mixing Console 116

Operation	116
Setting the Level Balance and Voice	
— Volume/Voice	117
Changing the Tone of the Voice — Filter.....	118
Changing Pitch-related Settings — Tune.....	118
Adjusting the Effects.....	119
Effect Structure	121

Making Global and Other Important Settings

— Function..... 122

Operation	122
Fine Tuning the Pitch/Selecting a Scale	
— Master Tune/Scale Tune.....	124
Tuning the Overall Pitch — Master Tune.....	124
Selecting a Scale — Scale Tune	124
Setting Song-related Parameters	
— Song Settings.....	126
Setting Auto Accompaniment-related Parameters — Style Setting, Split Point, and Chord Fingering.....	127
Setting Auto Accompaniment-related Parameters	
— Style Setting and Split Point	127
Setting the Fingering Method — Chord Fingering..	128
Making Settings for the Pedals and Keyboard	
— Controller.....	128
Making Settings for the Pedals	128
Changing the Touch Sensitivity and Transpose	
— Keyboard/Panel.....	130
Setting the Registration Sequence, Freeze, and Voice Set.....	131
Specifying the Order for Calling Up Registration	
Memory Presets — Registration Sequence.....	131
Maintaining Panel Settings — Freeze	131
Changing the Automatically Selected Voice	
Settings — Voice Set.....	132

Setting Harmony and Echo	132
Showing the PF-1000 Display on a TV	
— Video Out	133
Setting the MIDI Parameters	134
Making Overall System Settings	
(Local Control, Clock, etc.) — System	134
Transmitting MIDI Data — Transmit	135
Receiving MIDI Data — Receive	136
Setting Root Note Channels — Root	136
Setting Chord Channels — Chord Detect	136
Other Settings — Utility	137
Making Settings for Fade In/Out, Metronome,	
Parameter Lock, and Tap — CONFIG 1	137
Making Settings for the Display, Speaker System,	
and Voice Number Indication — CONFIG 2	138
Copying and Formatting Disks — Disk	139
Entering Your Name and Language Preference	
— Owner	140
Restoring the Factory-programmed Settings	
of the PF-1000 — System Reset	140

Using Your PF-1000 with Other Devices..... 141

Using the Headphones (PHONES jacks).....	141
Connecting the Microphone or Guitar	
(MIC/LINE IN jack).....	141
Connecting Audio & Video Devices	142
Using the Pedal (footswitch) or Foot Controller	
(AUX PEDAL jack)	143
Connecting external MIDI devices	
(MIDI terminals)	143
Connecting to a Computer	
(MIDI terminals/TO HOST terminal).....	143
What's MIDI?	145
What You Can Do With MIDI	147
Data Compatibility	148
Disk format.....	148
Sequence Format.....	148
Voice Allocation Format	149

Assembling the Keyboard Stand 150

Troubleshooting..... 152

Specifications 154

Index 156

Introduction

Quick Guide

Basic Operations - Organizing Your Data

Playing the Demos

Voices

Styles

Song Playback

Saving and Recalling Custom
Panel Setups - Registration Memory

Editing Voices - Sound Creator

Recording Your Performances
and Creating Songs - Song Creator

Creating Accompaniment Styles
- Style Creator

Adjust the Volume Balance
and Changing Voices - Mixing Console

Making Global and Other Important
Settings - Function

Using Your PF-1000 with Other Devices

Appendix

Application Index

Use this index to find reference pages that may be helpful for your particular application and situation.

Listening

- Listening to the internal songs page 74
- Listening to disk songs “Playing Back Songs on Disk” on page 76
- Listening to demo songs page 52
- Listening to the demo of the selected voices page 54
- Listening to songs with the special voices of the PF-1000 page 117

Playing

- Calling up the piano setting page 55
- Using the three performance control pedals page 58
- Playing an accompaniment that matches pitch “Transpose Assign” on page 130
- Combining two voices “Layer — Layering Two Different Voices” on page 56
- Playing separate voices with the right and left hands
..... “Left — Setting Separate Voices for the Left and Right Sections of the Keyboard” on page 57

Changing the sound

- Enhancing the sound with reverb and other effects “Applying Voice Effects” on page 57
..... “Adjusting the Effects” on page 119
- Adjusting the Level Balance page 117
- Combining two voices “Layer — Layering Two Different Voices” on page 56
- Playing separate voices with the right and left hands
..... “Left — Setting Separate Voices for the Left and Right Sections of the Keyboard” on page 57
- Creating voices page 85

Playing the auto accompaniment

- Playing the accompaniment automatically page 59
- Calling up ideal panel settings for your music page 69

Practicing

- Muting the right- or left-hand part “Muting Specific Parts — Track1/Track2/Extra Tracks” on page 77
- Practicing with an accurate and steady tempo “Using the Metronome” on page 50

Recording

- Recording your performance pages 91, 92
- Creating a song by entering notes page 94

Creating your original settings

- Creating voices page 85
- Creating accompaniment styles page 106

Using a microphone

Connecting the microphone..... "Connecting the Microphone or Guitar (MIC/LINE IN jack)" on page 141

Settings

Registering Panel Setups..... page 82
Tuning the pitch/Selecting a scale page 124
Making detailed settings for playing back songs page 122
Making detailed settings for the auto accompaniment..... page 127
Making settings for the pedals..... "Making Settings for the Pedals and Keyboard — Controller" on page 128
Making detailed settings for the keyboard voices page 130
Showing the display on a TV "Showing the PF-1000 Display on a TV — Video Out" on page 133
Making detailed settings for MIDI page 134

Connecting the PF-1000 to other devices

Basic information on MIDI..... "What's MIDI?" on page 145
Recording your performance..... "Playing the sounds of the PF-1000 through an external audio system, and recording the sounds to an external recorder (AUX OUT jacks)" on page 142
Raising the volume "Playing the sounds of the PF-1000 through an external audio system, and recording the sounds to an external recorder (AUX OUT jacks)" on page 142
Outputting another instrument's sound from the PF-1000 "Outputting the sound of an external device through the built in speakers of the PF-1000 (AUX IN jacks)" on page 142
Connecting a computer..... "Connecting to a Computer (MIDI terminals/TO HOST terminals)" on page 143

Assembling the keyboard stand

Using the stand..... "Assembling the Keyboard Stand" on page 150

Quick solution

Basic functions of the PF-1000 and how you can best use itpages 12, 14
Resetting the PF-1000 to the default setting
..... "Restoring the Factory-programmed Settings of the PF-1000 — System Reset" on page 140
Displaying the Messages "About the Display Messages" on page 8
Troubleshooting..... page 152

What can you do with the PF-1000?

SONG

Playback previously recorded songs (page 21, 36, 73)

Enjoy a wide variety of preset songs as well as songs on commercially available disks.

DEMO

Explore the Demos (page 20, 52)

These not only showcase the stunning voices and styles of the instrument, they introduce you to the various functions and features — and give you hands-on experience using the PF-1000!

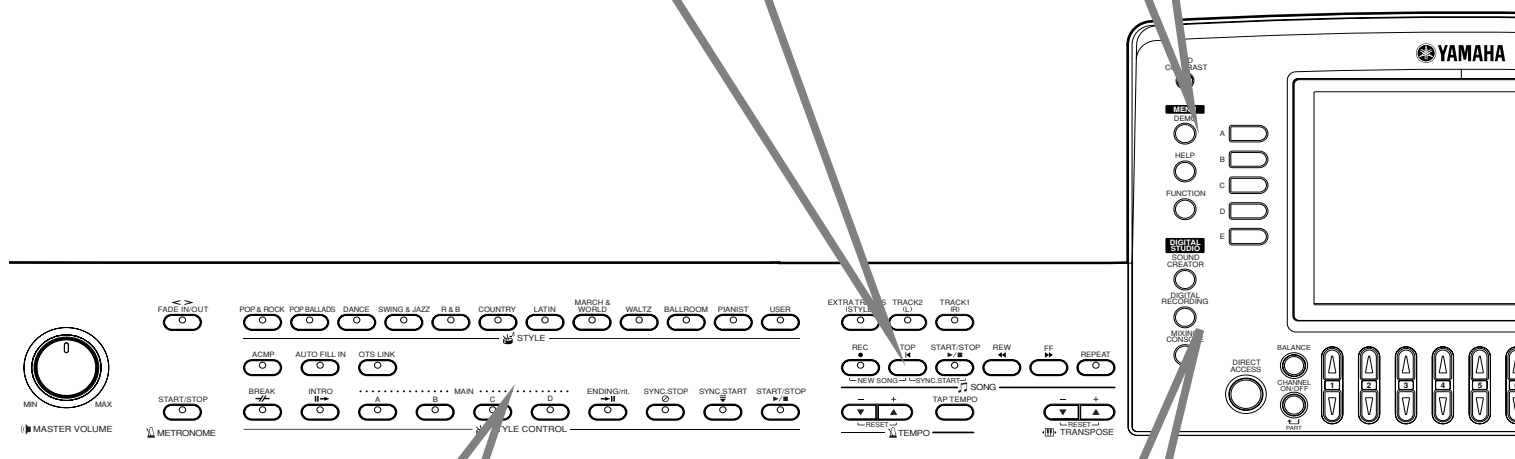

STYLE

Back up your performance with Auto Accompaniment (page 28, 59)

Playing a chord with your left hand automatically plays the auto accompaniment backing. Select an accompaniment style — such as pop, jazz, Latin, etc. — and let the PF-1000 be your backing band!

DIGITAL RECORDING

Record your performances (page 90, 106)

With the powerful and easy-to-use song recording features, you can record your own keyboard performances, and create your own complete, fully orchestrated compositions — which you can then save to the USER drive or a floppy disk for future recall.

LCD

The large LCD (together with the various panel buttons) provides comprehensive and easy-to-understand control of the PF-1000's operations.

MUSIC FINDER

Call up the perfect accompaniment style (page 33, 69)

If you know what song you want to play, but you don't know which style or voice would be right for it, let the Music Finder help you. Just select the song title, and the PF-1000 automatically calls up the most appropriate style and voice.

PIANO

Set up the piano — instantly (page 55)

You can call up all the optimum piano settings for the PF-1000 with just a single button press — then play the extraordinarily realistic grand piano voice.

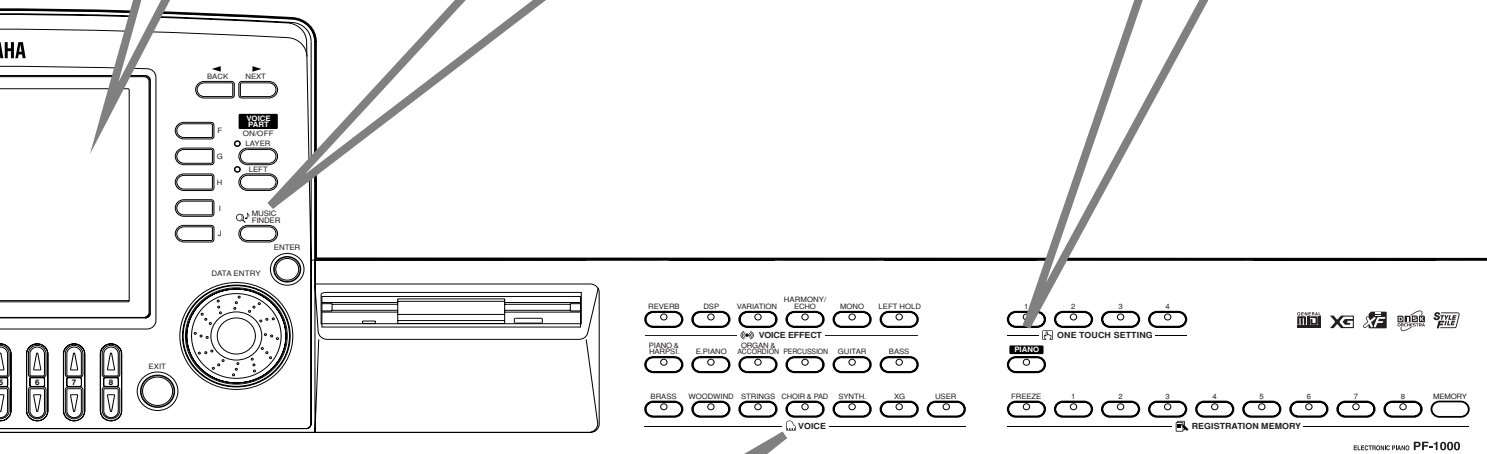

VOICE

Enjoy a huge variety of realistic voices (page 25, 54)

The PF-1000 features a wealth of exceptionally authentic and dynamic voices (more than 800) — including piano, strings, woodwinds, and more!

TO HOST terminal

Make music with a computer — quickly and easily (page 143)

Dive in and take advantage of the wide world of computer music software. Connections and setup are exceptionally easy, and you can play back your computer recorded parts with different instrument sounds — all from a single PF-1000!

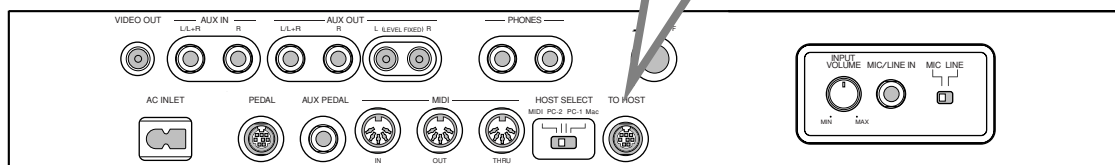

Setting Up the PF-1000

You do not need to install the stand to play the PF-1000. However, if you wish to assemble the stand, refer to page 150.

About the pedal unit

Insert the plug of the pedal unit, with the arrow in the plug facing upward.

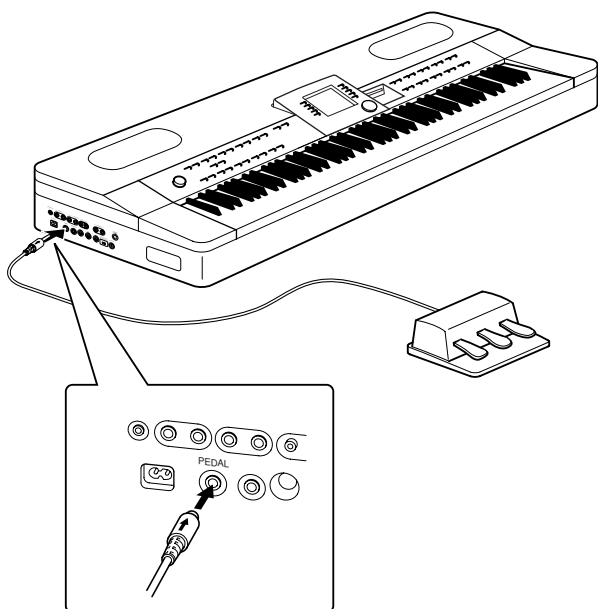

About the music rest

The PF-1000 is supplied with a music rest that can be attached to the instrument by inserting it into the holes at the rear of the control panel.

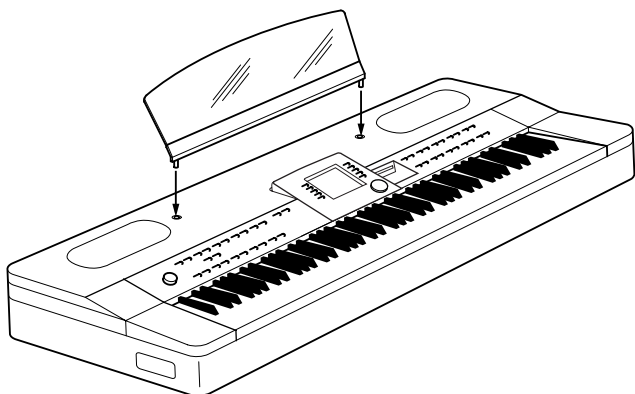

Turning the Power On and Off

Connect the power cable.

1 First insert the plug of the power cable into the [AC INLET] on the left side panel, then plug the other end of the cable into the proper AC outlet on the wall.

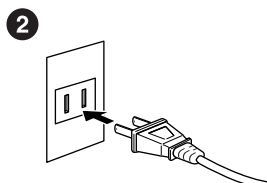
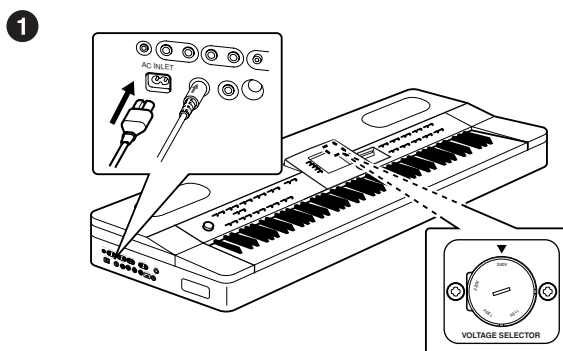

(The shape of plug differs depending on locale.)

⚠ WARNING

Make sure your PF-1000 is rated for the AC voltage supplied in the area in which it is to be used (voltage rating appears on the name plate on the bottom panel). In some areas, a voltage selector may be provided on the bottom panel of the main keyboard unit. Make sure that the voltage selector is set for the voltage in your area. Connecting the unit to the wrong AC supply can cause serious damage to the internal circuitry and may even pose a shock hazard! Use only the AC power cord supplied with the PF-1000. If the supplied cord is lost or damaged and needs to be replaced, contact your Yamaha dealer. The use of an inappropriate replacement can pose a fire and shock hazard!

The type of AC power cord provided with the PF-1000 may be different depending on the country in which it is purchased. (In some areas a plug adaptor may be provided to match the pin configuration of the AC wall outlets in your area.) DO NOT modify the plug provided with the PF-1000. If the plug will not fit the outlet, have a proper outlet installed by a qualified electrician.

- 2** Press the **[POWER]** switch located on the left side panel to turn on the power.
→ The main display appears in the LCD display.

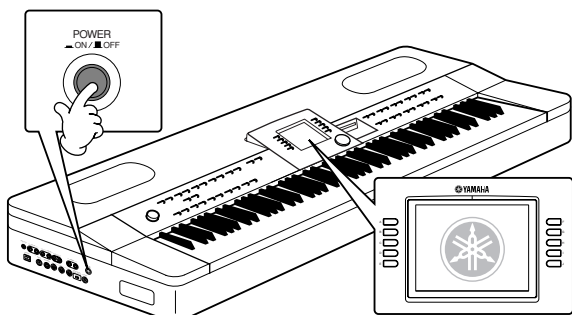

When you're ready to turn off the power, press the **[POWER]** switch again.
→ The display will turn off.

Adjusting the display contrast

If the LCD is difficult to read, adjust the contrast with the **[LCD CONTRAST]** knob at the left of the LCD.



Setting the volume

Use the **[MASTER VOLUME]** dial to adjust the volume to an appropriate level.

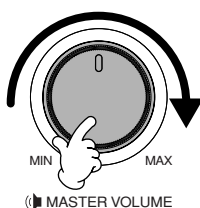

CAUTION

Do not use the PF-1000 at a high volume level for a long period of time, or your hearing may be damaged.

Using headphones

Connect a pair of headphones to one of the **[PHONES]** jacks on the left side panel.

Two **[PHONES]** jacks are provided.

Two sets of standard stereo headphones can be plugged in. (If you are using only one pair of headphones, you can plug them into either of these jacks.)

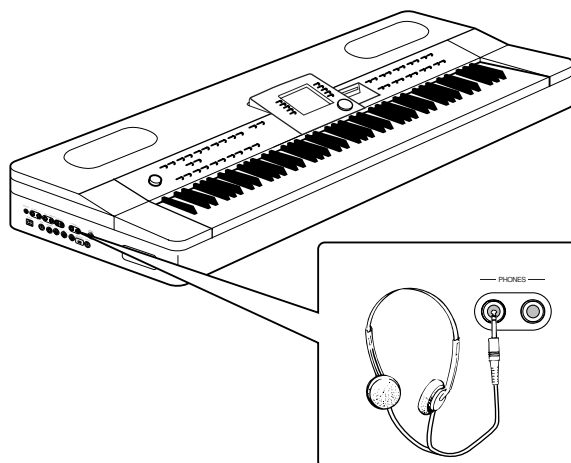

CAUTION

Do not use headphones at a high volume for an extended period of time. Doing so may cause hearing loss.

Panel Controls and Terminals

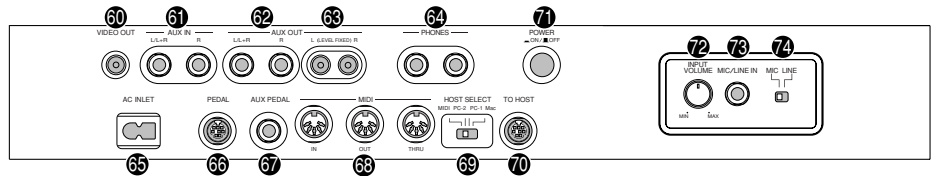
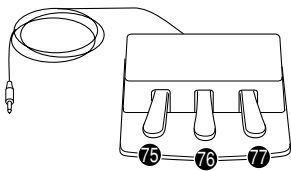
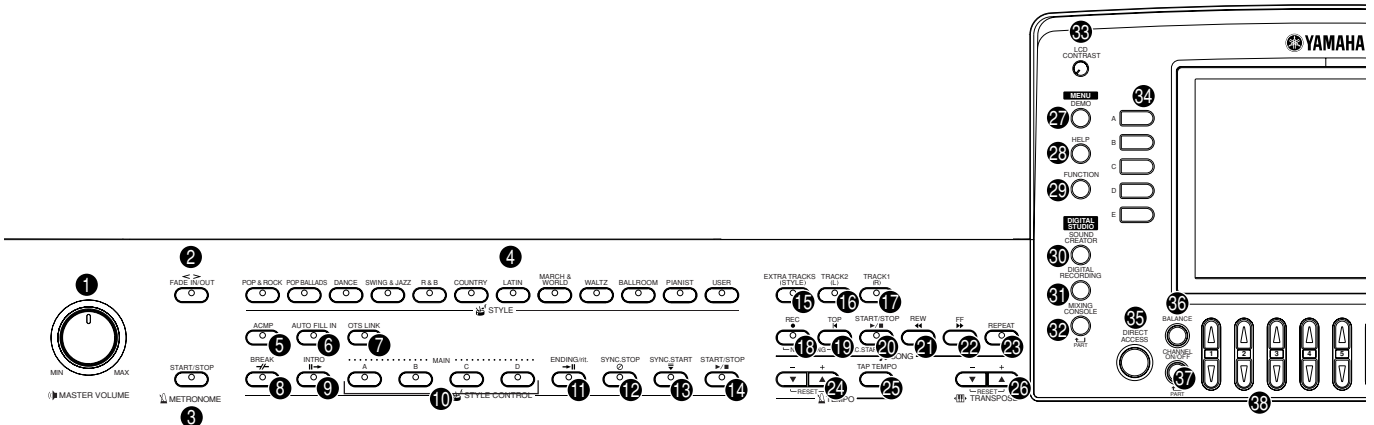

MASTER VOLUME

- 1 [MASTER VOLUME] dial P. 17
- 2 [FADE IN / OUT] button P. 65

METRONOME

- 3 [START / STOP] button (METRONOME)..... P. 50

STYLE

- 4 STYLE buttons P. 59

STYLE CONTROL

- 5 [ACMP] button P. 60
- 6 [AUTO FILL IN] button P. 66
- 7 [OTS LINK] button P. 68
- 8 [BREAK] button P. 64
- 9 [INTRO] button P. 31, 66
- 10 MAIN [A] - [D] buttons..... P. 64
- 11 [ENDING / rit.] button..... P. 31, 66
- 12 [SYNC.STOP] button P. 65
- 13 [SYNC.START] button P. 60
- 14 [START / STOP] button (STYLE CONTROL) P. 60

SONG

- 15 [EXTRA TRACKS (STYLE)] button P. 77
- 16 [TRACK 2 (L)] button P. 77
- 17 [TRACK 1 (R)] button P. 77
- 18 [REC] button P. 90
- 19 [TOP] button P. 76
- 20 [START / STOP] button (SONG)..... P. 74
- 21 [REW] button P. 76
- 22 [FF] button P. 76
- 23 [REPEAT] button..... P. 77

TEMPO

- 24 [-] [+] buttons (TEMPO) P. 50
- 25 [TAP TEMPO] button P. 51

TRANSPOSE

- 26 [-] [+] buttons (TRANSPOSE) P. 130

MENU

- 27 [DEMO] button P. 52
- 28 [HELP] button P. 49
- 29 [FUNCTION] button P. 122

DIGITAL STUDIO

- 30 [SOUND CREATOR] button..... P. 85
- 31 [DIGITAL RECORDING] button P. 90, 106
- 32 [MIXING CONSOLE] button P. 116

DISPLAY CONTROL

- 33 [LCD CONTRAST] knob..... P. 17
- 34 [A] - [J] buttons P. 40
- 35 [DIRECT ACCESS] button P. 47
- 36 [BALANCE] button..... P. 61
- 37 [CHANNEL ON / OFF] button..... P. 61, 76
- 38 [1▲▼] - [8▲▼] buttons P. 38 - 45
- 39 [BACK] button..... P. 40, 46
- 40 [NEXT] button P. 40, 46
- 41 [ENTER] button P. 46
- 42 [DATA ENTRY] dial P. 46
- 43 [EXIT] button..... P. 40

VOICE PART ON/OFF

- 44 [LAYER] button P. 56
- 45 [LEFT] button..... P. 56

MUSIC FINDER

- 46 [MUSIC FINDER] button..... P. 69
- 47 Floppy disk drive (3.5") P. 6

VOICE EFFECT

- 48 [REVERB] button..... P. 57
- 49 [DSP] button P. 57
- 50 [VARIATION] button P. 57
- 51 [HARMONY / ECHO] button..... P. 58
- 52 [MONO] button P. 58
- 53 [LEFT HOLD] button..... P. 58

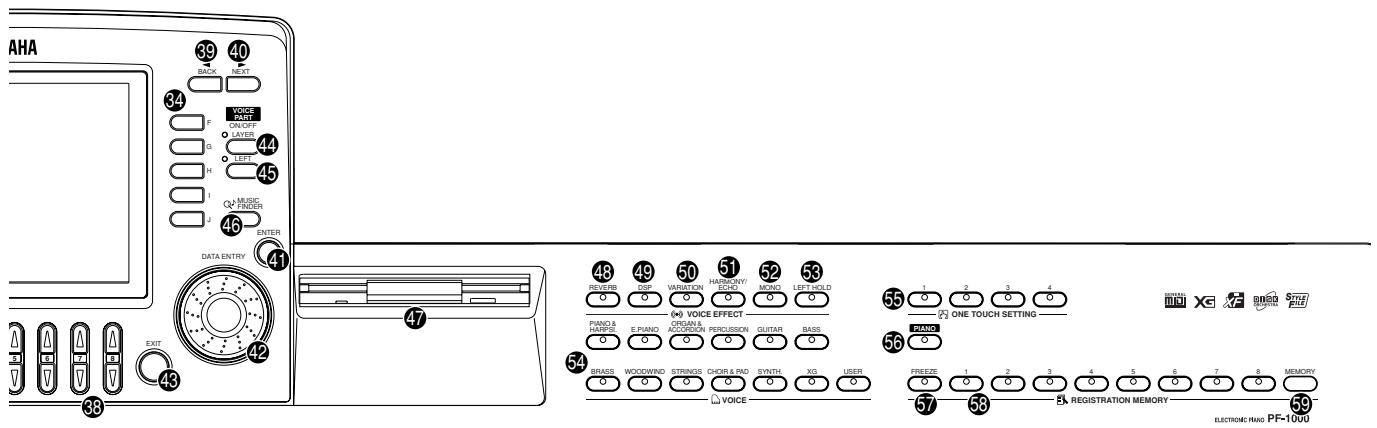

VOICE

54 VOICE buttons.....P. 54

ONE TOUCH SETTING

55 [1] - [4] buttons (ONE TOUCH SETTING)P. 67

PIANO Setting

56 [PIANO] buttonP. 55

REGISTRATION MEMORY

57 [FREEZE] buttonP. 84

58 [1] - [8] buttons (REGISTRATION MEMORY).....P. 82

59 [MEMORY] button.....P. 82

Connectors

60 [VIDEO OUT] jackP. 142

61 AUX IN [L / L+R] [R] jacksP. 142

62 AUX OUT [L / L+R] [R] jacksP. 142

63 AUX OUT (LEVEL FIXED) [L] [R] jacks.....P. 142

64 [PHONES] jacksP. 141

65 [AC INLET]P. 16

66 [PEDAL] jack.....P. 16

67 [AUX PEDAL] jackP. 143

68 MIDI [THRU] [OUT] [IN] terminalsP. 143

69 [HOST SELECT] switch.....P. 143

70 [TO HOST] terminal.....P. 144

POWER

71 [ON / OFF] button (POWER)P. 17

Microphone Connectors

72 [INPUT VOLUME] knobP. 141

73 [MIC / LINE IN] jack.....P. 141

74 [MIC LINE] switchP. 141

Pedals

75 Left pedal.....P. 58

76 Sostenuto pedal.....P. 58

77 Damper pedal.....P. 58

The Panel Logos

The logos printed on the PF-1000 panel indicate standards/formats it supports and special features it includes.

GM System Level 1

“GM System Level 1” is an addition to the MIDI standard which guarantees that any data conforming to the standard will play accurately on any GM-compatible tone generator or synthesizer from any manufacturer.

XG Format

XG is a new Yamaha MIDI specification which significantly expands and improves on the “GM System Level 1” standard with greater voice handling capacity, expressive control, and effect capability while retaining full compatibility with GM. By using the PF-1000’s XG voices, it is possible to record XG-compatible song files.

XF Format

The Yamaha XF format enhances the SMF (Standard MIDI File) standard with greater functionality and open-ended expandability for the future. The PF-1000 is capable of displaying lyrics when an XF file containing lyric data is played. (SMF is the most common format used for MIDI sequence files. The PF-1000 is compatible with SMF Formats 0 and 1, and records “song” data using SMF Format 0.)

Disk Orchestra Collection

The DOC voice allocation format provides data playback compatibility with a wide range of Yamaha instruments and MIDI devices.

Style File Format

The Style File Format (SFF) is Yamaha’s original style file format, which uses a unique conversion system to provide high-quality automatic accompaniment based on a wide range of chord types. The PF-1000 uses the SFF internally, reads optional SFF style disks, and creates SFF styles using the Style Creator feature.

Quick Guide

Playing the Demos

Reference
on page 52

The PF-1000 features an extensive variety of Demo songs, that showcase its rich, authentic voices and its dynamic rhythms and styles.

What's more, there's a special selection of Demo functions. These take you through a hands-on journey of all the important features and functions of the instrument — letting you see firsthand how to effectively use the PF-1000 in your own music.

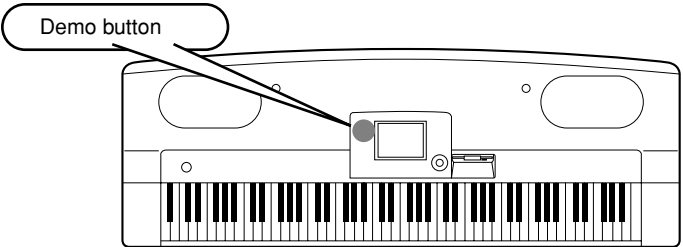

1 Pressing the [DEMO] button automatically plays back the Demo songs at random.



2 Press the [BACK]/[NEXT] button to select the Demo categories.

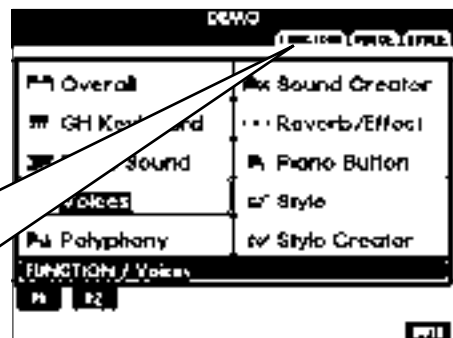
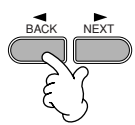

For this example, FUNCTION is selected. Function Demos demonstrate many of the different functions on the PF-1000.

NOTE
Voice Demos showcase the voices of the PF-1000. Style Demos introduce you to the rhythms and accompaniment styles of the PF-1000 (page 52).

3 Press any of the [A] to [J] buttons or [8▼] (AUTO) button (FUNCTION page only) to select the Demo songs. For this example, press the [8▼] (AUTO) button. All of the function demos are played back in sequence.

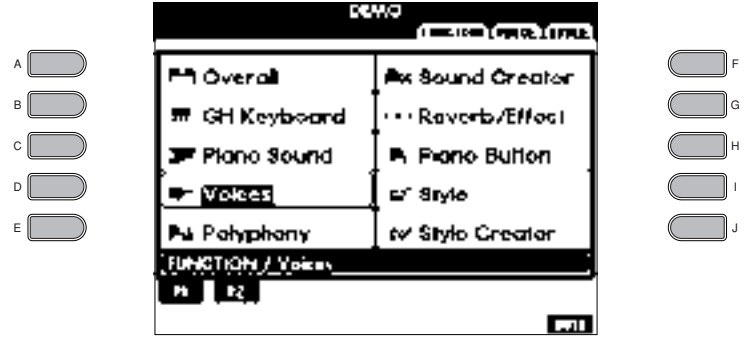

NOTE
For details about the Demos, refer to page 52.

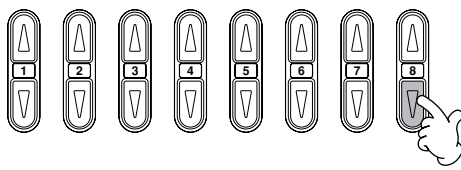

Press the [EXIT] button to exit from the demo mode and return to the MAIN display when you've finished playing the demo songs.

When you're done with the Demos, you can get to know your PF-1000 even better with these functions:

- Preset Song (Song Book) playback (page 21)
- Disk Song Playback (page 21)
- Short demo playback of the selected voice (in the Voice Open display; page 26).

Song Playback

Reference on page 73

Here's where all of the amazing voices, effects, rhythms, styles and other sophisticated features of the PF-1000 come together — in songs!

As you heard in the Demos, the PF-1000 contains many built-in recordings. But there's more. Check out the included disk or call up the Song Open (PRESET) display. And there's an even greater wealth of song material you can enjoy with your PF-1000 — in commercially available software.

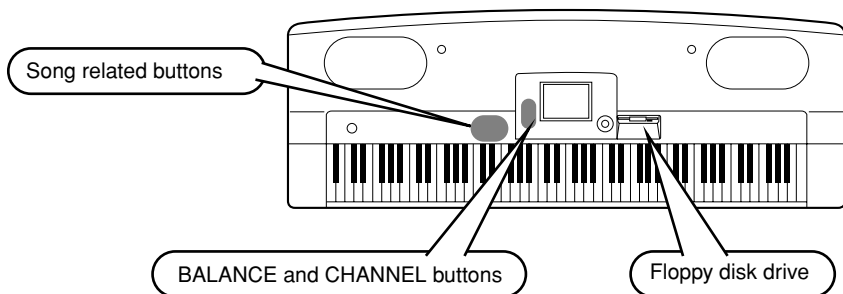

NOTE
Make sure that the Language setting for the instrument (page 140) is the same as that of the file name of the song that you are playing back.

The following songs are compatible for playback on the PF-1000. Refer to pages 73, 148 for more details on the logos.



Disks bearing this logo contain song data for voices defined in the GM standard.



Disks bearing this logo contain song data using the XG format, an extension of the GM standard that provides a wider variety of voices and more comprehensive sonic control.



Disks bearing this logo contain song data for voices defined in Yamaha's DOC format.

NOTE
Songs containing a large amount of data may not be able to be read properly by the instrument, and as such you may not be able to select them. The maximum capacity is about 200–300KB, however this may differ depending on the data contents of each song.

Playback of Songs

- ▶ **1** If you want to play back a disk song, insert an appropriate disk containing song data into the disk drive.

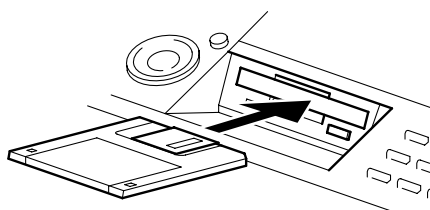

CAUTION
• Make sure to read the section "Using the Floppy Disk Drive (FDD) and Floppy Disks" on page 6.

Song Playback

- ▶ **2** Press the [A] button to call up the Song Open display.
If the MAIN screen is not displayed, press the [DIRECT ACCESS] button followed by the [EXIT] button.

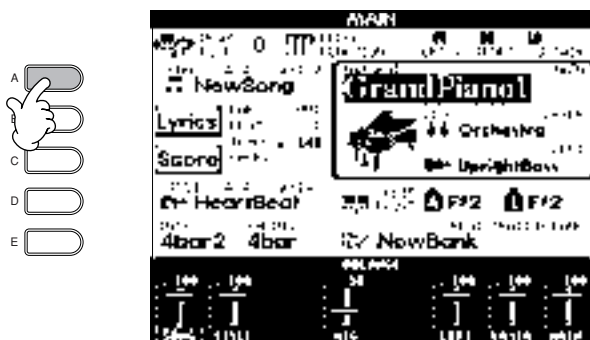

NOTE
From the MAIN display (the display shown when the power is turned on), you can select songs, voices, accompaniment styles, etc.

PRESET

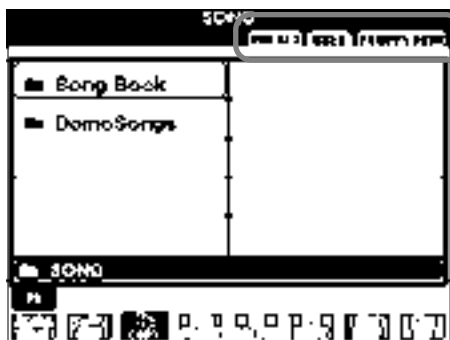

FLOPPY DISK



Press the [BACK]/[NEXT] button to select the drive.

- ▶ **3** PRESET only
Press the [A] button to select the preset songs (Song Book) folder.

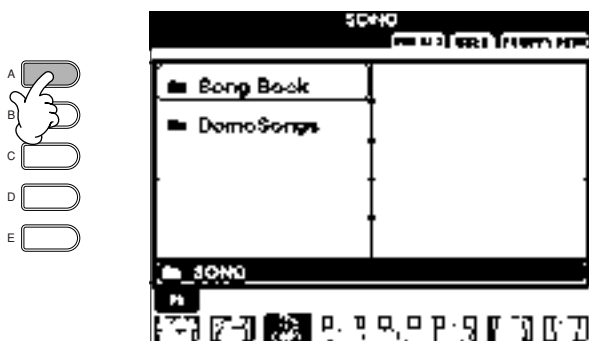

▶ **4** Press one of the [A] to [J] buttons to select a song file.

▶ **5** Press the SONG [START/STOP] button to start playback.

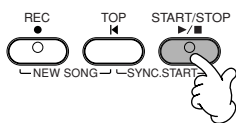

NOTE

- To rewind or fast forward to the playback point of the song, press the [REW] or [FF] button.
- With song data software (Standard MIDI format 0) that includes lyrics, you can view the lyrics on the display during playback. You can also view the score. See pages 78 and 81 for details.

▶ **6** While the song is playing, try using the Mute function to turn certain instrument channels off or on — letting you craft dynamic arrangements on the fly!

- 1) Press the [CHANNEL ON/OFF] button.
- 2) Press the [1 - 8▲▼] button corresponding to the channel you wish to turn on or off.

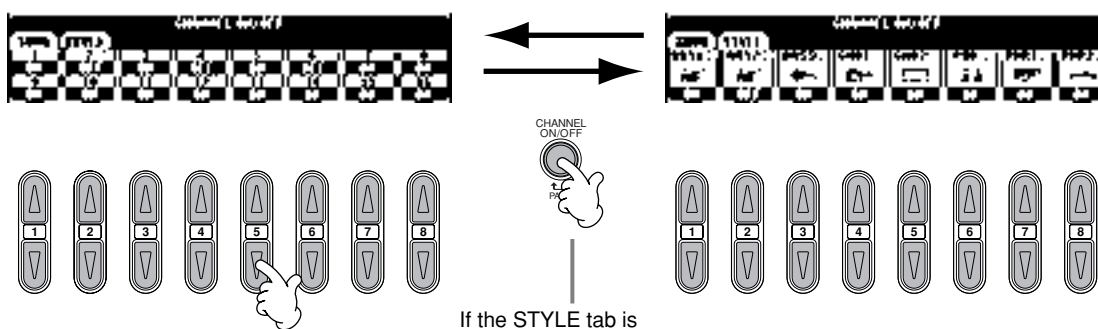

If the STYLE tab is selected, press this button again.

Song Playback

- ▶ **7** Finally, take the producer's seat and try your hand at mixing. These Balance controls let you adjust the levels of the individual parts — the song, the style, your singing, and your playing.

- 1) Press the [BALANCE] button.
- 2) Press the [1 - 8▲▼] button corresponding to the part of which the volume you wish to adjust.

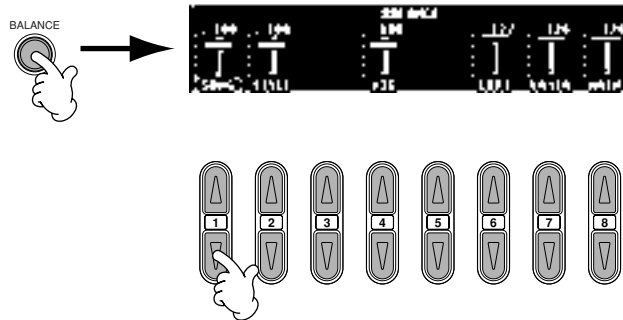

NOTE

You can call up a full set of mixing controls by pressing the [MIXING CONSOLE] button (page 116).

- ▶ **8** Press the SONG [START/STOP] button to stop playback.

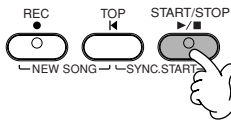

NOTE

- The [FADE IN/OUT] button (page 65) can be used to produce smooth fade-ins and fade-outs when starting and stopping the song, as well as the accompaniment.

Playing Voices

Reference on page 54

The PF-1000 features a stunning variety of over 800 dynamic, rich and realistic voices. Try playing some of these voices now and hear what they can do for your music. Here, you'll learn how to select individual voices, combine two voices in a layer, and split two voices between your left and right hands.

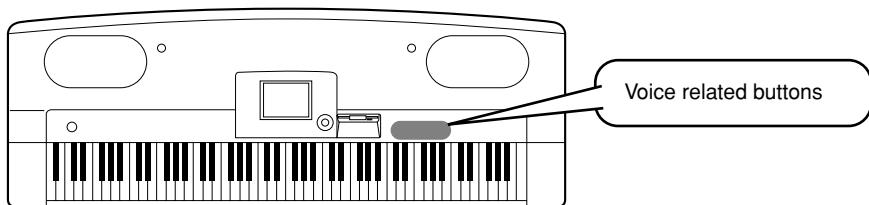

Playing a Voice

- ▶ **1** Press the [F] button to call up the menu for selecting the MAIN voice. If the MAIN screen is not displayed, press the [DIRECT ACCESS] button followed by the [EXIT] button.

NOTE
The voice you're selecting here belongs to the MAIN part, and is called the MAIN voice. (See page 56 for more information.)

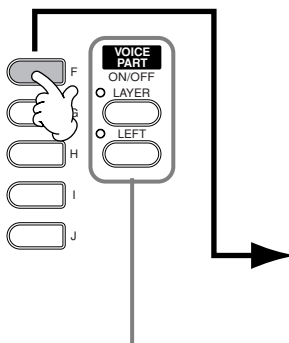
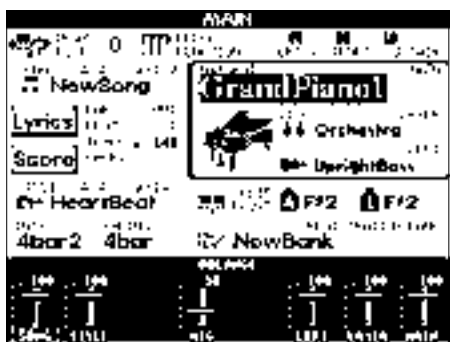

You'll want to hear the MAIN voice all by itself — so make sure that the LAYER and LEFT parts are turned off.



- ▶ **2** Select a voice group.

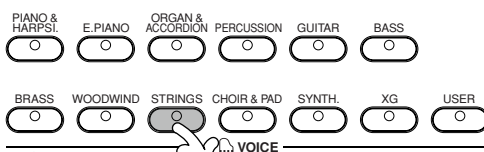

For this example, STRINGS is selected.



Press the [BACK]/[NEXT] button to select the memory location of the voice. For this example, PRESET is selected.

Playing Voices

▶ 3 Select a voice.

For this example, "Orchestra" is selected.

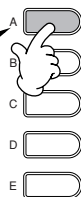

NOTE
You can instantly jump back to the Main display by "double-clicking" on one of the [J] - [J] buttons.

Press the corresponding buttons to select the other pages — and discover even more voices.

Press the [8▲] button to start the Demo for the selected voice. To stop the Demo, press this button again. There's more to the Demo features than just voices, though—for more information, see page 52.

▶ 4 Play the voices.

Naturally, you can play the voice yourself from the keyboard, but you can also have the PF-1000 demonstrate the voice for you. Simply press the [8▲] button from the display above, and a Demo of the voice plays automatically.

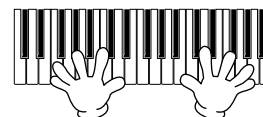

Playing Two Voices Simultaneously

▶ 1 Press the VOICE PART ON/OFF [LAYER] button to turn the LAYER part on.

▶ 2 Press the [G] button to select the LAYER part.



▶ 3 Select a voice group.

Here, we'll select a lush pad to fill out the sound. Call up the "CHOIR & PAD" group.

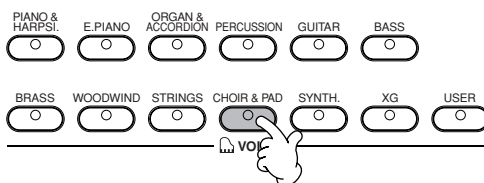

▶ 4 Select a voice.

For example, select "Hah Choir."

▶ 5 Play the voices.

Now, you can play two different voices together in a rich sounding layer — the MAIN voice you selected in the previous section, plus the new LAYER voice you've selected here.



And that's just the beginning. Check out these other voice-related features:

- Instant setup of the PF-1000 for piano play — with the press of a single button (page 55).
- Create your own original voices — quickly and easily — by changing the settings of existing voices (page 85).
- Set up your favorite panel settings — including voices, styles, and more — and call them up whenever you need them (page 82).

Playing Different Voices with the Left and Right Hands

▶ **1** Press the VOICE PART ON/OFF [LEFT] button to turn the LEFT part on.

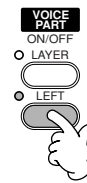

▶ **2** Press the [H] button to select the LEFT part.

▶ **3** Select a voice group. Here, we'll select the "STRINGS" group — so that you can play rich, orchestral chords with your left hand.

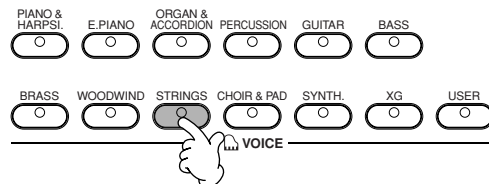

▶ **4** Select a voice, then press the [EXIT] button to return to the MAIN display. For example, select "Symphon. Str."

▶ **5** Press the [I] button to call up the SPLIT POINT display. From here, you can set the particular key on the keyboard that separates the two voices — called the Split Point. To do this, simultaneously hold down the [F] or [G] button and press the desired key on the keyboard. (For more information, see page 127.)



▶ **6** Play the voices. The notes you play with your left hand sound one voice, while the notes you play with your right sound a different voice (or voices).

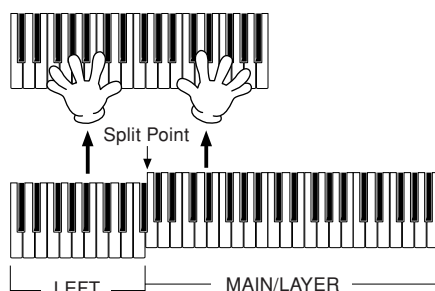

MAIN and LAYER voices are meant to be played with the right hand. The LEFT voice is played with the left hand.

▶ **7** Press the [EXIT] button to return to the MAIN display.



Playing Styles

The PF-1000 has a huge variety of musical “styles” that you can call upon to back up your own performance. They give you anything from a simple, yet effective piano backing or percussion accompaniment to a full band or orchestra.

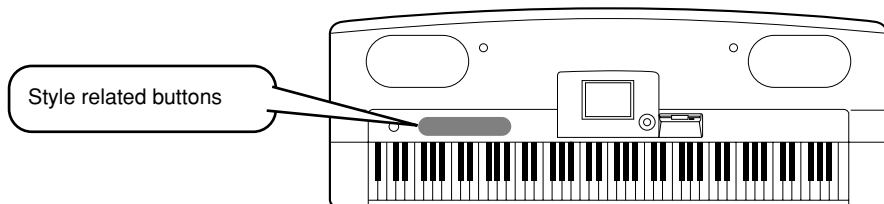

Playing a style

▶ 1 Select a style group and a style.

If the MAIN screen is not displayed, press the [DIRECT ACCESS] button followed by the [EXIT] button.

▶ 2 Turn ACMP on.

The specified left-hand section of the keyboard becomes the “Auto Accompaniment” section, and chords played in this section are automatically detected and used as a basis for fully automatic accompaniment with the selected style.

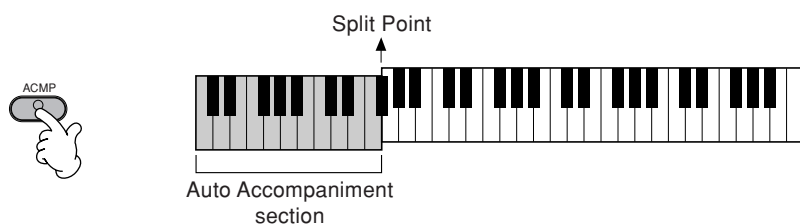

NOTE

- The point on the keyboard that separates the auto accompaniment section and the right-hand section of the keyboard is called the “split point.” Refer to page 127 for instructions on setting the split point.

▶ 3 Turn SYNC.START on.



- ▶ **4** As soon as you play a chord with your left hand, the style starts.
For this example, play a C major chord (as shown below).

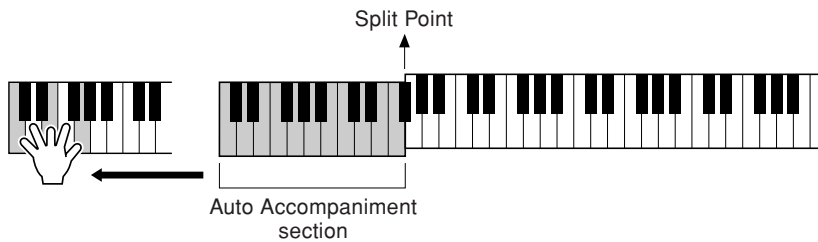

- ▶ **5** Change the tempo by using the TEMPO[-] [+] buttons if necessary.
Simultaneously press the TEMPO [-] [+] buttons to return the tempo to its original setting. Press the [EXIT] button to leave the TEMPO display.
- ▶ **6** Try playing other chords with your left hand.
For information on how to enter chords, see “Chord Fingerings” on page 62.
- ▶ **7** Press the STYLE CONTROL [START/STOP] button to stop the style.

NOTE
The Tempo can also be adjusted by using the [TAP TEMPO] button (page 51).

And there’s much more. Check out these other style-related features:

- Easily create your own original styles (page 106).
- Set up your favorite panel settings — including styles, voices, and more — and call them up whenever you need them (page 82).

Embellish and enhance your melodies — with the automatic Harmony and Echo effects

This powerful performance feature lets you automatically add harmony notes to the melodies you play with your right hand — based on the chords you play with your left. Tremolo, Echo, and other effects are available, too.

- 1 Turn HARMONY/ECHO on.

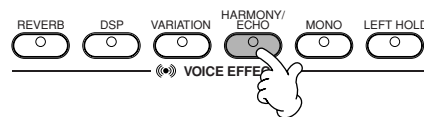

- 2 Turn ACMP on (page 28).
- 3 Play a chord with your left hand and play some notes in the right-hand range of the keyboard.

The PF-1000 has various Harmony/Echo types (page 132).
The Harmony/Echo type may change according to the selected MAIN voice.

NOTE
For details about Harmony/Echo types, refer to the separate Data List.

- Harmony/Echo is just one of the many Voice Effects you can use. Try out some of the other effects and see how they can enhance your performance (page 57).

Style Sections

Each style in the auto accompaniment is made up of “sections.” Since each section is a rhythmic variation of the basic style, you can use them to add spice to your performance and mix up the beats — while you’re playing. Intros, Endings, Main patterns, and Breaks — they’re all here, giving you the dynamic elements you need to create professional-sounding arrangements.

INTRO	This is used for the beginning of the song. When the intro finishes playing, accompaniment shifts to the main section.
MAIN	This is used for playing the main part of the song. It plays an accompaniment pattern of several measures, and repeats indefinitely until another section’s button is pressed.
BREAK	This lets you add dynamic variations and breaks in the rhythm of the accompaniment, to make your performance sound even more professional.
ENDING	This is used for the ending of the song. When the ending is finished, the auto accompaniment stops automatically.

▶ **1-4** Use the same operations as in “Playing a style” on pages 28 and 29.

▶ **5** Press the [INTRO] button.

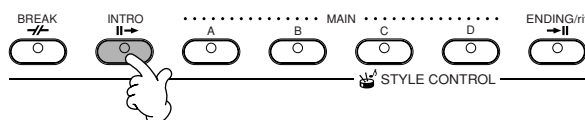

▶ **6** As soon as you play a chord with your left hand, the Intro starts.
For this example, play a C major chord (as shown below).

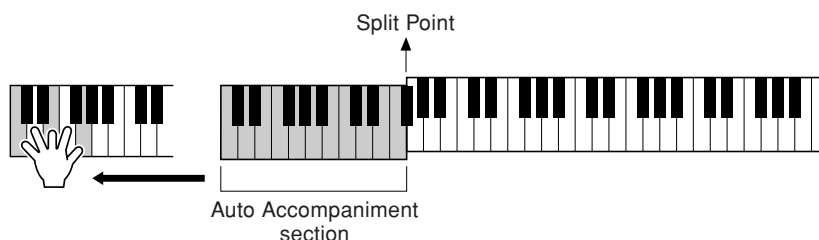

When the playback of the intro is finished, it automatically leads into main section.

▶ **7** Press any of the MAIN [A] to [D] buttons or [BREAK] button as desired. (See the Accompaniment Structure on the next page.)

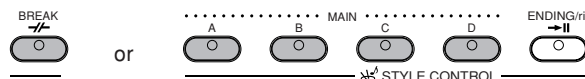

▶ **8** Press the [AUTO FILL IN] button to add a fill-in, if necessary.
Fill-in patterns play automatically between each change in the Main sections.



▶ **9** Press the [ENDING] button.
This switches to the ending section. When the ending is finished, the style automatically stops.

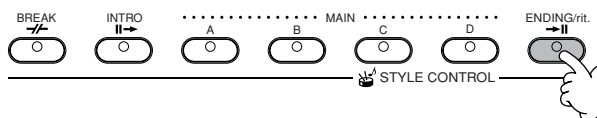

■ Accompaniment Structure

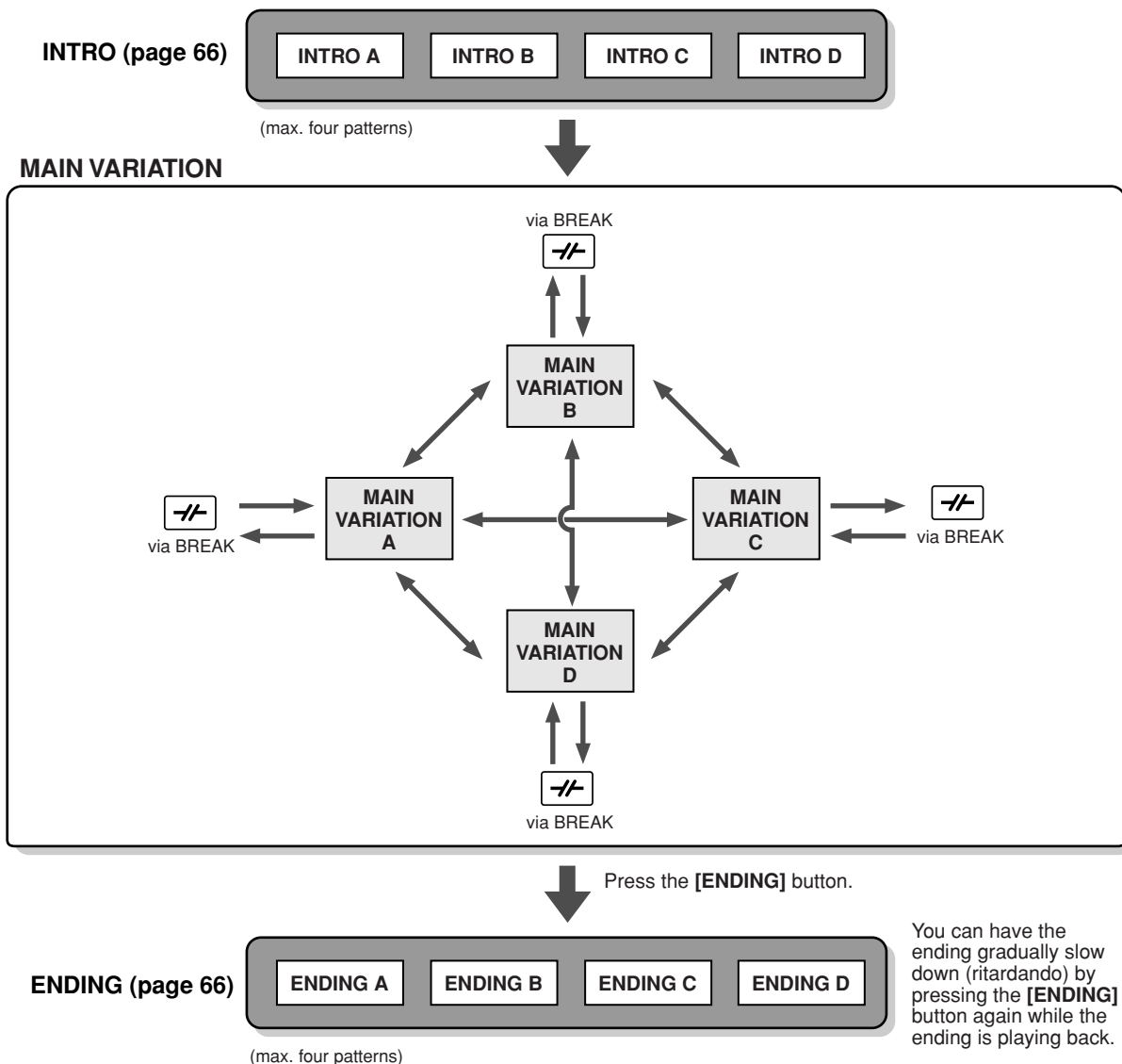



You can have the ending gradually slow down (ritardando) by pressing the [ENDING] button again while the ending is playing back.

NOTE

- An Intro doesn't necessarily have to be at the beginning! If you want, you can play an Intro section in the middle of your performance by simply pressing the [INTRO] button at the desired point.
- Watch your timing with the Break sections. If you press a [BREAK] button too close to the end of the measure (i.e., after the final eighth note), the Break section starts playing from the next measure. This also applies to the Auto Fill-in.
- Mix up your intros and use any of the other sections to start the style, if you want.
- If you want to come back into the style right away after an Ending, simply press the [INTRO] button while the Ending section is playing.
- If you press the [BREAK] button while the ending is playing, the break will immediately start playing, continuing with the main section.

Other Controls

<p>FADE IN/OUT</p> 	<p>The [FADE IN/OUT] button can be used to produce smooth fade-ins and fade-outs (page 65) when starting and stopping the style.</p>
<p>TAP TEMPO</p> 	<p>The style can be started at any tempo you desire by "tapping" out the tempo with the [TAP/TEMPO] button. For details, see page 51.</p>
<p>SYNC.STOP</p> 	<p>When Synchro Stop is on, you can stop and start the style anytime you want by simply releasing or playing the keys (in the Auto Accompaniment section of the keyboard). This is a great way to add dramatic breaks and accents to your performance. For details, see page 65.</p>

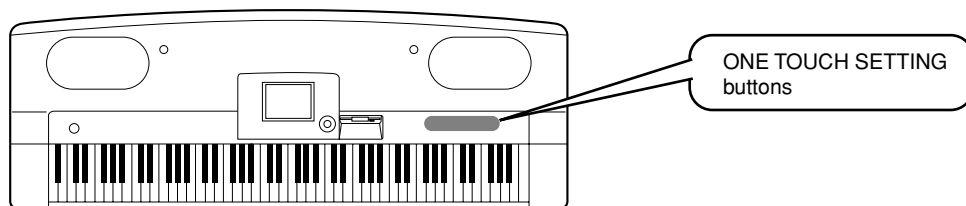

One Touch Setting

One Touch Setting is a powerful and convenient feature that automatically calls up the most appropriate panel settings (voice number, etc.) for the currently selected style, with the touch of a single button. This is a wonderful way to instantly reconfigure all the settings on the PF-1000 to match the style you want to play.

▶ **1** Select a style (page 28).

▶ **2** Press one of the [ONE TOUCH SETTING] buttons.

Not only does this instantly call up all the settings (voices, effects, etc.) that match the current style (see page 67) — it also automatically turns on ACMP and SYNC. START, so that you can immediately start playing the style.

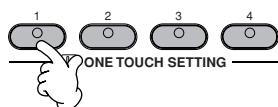

▶ **3** As soon as you play a chord with your left hand, the auto accompaniment starts.

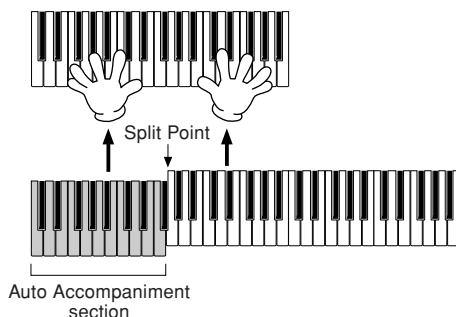

▶ **4** Play melodies with your right hand and play various chords with your left hand.

▶ **5** Try out other One Touch Setting setups.



You can also create your own One Touch Setting setups. For details, refer to page 68.

- Here's another way to further automate musical changes and spice up your performance: Use the convenient OTS (One Touch Setting) Link function to automatically change One Touch Settings when you select a different Main section (page 68).

Music Finder

Reference on page 69

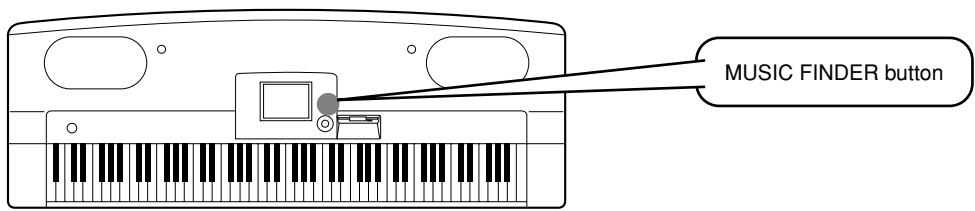

If you want to play in a certain song but don't know which style and voice settings would be appropriate, the convenient Music Finder can help you out. Simply select the song name from the Music Finder and the PF-1000 automatically makes all appropriate panel settings to let you play in that music style!

Using the Music Finder

- ▶ **1** Press the [MUSIC FINDER] button.



- ▶ **2** Select a record.

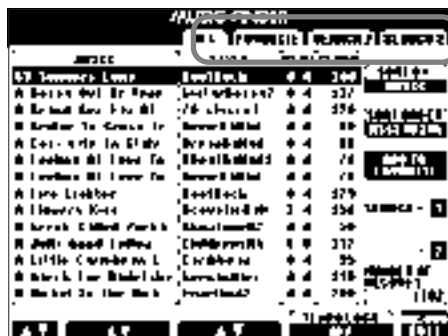

Press the [BACK]/[NEXT] button to select the desired page of records. For this example, ALL is selected.

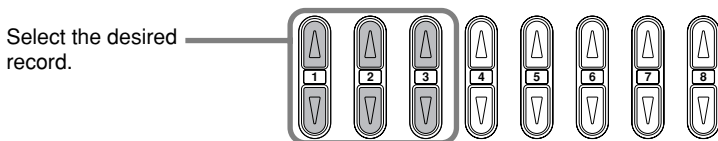

For this example, press the [1 - 3▲▼] button to select a record by song title.

- ▶ **3** Play along with the style playback.

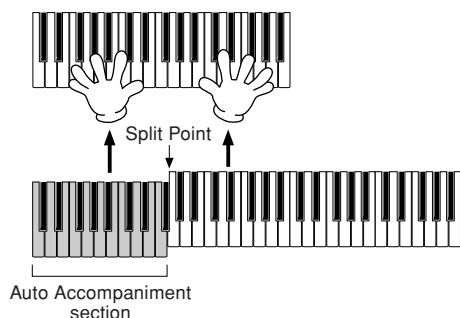

NOTE
You can also have the voice and other important settings change automatically with the style changes. To do this, turn on OTS LINK (page 68) and set the OTS LINK TIMING (page 127) to "REAL TIME."

Press the [EXIT] button to return to the MAIN display.

Searching the Music Finder Records

The Music Finder is also equipped with a convenient search function that lets you enter a song title or keyword — and instantly call up all the records that match your search criteria.

- **1** Press the [MUSIC FINDER] button.



- **2** Press the [I] button to call up the MUSIC FINDER SEARCH 1 display.

NOTE
The results of Search 1 and 2 appear in the correspondingly numbered SEARCH 1/2 displays.

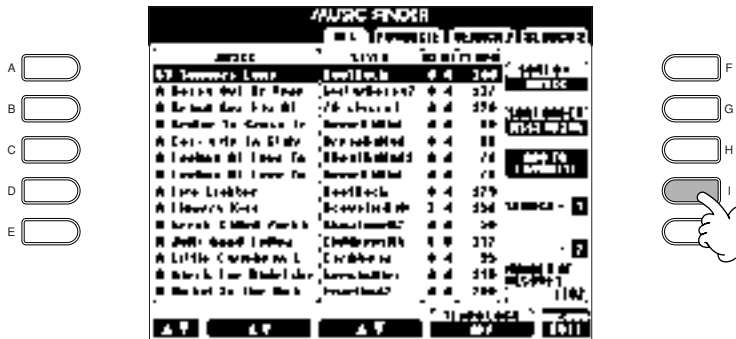

- 4** For this example, press the [A] button to call up the display for inputting the song title.

For this example, ANY is selected.



NOTE
Refer to page 45 for instructions on entering characters.

- 3** Press the [F], [G] and [H] to clear the previous conditions, if necessary.

- 5** Enter the song title, then press the [8▲] (OK) button.

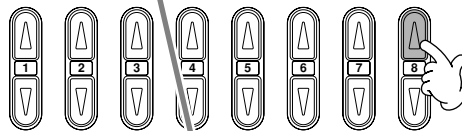

For this example, ALL is selected.

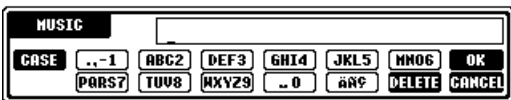

- 6** Press the [8▲] (START SEARCH) button. The search function calls up all records that contain the entered word or words.

- ▶ **7** Select a record (see step #2 on page 33) and play along with the style playback.

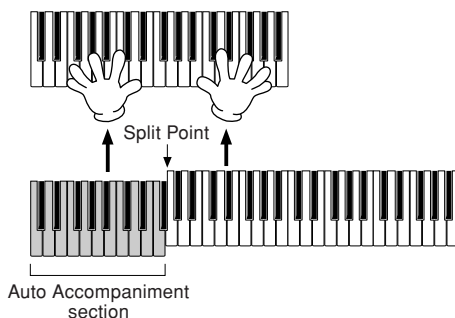

Press the [EXIT] button to return to the MAIN display.

You can also create your own Music Finder setups and save them to floppy disk (pages 38 and 44).

Saving and Recalling Music Finder Data

To save your Music Finder data, call up the MUSIC FINDER Open/Save window from the SYSTEM RESET page (page 140) of the UTILITY display, and follow the same procedure as that in the Open/Save window for Voice (page 38, 44). To recall the saved data, execute the appropriate operation from the MUSIC FINDER's Open/Save window. Records can be replaced or added (page 71).

In the instructions above, all Music Finder data is handled together. Besides this, when you save or load style files, the Music Finder data that uses the relevant style file(s) is stored or added automatically. When you copy or move a style file on a floppy disk to the USER drive (page 42, 43), the record which was recorded when storing the relevant style is automatically added to the PF-1000.

- In the example above, you specified a song title, but you can also look for relevant records by keyword or music genre — for example, Latin, 8-beat, etc. (page 70).

Playing and Practicing with the Songs

Reference on page 73

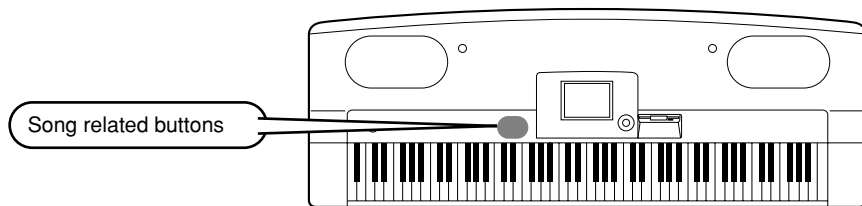

Playing Along with the PF-1000

In this section, try using the PF-1000's song playback features to cancel or mute the right-hand melody while you play the part yourself. It's like having a very talented and versatile playing partner accompany you while you perform.

▶ **1-4** Use the same operations as in "Song Playback" on pages 21 - 23.

▶ **5** Press the [TRACK 1] button to cancel the right hand melody part.



NOTE
To cancel the left hand part, press the [TRACK 2] button

▶ **6** If you want to have the notation displayed as you play, press the [C] button. If you want to see the lyrics, press the [B] button.

If the MAIN screen is not displayed, press the [DIRECT ACCESS] button followed by the [EXIT] button.

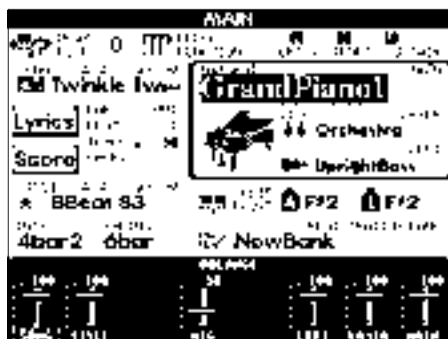
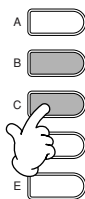

NOTE
If the selected song does not contain lyric data, lyrics are not displayed.

▶ **7** Press the SONG [START/STOP] button and play the part.

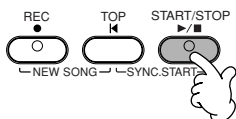

▶ **8** Press the SONG [START/STOP] button to stop playback.

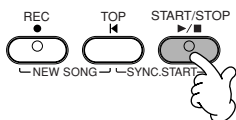

NOTE

- If you want to start the song right away without an intro, use the Sync Start function. To set Sync Start to standby, simultaneously hold down the [TOP] button and press the SONG [START/STOP] button. Song playback starts automatically the moment you start playing the melody.
- If you can hear the PF-1000 playing the melody part as well, check the channel setting for the melody part in the song data, and change the channel assigned to Track 1 (page 126). You can also change the song channel itself permanently (page 101).

Recording

The PF-1000 lets you record, too — quickly and easily. Try out the Quick Recording feature now and capture your keyboard performance.

- ▶ **1-3** Select a voice for recording. Use the same operations as in “Playing a Voice” on pages 25, 26.

- ▶ **4** Press the [REC] and [TOP] buttons simultaneously to select “New Song” for recording.

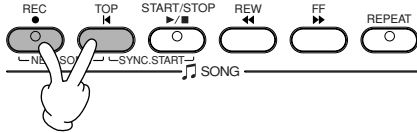

- ▶ **5** Simultaneously hold down the [REC] button and press the [TRACK1] button.



- ▶ **6** Recording starts as soon as you start playing the keyboard.

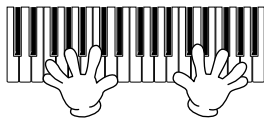

- ▶ **7** When you’ve finished recording, press the [REC] button.

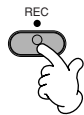

- ▶ **8** To hear your newly recorded performance, return the song to the beginning by using the [TOP] button and press the SONG [START/STOP] button.

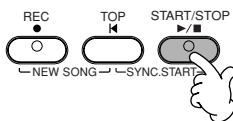

- ▶ **9** Save the recorded data as required (pages 38, 44).

CAUTION

The recorded data will be lost if you turn off the power. To keep your important recordings, you’ll need to save them to the User drive or floppy disk.

Basic Operations — Organizing Your Data

The PF-1000 utilizes a variety of data types — including voices, accompaniment styles, songs and registration memory settings. Much of this data is already programmed and contained in the PF-1000; you can also create and edit your own data with some of the functions on the instrument.

All this data is stored in separate files — just as is done on a computer.

Here, we'll show you how to use the basic operations of the display controls in handling and organizing the data of the PF-1000 in files and folders.

Files can be opened, saved, named, moved, or deleted in their respective Open/Save displays. You can select these displays according to their respective file types, as well: Song, Voice, Style, etc. Moreover, you can organize your data efficiently by putting various files of the same type into a single folder.

The Open/Save displays for Song, Voice, Style, and Registration Bank can be called up from the MAIN display (the display shown when the power is turned on) by pressing the appropriate [A] - [J] button.

Open/Save display for Song (page 74)

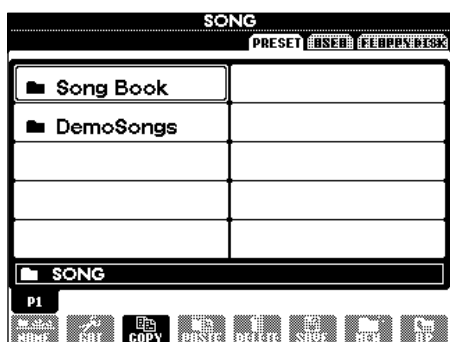

handles the Song files.

Open/Save display for Voice (page 54)



handles the Voice files.

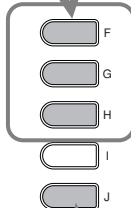
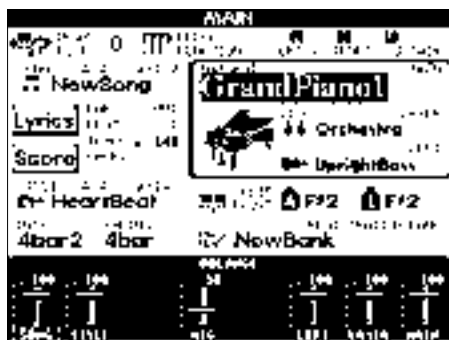
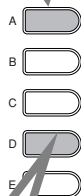

NOTE

The following Open/Save display types are also available; however, these are selected from displays other than the MAIN display (page 140).

- SYSTEM SETUP
- MIDI SETUP
- USER EFFECT
- MUSIC FINDER

NOTE

If the MAIN screen is not displayed, press the [DIRECT ACCESS] button followed by the [EXIT] button.

Open/Save display for Style (page 59)



handles the Style files.

Open/Save display for Registration Bank (page 83)

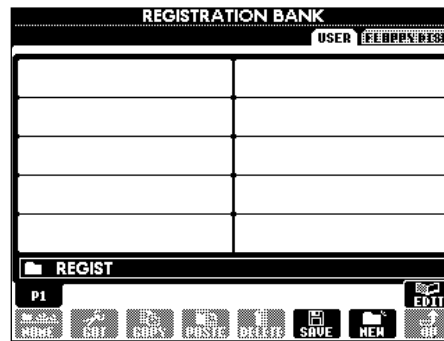

handles the Registration Bank files.

Example — Open/Save display for Voice

Each Open/Save display consists of PRESET, USER, and FLOPPY DISK drive pages.

PRESET drive

The files that are pre-programmed and installed internally to the PF-1000 are kept here. Preset files can be loaded but cannot be re-written. However, you can use a preset file as a basis for creating your own original file (which can be saved in the USER or FLOPPY DISK drive).

USER drive

Files kept here are those containing your own original data, created or edited using the various functions of the PF-1000. They are stored internally to the PF-1000.

FLOPPY DISK drive

You can also store your original data to floppy disk. Commercially available disk software can also be called up here. Naturally, these files are available only when the appropriate disk is inserted in the floppy disk drive.



Changes drives among PRESET, USER and FLOPPY DISK.

Calls up the upper level directory page. In this example, the voice folder selection page can be called up.

File

All data, both pre-programmed and your own original, are stored as "files."

Current Memory

"Current Memory" is the area where the voice is called up when you select a voice. Also it is the area where you edit your voice using the SOUND CREATOR function. Your edited voice should then be saved as a file in the USER or FLOPPY DISK drive. Recording songs (page 90) and creating accompaniment styles (page 106) are done within the current memory. Please make sure to properly save this data to the USER/FLOPPY DISK drive as a file or files. The data will be lost if you turn off the power without saving.

Selecting Files and Folders

Select a file shown in the display. In this example, we'll select a voice file.

First, press the VOICE [PIANO & HARPSI] button to call up the display containing the files.

This display ("Open/Save" display) is typical of those used to call up and store files (voice files).

The PF-1000 already contains a variety of voices in the PRESET section. You can store your own original voices created with the **Sound Creator** function to the **USER** or **FLOPPY DISK** section.

1 Select "PRESET," "USER," or "FLOPPY DISK" by using the [BACK][NEXT] button.

NOTE
When "JAPANESE" is selected for the Language parameter (pages 49, 140), and you change this to one of the western languages, the kanji and kana characters of the file name stored in the disk drive are changed to western characters. In the opposite case, special Latin characters and marks are changed into normal characters. Also, in the case of floppy disk data, text in the files are changed to characters that cannot be read by the instrument. Keep in mind that similar problems may occur when trying to access files originating or edited by a computer having a different language operating system. In general, be careful when switching languages — you risk not being able to access the data properly.

NOTE
Double-clicking the appropriate [A] - [J] button calls up the corresponding file and returns to the MAIN display.

NOTE
Highlighting the desired file and double-clicking the [ENTER] button calls up the corresponding file and returns to the MAIN display.

2 Use the [1▲] ~ [7▲] buttons to turn the pages.

When the amount of pages exceeds six, the bottom of the display changes as shown below.

3 Select the file/folder.

There are two ways to select the file/folder:

- **Press the [A] - [J] button.**
Press the letter button corresponding to the file/folder you wish to call up. (In the example display shown above, the voice files are shown.)
- **Use the [DATA ENTRY] dial and the [ENTER] button.**
When you turn the [DATA ENTRY] dial, the highlight moves among the available files/folders. Highlight the desired file or folder (voice files are shown in the example above) and press the [ENTER] button to call up the selected item.

END Press the [EXIT] button to go back to the MAIN display.
You can go back to the previous display by pressing the [EXIT] button.

Exiting from small pop-up windows
You can also exit from small pop-up windows (such as in the illustration below) by pressing the [EXIT] button.

File/Folder-related Operations

Naming Files/Folders

You can assign names to files and folders. Any file/folder in the **USER** and **FLOPPY DISK** sections can be named or renamed. Execute the following steps when there is data in the User drive. If there are Preset files/folders you wish to rename, copy them beforehand (page 43) and use them as User files/folders.

- 1 Press the [1▼] (NAME) button (page 38).
The **NAME** display appears.

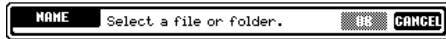

NOTE

A file/folder name can contain up to 50 half size letters (or 25 Hiragana and kanji letters), including the Icon ID (see the note below) and the extension.

- 2 Select the appropriate file/folder and press the [7▼](OK) button.
The currently selected file/folder is highlighted. To select another file/folder, press one of the [A] - [J] buttons.

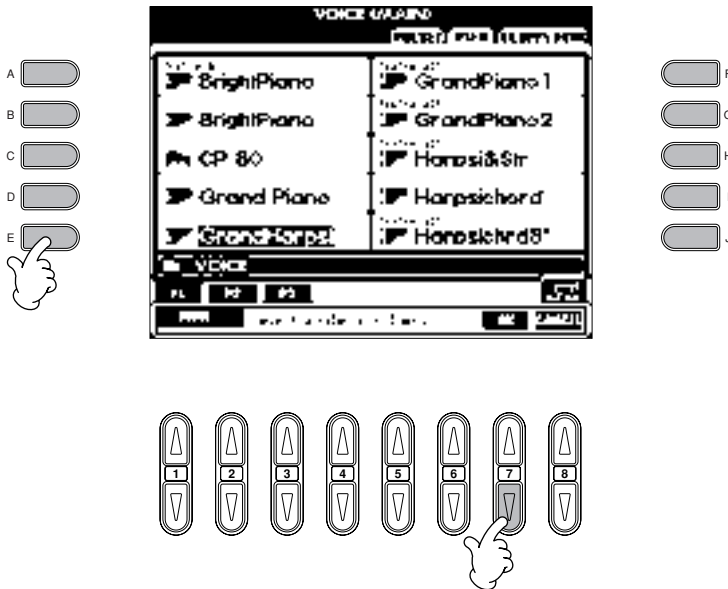

NOTE

The file name will appear on your computer as follows. If you change the Icon ID or the extension, the icon may not be properly recognized.

ABCDE.S002.MID
 File ID Icon ID Extension



Input the new name (page 45).



Press the [8▲] (OK) button. To cancel, press the [8▼] (CANCEL) button.

Moving Files/Folders

You can move files and folders as desired, for organizing your data. Any file/folder in the **USER** and **FLOPPY DISK** sections can be moved, using the cut-and-paste operation described below.

- 1 Press the [2▼] (CUT) button (page 38).
The CUT display appears.

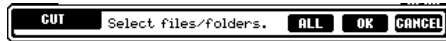

- 2 Select the desired file/folder for moving.

Select the appropriate file/folder and press the [7▼](OK) button. The currently selected file/folder is highlighted. To select another file/folder, press one of the [A] - [J] buttons.
Several files/folders can be selected together, even those from other pages. To release or cancel the selection, press the button of the selected file/folder again.
Press the [6▼] (ALL) button to select all the files/folders in the displayed page (USER/FLOPPY DISK). When the [6▼] (ALL) button is pressed the [6▼] button changes to "ALL OFF" button to release or cancel the selection.

- 3 Press the [7▼] (OK) button.

To stop the operation, press the [8▼] (CANCEL) button.

- 4 Call up the destination display.

Only the USER and FLOPPY DISK pages can be selected as the destination.



- Press the [4▼] (PASTE) button.

The file/folder you cut is now pasted at the destination.

NOTE

This operation cannot be used to directly move a file/folder from one floppy disk to another. If you want to do this, cut and paste the file or folder from the first floppy disk to the USER page, then change disks and paste it to the FLOPPY DISK page.

NOTE

All files/folders in a floppy disk can be copied to another disk in one batch (page 139).

NOTE

After being pasted, the files are automatically re-ordered in alphabetical order and displayed.

NOTE

About files/folders in a floppy disk

In the FLOPPY DISK page of the Open/Save display, only the files which can be handled in that Open/Save display will appear — even though a folder in a floppy disk can contain different kinds of files.

In the case of a folder cut-and-paste operation (for floppy disk), an entire folder can be cut; however, only the specific files which can be handled in the current Open/Save display will be pasted.

Copying Files/Folders

You can also copy files and folders as desired, for organizing your data. Any file/folder in the **PRESET**, **USER** and **FLOPPY DISK** sections can be copied, using the copy-and-paste operation described below.

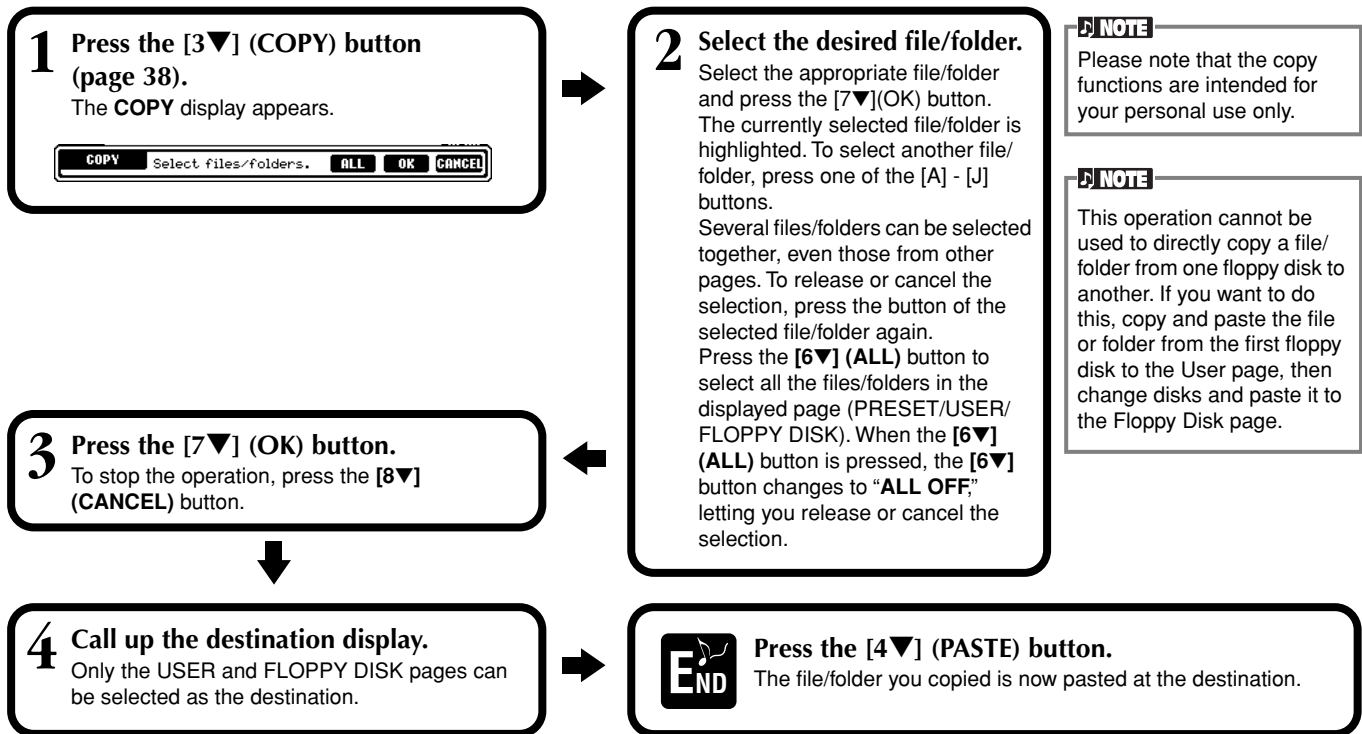

Deleting Files/Folders

You can also delete files and folders as desired, for organizing your data. Any file/folder in the **USER** and **FLOPPY DISK** sections can be deleted, using the operation described below.

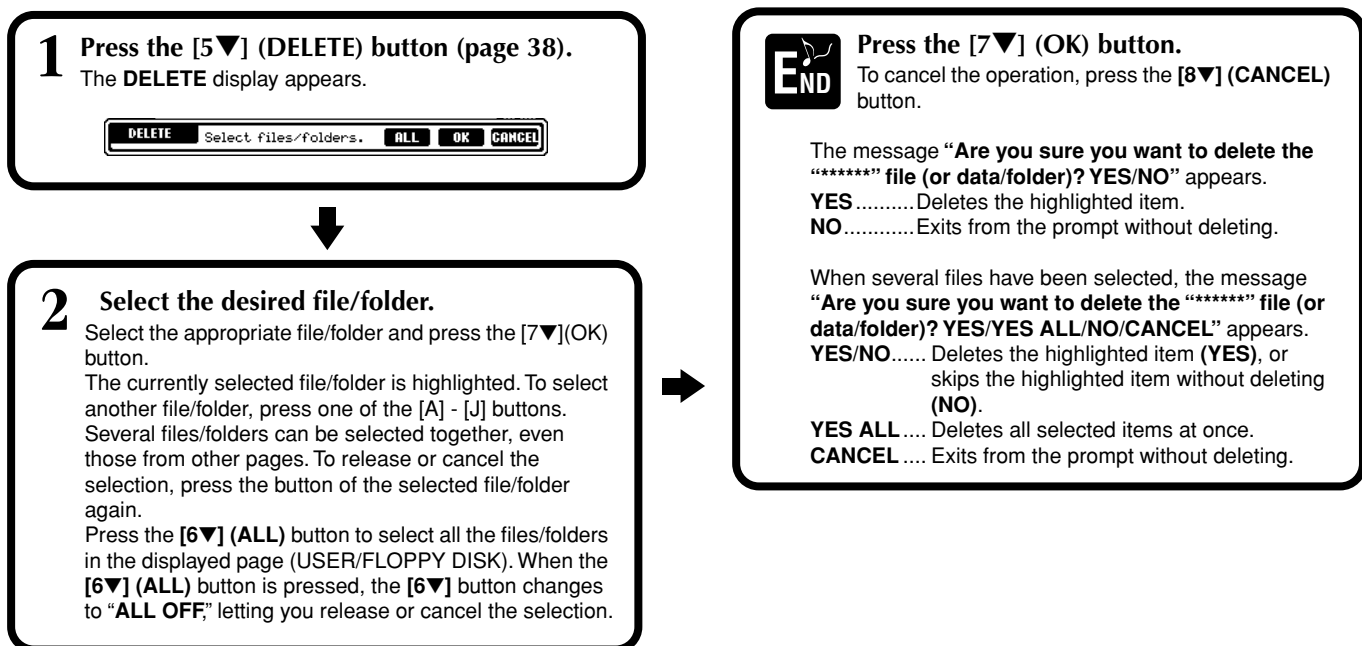

Saving Files

This operation lets you save the data (such as song and voice) you created in current memory (page 39) to files. The files can be saved only to the **USER** and **FLOPPY DISK** drives.

If the Open/Save display for the type of data you wish to save is not shown, first return to the MAIN display by pressing the **[DIRECT ACCESS]** button followed by the **[EXIT]** button. Then, press the appropriate button **[A]–[J]** from the MAIN display to call up the respective Open/Save display. Finally, call up the **USER** or **FLOPPY DISK** page (pages 38, 39).

NOTE

The internal memory capacity of the PF-1000 is about 580KB. Memory capacity for 2DD and 2HD floppy disks is about 720KB and 1.44MB, respectively. When you store data to these locations, all file types of the PF-1000 (Voice, Style, Song, Registration, etc.) are stored together.

NOTE

The files of commercially available DOC software and Yamaha Disklavier software, and their edited files on the PF-1000, can be stored in the **USER** page, but cannot be copied to another floppy disk.

1 Press the **[6▼]** (SAVE) button.

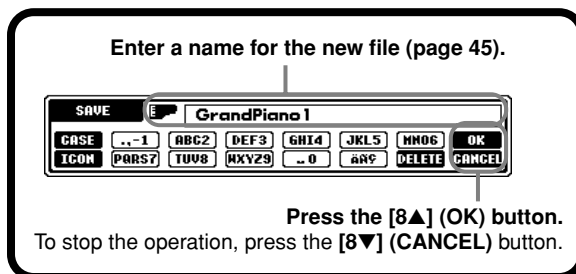

Organizing Files by Creating a New Folder

This operation lets you easily organize your various files into categories by creating a new folder for each category. Folders can only be created in the **USER** and **FLOPPY DISK** sections.

NOTE

Folder directories can contain up to four levels. The maximum total number of files and folders which can be stored is 800, but this may differ depending on the length of the file names. The maximum number of files which can be stored in a folder will be 250.

1 Call up the page to which you wish to create a new folder and press the **[7▼]** (NEW) button (page 38).

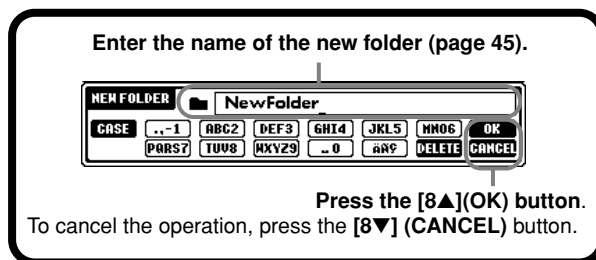

Displaying Upper Level pages

Press the **[8▼]** (UP) button to call up the upper level pages. For example, you can call up the folder level pages from the file level pages.

Entering Characters and Changing Icons

1 Press the **[1▼]** (NAME), **[6▼]** (SAVE), or **[7▼]** (NEW) button (page 38).



Change the type of character by using the **[1▲]** button.

If you select Japanese as the Language in the **FUNCTION** display (page 140), the following different types of characters and sizes can be entered:

- かな漢 (kana-kan)
Hiragana and kanji, marks (full size)
- カナ (kana)
Katakana (normal size), marks (full size)
- カナ (kana)
Katakana (half size), marks (half size)

- A B C** — Alphabet (capital and small letters, full size), numbers (full size), marks (full size)
- ABC** — Alphabet (capital and small letters, half size), numbers (half size), marks (half size)

If you've selected a language other than Japanese in the **FUNCTION** display (page 140), the following types of characters are available:

- CASE** — Alphabet (capital letters, half size), numbers (half size), marks (half size)
- case** — Alphabet (lowercase letters, half size), numbers (half size), marks (half size)

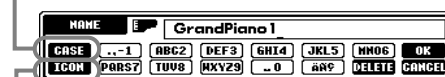

Call up the **ICON SELECT** display by pressing the **[1▼]** button. This lets you change the icon at the left of the file name.

Entering Characters

The instructions that follow show you how to enter characters in naming your files and folders. The method is much the same as inputting names and numbers to your cell phone.

- 1** Move the cursor to the desired position by using the [DATA ENTRY] dial.
- 2** Press the appropriate button, [2▲] - [7▲] and [2▼] - [6▼], corresponding to the character you wish to enter. Several different characters are assigned to each button, and the characters change each time you press the button. To actually enter the selected character, move the cursor or press another letter-input button. If you've entered a character by mistake, move the cursor to the character letter you wish to erase and press the [7▼] (DELETE) button. If you want to delete all of the characters on the line at once, press and hold down the [7▼] (DELETE) button for a while, or press the [8▼] (CANCEL) button. When the cursor appears in reverse display (highlight), only the reversed area is deleted.
- 3** To actually enter the new name, press the [8▲] (OK) button. To cancel the operation, press the [8▼] (CANCEL) button.

NOTE

The following half-size marks cannot be used in naming files and folders:
¥ \ / : * ? " < > |

■ Converting into Kanji (Japanese language)

This applies only if you are using the “かな漢 (kana-kan)” button (in Japanese). When the input “hiragana” characters are shown in reverse display (highlighted), press the [ENTER] button one or several times to convert the characters into the appropriate kanji. The reversed area can be changed by the [DATA ENTRY] dial. The converted area can be changed back to “hiragana” by the [7▼] (DELETE) button. The reversed area can be cleared at once by the [8▼] (CANCEL) button. To actually enter the change, press the [8▲] (OK) button or enter the next character. To enter the “hiragana” itself (without converting it), press the [8▲] (OK) button.

■ Entering special character marks (umlaut, accent, Japanese “ゝ” and “ゝ”)

Select a character to which a character mark is to be added and press the [6▼] button (before actual entry of the character.)

■ Entering miscellaneous characters (marks)

You can call up the mark list by pressing the [6▼] button, after actually entering a character by moving the cursor.

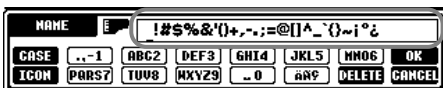

Move the cursor to the desired mark by using the [DATA ENTRY] dial, then press the [8▲] (OK) or [ENTER] button.

■ Entering numbers

First, select one of the following: “A B C” (full-size alphabet), “ABC” “CASE” (half-size capital alphabet) and “case” (half-size lowercase alphabet). Then, press and hold down the appropriate button, [2▲] - [7▲] and [2▼] - [5▼], for a while, or press it repeatedly until the desired number is selected.

NOTE

In the case of characters which are not accompanied by special character marks (with the exception of kana-kan and half-size katakana), you can call up the mark list by pressing the [6▼] button after selecting a character (before actual entry of a character).

Changing the Icon

You can also change the icon that appears at the left of the file name. Call up the **ICON SELECT** display by pressing the [1▼] (ICON) button from the character input display (page 45).

Select the desired icon by using the [A] - [J] buttons, or by using the [3▲▼] - [5▲▼] buttons, then enter the selected icon by pressing the [8▲] (OK) button.

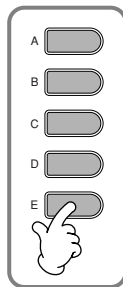

Turns pages for icon selection.

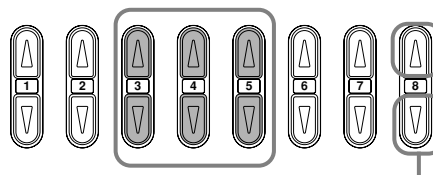
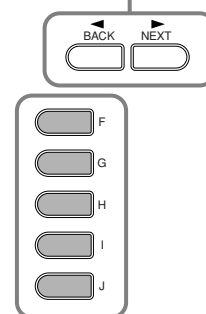

Enters the selected icon.

Cancels the icon selection operation.

Using the [DATA ENTRY] Dial

This convenient control lets you easily select items in the display or quickly change parameter values. The actual function of the [DATA ENTRY] dial differs depending on the selected display.

■ Adjusting values

You can change parameter values by rotating the [DATA ENTRY] dial. In the example [BALANCE] display, turning the dial adjusts the volume of the part in reverse display (highlight). To adjust the volume of another part, first select the part by pressing the [▲▼] button corresponding to the part, then rotate the [DATA ENTRY] dial.

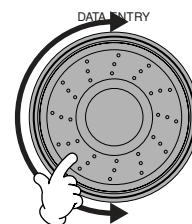
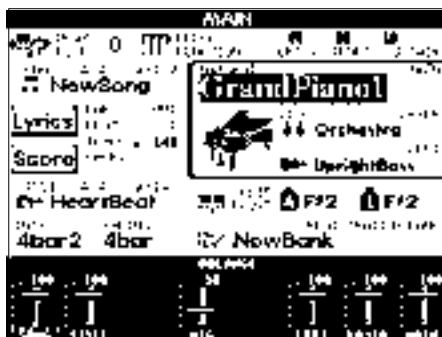

■ Selecting items

You can select the desired item or function in the display by rotating the [DATA ENTRY] dial. The selected item can then be called up or executed by using the [ENTER] button. In the example VOICE display, you can select the desired voice file with the [DATA ENTRY] dial, and call up the selected item by pressing the [ENTER] button on the panel.

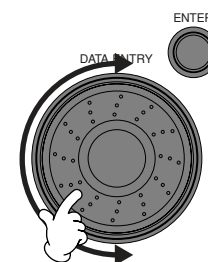

Direct Access — Instant Selection of Displays

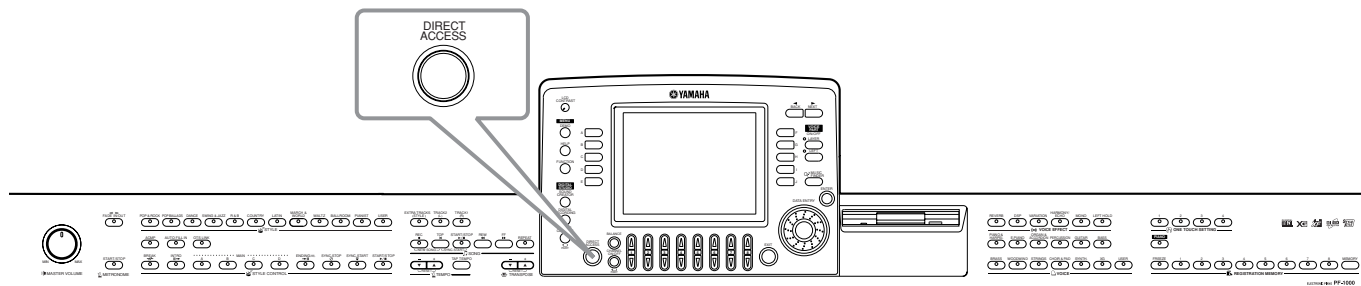

With the convenient Direct Access function, you can instantly call up the desired display — with just a single additional button press. Press the **[DIRECT ACCESS]** button and a message appears in the display prompting you to press the appropriate button. Then, simply press the button corresponding to the desired setting display to instantly call up that display. In the example below, Direct Access is used to call up the display for selecting the **Chord Fingering** (page 128).

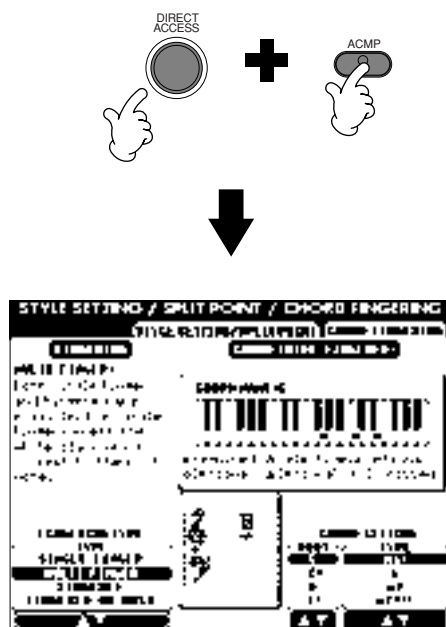

Refer to the Direct Access Chart (page 48) for a list of the displays that can be called up with the Direct Access function.

NOTE

Here's a convenient way to return to the **MAIN** display from any other display: Simply press the **[DIRECT ACCESS]** button, then the **[EXIT]** button.

Direct Access Chart

Operation: [DIRECT ACCESS] button + button listed below		Corresponding LCD display and function			See pages
STYLE	[POP & ROCK]	FUNCTION	STYLE SETTING/SPLIT POINT	SPLIT POINT (ACMP) setting	127
	[POP BALLADS]				
	[DANCE]				
	[SWING & JAZZ]				
	[R & B]				
	[COUNTRY]				
	[LATIN]				
	[MARCH & WORLD]				
	[WALTZ]				
	[BALLROOM]				
STYLE CONTROL	[ACMP]	FUNCTION	CHORD FINGERING	FINGERING TYPE selection	128
	[BREAK]	MIXING CONSOLE (STYLE PART)	VOLUME/VOICE	VOICE settings	117
	[INTRO]			PANPOT settings	
	MAIN [A]			VOLUME settings	
	MAIN [B]		HARMONIC CONTENT settings	118	
	MAIN [C]		BRIGHTNESS settings		
	MAIN [D]	REVERB settings	119		
	[ENDING]	CHORUS settings			
	[AUTO FILL IN]	DSP settings			
	[OTS LINK]	FUNCTION	STYLE SETTING/SPLIT POINT	SYNC. STOP WINDOW setting	127
[SYNC. STOP]					
[SYNC. START]					
[START/STOP]					
SONG	[TRACK1]	FUNCTION	SONG SETTING	TRACK1 CHANNEL selection	126
	[TRACK2]			TRACK2 CHANNEL selection	
	[EXTRA TRACKS]				
	[REPEAT]				
	[REC]				
	[TOP]				
	[START/STOP]				
	[REW]				
	[FF]				
	METRONOME			[START/STOP]	FUNCTION
[FADE IN/OUT]		FADE IN/OUT settings			
TEMPO	[TAP TEMPO]	TAP settings			
	[–]		MIDI	MIDI CLOCK setting	135
	[+]		CONTROLLER	TRANSPOSE settings	130
TRANSPOSE	[–]	MIXING CONSOLE	TUNE		118
	[+]				
MENU	[DEMO]	FUNCTION	UTILITY	LANGUAGE selection	140
	[HELP]			LCD BRIGHTNESS settings	138
	[FUNCTION]			MIDI settings	134
DIGITAL STUDIO	[SOUND CREATOR]	FUNCTION	MASTER TUNE/SCALE TUNE	MASTER TUNING setting	124
	[DIGITAL RECORDING]			SCALE TUNING setting	
	[MIXING CONSOLE]				
[BALANCE]		MIXING CONSOLE (SONG PART)	VOLUME/VOICE	VOLUME settings	117
[CHANNEL ON/OFF]				VOICE settings	
[DIRECT ACCESS]		Exit from the Direct Access mode			
[NEXT]					
[BACK]					
[ENTER]					
[MUSIC FINDER]		MUSIC FINDER	MUSIC FINDER SEARCH1 (Searching the records)		70
[EXIT]		Return to the MAIN display			
VOICE PART	[LAYER]	MIXING CONSOLE	TUNE	OCTAVE settings	118
	[LEFT]				
VOICE EFFECT	[REVERB]	MIXING CONSOLE	EFFECT	REVERB settings	119
	[DSP]			DSP settings	
	[VARIATION]			EFFECT TYPE selection	
	[HARMONY/ECHO]				
	[MONO]	FUNCTION	HARMONY/ECHO		132
	[LEFT HOLD]	MIXING CONSOLE	TUNE	PORTAMENTO TIME settings	118
VOICE	[PIANO & HARPSI]	FUNCTION	VOICE SET	SPLIT POINT (LEFT) setting	132
	[E.PIANO]				
	[ORGAN & ACCORDION]				
	[PERCUSSION]				
	[GUITAR]				
	[BASS]				
	[BRASS]				
	[WOODWIND]				
	[STRINGS]				
	[CHOIR & PAD]				
[SYNTH.]					
[XG]					
[USER]					
ONE TOUCH SETTING	[1]–[4]				
[PIANO]					
REGISTRATION MEMORY	[FREEZE]	FUNCTION	CONTROLLER	KEYBOARD TOUCH selection	130
	[1]–[8]	REGISTRATION BANK	FREEZE		131
	[MEMORY]		REGISTRATION EDIT (Editing the REGISTRATION)	83	
PEDAL	RIGHT	FUNCTION	CONTROLLER	REGISTRATION SEQUENCE (Creating the REGISTRATION SEQUENCE)	131
	CENTER			RIGHT PEDAL function assignment	
	LEFT			CENTER PEDAL function assignment	
				LEFT PEDAL function assignment	
	AUX			AUX PEDAL function assignment	

Help Messages

The Help messages give you explanations and descriptions of all the main functions and features of the PF-1000.

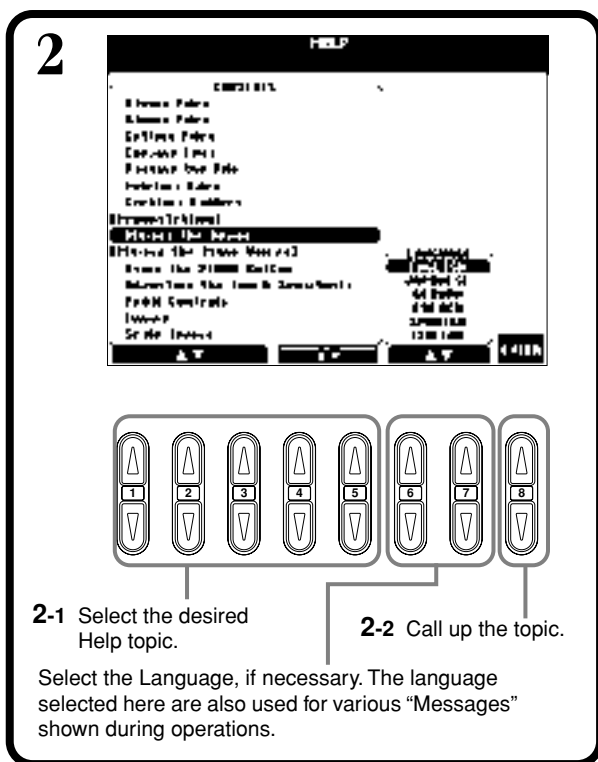
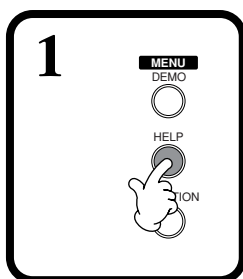
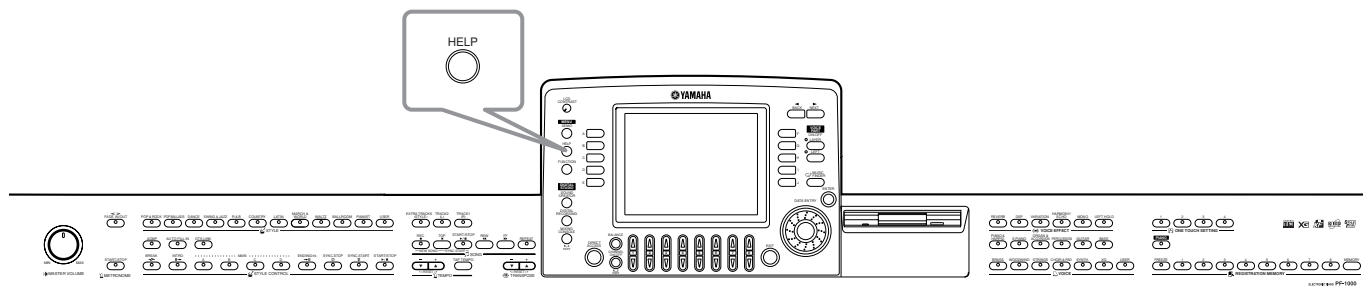

NOTE
Help messages can be displayed in any one of the following languages:

- ENGLISH
- JAPANESE
- GERMAN
- FRENCH
- SPANISH
- ITALIAN

NOTE
The language can also be selected in the FUNCTION "LANGUAGE" (page 140) display.

NOTE
When "JAPANESE" is selected for the Language parameter, and you change this to one of the western languages, the kanji and kana characters of the file name stored in the disk drive are changed to western characters. In the opposite case, special Latin characters and marks are changed into normal characters. Also, in the case of floppy disk data, text in the files are changed to characters that cannot be read by the instrument.

Keep in mind that similar problems may occur when trying to access files originating or edited by a computer having a different language operating system. In general, be careful when switching languages — you risk not being able to access the data properly.

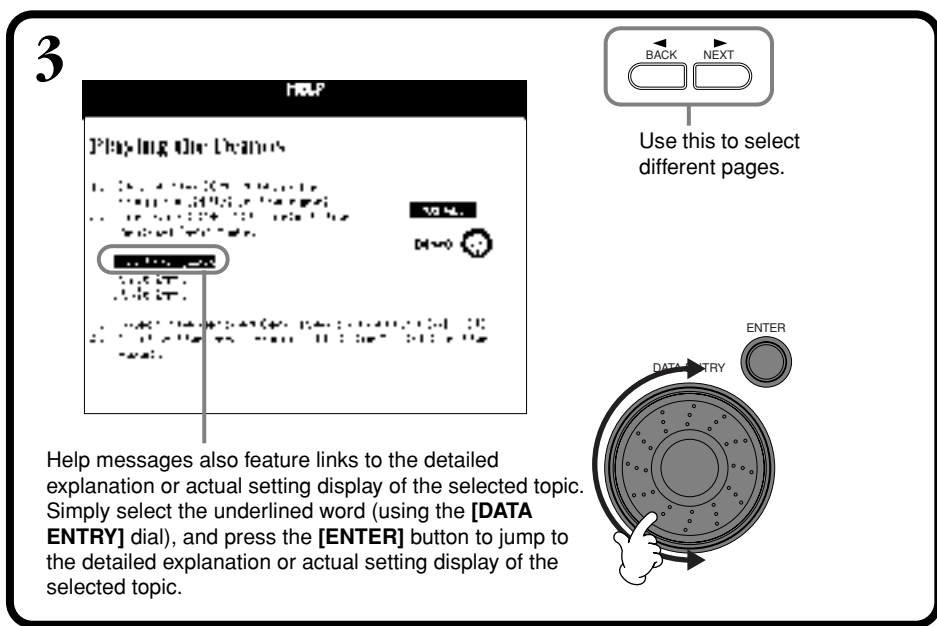

Using the Metronome

The **metronome** provides a click sound, giving you an accurate tempo guide when you practice, or letting you hear and check how a specific tempo sounds.

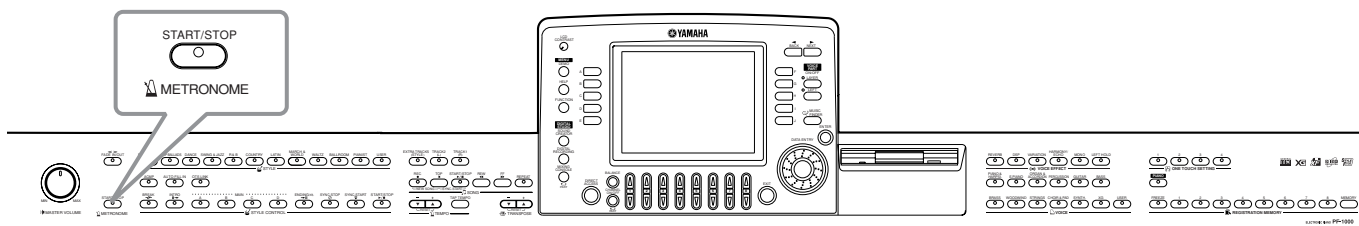

The **metronome** starts by pressing the METRONOME [START/STOP] button. Adjust the tempo by using the TEMPO[-] [+] buttons (see below). To stop the **metronome**, press the [START/STOP] button again.

NOTE

The sound, volume level, and the beat (time signature) of the metronome can all be changed (page 137).

Adjusting the Tempo

This section shows you to adjust the playback tempo — which not only affects the metronome, but also the playback of a song or an accompaniment style.

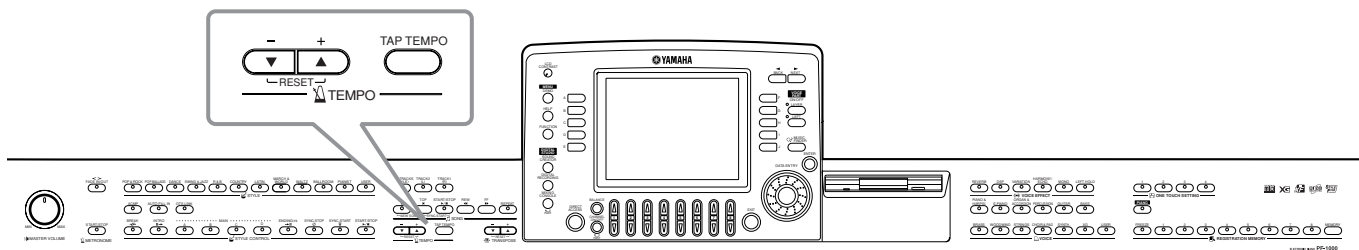

1

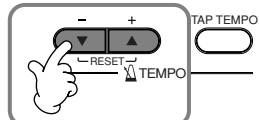

Press either the TEMPO [-] button or the [+] button.

2

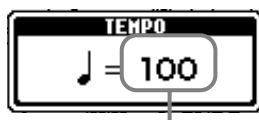

Adjust the tempo by using either the TEMPO [-] [+] buttons or the [DATA ENTRY] dial. The number in the display indicates how many quarter-note beats there are in one minute. The range is between 5 and 500. The higher the value, the faster the tempo.

When you change the tempo, both tempos of the current song and style will be changed to the same tempo. To restore their respective default (initial) tempo settings, press both the TEMPO [-] [+] buttons simultaneously. Also refer to the “Tempo Indications — MAIN display” (page 51) for more about tempo.

NOTE

Songs and accompaniment styles have been given default (initial) tempo settings, designed to best suit the song/style.



Press this to close the TEMPO display.



Tap Tempo

This useful feature lets you tap out the tempo for a song or an accompaniment style. Simply tap the **[TAP TEMPO]** button at the desired speed, and the tempo of the song or the accompaniment style changes to match your tapping.

1 Playback the song or the accompaniment style (page 59, 74).

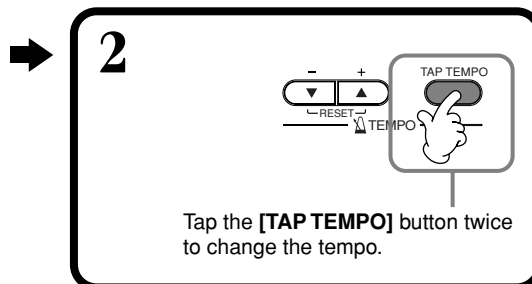

NOTE

Hitting the **[TAP TEMPO]** button produces a tapping sound. You can change this sound, if desired (page 138).

NOTE

You can also use Tap Tempo to automatically start the song or accompaniment style at the desired tempo. While both the song and accompaniment style are stopped, tap the **[TAP TEMPO]** button several times, and the selected accompaniment style starts automatically at the tempo you tapped. While a song is set to Sync. Start stand-by (page 60, 74), tapping the **[TAP TEMPO]** button starts the song playback in the same manner. For songs and styles in 2/4 and 4/4 time, tap four times; for 3/4 time, tap three times; for 5/4 time, tap five times.

Tempo Indications — MAIN Display

There are three different tempo indications in the Main display, as shown below.

Indicates the default (initial) tempo setting for the currently selected song (unless the tempo has been changed manually).

Indicates the current tempo for the selected song, accompaniment style or the metronome which is now playing back. When nothing is playing back (stopped), this indicates the tempo for the selected style. When the song and style are played back simultaneously, the tempo of the style is automatically changed to match the tempo of the song, and is displayed here. This tempo is used for recording when recording a song or accompaniment style.

Indicates the default (initial) tempo setting for the currently selected accompaniment style (unless the tempo has been changed manually).

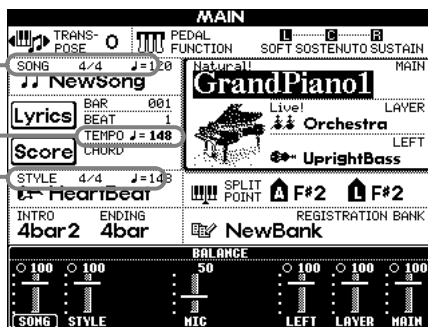

Playing the Demos

The PF-1000 is an extraordinarily versatile and sophisticated instrument, featuring a wide variety of dynamic voices and rhythms, plus a wealth of advanced functions. Three different types of Demo songs have been specially prepared showcasing the stunning sound and features of the PF-1000.

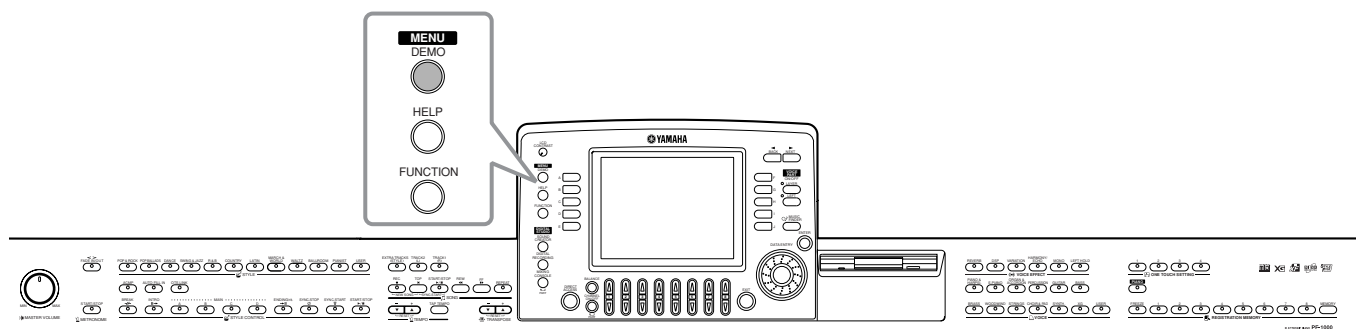

1 Pressing the [DEMO] button automatically plays back the Demo songs at random.



2

2-1 Use the [BACK][NEXT] buttons to select the desired Demo category.

Function Demos These demonstrate each of the different functions on the PF-1000.

Voice Demos These showcase the voices of the PF-1000.

Style Demos These introduce you to the rhythms and accompaniment styles of the PF-1000.

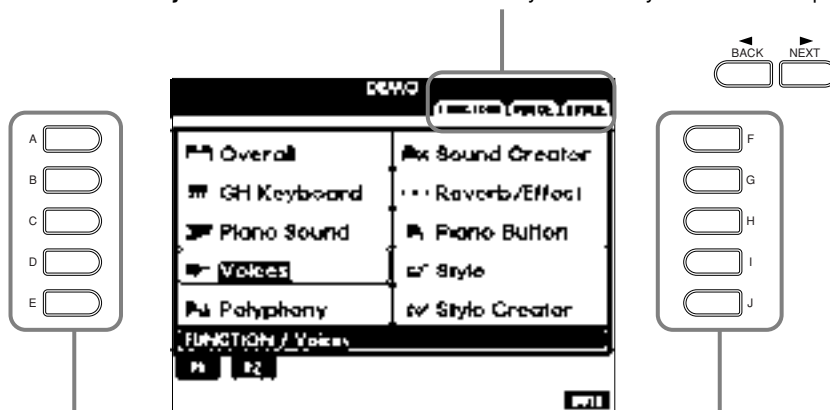

2-3 Press one of these buttons twice — once to select the desired demo, and once again to start it.

2-2 Use these to select different display pages.

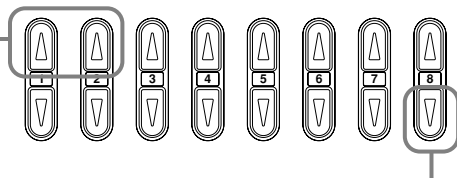

Press this to play back all Demo songs/items continuously, starting from the first item at the top left of the display. This is available only from the FUNCTION page.

All of the available demos are played back in sequence, starting from the one at top left. The VOICE and STYLE pages do not have the [AUTO] button; however, all demo songs are played back in sequence.

Pressing this button cancels the interactive features of the Function Demos (otherwise available in step 3 below).

3 For the Function demos, an introduction screen appears in the display and the Demo starts playing.

This example shows the Voices in the FUNCTION demo.

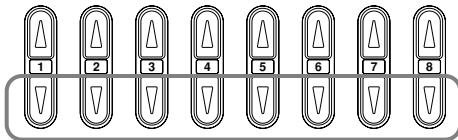
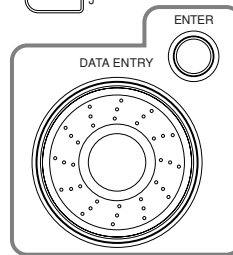

Select the desired word or item by using the [DATA ENTRY] dial, then press the [ENTER] button or number buttons ([1▼], [2▼], etc.) to call it up.

NOTE

Use the [BACK][NEXT] buttons in the introduction screen to call up the previous or next page.

NOTE

Press the SONG [START/STOP] button to stop the Demo song. To start the Demo again from the point at which it was stopped, press the SONG [START/STOP] button again. Rewind and fast-forward can also be used with the Demo songs (page 76).

4 Relevant explanations are shown in the display.

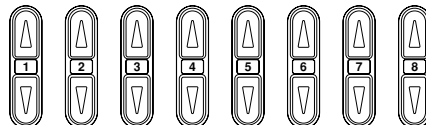

Return to the MAIN screen.

Voices

The PF-1000 gives you an enormous selection of authentic voices, including various keyboard instruments, strings and brass — and many, many more.

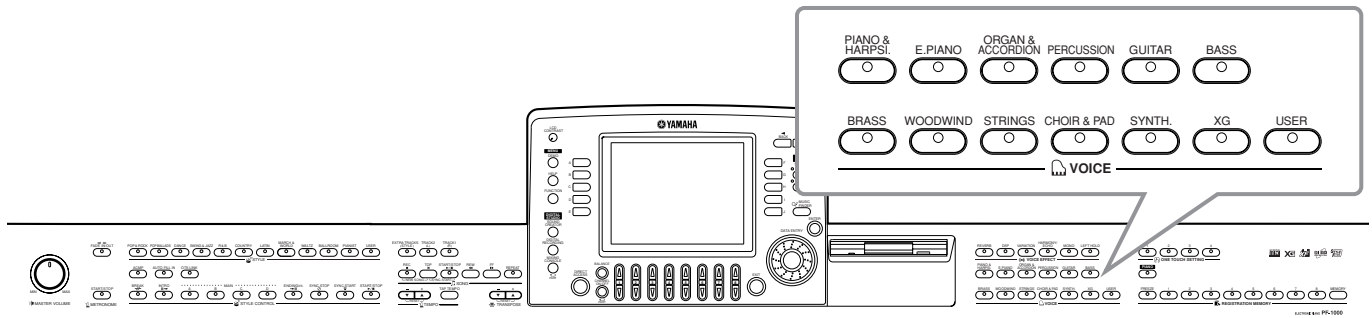

Selecting a Voice

1 Select the desired voice group.

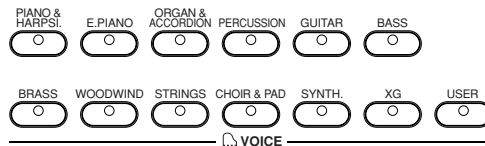

NOTE

When you select a voice group, the last selected voice will automatically be selected.

NOTE

Selecting a voice automatically selects the best-suited effect and other settings for that particular voice. You can disable this so that settings are not automatically selected (page 132).

NOTE

You can set how much the volume of the voice changes according to your playing strength (page 130).

NOTE

For a list of the available voices, refer to the separate Data List.

NOTE

You can set whether the voice bank and program change numbers ("MSB-LSB-Program Change number" at the right above the voice name) are displayed or not (page 138).

NOTE

XG is a major enhancement of the GM System level 1 format, and was developed by Yamaha specially to provide more voices and variations, as well as greater expressive control over voices and effects, and to ensure compatibility of data well into the future.

2 Indicates that the display is for selecting the MAIN voice (page 25).

2-1 Select the memory location of the voice (PRESET/USER/FLOPPY DISK).



2-3 Select the voice.

2-2 Select the various pages in the current voice group.

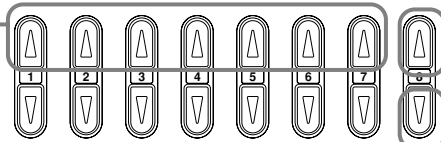

Press this to call up the display for selecting the voice group.

Press this to start the demo of the selected voice. To stop the demo at any time, press this button again.

3 Play the keyboard to hear the selected voice.

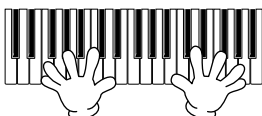

Press this to return to the MAIN display.



Voice Characteristics

The voice type and its defining characteristics are indicated above the voice name.

Natural!

These rich and luscious voices are comprised mostly of keyboard instrument sounds and are especially intended for playing piano and other keyboard parts. Since they use a completely independent sound source, you can play full, sustained chords — even along with the accompaniment style — and not have to worry about notes cutting off. They also take full advantage of Yamaha's advanced sampling technology such as Stereo Sampling, Dynamic Sampling, Sustain Sampling, and Key-off Sampling.

Live!

These acoustic instrument sounds were sampled in stereo, to produce a truly authentic, rich sound — full of atmosphere and ambience.

Cool!

These voices capture the dynamic textures and subtle nuances of electric instruments — thanks to a huge amount of memory and some very sophisticated programming.

Sweet!

These acoustic instrument sounds also benefit from Yamaha's sophisticated technology — and feature a sound so finely detailed and natural, you'll swear you're playing the real thing!

Drum

Various drum and percussion sounds are assigned to individual keys, letting you play the sounds from the keyboard.

SFX

Various special effect sounds are assigned to individual keys, letting you play the sounds from the keyboard.

Keyboard Percussion

When one of the drum or SFX kits is selected in the PERCUSSION voice group, various drum, percussion, and special effect sounds are assigned to individual keys, letting you play the sounds from the keyboard. The various drums and percussion instruments of the Standard Kit are indicated by symbols above the assigned keys. Keep in mind that even though different kits feature different sounds, some same-named sounds in different kits are identical.

Refer to the separate Data List (Drum/key Assignment List) for a listing of the sounds in each drum/SFX kit.

One-touch Piano Play

This convenient, easy-to-use feature completely and automatically reconfigures the entire PF-1000 for optimum piano performance. No matter what settings you've made from the panel, you can instantly call up the piano settings by a single button press.

**PIANO button**

This reconfigures all of the panel settings for playing the PF-1000 as a piano.

NOTE

You can also use the metronome with this function (page 50).

Piano Lock function

The convenient Piano Lock function lets you "lock" the piano so that you don't inadvertently change the settings by pressing another button on the panel. Once locked, the PF-1000 stays in the piano mode, even if other buttons are pressed — preventing you from accidentally starting a song or accompaniment style during a piano concert.

Hold down the [PIANO] button for a short time, until a message appears prompting you to enable Piano Lock.

To enable Piano Lock, select "OK."

To turn Piano Lock off, hold down the [PIANO] button again for a short time.

NOTE

Even if you turn Piano Lock off, the piano settings are still active.

Layer/Left — Playing Several Sounds Simultaneously

The PF-1000 lets you set three voices for simultaneous play: MAIN, LAYER, and LEFT. By effectively combining these three, you can create richly textured, multi-instrument setups for your performance.

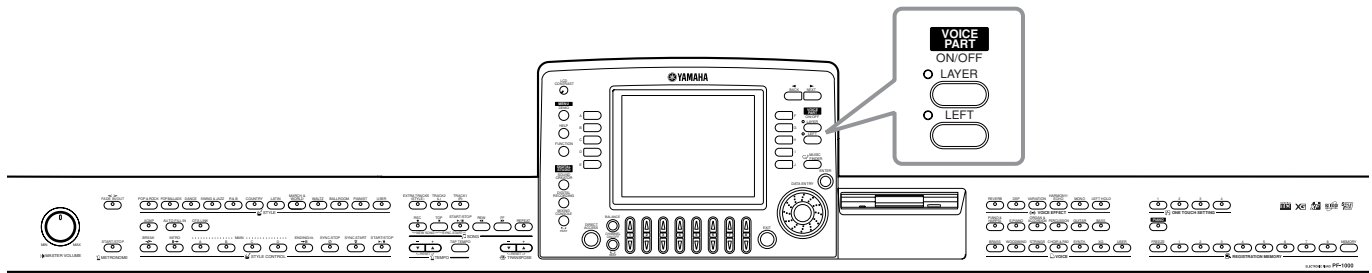

Playing a layer of two voices



Playing two voices separately — on the left and right sections of the keyboard

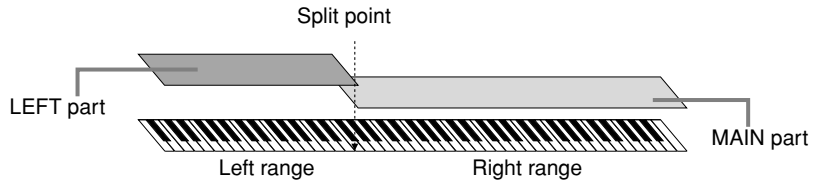

Playing three different voices — one on the left section of the keyboard, plus a layer of two on the right

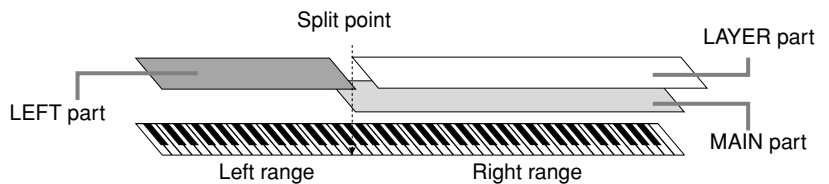

Layer — Layering Two Different Voices

1 Press this to turn the LAYER function on. To turn it off, press the button again.

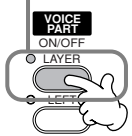

2 Select LAYER with the [G] button. Press the same button to call up the VOICE display, from which you can select the specific voice you want to play in a layer with the Main voice. The method of selecting a voice here is the same as that in VOICE (MAIN) display (page 54).

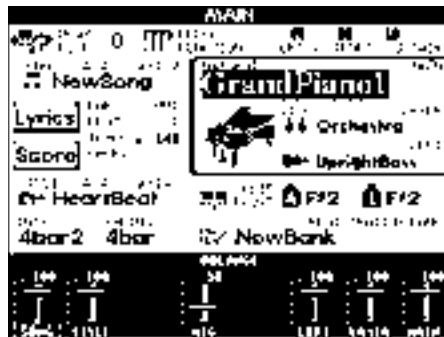

NOTE

There is an alternate way for quickly selecting both the MAIN and LAYER voices from the panel: While holding down one panel voice button, press a second voice button. The first selected voice becomes the MAIN voice, and the second becomes the LAYER.



Press this to return to the MAIN display.

Left — Setting Separate Voices for the Left and Right Sections of the Keyboard

1 Set the **LEFT** to **ON**. Press this button again to set it to **OFF**.

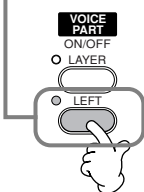

2 Select **LEFT** with the **[H]** button. Press the same button to call up the **VOICE** display, from which you can select the specific voice you want to play in a left. How to select the voice is the same as the way of **VOICE (MAIN)** screen (page 54).

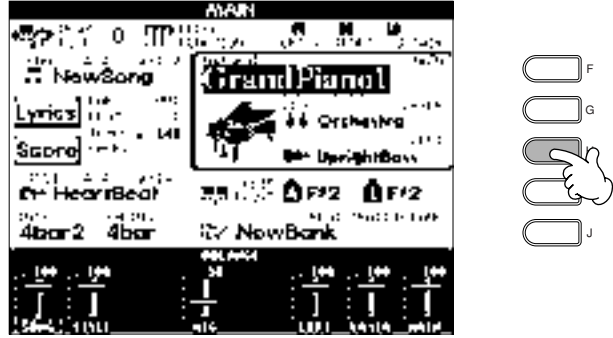

Press this to return to the **MAIN** display.

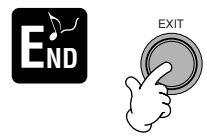

NOTE

The split point can be freely set to any key on the keyboard. To set it, call up the **SPLIT POINT** display by pressing the **[I]** (**SPLIT POINT**) button in the **MAIN** display. The operation steps are the same as in the **STYLE SETTING/SPLIT POINT** display of the **FUNCTION** page (page 127).

NOTE

Each part (**MAIN**, **LAYER**, and **LEFT**) can have its own volume setting (page 61).

NOTE

You can also use the **LAYER** and **LEFT** functions together, to create a combination layer/split. To do this, set separate voices for the left and right sections of the keyboard (as indicated), and set up a layer of two different voices on the right.

Applying Voice Effects

This section of the panel lets you add a variety of effects to the voices you play on the keyboard.

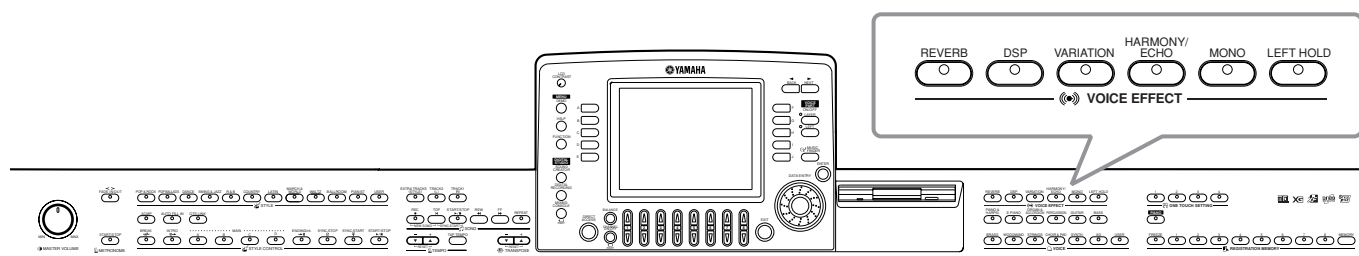

Press one of the effect buttons to turn the corresponding effects on. Press it again to turn the effect off. For explanations on each of the effects, see below.

■ REVERB

Reverb is an effect that recreates the acoustic ambiance of a performance space — anything from a small jazz club to a concert hall.

■ DSP

The PF-1000 features a variety of dynamic built-in digital effects, letting you process the sound in various ways. You can use DSP to enhance the voices in subtle ways — such as by applying chorus to add animation and depth, or using a symphonic effect to give the sound warmth and richness. DSP also has effects such as distortion that can completely change the character of the sound. DSP is set for the currently selected part (**MAIN**/**LAYER**/**LEFT**).

NOTE

The **DSP** and **VARIATION** effect types and their depth can be selected and adjusted in the **MIXING CONSOLE** display (page 119).

■ VARIATION (Regular voice only; page 86)

This control changes the Variation effect settings, letting you alter some aspect of the effect, depending on the selected type. For example, when the Rotary Speaker effect is selected (page 119), this lets you switch the rotor speed between slow and fast.

■ HARMONY/ECHO

This control adds Harmony or Echo effects to the voices played on the right hand section of the keyboard (page 132).

■ MONO

This control determines whether the voice is played monophonically (only one note at a time) or polyphonically for each part (MAIN/LAYER/LEFT). This is set to MONO when the lamp is lit, and set to polyphonic when the lamp is off. When set to MONO, only the last note played will sound. This lets you play wind instrument voices more realistically. Depending on the selected voice, the MONO setting also lets you effectively use the Portamento effect, when playing in legato.

■ LEFT HOLD

This function causes the left part voice to be held even when the keys are released — the same effect as when the damper (sustain) pedal is pressed. This function is especially effective when used with the auto accompaniment. For example, if you play and release a chord in the auto accompaniment section of the keyboard (with the left part on and the Left voice set to Strings), the strings part sustains, adding a natural richness to the overall accompaniment sound.

NOTE

The Portamento effect creates a smooth pitch glide between successively played notes.

HINT

You can add special emphasis to melody lines you play over chords by using the Layer function with a monophonic voice. Set the Main voice to play polyphonically and set the Layer voice to play monophonically (MONO). In this case, the melody you play — including the top notes of any chords — sounds monophonically. Try this using the following voices.

MAIN voice: Brass Section (polyphonic) + **LAYER voice:** Sweet Trump (monophonic)

Using the Pedals

Included with the PF-1000 is a special pedal unit that features the following pedals.

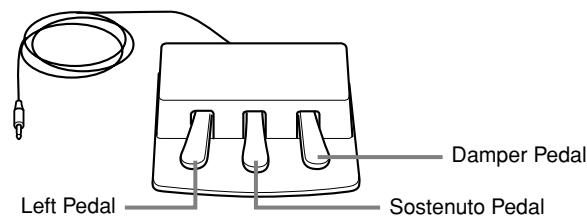

NOTE

You can also assign one of many other functions to these pedals (as well as the optional foot controller or footswitch). For example, you can use it to start/stop the accompaniment style, or use it to play Fill-ins (page 128).

■ Damper Pedal (Right)

The damper pedal performs the same function as the damper pedal on an actual acoustic piano, letting you sustain the sound of the voices even after releasing the keys.

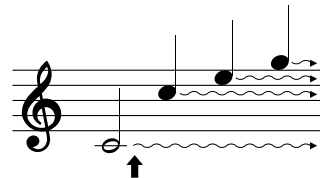

When you press the damper pedal here, the notes you play before you release the pedal have a longer sustain.

NOTE

- Some voices may sound continuously or have a long decay after the notes have been released while the damper pedal is held.
- Certain voices in the [PERCUSSION] and [XG] groups may not be affected by use of the damper pedal.

■ Sostenuto Pedal (Center)

If you play a note or chord on the keyboard and press the sostenuto pedal while the note(s) are held, those notes will be sustained as long as the pedal is held, but all subsequently played notes will not be sustained.

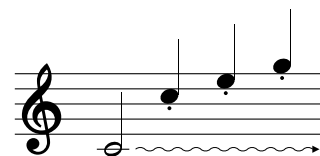

When you press the sostenuto pedal here while holding the note, the note will sustain as long as you hold the pedal.

NOTE

- Certain voices, such as [STRINGS] or [BRASS], sustain continuously when the sostenuto pedal is pressed.
- Certain voices in the [PERCUSSION] and [XG] groups may not be affected by use of the sostenuto pedal.

■ Left Pedal

When the Piano voice is selected, pressing this pedal reduces the volume and slightly changes the timbre of the notes you play. The settings assigned to this pedal may differ depending on the selected voice.

NOTE

The depth of the left pedal effect can be adjusted (page 128).

■ Foot Controller/Footswitch

An optional Yamaha foot controller (FC7) or footswitch (FC4 or FC5) can be connected to the AUX PEDAL jack and used to control various functions assigned in the FUNCTION page (page 128).

Styles

The PF-1000 features styles (accompaniment patterns) in a variety of different musical genres including pops, jazz, Latin and dance. To use it, all you have to do is play the chords with your left hand as you perform and the selected Accompaniment Style (style) matching your music will automatically play along, instantly following the chords you play. Try selecting some of the different styles (refer to separate Data List (Style List)) and play them.

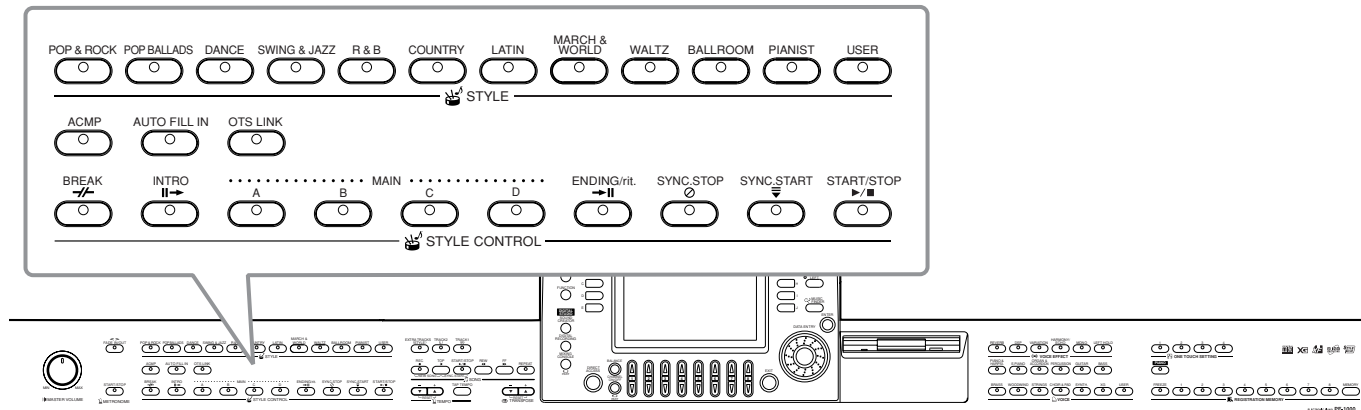

Playing a style

1

2

2-1 Select a location (Preset, User, Floppy Disk) for saving the style.

2-2 Select a Style.

When you've opened a lower directory's display, this button (UP) lets you call up the next higher directory, from which you can select Style groups.

NOTE
For a list of the available accompaniment styles, refer to the separate Data List (Style List).

3

When the [ACMP] button is set to on, you can play/indicate chords from the auto accompaniment section of the keyboard. (Depending on the settings, this may be the range of the Left voice, or the entire keyboard.)

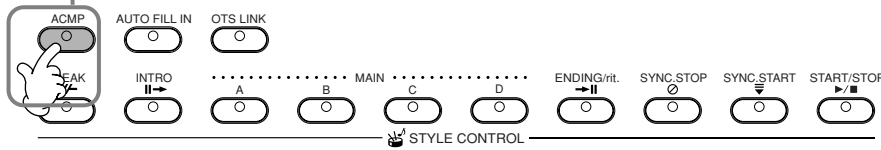

NOTE

You can set the key range for auto accompaniment (page 127).

4

Turn SYNC. (SYNCHRONIZED) START on.

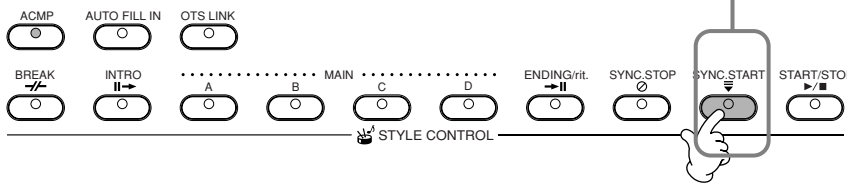

NOTE

Sync. Start

Enabling this lets you start the style simply by playing the keyboard.

5

As soon as you play a chord with the auto accompaniment section, the style starts. For details about chord fingerings, refer to page 62.

The Tempo can be adjusted using the TEMPO [-][+] or [TAP TEMPO] button. If you tap the [TAP TEMPO] button, the tempo will adjust to the same speed that you tapped.

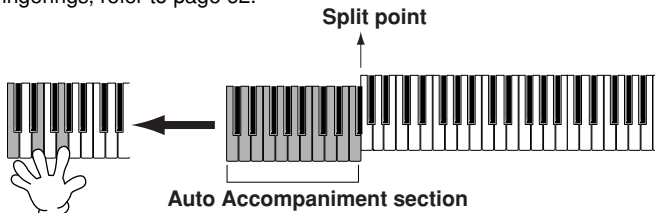

NOTE

- You can begin the rhythm channels (tracks) of the Style by pressing the [START/STOP] button.
- The rhythm channels of the style can also be started by tapping the [TAP TEMPO] button. With the style stopped, tap the [TAP TEMPO] button three, four or five times (three for 3/4 time, four for 2/4 or 4/4 time, five for 5/4 time).

6

Stop the style.

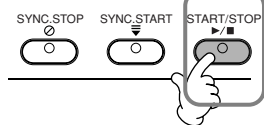

Turn ACMP off.

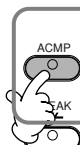

NOTE

When you simultaneously play back accompaniment styles with a song, the accompaniment parts recorded to the song (channels 9 - 16) are temporarily replaced by the selected accompaniment style — letting you try out and use different accompaniment with the song (page 75).

Accompaniment Style Characteristics

The defining characteristics of some of the accompaniment styles are indicated above the relevant style names in the Open/Save display.

Session!

These styles provide even greater realism and authentic backing by mixing in original chord types and changes, as well as special riffs with chord changes, with the Main sections. These have been programmed to add “spice” and a professional touch to your performances of certain songs and in certain genres. As a result, the styles may not necessarily be appropriate — or even harmonically correct — for all songs and for all chord playing. In some cases for example, playing a simple major triad may result in a seventh chord, or playing an on-bass chord may result in incorrect or unexpected accompaniment.

Piano Combo!

These accompaniment styles feature a basic piano trio (piano, bass, and drums), augmented in some cases with other instruments. Since this is a small combo sound, the accompaniment backing is appropriately sparse, making it useful and effective for a wide variety of songs.

Pianist!

These special styles provide piano-only accompaniment — effectively recreating the left-hand performance of an accomplished pianist. Just by playing the proper chords with your left hand, you can automatically add complicated arpeggios and bass/chord patterns — such as difficult-to-play stride piano parts.

Playing a Style's Rhythm Channels only

1 Select a style (page 59).

NOTE
The Rhythm channels are part of the styles. Each style has different rhythm patterns.

2 **Set to off.** **Rhythm starts.**

NOTE
You can also start the rhythm simply by playing a key on the keyboard, if Sync Start is enabled (turn on the [SYNC.START] button).

3 **Play along with the rhythm playback.**
The Tempo can be adjusted using the **TEMPO [-][+]** or **[TAP TEMPO]** buttons. If you tap the **[TAP TEMPO]** button, the tempo will adjust to the same speed that you tapped.

NOTE
When selecting the style group "**PIANIST**," the rhythm doesn't sound. When you want to use any of the styles, always make sure that **ACMP** is turned on.

END Press the **STYLE CONTROL [START/STOP]** button again to stop the rhythm playback.

Adjusting the Volume Balance/Channel Muting

BALANCE display

Call up the **BALANCE** display.

Adjust the output level of the Part.

CHANNEL ON/OFF display

Call up the **CHANNEL ON/OFF** display.

Call up the **STYLE** display by pressing the **[CHANNEL ON/OFF]** button, then turn the instrument you want to cancel off. To listen to only one instrument by itself, hold down the appropriate button for the channel to set the channel to **SOLO**. To cancel **SOLO**, simply press the appropriate channel button again.

NOTE
Channel
Refers to the MIDI channel in the song data (page 147). The channels are assigned as shown below.
Song
1 - 16
Accompaniment Style
9 - 16

Chord Fingerings

The style playback can be controlled by the chords you play in the keys to the left of the split point. There are 7 types of fingerings as described below. Go to the CHORD FINGERING page (page 128), and select the Chord Fingerings. The page shows how to play chords with your left hand.

SINGLE FINGER

Single Finger accompaniment makes it simple to produce beautifully orchestrated accompaniment using major, seventh, minor and minor-seventh chords by pressing a minimum number of keys on the auto accompaniment section of the keyboard. The abbreviated chord fingerings described below are used.

For a major chord, press the root key only.

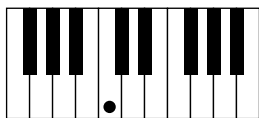

For a minor chord, simultaneously press the root key and a black key to its left.

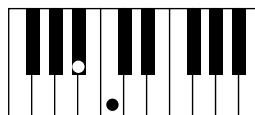

For a seventh chord, simultaneously press the root key and a white key to its left.

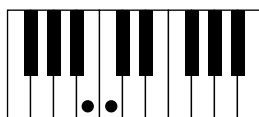

For a minor-seventh chord, simultaneously press the root key and both a white and black key to its left.

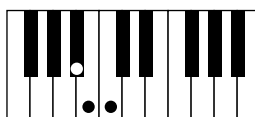

MULTI FINGER

The Multi Finger mode automatically detects Single Finger or Fingered chord fingerings, so you can use either type of fingering without having to switch fingering modes. If you want to play minor, seventh, or minor-seventh chords using the SINGLE FINGER operation in the MULTI FINGER Mode, always press the closest white/black key(s) to the root of the chord.

FINGERED

This mode lets you produce accompaniment by playing full chords on the auto accompaniment section of the keyboard. The Fingered mode recognizes the various chord types listed on the next page.

FINGERED ON BASS

This mode accepts the same fingerings as the FINGERED mode, but the lowest note played in the auto accompaniment section of the keyboard is used as the bass note, allowing you to play “on bass” chords. For example, to indicate a C-on-E chord, play a C major chord with E as the lowest note (E, G, C).

FULL KEYBOARD

This method detects chords in the entire key range. Chords are detected in a way similar to Fingered, even if you split the notes between your left and right hands — for example, playing a bass note with your left hand and a chord with your right, or by playing a chord with your left hand and a melody note with your right.

AI FINGERED

This mode is basically the same as FINGERED, with the exception that less than three notes can be played to indicate the chords (based on the previously played chord, etc.).

AI FULL KEYBOARD

When this advanced auto accompaniment mode is engaged, the PF-1000 will automatically create appropriate accompaniment while you play just about anything, anywhere on the keyboard using both hands. You don't have to worry about specifying the accompaniment chords. Although the AI Full Keyboard mode is designed to work with many songs, some arrangements may not be suitable for use with this feature.

This mode is similar to FULL KEYBOARD, with the exception that less than three notes can be played to indicate the chords (based on the previously played chord, etc.). 9th and 11th chords cannot be played.

NOTE

Chord detection in the AI Full Keyboard mode occurs at approximately 8th-note intervals. Extremely short chords — less than an 8th note in length — may not be detected.

NOTE

In Full Keyboard mode, chords are detected based on the lowest and second lowest notes you play. If the two lowest notes fall within a single octave, those two notes determine the chord. If the lowest note and the second lowest note are separated by more than one octave, the lowest note becomes the bass and the chord is determined from the second lowest note and the other notes played in the same octave.

NOTE

AI
Artificial Intelligence

Chord Types Recognized in the Fingered Mode (Example for “C” chords)

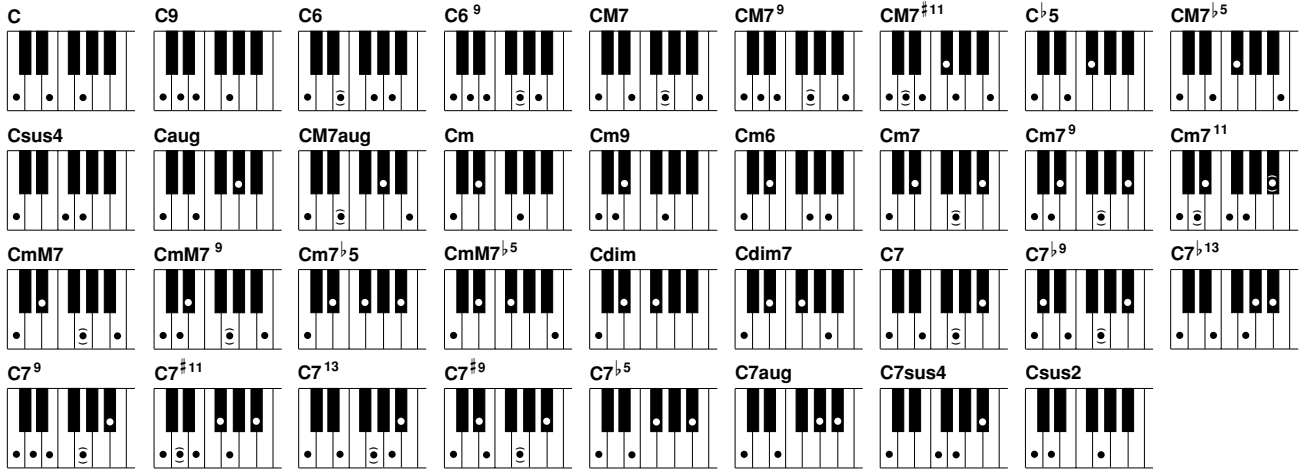

Chord Name [Abbreviation]	Normal Voicing	Display for root “C”
Major [M]	1 - 3 - 5	C
Ninth [9]	1 - 2 - 3 - 5	C9
Sixth [6]	1 - (3) - 5 - 6	C6
Sixth ninth [6 ⁹]	1 - 2 - 3 - (5) - 6 or 3 - 6 - 2*	C6 ⁹
Major seventh [M7]	1 - 3 - (5) - 7	CM7
Major seventh ninth [M7 ⁹]	1 - 2 - 3 - (5)j - 7	CM7 ⁹
Major seventh add sharp eleventh [M7 ^{#11}]	1 - (2) - 3 - #4 - 5 - 7 or 1 - 2 - 3 - #4 - (5) - 7	CM7 ^{#11}
Flatted fifth [^b5]	1 - 3 - ^b5	C^b5
Major seventh flatted fifth [M7 ^{b5}]	1 - 3 - ^b5 - 7	CM7 ^{b5}
Suspended fourth [sus4]	1 - 4 - 5	Csus4
Augmented [aug]	1 - 3 - #5	Caug
Major seventh augmented [M7aug]	1 - (3) - #5 - 7	CM7aug
Minor [m]	1 - ^b3 - 5	Cm
Minor ninth [m9]	1 - 2 - ^b3 - 5	Cm9
Minor sixth [m6]	1 - ^b3 - 5 - 6	Cm6
Minor seventh [m7]	1 - ^b3 - (5) - ^b7	Cm7
Minor seventh ninth [m7 ⁹]	1 - 2 - ^b3 - (5) - ^b7 or ^b3 - ^b7 - 2	Cm7 ⁹
Minor seventh eleventh [m7 ¹¹]	1 - (2) - ^b3 - 4 - 5 - (^b7)	Cm7 ¹¹
Minor major seventh [mM7]	1 - ^b3 - (5) - 7	CmM7
Minor major seventh ninth [mM7 ⁹]	1 - 2 - ^b3 - (5) - 7	CmM7 ⁹
Minor seventh flatted fifth [m7 ^{b5}]	1 - ^b3 - ^b5 - ^b7	Cm7 ^{b5}
Minor major seventh flatted fifth [mM7 ^{b5}]	1 - ^b3 - ^b5 - 7	CmM7 ^{b5}
Diminished [dim]	1 - ^b3 - ^b5	Cdim
Diminished seventh [dim7]	1 - ^b3 - ^b5 - 6	Cdim7
Seventh [7]	1 - 3 - (5) - ^b7 or 1 - (3) - 5 - ^b7	C7
Seventh flatted ninth [7 ^{b9}]	1 - ^b2 - 3 - (5) - ^b7	C7 ^{b9}
Seventh add flatted thirteenth [7 ^{b13}]	1 - 3 - 5 - ^b6 - ^b7	C7 ^{b13}
Seventh ninth [7 ⁹]	1 - 2 - 3 - (5) - ^b7 or 3 - ^b7 - 2*	C7 ⁹
Seventh add sharp eleventh [7 ^{#11}]	1 - (2) - 3 - #4 - 5 - ^b7 or 1 - 2 - 3 - #4 - (5) - ^b7	C7 ^{#11}
Seventh add thirteenth [7 ¹³]	1 - 3 - (5) - 6 - ^b7 or 3 - 6 - ^b7	C7 ¹³
Seventh sharp ninth [7 ^{#9}]	1 - #2 - 3 - (5) - ^b7	C7 ^{#9}
Seventh flatted fifth [7 ^{b5}]	1 - 3 - ^b5 - ^b7	C7 ^{b5}
Seventh augmented [7aug]	1 - 3 - #5 - ^b7	C7aug
Seventh suspended fourth [7sus4]	1 - 4 - 5 - ^b7	C7sus4
Suspended second [sus2]	1 - 2 - 5	Csus2

NOTE

- Notes in parentheses can be omitted.
- For FINGERED, FIN-GERED ON BASS, and AI FINGERED, if you play any three adjacent keys (including black keys), the chord sound will be canceled and only the rhythm instruments will continue playing (Chord Cancel function). This let you play back only the rhythm.
- Playing two same root keys in the adjacent octaves produces accompaniment based only on the root.
- A perfect fifth (1 + 5) produces accompaniment based on the root and the fifth.
- The auto accompaniment Style will sometimes not change when related chords are played in sequence (e.g. some minor chords followed by the minor seventh).
- You can also have the PF-1000 “teach” you how to play Fingered chords. From the CHORD FINGERING display (page 128), specify the chord you want to learn, and the notes you should press are indicated in the display.

* Only this voicing (inversion) is recognized. Other chords not marked with an asterisk can be played in any inversion.

Arranging the Style Pattern (SECTIONS: MAIN A/B/C/D, INTRO, ENDING, BREAK)

The PF-1000 features various types of Auto Accompaniment Sections that allow you to vary the arrangement of the Style. They are: Intro, Main, Break and Ending. By switching among them as you play, you can easily produce the dynamic elements of a professional-sounding arrangement in your performance.

NOTE

You can also use this function to play only rhythms (page 61).

NOTE

- If you press the **[INTRO]** button, you can play back an Intro section while an accompaniment is playing.
- Section button indications — **[BREAK]**, **[INTRO]**, **[MAIN]**, **[ENDING]** buttons
 LED is green — The section is not selected.
 LED is red — The section is currently selected.
 LED is off — No section data; the section cannot be played.
- You can dynamically control the level of the accompaniment by how softly or strongly you play the keys in the Auto Accompaniment section of the keyboard (page 127).
- If you press the **[SYNC. START]** button while an accompaniment is playing, the accompaniment will stop and the PF-1000 will enter Synchronized Start standby status.
- You can also change style sections by using the pedal (page 128).
- The Break section lets you add dynamic variations and breaks in the rhythm of the accompaniment, to make your performance sound even more professional. If you press the **[BREAK]** button while an accompaniment is playing, the fill-in will play back for one measure.
- The indicator of the destination section (MAIN A/B/C/D) will flash while the Break is playing.
- When the **[AUTO FILLIN]** button is set to on and the **MAIN [A][B][C][D]** button is pressed after the final half beat (eighth note) of the measure, the fill-in will begin from the next measure.

1 Select a style (page 59).



2 2-1 Turn the ACMP function on.

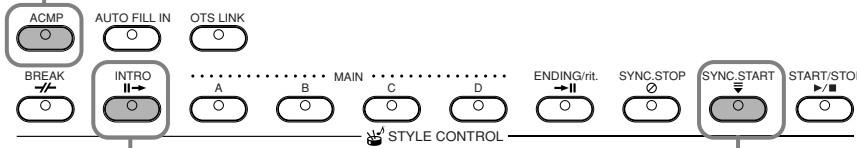

2-3 Turn the SYNC. START function on.

2-2 Press the **[INTRO]** button. To cancel the INTRO section before starting the style, press the **[INTRO]** button again.



3 The Intro section starts as soon as you play a key in the Auto Accompaniment section of the keyboard, and changes to the Main section.

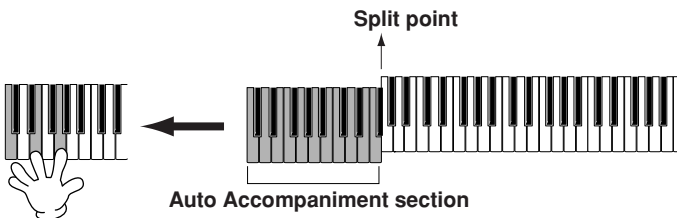

4

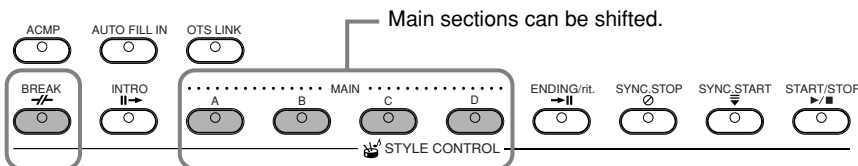

Press this button to add breaks.





This switches to the ending section. When the ending is finished, the Style stops automatically. You can have the ending gradually slow down (ritardando) by pressing the same [ENDING/rit.] button again while the ending is playing back.

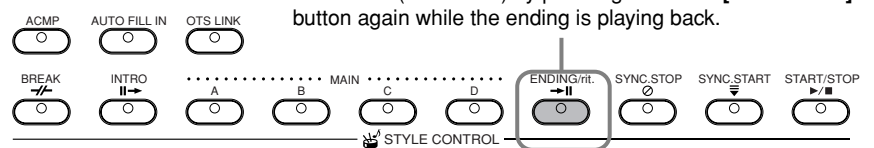

Fade-in/Fade-out
 The accompaniment style also include a convenient Fade-in/Fade-out function that gradually fades in and fades out the accompaniment. To start the style with a fade-in, press the [FADE IN/OUT] button, then turn SYNC. START on. To cancel the fade-in before starting the style, press the button again.
 To fade out and stop the Style, press this button while the style is playing. The time of the fade-in/fade-out can also be set (page 137).

Stopping the Style Playback While Releasing Keys (SYNC. STOP)

When the Synchro Stop function is engaged, accompaniment playback will stop completely when all keys in the Auto Accompaniment section of the keyboard are released. Accompaniment playback will start again as soon as the key in the Auto Accompaniment section is played.

- 1 Turn ACMP (Accompaniment) on.**

↓

- 2 Turn SYNC. STOP on.** SYNC. START is also automatically set to on when SYNC. STOP is turned on.

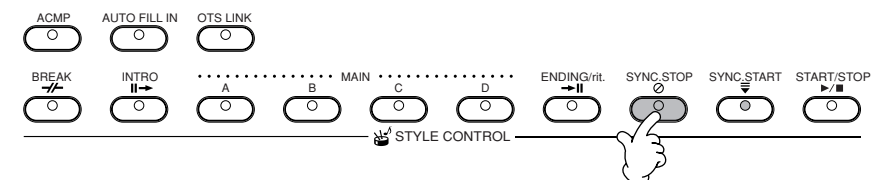

↓

- 3 As soon as you play a chord with your left hand, the auto accompaniment starts.**

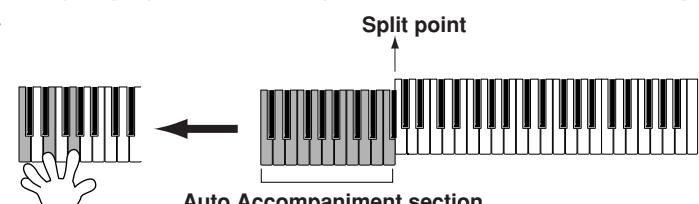

↓

- 4 The auto accompaniment stops when you release your left hand from the keys.**

↓

5 Playing a chord with your left hand automatically restarts the auto accompaniment.

→



Press the [SYNC. STOP]/[SYNC. START] button again to stop the accompaniment.

- NOTE**
- Styles can also be started by pressing the **STYLE CONTROL [START/STOP]** button.
 - You can select the Intro and Ending type by pressing the **[E]** button in the **MAIN** window in the **MAIN** window (page 66).
 - If you press the **[INTRO]** button while the ending is playing, the Intro section will begin playing after the ending is finished.
 - When the **[AUTO FILLIN]** button is set to on and you press a **MAIN** button while the ending is playing, fill-in accompaniment will immediately start playing, continuing with the Main section.
 - You can begin the accompaniment by using the Ending instead of the Intro section. In this case, the auto accompaniment doesn't stop when the ending is finished.
 - If you select a different style while the style is not playing, the "default" tempo for that style is also selected. If the accompaniment is playing, the same tempo is maintained even if you select a different style.
 - When **STOP ACMP** is set to on and the accompaniment is not playing, you can play both chords and bass in the Auto Accompaniment section in the keyboard (page 127).

NOTE
 You can also use the SYNC. STOP function by pressing the auto accompaniment section/left-hand range briefly (page 127).

NOTE
 Synchro Stop cannot be set to on when the fingering mode is set to Full Keyboard/All Keyboard or the auto accompaniment on the panel is set to off.

Selecting Intro and Ending Types (INTRO/ENDING)

1

NOTE
To call up the [MAIN] display, first press the [DIRECT ACCESS] button, then press the [EXIT] button.

2

3 Play the style using the Intro or Ending section (page 30, 31).

Playing Fill-in patterns automatically when changing accompaniment sections — Auto Fill In

NOTE
Fill
A short phrase used to add variation to the style.

1

2 Play the style and switch among the accompaniment sections as they play (page 30, 31).
Fill-in patterns play automatically between each change in the Main sections.

NOTE
You can also add a fill-in by pressing the selected MAIN button again.

END To cancel the Auto Fill, press the [AUTO FILLIN] button again.

NOTE
You can temporarily disable Auto Fill In during a performance by pressing the next Main section's button twice quickly.

Appropriate Panel Setting for the Selected Style (ONE TOUCH SETTING)

The convenient One Touch Setting function makes it easy for you to select voices and effects that are appropriate to the style you're playing. Each preset style has four pre-programmed panel setups that you can select by pressing a single button.

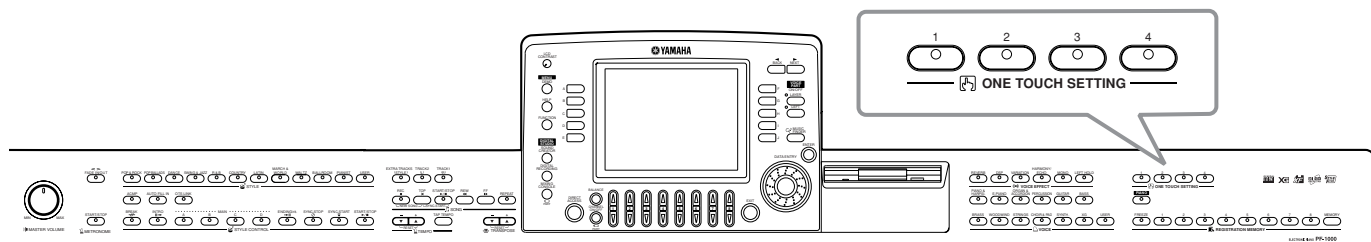

1 Select a style (page 59).

2 Press one of the ONE TOUCH SETTING buttons ([1] - [4]).

LED is red — The One Touch Setting is currently selected.

LED is green — The One Touch Setting is not selected.

LED is off — No One Touch Setting data. The button is not available.

Various settings (such as voices, effects, etc.) that match the selected style can be instantly recalled. When the style is not playing, Auto Accompaniment and Sync. Start will automatically be turned on. For details about the One Touch Setting parameters, refer to the separate Data List (Parameter Chart).

3 As soon as you play a chord with your left hand, the auto accompaniment starts.

Split point

Auto Accompaniment section

4 Stop the Auto Accompaniment.

ACMP AUTO FILL IN OTS LINK

BREAK INTRO MAIN ENDING/rit. SYNC_STOP SYNC_START START/STOP

STYLE CONTROL

5 Try out other One Touch Setting setups. You can also create your own One Touch Setting setups (page 68).

Automatically Changing One Touch Settings with the Sections — OTS Link

The convenient OTS (One Touch Setting) Link function lets you automatically have One Touch Settings change when you select a different Main section (A - D).

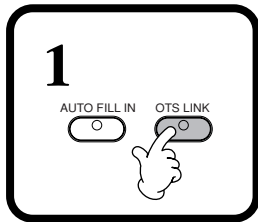

2 When you switch among the Main sections (A - D), the corresponding One Touch Setting will be called up automatically.
The Main sections A, B, C, and D correspond to One Touch Settings 1, 2, 3, and 4, respectively.

NOTE
The One Touch Settings can be set to change with the sections in one of two different timings (page 127):

- Immediately when you press a section button.
- At the next measure (in an accompaniment style), after you press a section button.

END To cancel the OTS Link function, press the [OTS LINK] button again.

Registering the Panel Controls in One Touch Setting (ONE TOUCH SETTING)

This section covers how to create your own One Touch Setting setups (four setups per style). For a list of One Touch Setting setup parameters, refer to the separate Data List (Parameter Chart).

1 Select a style.

2 Set up the panel controls such as selecting a voice as required.

3 Press the [MEMORY] button.

4 Press one of the ONE TOUCH SETTING buttons:[1] through [4].

The items you can register in a One Touch Setting are Voice, Harmony and Pedal settings.

END A message prompting you to save the current style will appear. Select “YES” to call up the STYLE display, then save the panel settings (page 38, 44).

NOTE
Unless you store the panel settings here, the registered settings will be deleted when you select a different accompaniment style.

Calling Up Ideal Setups for Your Music — Music Finder

The Music Finder feature lets you instantly call up the appropriate settings for the instrument — including voice, style, and One Touch Settings — simply by selecting the desired song title. If you want to play a certain song but don't know which style and voice settings would be appropriate, the convenient Music Finder function will help you out. The recommended settings, which together make up a “record,” can also be edited and stored. This lets you create and save your own Music Finder records for future recall.

NOTE
The MUSIC FINDER records and its contents is just one example of the recommended panel setups. You can also create your own Music Finder settings for your favorite songs and genres.

NOTE
Keep in mind that Music Finder is a performance aid in that it automatically finds appropriate accompaniment styles and voices for your playing. Even though you can specify song titles, it does not actually contain song data.

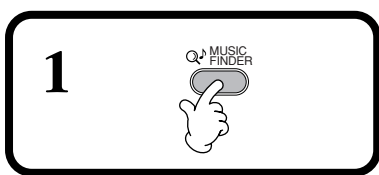
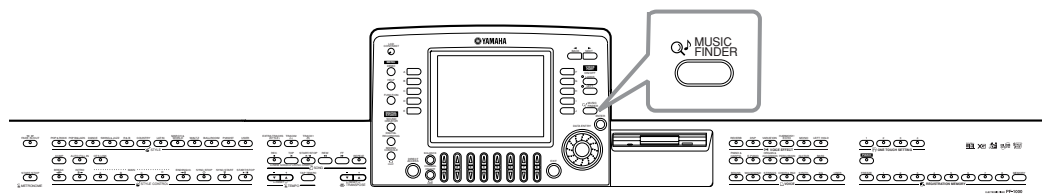

2 **Select a record.** For example, select the top record by pressing the [1▲▼] button to call up the recommended setups. The setting data shown here is referred to as a “record.”

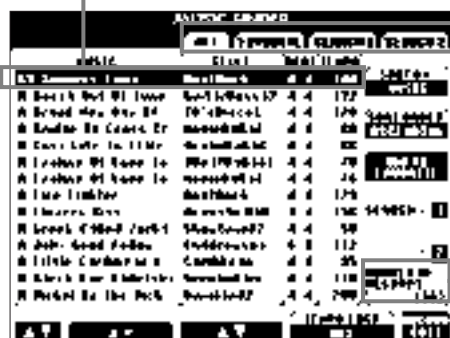

- All Show all records.
- FAVORITE..... Show the records that have added to the “Favorite” page.
- SEARCH1,2..... Show the results by SEARCH function (page 70).

Sorting the records

- MUSIC The record is sorted by song title.
- STYLE..... The record is sorted by style name.
- BEAT The record is sorted by beat.
- TEMPO The record is sorted by tempo.

Change the order of the records (ascending or descending).

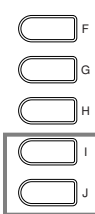

Add the selected record to “Favorite (Bookmark)” page
When you press the [H] button, the “Add selected data to the favorite list? YES/NO” message will be displayed. Select [YES] to add the selected page to “FAVORITE” page.

Search record(s). Enter the condition of the search in the MUSIC FINDER SEARCH display (page 70). The results of SEARCH 1 or 2 appear in the “SEARCH 1” or “SEARCH 2” page respectively.

Show the number of records of each page.

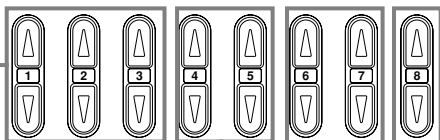

Call up the MUSIC FINDER RECORD EDIT (page 71) display (for editing the selected record).

Select a record by song title.
When sorting records by song title, use the [1▲▼] button to skip up or down through the songs alphabetically. Simultaneously press the [▲▼] buttons to move the cursor to the first record.

Turn TEMPO LOCK on/off. TEMPO LOCK function lets you avoid changing the Tempo during style playback when selecting another record. The on/off setting affects all pages (ALL/FAVORITE/SEARCH 1/SEARCH 2).

Select a record by style name. When sorting the records by style name, press these buttons to move the cursor to the next /previous style. Simultaneously press the [▲▼] buttons to move the cursor to the first record.

3 Play the style (page 60).

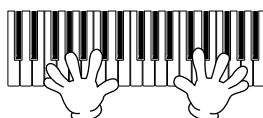

NOTE
Records can be selected by using the [DATA ENTRY] dial and pressing the [ENTER] button.

Searching the Ideal Setups — Music Finder Search

You can search the record by music title or keywords. The results appears in the display.

1 Press the [I] (SEARCH 1) button or [J] (SEARCH 2) button in the MUSIC FINDER display.

2 Enter the conditions for the search (see below), then start search by using [START SEARCH] button.

F

G

H

I

J

Start searching the record. The results that satisfy all the conditions appear in the **SEARCH** page. For details about the search settings in this display, see below.

1 2 3 4 5 6 7 8

■ [A] MUSIC

Searches by music or song title. Press this button to call up the display for inputting the song title.

When you enter the song title (page 45), the search function calls up all records that contain the entered word or words.

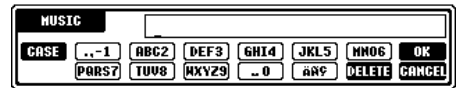

■ [B] KEYWORD

Searches by keyboard. Press this button to call up the display for inputting the keyword.

When you enter the keyword (page 45), the search function calls up all records that contain the entered word or words. You can search several different keywords simultaneously by inserting a separator (comma) between each. The search function finds and displays all records that contain at least one match in the keywords.

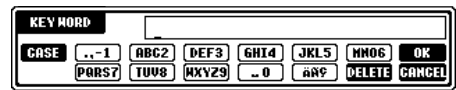

■ [C] STYLE

Searches by style name. Press this button to call up the **STYLE FILE SELECT** display. Press the [A] through [J] button in the display to select the desired accompaniment style. This convenient function lets you find all songs that use a certain accompaniment style.

NOTE

The STYLE FILE SELECT display can only be used to select the style name for searching; it cannot be used to call up the actual accompaniment style.

■ [D] BEAT

Searches by beat or rhythmic feel.

■ [E] SEARCH AREA

Selects a specific location for searching. You can further narrow down your search by using the SEARCH 1 and 2 selections.

■ [F]~[H] CLEAR

Clears the entered item at left.

■ [1▲▼] TEMPO FROM

You can also narrow your search by specifying a tempo range. This lets you set the minimum tempo for the search. Press the [▲▼] buttons simultaneously to instantly reset the tempo value to the minimum.

■ [2▲▼]TEMPO TO

You can also narrow your search by specifying a tempo range. This lets you set the maximum tempo for the search. Press the [▲▼] buttons simultaneously to instantly reset the tempo value to the maximum.

■ [3▲▼]~[5▲▼] GENRE

Selects the specific music genre for searching. The available range includes all genres (ANY), the preset genres, and any genres you've entered yourself (page 69).

■ [8▼] CANCEL

Press this to cancel the operation and return to the previous display.

Editing Records — Music Finder Record Edit

From this display, you can call up existing records and edit them to suit your preferences. You can even use this to create your own Music Finder records.

1 Press the [8 ▲▼] (RECORD EDIT) button in the MUSIC FINDER display.



2 Change/clear the record data. You can also register new records. For details about all settings and operations, see below.

NOTE
You can also change/clear a preset record. To avoid changing/clearing the record, register the record as a new record after editing.

NOTE
All Music Finder records can be stored together as a single file (page 140). When calling up a stored file, a message appears prompting you to replace or append the records as desired.

- Replace:**
All Music Finder records currently in the instrument are deleted and replaced with the records of the selected file.
- Append:**
The records called up are added to the vacant record numbers.

■ **[A] MUSIC**

Selects the music or song title for editing. Press the button to call up the display for inputting the music or song title, then edit the name as desired.

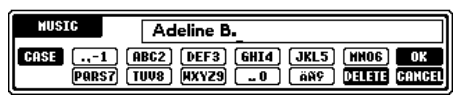

■ **[B] KEYWORD**

Selects the keyword for editing. Press the button to call up the display for inputting the keyword, then edit it as desired.

You can enter several different keywords by inserting a separator (comma) between each.



■ **[C] STYLE**

Selects the style name for editing. Always enter the name when a new record is registered. Press the button to call up the **STYLE FILE SELECT** display. Press the [A] through [J] button in the display to select the desired style you want to change/clear/register.

NOTE
The **STYLE FILE SELECT** display can only be used to select the style name for record editing; it cannot be used to call up the actual accompaniment style.

■ **[D] BEAT**

Selects the beat (time signature) for editing. When another file is selected by pressing the [C] button, the current beat setting is replaced with the beat setting of the selected file.

■ **[E] FAVORITE**

Adds the selected record to the **FAVORITE** page (page 69).

■ **[F]~[H] CLEAR**

Clears the entered item at left.

NOTE
Keep in mind that the Beat setting made here is only for the Music Finder search function; this does not affect the actual Beat setting of the accompaniment style itself.

■ **[I] DELETE RECORD**

Clears the selected record. The deleted record number becomes empty. When you press this button, a message appears prompting you to execute, abort or cancel the operation.

- YES** Press this to clear the record and close the display.
- NO** Press this to close the display without clearing the record.
- CANCEL**..... Press this to close the message box and return to the previous display.

■ **[J] NEW RECORD**

Registers a new record. The smallest available empty record number is used for registering. When you press this button, a message appears prompting you to execute, abort or cancel the operation.

YES Press this to register the record and close the display.

NO Press this to close the display without registering the record.

CANCEL..... Press this to close the message box and return to the previous display.

NOTE
The maximum number of records is 2500, including internal records.

■ **[1▼▲] TEMPO**

Determines the tempo for the selected style. When changing the style with the [C] button, the tempo is automatically changed to that of the changed style.

■ **[3▼▲]~[5▼▲] GENRE**

Indicates and changes the genre to which the selected record is assigned. The available range includes all preset genres as well as any you've entered yourself.

■ **[6▼▲] GENRE NAME**

For entering a genre name. Press the button to call up the display for inputting the genre name, then edit the name as desired. A maximum of 200 genre names can be stored.

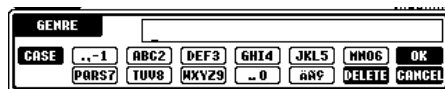

The genre name you input becomes effective when the current record is edited (overwritten) by pressing the [8▲] (OK) button, or when a new record is registered by pressing the [J] (NEW RECORD) button.

If you exit from the MUSIC FINDER EDIT display without actually editing or registering a record, the input genre name is deleted.

■ **[8▲] OK**

Executes all editing and changes to the record. When you press this button, a message appears prompting you to execute, abort or cancel the operation.

YES Press this to replace the record and close the display.

NO Press this to close the display without replacing the record.

CANCEL..... Press this to close the message box and return to the previous display.

■ **[8▼] CANCEL**

Press this to cancel the operation and return to the **MUSIC FINDER** display.

NOTE
To maintain the edited and registered data, make sure to save all Music Finder records as a file (page 140). If no saved, the data will be lost when another Music Finder file is called up or the factory-programmed settings are restored (page 140).

Song Playback

Here you'll learn how to play back songs. Songs include the internal songs of the instrument, performances you've recorded yourself using the recording functions (page 90), and commercially available song data. You can use this highly versatile feature in a variety of ways — playing along on the keyboard with the recorded song, as well as practicing and learning new music with the Repeat (page 77) function. You can also display the music notation and lyrics in the LCD.

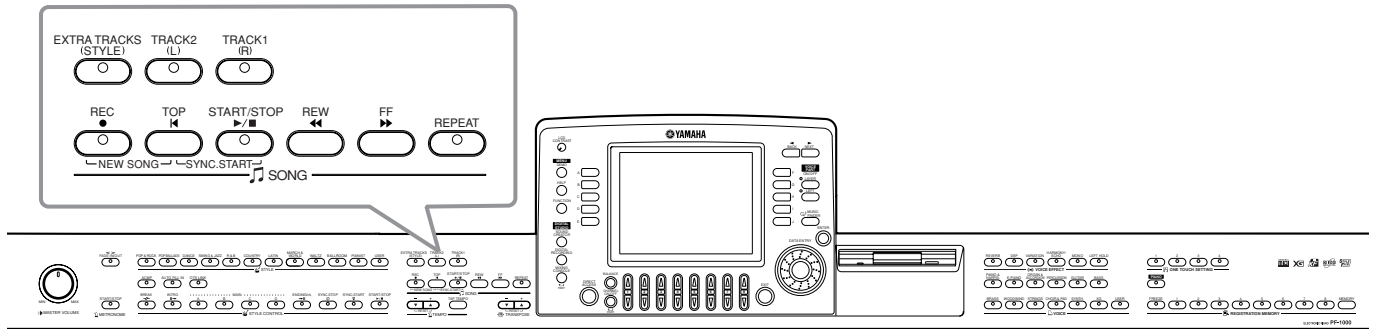

Compatible Song Types

- Internal songs (Song Book)
- Song data on included disk (50 greets for the piano)
- Commercially available song data



Disks having this logo mark feature song data compatible with GM (General MIDI).

NOTE

Commercially available music data is subject to copyright restrictions, and is intended only for your own personal use.



Disks having this logo mark feature song data compatible with Yamaha's XG format. XG is a significant enhancement of the "GM system level 1" standard, providing more voices, greater editing control, and support for multiple effect sections and effect types.

NOTE

For more information on the song file types compatible with the PF-1000, see page 148.



Disks having this logo mark feature song data compatible with Yamaha's DOC (Disk Orchestra Collection)



Disks having this logo mark feature song data compatible with Yamaha's original MIDI file format.

- Songs you recorded (page 90) and stored to the PF-1000 or disk.

Song Playback

Playing the Internal Songs

1

The MAIN screen displays the following information: **Grand Piano**, Lyrics, Score, Hearin'Beat, 4bar2 4bar, and NewBank. A hand icon points to button A on the left side of the screen.

NOTE

If the **MAIN** screen (at left) is not displayed, press the **[DIRECT ACCESS]** button followed by the **[EXIT]** button.

NOTE

You can also make a variety of other settings (such as tempo, voice selection, etc.) and have them automatically called up when you play back the song (page 102).

2

2-1 Select the **PRESET** tab with the **[BACK]** button.

2-2 Open a folder and select a song to be played back.

The SONG screen shows a list of folders: **Song Back** and **DemoSongs**. A hand icon points to button A on the left side of the screen.

NOTE

You can enable the **Synchro Start** for the song by simultaneously pressing the **[TOP]** button and the **SONG [START/STOP]** button. The song starts as soon as you play the keyboard. You can also use this function along with the **Style's Synchro Start** function (page 60).

NOTE

You can have the volume automatically fade in and fade out at the beginning and end of the song. Simply press the **[FADEIN/OUT]** button at the start of song playback to fade in the song, and press it again at the end of the song to fade out.

3 The song starts.

The diagram shows the following controls: **REC**, **TOP**, **START/STOP**, **REW**, **FF**, and **REPEAT**. A hand icon points to the **START/STOP** button.

Adjust the tempo by using the **TEMPO [-][+]** buttons (page 50) or the **[TAP TEMPO]** button. You can even change the playback speed by tapping out the tempo — simply tap the **[TAP TEMPO]** button twice.

NOTE

Songs can also be played back continuously. Set **SONG CHAIN PLAY** to **ON** from the **SONG SETTING** display (page 126).

To stop the song immediately, press the button again.

Press the **EXIT** button in order to go back to the previous screen.

NOTE

Make sure that the **Language** setting for the instrument (page 140) is the same as that of the file name of the song that you are playing back.

Simultaneously Playing a Song and an Accompaniment Style

When playing back a song and an accompaniment style at the same time, channels 9 - 16 of the song data are replaced with accompaniment style channels — allowing you to use the auto accompaniment styles and features in place of the accompaniment parts of the song. Make the settings below and play your own chord substitutions in place of the song's chord data.

- [ACMP] buttonON
- [AUTO FILL IN] buttonON

- 1** Select the song and start playback by pressing the SONG [START/STOP] button.
- 2** Select the desired accompaniment style.
- 3** Start the style by pressing the STYLE CONTROL [START/STOP] button.
- 4** While the song is playing, insert a break or change sections (with the STYLE section buttons.)
Fill-in patterns play when you switch sections.



The style automatically stops when the song finishes or is stopped.

NOTE

Some of the internal songs have been created using the accompaniment styles. For these songs, the accompaniment styles are automatically started when starting song playback.

NOTE

The accompaniment stops when you stop the song. If the accompaniment style is playing and you start the song, the accompaniment automatically stops. However, for internal songs that use accompaniment styles, the accompaniment style is not stopped.

Playing Back Songs on Disk

Insert the disk into the drive.

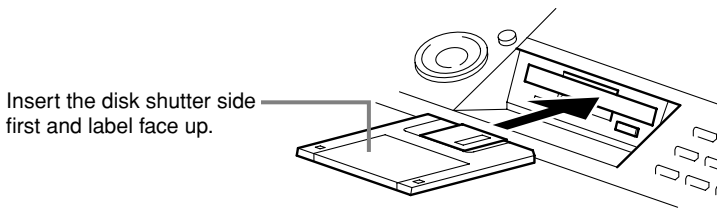

The method for playing back is the same as in the “Playing the Internal Songs” instructions (page 74), except that you should select **FLOPPY DISK** page in the **SONG** display.

Other Playback-related Operations

Repeat / Rewind / Fast forward

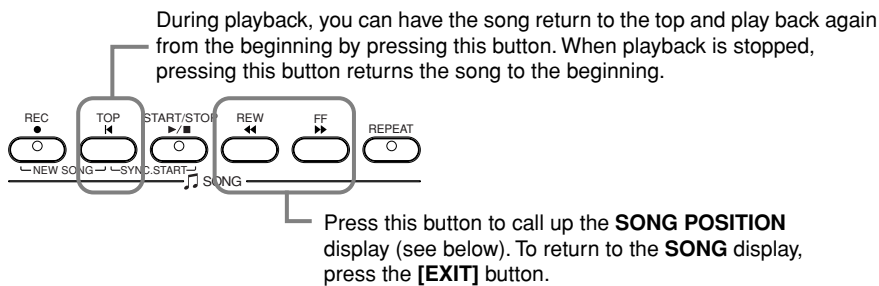

NOTE
Before proceeding, make sure to read the section “Handling the Floppy Disk Drive (FDD) and Floppy Disk” (page 6).

NOTE
You can set whether or not the PF-1000 automatically calls up the first disk song when a disk is inserted (page 139).

NOTE
Some song data for the PF-1000 has been recorded with special “free tempo” settings. During playback of such song data, the measure numbers shown in the display will not correspond to the actual measure; this only serves as a reference as to how much of the song has been played back.

NOTE
Songs containing a large amount of data may not be able to be read properly by the instrument, and as such you may not be able to select them. The maximum capacity is about 200–300KB, however this may differ depending on the data contents of each song.

NOTE
Phrase Mark
This data specifies a certain location in the song data.

SONG POSITION display

When “**BAR**” is selected, you can specify a measure number (counted from the beginning of the song) by using the **[REW]** and **[FF]** buttons.
When “**PHRASE MARK**” is selected, specify the phrase mark number by using the **[REW]** and **[FF]** buttons.

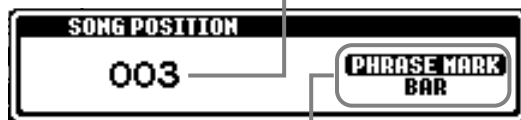

“**PHRASE MARK**” is shown only when the song contains phrase marks. Press the **[J]** button to toggle between “**BAR**” and “**PHRASE MARK**,” then use the **[REW]** and **[FF]** buttons to select the desired measure or phrase mark.

Adjusting the Volume Balance / Muting Specific Channels

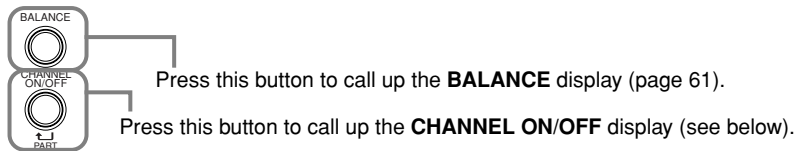

CHANNEL ON/OFF display

SONG		CHANNEL ON/OFF																
1	2	3	4	5	6	7	8	9	10	11	12	13	14	15	16	17	18	
ON	OFF	ON	OFF	ON	OFF	ON	ON	ON	ON	ON	ON	ON	ON	ON	ON	ON	ON	ON

Select the **[SONG]** tab with the **[CHANNEL ON/OFF]** button, and mute the desired channel by setting it to **[OFF]**. To **solo** a channel (only that channel will sound), hold down the appropriate button corresponding to the channel. To release the solo for the channel, press that channel’s button again.

NOTE
Channel
Refers to the MIDI channel in the song data. The channels are assigned as shown below for the PF-1000.

Song
1 - 16

Accompaniment Style
9 - 16

Muting Specific Parts — Track1/Track2/Extra Tracks

This feature lets you mute certain parts of the song (Track1, Track2, Extra Tracks), and play back only those parts you want to hear. For example, if you want to practice the melody of a song, you can mute just the right-hand part and play that part yourself.

1 Select the song to be played back (page 73).

2 Use this button to turn on/off the additional performance parts (all but the right hand/left hand).

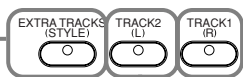

Use this button to turn on/off the right-hand part.

Use this button to turn on/off the left-hand part.

NOTE

You can change the channel assignments for Track 1 and Track 2 (page 126), letting you specify which parts are muted when pressing the **[TRACK 1]/[TRACK 2]/[EXTRA TRACKS]** buttons.

NOTE

All tracks are automatically set to on when selecting a different song.

3 Start the song.
Adjust the tempo by using the TEMPO [-][+] buttons (page 50).

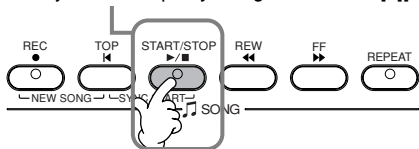

To stop the song, press the



Repeat Playback of a Specific Range

This feature allows you to specify a certain range of the song (between Point A and Point B), and play it back repeatedly.

1 Play back the song (page 74, 76).

2 Press this button at the point you want the repeating phrase to start (Point A).
Press this button at the point you want the repeating phrase to end (Point B).

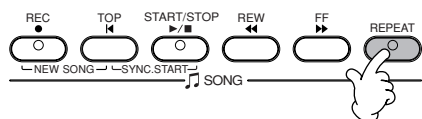

NOTE

You can also specify Points A and B when the song is stopped. Set Point A by pressing the **[REPEAT]** button, then use the **[FF]** button to move to the desired end location, then set Point B by pressing the **[REPEAT]** button again.

3 After an automatic lead-in (to help guide you into the phrase), the range from point A to point B is played back repeatedly.
Regardless of whether the song is playing back or is stopped, pressing the **[TOP]** button returns to point A.

NOTE

Point B cannot be selected unless Point A has been selected first.

NOTE

Specifying only Point A results in repeat playback between Point A and the end of the song.

NOTE

The specified A and B points will be erased when selecting a different song number, cancelling the Repeat function, or selecting a different repeat mode — such as Phrase Repeat or repeat in Song Chain Play (page 126).

4 Stop the song.



To cancel the Repeat function, press the



Displaying Music Notation — Score

With this feature, you can have the notation automatically shown on the display as the song plays. This can be used with your own recordings as well as the internal Demo songs.

1 Select the desired song (page 74, 76).



2

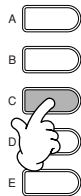

3

Enables/disables display of the left-hand key range. Depending on other settings, this parameter may be unavailable and may appear grayed out. If this is the case, go to the detailed setting display (shown below; use the [8▲▼] buttons) and set the **LEFT CH.** parameter to any channel except "AUTO." Or, go to the **SONG SETTING** display in the **Function** menu (page 126) and set the **TRACK 2** parameter to any channel except "OFF."

Enables/disables display of the right-hand key range. Channel 1 is automatically selected when [TRACK1] is set to [OFF] from the **SONG SETTING** display (page 126).

Enables/disables display of the lyrics. If the selected song does not contain lyric data, lyrics are not displayed.

Enables/disables display of the chords. If the selected song does not contain chord data, chords are not displayed.

Enables/disables display of the note name (pitch).

Determines the display resolution (or zoom level) of the notation.
SMALL Notation is shown in small size.
LARGE Notation is shown in large size.

This calls up the detailed setting display for notation. For details, see the next page.

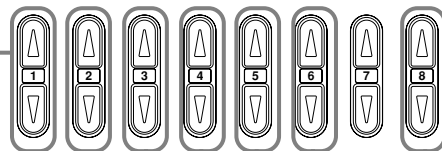

NOTE

If the **MAIN** screen (at left) is not displayed, press the **[DIRECT ACCESS]** button followed by the **[EXIT]** button.

NOTE

The displayed notation is generated by the PF-1000 based on the song data. As a result, it may not be exactly the same as commercially available sheet music of the same song — especially when displaying notation of complicated passages or many short notes.

NOTE

Some song data for the PF-1000 has been recorded with special "free tempo" settings. For such song data, the tempo, beat, measure and music notation will not be displayed correctly.

NOTE

[RIGHT] and **[LEFT]** cannot be turned off at the same time.

NOTE

The note name is indicated at the left of the note. When the space between the notes is too small, the indication may be moved to the top left of the note.

NOTE

You can increase the number of measures that will be displayed by decreasing the other items to be displayed (parts, lyrics, chords, etc.).

NOTE

When accidentals (sharp and flats) and notes cannot be displayed on one line, they are displayed in the next line from the middle of the measure.

NOTE

The notation functions cannot be used to create song data by inputting notes. For information on creating song data, see page 94.

Detailed Settings for Notation

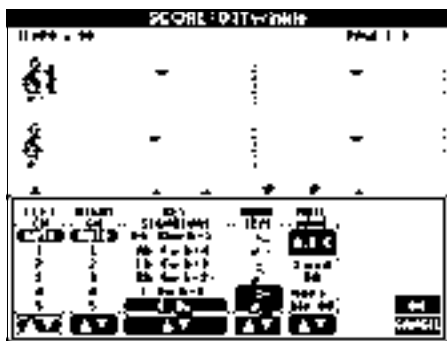

NOTE
When "LEFT" and "RIGHT" are set to the same channel, the notation of the right-hand notes and left-hand notes are displayed in piano format (two connected staves).

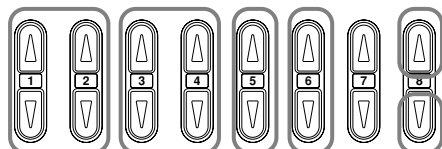

■ [1▲▼] LEFT CH/[2▲▼] RIGHT CH

This determines the Left channel (channel for the left-hand part) and Right channel (channel for the right-hand part). This setting returns to **AUTO** when a different song is selected.

AUTOThe channels for the right- and left-hand parts are assigned automatically — setting the parts to the same channel as the channel which is specified in the **SONG SETTING** display of the **Function** menu (page 122).

1-16Assigns the part to the specified channel, 1- 16.

OFF (LEFT CH only)No channel assignment.

■ [3▲▼], [4▲▼] KEY SIGNATURE

This lets you enter key signature changes in the middle of a song, at the stopped position, allowing you to transpose key at any point within a song. For a list of the key signatures, with their relative minor keys and accidentals, see the chart below.

Key Signatures and Accidentals

C Maj (A min)	G Maj (E min)	D Maj (B min)	A Maj (F [♯] min)	E Maj (C [♯] min)	B Maj (G [♯] min)	F [♯] Maj (D [♯] min)	C [♯] Maj (A [♯] min)
C [♭] Maj (A [♭] min)	G [♭] Maj (E [♭] min)	D [♭] Maj (B [♭] min)	A [♭] Maj (F min)	E [♭] Maj (C min)	B [♭] Maj (G min)	F Maj (D min)	

The \circ note indicates the root note of the major key, and the \bullet note indicates the root of the relative minor.

■ [5▲▼] QUANTIZE

This gives you control over the note resolution in the notation, letting you shift or correct the timing of all displayed notes so that they line up to a particular note value. Make sure to select the smallest note value which is used in the song.

Note resolution:

1/4 note, 1/8 note, 1/16 note, 1/32 note, 1/4 note triplet, 1/8 note triplet, 1/16 note triplet, 1/32 note triplet

NOTE
Short notes and ornamented notes (such as trills and grace notes) which are shorter than the Note resolution will not be displayed in the notation.

■ [6▲▼] NOTE NAME

Select the Note Name type when "NOTE" (page 78) is set to ON.

ABC Note names are indicated as letters (C, D, E, F, G, A, B).

Fixed Do Note names are indicated in solfeggio and differ depending on the selected language (page 49).

English Do Re Mi Fa Sol La Ti

French Ut Re Mi Fa Sol La Si

Italian Do Re Mi Fa Sol La Si

German Do Re Mi Fa Sol La Si

Spanish Do re Mi Fa Sol La Si

Japanese ドレミファソラシ

Movable Do Note names are indicated in solfeggio according to the scale intervals, and as such are relative to the key. The root note is indicated as Do. For example, in the key of G major the root note of Sol would be indicated as Do.

As with "Fixed Do," the indication differs depending on the selected language.

■ [8▲] OK

This closes the detailed setting display and starts generating the notation. You can also execute this by pressing the [ENTER] button on the panel.

■ [8▼] CANCEL

This closes the detailed setting display without changing the settings. You can also execute this by pressing the [EXIT] button or [RECORD] button on the panel.

NOTE

You can select the display pages (one before and after) by the using the [BACK]/[NEXT] buttons or the pedal (page 128).

Displaying the Lyrics

This function lets you display the lyrics while the song is playing back — making it easy to sing along with your performance or song playback.

1 Select the desired song (page 74, 76).



NOTE

The language used for lyrics display depends on the particular lyric data. If the lyrics are garbled or unreadable, you can remedy this by changing the "LYRICS LANGUAGE" setting from the **SONG SETTING** display (page 122).

3

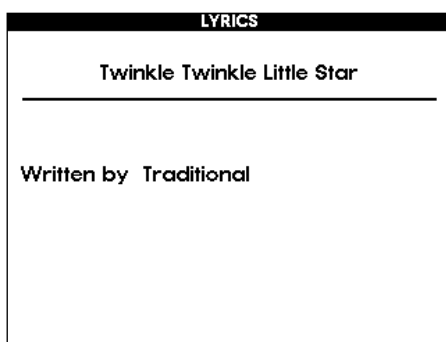

NOTE

If the selected song does not contain lyric data, lyrics are not displayed.

NOTE

If the selected song contains chord data, chord names are displayed with the lyrics.

4

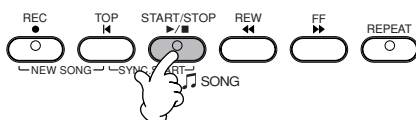



Start the song.

NOTE

The contents of the display can also be shown on a connected TV (page 133, 142).

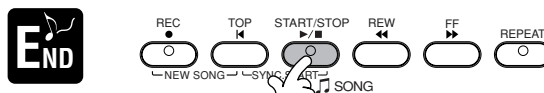
5 The lyrics are in reverse display along with song playback.



Stop the song.
To return to the previous page, press the  button.

NOTE

The lyrics can be changed (page 105).

Saving and Recalling Custom Panel Setups — Registration Memory

Registration Memory is a powerful feature that lets you set up the PF-1000 just as you want — selecting specific voices, styles, effect settings etc. — and save your custom panel setup for future recall. Then, when you need those settings, simply press the appropriate REGISTRATION MEMORY button.

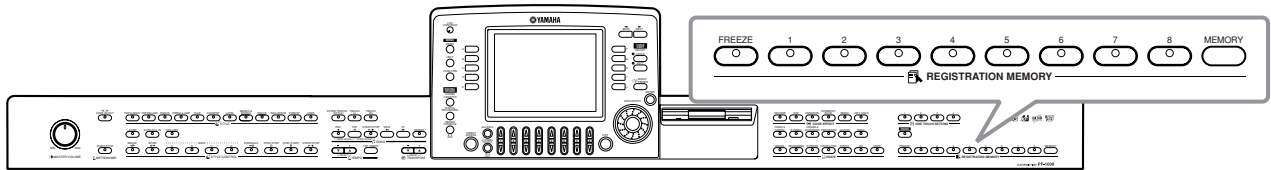

Registering Panel Setups — Registration Memory

This shows you how to register your custom panel settings to the REGISTRATION MEMORY buttons. Make all the settings you want with the panel controls, and Registration Memory will “remember” them for you.

NOTE

Keep in mind that songs or styles on disk cannot be registered to Registration Memory. If you want to register a disk-based song or style, copy the relevant data to “USER” in the SONG/STYLE display (page 38) and register the data separately.

1 Set up the panel controls as desired.

For a list of the settings that can be registered, refer to the separate Data List (Parameter Chart).

2

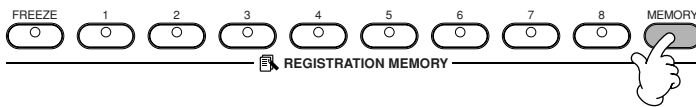

3

Select the desired parameter groups for the settings you want to register. You can also use the [DATA ENTRY] dial to navigate in this display. To register a parameter group, checkmark the corresponding box. Groups left without checkmarks will not be included in the Registration Memory setting. This allows you to maintain certain settings, even when switching among Registration Memory presets. You can also use the Freeze function (page 84) to override the Registration Memory changes — letting you prevent certain panel settings from being changed.



Buttons F, G, H, I, and J. **Buttons F, G, and H:** Cancels the registration and returns to the MAIN display. You can also use the [EXIT] button.

Button I: Enters a checkmark to the selected box. You can also use the [ENTER] button.

Button J: Removes the checkmark from the selected box. You can also use the [ENTER] button.



Press the desired number button for registering the settings.

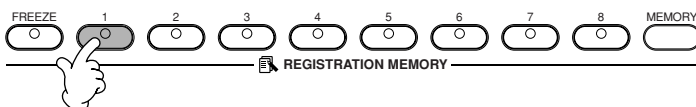

Indicator is green..... The panel setting is registered, but not selected.

Indicator is red The panel setting is registered and is currently selected.

Indicator is off The panel setting is not registered.

NOTE

The registrations registered here will be lost when the power is turned off, unless you perform the Save operation explained on the next page.

NOTE

Any data that was previously registered to the selected REGISTRATION MEMORY button (indicator is green or red) will be erased and replaced by the new settings.

Saving Your Registration Memory Setups

The settings registered to the **REGISTRATION MEMORY [1]-[8]** buttons are saved as a single file.

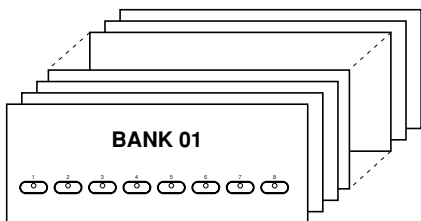

All settings registered to buttons **[1]-[8]** are referred to as a “bank.” The banks can be saved to “USER” or “FLOPPY DISK” as Registration bank files.

NOTE
Keep in mind that the size of the Registration bank files and the memory space they occupy depends on the amount of functions set in each.

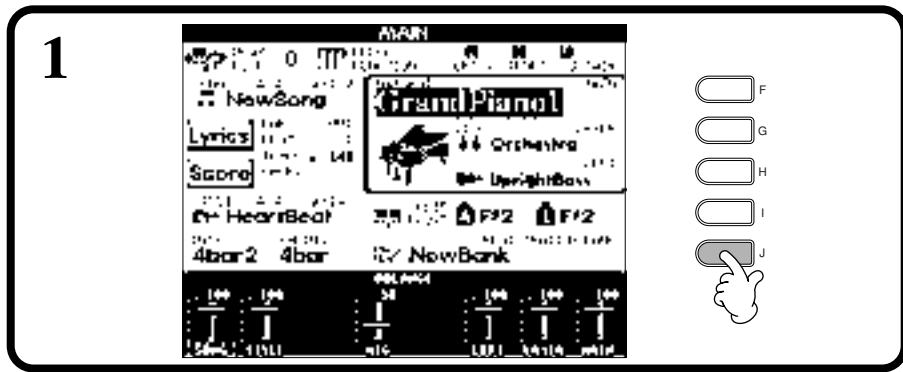

NOTE
Press the **[DIRECT ACCESS]** button and **[EXIT]** button to call up the MAIN display.

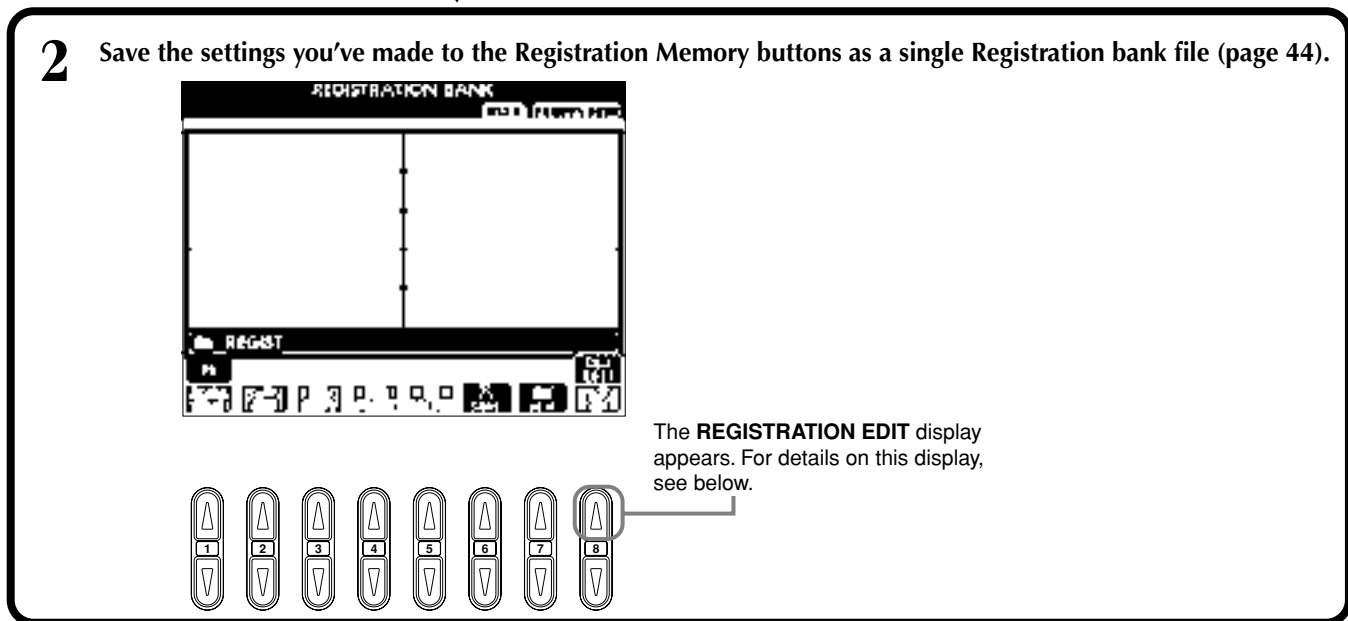

The **REGISTRATION EDIT** display appears. For details on this display, see below.

REGISTRATION EDIT display

The contents of the current Registration Memory bank (REGIST.) are listed in the **REGISTRATION EDIT** screen. The names of the stored Registration Memory presets are shown in the display and the indicators of the relevant **REGISTRATION MEMORY** buttons are lit in green.

From this screen, you can select, name, or delete the Registration Memory presets.

Select Press the **[A] - [J]** buttons. The REGIST. display is linked to the **REGISTRATION MEMORY [1] - [8]** buttons. When you select the Registration Memory preset in the display, the related button turns on (indicator is red).

Name This operation is the same as that in “Naming Files and Folders” (page 41) in “Basic Operations — Organizing Your Data.”

Delete This operation is the same as that in “Deleting Files/Folders” (page 43) in “Basic Operations — Organizing Your Data.”

NOTE

The result of the Name/Delete operation will be lost when the power is turned off unless you return to the **REGISTRATION BANK** display by pressing the **[8▼]** (UP) button and save the data (page 44).

Recalling a Registration Memory Setup

You can recall all of the panel settings you've made — or only those you specifically want or need. For example, if you de-select "STYLE" in the **REGISTRATION MEMORY** display, you can keep the currently selected style even when you change the Registration Memory preset.

Recalling the Registered Settings

Select the desired bank in the **REGISTRATION BANK** display (page 83). Press the appropriate **REGISTRATION MEMORY** button (any whose indicators are green) to recall the desired settings.

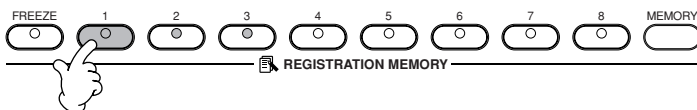

NOTE
You can program your Registration Memory presets to be called up in sequence, in any order you desire. Once programmed, the presets 1 - 8 can be selected in sequence with the **[BACK][NEXT]** buttons or the pedal (page 131).

Selecting the Freeze Settings

1

Call up the "FREEZE" page from the **REGIST.SEQUENCE/ FREEZE/VOICE SET** screen (page 131).

2

Enters a checkmark to the selected box.

Removes the checkmark from the selected box.

Select the Freeze settings.

3 Press the **[FREEZE]** button. When Freeze is active (lamp is lit), the settings you specified in the Freeze page will be maintained or left unchanged, even when changing Registration Memory presets.

4 Press the appropriate **REGISTRATION MEMORY** button (any whose indicators are green) to recall the desired settings.

Editing Voices — Sound Creator

The PF-1000 has a Sound Creator feature that allows you to create your own voices by editing some parameters of the existing voices. Once you've created a voice, you can save it as a USER voice for future recall.

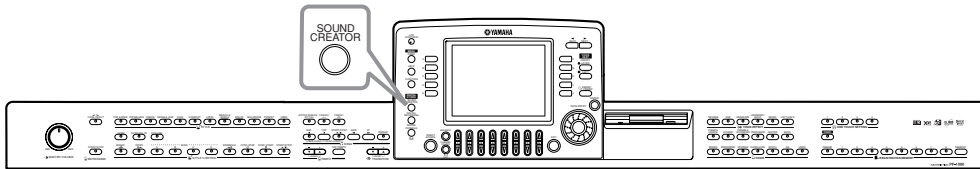

NOTE

- The Voice can be edited in realtime while playing back a song/style.
- Keep in mind that adjustments made to the parameters may not make much change in the actual sound depending on the original settings of the voice.

Operation

1 Press the [F], [G] or [H] button to select the Part (MAIN, LAYER or LEFT) containing the voice you wish to edit.

2 Press the [SOUND CREATOR] button.

NOTE

The voice can also be selected in the SOUND CREATOR display.

CAUTION

The settings are lost if the edited part's voice is switched to another voice. Important data should be saved to User Drive or floppy disk.

3 Edit the voice parameters.

The operations for each function selected in this step are covered in detail, starting on page 87.

NATURAL VOICE

Indicates the parameters available for editing in this display. These correspond to the parameters/values shown at the bottom of the display.

REGULAR VOICE

Can be used during editing to compare the sound of the original voice with the edited voice.

Select the desired menu by pressing the [NEXT]/[BACK] button.

Select the desired menu. The selected menu is highlighted.

Opens the Save (Voice) display for saving the edited voice as a User voice (page 44).

4 Save the edited voice to the USER drive (Flash ROM) as a USER voice (page 44).

5 Press the [USER] button to select the edited voice, and play the keyboard.

SOUND CREATOR Parameters

PIANO	Determines the parameters unique to piano sounds, such as tuning curve or sustain sampling. This page is available only when the Natural piano voice is selected.
COMMON	Determines the common settings such as voice volume or octave.
SOUND	Determines the timbre/EG (Envelope Generator)/vibrato of the voice (Regular voice only).
EFFECT	Determines the effect depth or type.
HARMONY	Determines the Harmony/Echo settings.

NOTE

The available parameters differ depending on the selected voice type, Regular or Natural (see below).

NOTE

Keep in mind that there are certain parameters whose Sound Creator settings affect only the Main part's voice.

The following parameters are linked to the ones in each display.

Common parameter	Other location	
MONO	VOICE EFFECT (TOP PANEL)	page 58
PORTAMENTO TIME	MIXING CONSOLE	page 118
LEFT PEDAL TYPE	CONTROLLER (FUNCTION)	page 128
LEFT PEDAL SETTING	CONTROLLER (FUNCTION)	page 128
FILTER BRIGHTNESS	MIXING CONSOLE	page 118
FILTER HARMONIC CONTENT	MIXING CONSOLE	page 118
REVERB DEPTH	MIXING CONSOLE	page 119
CHORUS DEPTH	MIXING CONSOLE	page 119
DSP ON/OFF	VOICE EFFECT (TOP PANEL)	page 57
DSP DEPTH	MIXING CONSOLE	page 119
DSP TYPE/VARIATION	MIXING CONSOLE/VOICE EFFECT (TOP PANEL)	page 57,119
HARMONY/ECHO TYPE	HARMONY/ECHO (FUNCTION)	page 132
HARMONY/ECHO VOLUME	HARMONY/ECHO (FUNCTION)	page 132
HARMONY/ECHO SPEED	HARMONY/ECHO (FUNCTION)	page 132
HARMONY/ECHO ASSIGN	HARMONY/ECHO (FUNCTION)	page 132
HARMONY/ECHO CHORD NOTE ONLY	HARMONY/ECHO (FUNCTION)	page 132
HARMONY/ECHO TOUCH LIMIT	HARMONY/ECHO (FUNCTION)	page 132

Natural Voices and Regular Voices

Built into the PF-1000 are two different tone generation sources, Natural and XG. The Natural tone generation source and its voices feature a huge amount of wave memory, giving you enormous and finely detailed expressive power over the sound. The XG source (which powers the Regular voices) provide maximum compatibility with a wide variety of devices and song data.

The maximum amount of polyphony for each tone generation source is set up to best enhance your performance. In general, the songs and styles are played back using the XG source, while the Natural voices are played from the keyboard — allowing you to play the Natural voices with full polyphony, even if the song and style data exceeds the polyphonic limit.

NOTE

Voices sounded with the XG source are divided into two groups. One is the original set of PF-1000 voices (Cool!, Sweet!, Live!), and the other is the conventional XG set.

Natural!	Cool!	Sweet!	Live!	XG
PF-1000-exclusive voices				GM/XG-compatible voices
Natural voices (sounded by Natural tone generation source)	Regular voices (sounded by XG tone generation source)			
Used mainly for keyboard-played voices	For keyboard-played voices, song/style playback*			

* Depending on the particular style selected, a Natural voice may be used for the accompaniment. Usually, songs are played back using the XG voices (page 149); however, you can have them automatically “re-voiced” — using the exceptionally rich and realistic sounds exclusive to the PF-1000 (page 117).

PIANO (Piano Voice has been selected)

The explanations here apply to step #3 on page 85.

Determines the tuning curve, especially for piano voices. Select "FLAT" if you feel the tuning curve of the piano voice does not quite match that of other instruments voices.

- STRETCH** .. Tuning curve particularly for pianos
- FLAT** Tuning curve in which the frequency is octave doubled over the entire keyboard range

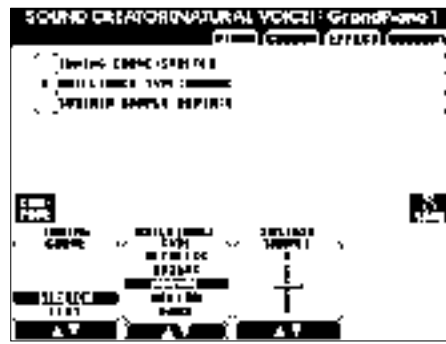

NOTE
The available parameters differ depending on the selected voice.

These controls are used to adjust the brilliance of the tone. This setting affects all Natural voices globally. When other than piano voice (Natural) is selected, set this on EFFECT page. For details, see the EFFECT page (page 89).

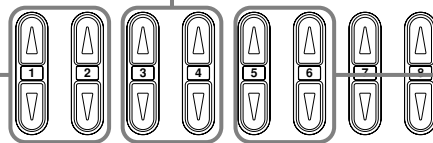

Determines the depth of sustain sampling for the damper pedal.

COMMON

The explanations here apply to step #3 on page 85.

The parameters are the same as for CONTROLLER display. For details, see page 128.

Set the volume of the current edited voice.

Determines the touch sensitivity, or how greatly the volume responds to your playing strength.

- 0 — Produces more dramatic level drops, the more softly you play.
- 64 — Normal response.
- 127 — Produces high volume for any playing strength (fixed)

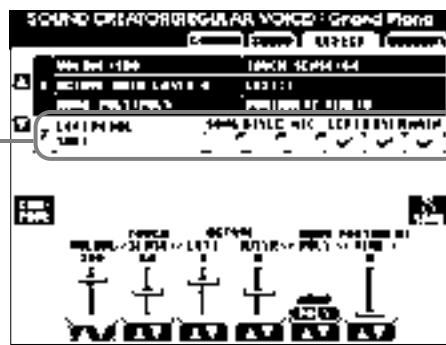

Set the portamento time of each part (MAIN/LAYER/VOICE) (Regular Voice only) (page 118).

This determines whether the voice is played monophonically (Regular Voice only) (page 58).

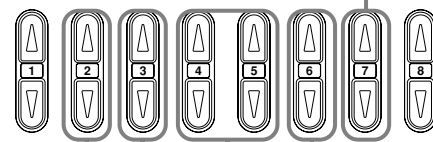

Shift the octave range of the selected voice up or down in octaves. When the Main or Layer part's voice is used, the M/LYR parameter is available; when the Left part's voice is used, the LEFT parameter is available.

SOUND (Regular Voice only)

The explanations here apply to step #3 on page 85.

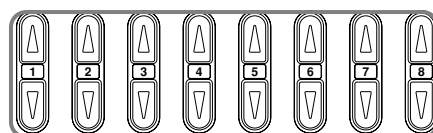
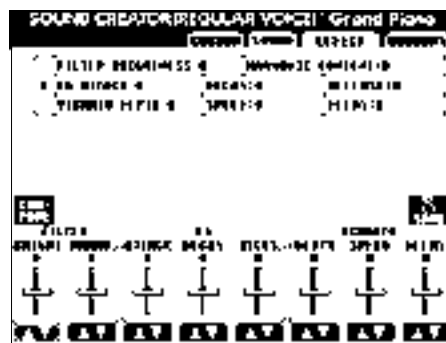

Determines the filter, EG, and vibrato settings (see below).

■ FILTER

FILTER settings determine the overall timbre of the sound by boosting or cutting a certain frequency range.

NOTE

In addition to making the sound either brighter or more mellow, Filter can be used to produce electronic, synthesizer-like effects.

• BRIGHTNESS

Determines the cutoff frequency or effective frequency range of the filter (see diagram). Higher values result in a brighter sound.

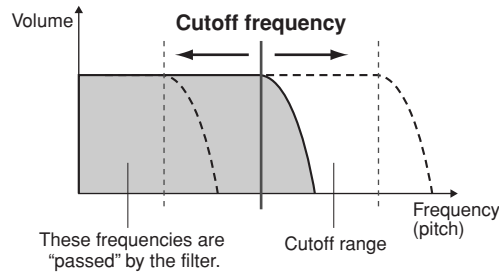

• Harmonic Content

Determines the emphasis given to the cutoff frequency (resonance), set in BRIGHTNESS above (see diagram). Higher values result in a more pronounced effect.

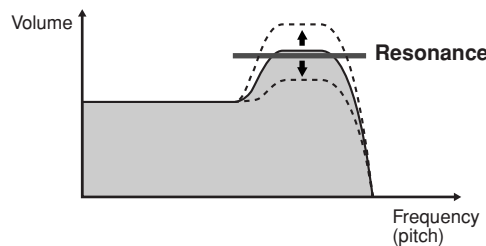

■ EG

The EG (Envelope Generator) settings determine how the level of the sound changes in time. This lets you reproduce many sound characteristics of natural acoustic instruments — such as the quick attack and decay of percussion sounds, or the long release of a sustained piano tone.

• **ATTACK** Determines how quickly the sound reaches its maximum level after the key is played. The higher the value, the slower the attack.

• **DECAY** Determines how quickly the sound reaches its sustain level (a slightly lower level than maximum). The higher the value, the slower the decay.

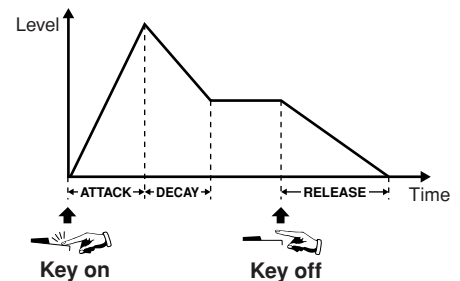

• **RELEASE** Determines how quickly the sound decays to silence after the key is released. The higher the value, the slower the release.

NOTE

If RELEASE is set to a large value, the sustain becomes long.

■ VIBRATO

• **DEPTH** Determines the intensity of the Vibrato effect (see diagram). Higher settings result in a more pronounced Vibrato.

• **SPEED** Determines the speed of the Vibrato effect (see diagram).

• **DELAY** Determines the amount of time that elapses between the playing of a key and the start of the Vibrato effect (see diagram). Higher settings increase the delay of the Vibrato onset.

NOTE

VIBRATO
Creates a wavering in the sound by periodically changing the pitch.

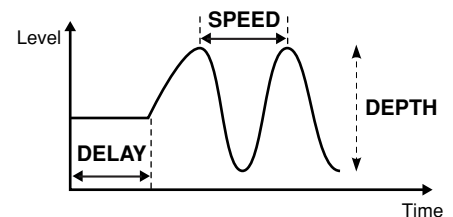

EFFECT

The explanations here apply to step #3 on page 85.

Determines the effect type (Reverb/Chorus/DSP) for the Natural voices. When a regular voice is selected, the DSP type and Variation are set in two separate menus. For information on the effect structure, see page 121; for a list of available effect types, refer to the separate Data List.

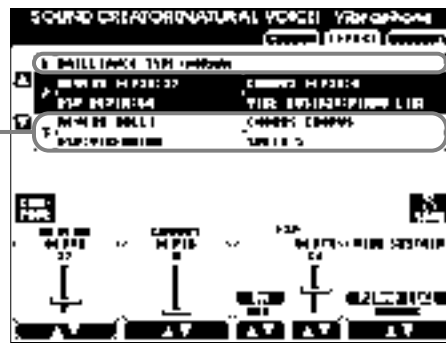

Determines the brilliance of the tone, when a Natural voice is selected. This can also be set from the PIANO page (page 87), when a piano is selected.

- **Metallic** Sharp metallic tone
- **Bright** Bright tone
- **Normal** Standard tone
- **Mellow** Soft and mellow tone
- **Dark** Dark tone

NOTE

- If you select [Bright] or [Metallic] as the type of brilliance, the volume level will increase slightly. In this case, raising the [MASTER VOLUME] may result in distortion. If this happens, lower the volume accordingly.
- "SPEED" parameter is added when selecting VIBE ROTOR DSP type. This parameter enables you to set the speed of vibrato when you select the Vibraphone voice, recreating the effect of a vibrate pedal.

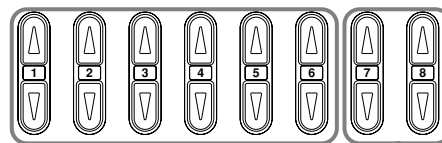

The same as the "Mixing Console" on page 119.

This parameter enables you to select whether the sound is sustained while you press the keys on the keyboard ("PIANO LIKE"), or the sound is sustained only while you press and hold down the sustain pedal, like playing a real vibraphone ("NORMAL") (for Vibraphone voice).

HARMONY

The explanations here apply to step #3 on page 85.

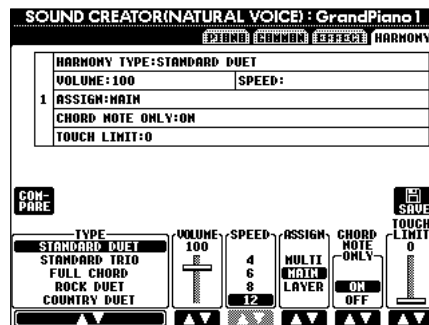

The parameters are the same as for HARMONY/ECHO display of FUNCTION. For details, see page 133.

Recording Your Performances and Creating Songs

— Song Creator

With these powerful yet easy-to-use song creating features, you can record your own keyboard performances and store them for future recall. Several different recording methods are available: Quick Recording (page 91), which lets you record easily and quickly; Multi Recording (page 92), which lets you record several different parts; and Step Recording (page 94), which lets you enter notes one by one. Songs can include not only the voice settings for the keyboard performance (Main, Layer, Left), but also the effects and auto accompaniment parts. The recorded song can be stored to internal memory or floppy disk (page 38, 44).

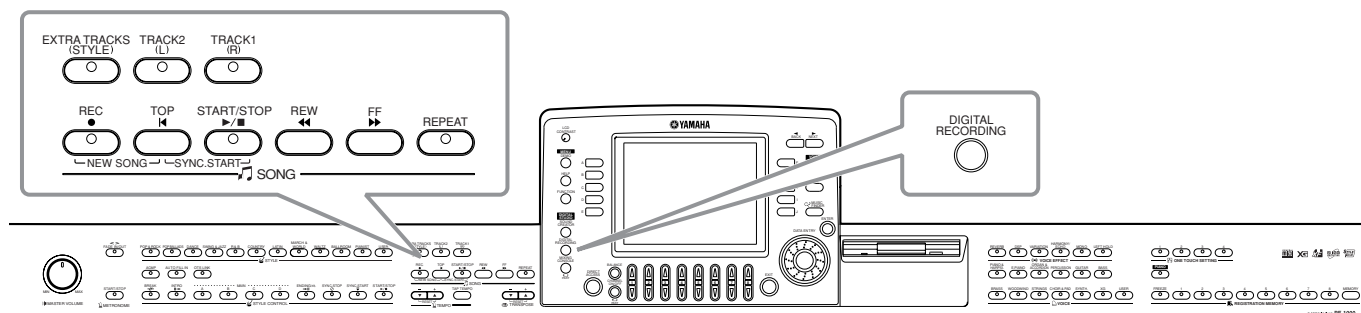

About Song Recording

■ Quick Recording (page 91)

This is the easiest recording method, and lets you quickly record the piano song you are practicing. You can select from three parts: right hand, left hand and auto accompaniment. For example, you can record only your right hand performance, or you can simultaneously record both your right hand and the auto accompaniment.

■ Multi Recording (page 92)

This lets you record a song with several different instrument sounds, and create the sound of a full band or orchestra. Record the performance of each instrument individually and create fully orchestrated compositions. You can also record over an existing part on an internal song or a song on disk with your own performance.

■ Step Recording (page 94)

This method is like writing music notation on paper. It lets you enter each note individually, by specifying the pitch and length. This is ideal for making precise recordings, or for recording parts that are difficult to play.

■ Song Editing (page 100)

The PF-1000 also lets you edit the songs you've recorded by the Quick Recording, Multi Recording and Step Recording methods.

NOTE

- The internal memory capacity of the PF-1000 is about 580KB. Memory capacity for 2DD and 2HD floppy disks is about 720KB and 1.44MB, respectively. When you store data to these locations, all file types of the PF-1000 (Voice, Style, Song, Registration, etc.) are stored together.
- The microphone input signal cannot be recorded.
- Songs recorded on the PF-1000 are automatically recorded as SMF (Standard MIDI File format 0) data. For details on SMF see page 148.
- Playback of the recorded song data can be transmitted from MIDI OUT, letting you play the sounds of a connected external tone generator (page 135).
- The volume level of each channel of the song can be adjusted from the Mixing Console and the settings can be saved. Moreover, even after you've set a voice for your keyboard play during recording, you can record voice selections, so that the voice changes automatically during playback (page 102).

Quick Recording

This is the easiest recording method — perfect for quickly recording and playing back a piano song you're practicing, so you can check your progress.

■ When creating a new song:

1

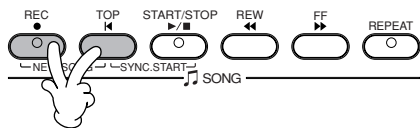

■ When recording over the part of an internal song or a song on disk with your own performance:

1 Select the desired song (page 74, 76).

2 Select the voice and accompaniment style you want to use in the song.

If you want to record to the Layer/Left voices, make sure to set the [LAYER]/[LEFT] buttons to ON. Make any other desired settings (Reverb, Chorus, etc.) as well.

3 Simultaneously hold down the [REC] button and press the button corresponding to the track you want to record.

You can select TRACK 1 or TRACK 2 and the EXTRA TRACKS for recording at the same time.

To record your keyboard performance:

Press either the [TRACK 1] or [TRACK 2] button.

To record the auto accompaniment performance:

Press the [EXTRA TRACKS] button.

To stop recording, press the [REC] button again.

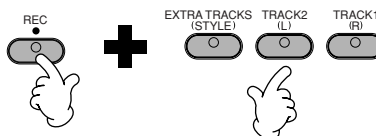

NOTE

If the "LAYER" or "LEFT" button is on before pressing the REC button, the corresponding Layer and Left parts are automatically recorded to different channels.

NOTE

The performance of track 1/2 is recorded to the channel specified in the SONG SETTING display (page 122).

NOTE

You can overdub a second right-hand performance on Track 2 after recording the first right-hand performance (including the layer voices) on Track 1. To do this, set the [LEFT] button to OFF and repeat steps 2 and 3.

NOTE

To pause, press the SONG [START/STOP] button. To resume recording, press the SONG [START/STOP] button again.

NOTE

You can also use the metronome click as a guide while recording. The sound of the metronome is not recorded.

4 Recording starts as soon as you play the keyboard.

You can also start recording by pressing the SONG/STYLE CONTROL [START/STOP] button. Recording can also be started by pressing down the pedal, if the song start/stop function is properly assigned to the pedal (page 128).

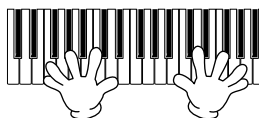

To stop recording, press the [RECORD] button again.

Recording can also be stopped by pressing down the pedal, if the song start/stop function is properly assigned to the pedal (page 128).

■ Play back your new song

To play back the performance you just recorded, return the song to the beginning by using the [TOP] button and press the SONG [START/STOP] button.

Playback stops automatically at the end of the song, and returns to the beginning of the song.

You can edit the recorded song data from the SONG CREATOR (1 - 16) displays (page 103). Press the [6▼] button from the Open/Save display for Song to store the recorded data (page 38, 44).

CAUTION

Turning off the power automatically deletes your recorded performance. If you wish to save the recording, make sure to store it to internal memory (USER drive) or floppy disk (page 38, 44).

Multi Recording

This lets you record a song with several different instrument sounds on up to sixteen channels, and create the sound of a full band or orchestra.

The structure of the channels and parts are shown in the chart below.

Channels	Parts (default settings)	Available parts
1	Voice MAIN	Voice MAIN, LAYER, LEFT Accompaniment style RHYTHM 1 Accompaniment style RHYTHM 2 Accompaniment style BASS Accompaniment style CHORD1 Accompaniment style CHORD2 Accompaniment style PAD Accompaniment style PHRASE1 Accompaniment style PHRASE2 MIDI
2	Voice MAIN	
3	Voice MAIN	
4	Voice MAIN	
5	Voice MAIN	
6	Voice MAIN	
7	Voice MAIN	
8	Voice MAIN	

Channels	Parts (default settings)	Available parts
9	Accompaniment style RHYTHM 1	Voice MAIN, LAYER, LEFT Accompaniment style RHYTHM 1 Accompaniment style RHYTHM 2 Accompaniment style BASS Accompaniment style CHORD1 Accompaniment style CHORD2 Accompaniment style PAD Accompaniment style PHRASE1 Accompaniment style PHRASE2 MIDI
10	Accompaniment style RHYTHM 2	
11	Accompaniment style BASS	
12	Accompaniment style CHORD1	
13	Accompaniment style CHORD2	
14	Accompaniment style PAD	
15	Accompaniment style PHRASE1	
16	Accompaniment style PHRASE2	

About the accompaniment style parts

- Rhythm** This is the basis for the accompaniment, containing the drum and percussion rhythm patterns. Usually one of the drum kits is used.
- Bass** The Bass part uses various appropriate instrument sounds to match the style, such as acoustic bass, synth bass, and others.
- Chord** This is the rhythmic chord backing, commonly used with piano or guitar voices.
- Pad** This part features sustained chords and commonly uses lush sounds such as strings, organ, and choir.
- Phrase** This part is used for various embellishments and riffs that enhance the song, such as brass section accents and chord arpeggios.

■ When creating a new song:

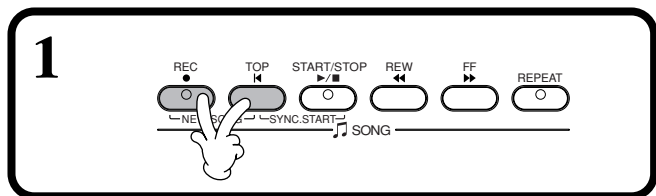

■ When recording over the part of an internal song or a song on disk with your own performance:

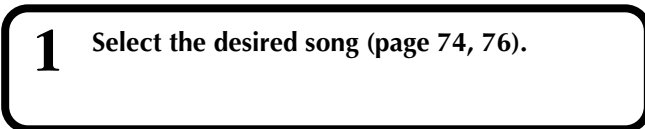

2 Select the desired channel for recording (set it to "REC") simultaneously holding down the [REC] button and pressing the appropriate button [1▲▼] - [8▲▼]. Several channels can be selected at the same time.

REC Enables recording for the channel
ON Enables playback of the channel
OFF Mutes the channel

To cancel or disable recording, press the [REC] button once again.

NOTE
The part is automatically selected when setting the several channels to "REC" at the same time.

3 Select the part you want to assign to the channel to be recorded.

This determines which of the keyboard-played parts (Main/Layer/Left) and the accompaniment style parts (RHYTHM 1/2, BASS, etc.) are recorded to the recording channels selected in step #2.

For a list of the initial default assignments, see page 92.

**4 Recording starts as soon as you play the keyboard.**

You can also start recording by pressing the SONG/STYLE CONTROL [START/STOP] button. The recording can be started/stopped by pressing the pedal if the recording punch in/out function is set to the pedal (page 99).

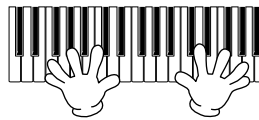
**5 To stop recording, press the [REC] button again.**

You can also use the pedal to stop recording by releasing it, if the recording punch in/out function has been assigned to the pedal (page 99).

**6 Play back your new song.**

To play back the performance you just recorded, return the song to the beginning by using the [TOP] button and press the SONG [START/STOP] button.

Playback stops automatically at the end of the song, and returns to the beginning of the song.

**To record a new part, repeat steps 2 - 6 above.**

You can set previously recorded parts to play back, and monitor them while you record a new part. Continue in this way until you have a finished song.

You can edit the recorded song data from the SONG CREATOR (1 - 16) displays (page 103).

Press the [6▼] button from the Open/Save display for Song to store the recorded data (page 38, 44).

NOTE**When selecting the MIDI part**

- **Setting a single channel to MIDI**
All incoming data received via any of the MIDI channels 1 - 16 is recorded. When using an external MIDI keyboard or controller to record, this lets you record without having to set the MIDI transmit channel on the external device.
- **Setting several channels to MIDI**
When using an external MIDI keyboard or controller to record, this records data only over the set MIDI channel — meaning the external device must also be set to the same channel.

NOTE

A single part (with the exception of MIDI parts) cannot be assigned to several channels.

NOTE

The settings of the recorded parts is stored temporarily until you execute Quick Recording, select a song, or turn the power off.

NOTE

To pause, press the SONG [START/STOP] button. To resume recording, press the SONG [START/STOP] button again.

NOTE

You can also use the metronome click as a guide while recording. The sound of the metronome is not recorded.

CAUTION

Turning off the power automatically deletes your recorded performance. If you wish to save the recording, make sure to store it to internal memory (USER drive) or floppy disk (page 38, 44).

Recording Individual Notes — Step Record

This method lets you create a song by entering notes one by one, without having to perform them in real time. This is also convenient for recording the chords and the melody separately.

Operation

1 Select an existing song (page 74, 76) to which you want to add parts or re-record. If you want to create a new song, simultaneously press the [RECORD] button and the [TOP] button.



2 Press the [DIGITAL RECORDING] button.



3 Press the [A] button to call up the Song Creator display.



4 Using the [BACK]/[NEXT] buttons, select the "1 -16" tab for recording melodies and other parts, or select the "CHD" (Chord) tab for recording chords, and after selecting the "1-16" tab, select a record channel with the [F] (CH) button.



5 Call up the Step Record display by pressing the [G] button.



NOTE
Any voice, effect and other settings you make in the Mixing Console are automatically cancelled when you call up the CHD (Chord) page.

NOTE
The voices in the USER and FLOPPY DISK pages cannot be selected for Step recording. You can select voices from the PRESET page; however, these may sound slightly different from the original voice.

6 First, select the desired voice. To enter the note, first specify the length and loudness in this display, then enter the pitch by actually playing the note on the keyboard.

Moves the cursor position up and down.

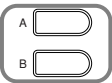

Returns the cursor to the beginning of the song (the first note of the first measure).

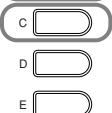

Use these to move the selected event, in units of measures (BAR), beat, and clocks. For information on measure/beat/clock settings, see below.

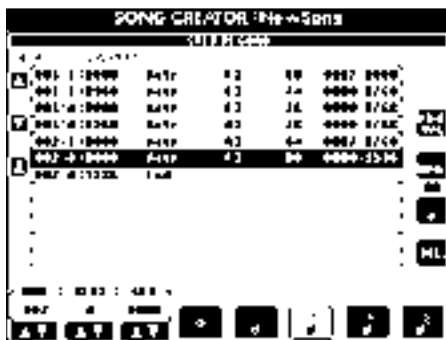

Specifies the type of note to be input next. (Sixteenth notes are available only when recording the melody.) This also determines the position to which the pointer will advance after a note has been entered.

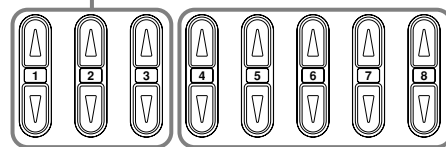

Determines the velocity (loudness) of the note to be entered (only when recording the melody). For information on velocity settings, see below.



Determines the length of the note (as a percentage) from the position at which it is to be entered. (This is available only when recording the melody.) For information on gate time settings, see below.

Each press of this button toggles among the three basic note selectors at the bottom of the display: normal, dotted, and triplet. (This is available only when recording the melody.)

Deletes the event at the cursor.



To close the STEP RECORD display, press the [EXIT] button. Make sure to store the recorded data by pressing the [I] (SAVE) button (page 44).

■ Measure/Beat/Clock

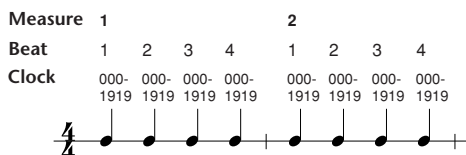

■ Velocity

The table below shows the available settings and the corresponding velocity values.

Kbd. Vel	fff	ff	f	mf	mp	p	pp	ppp
Actual playing strength	127	111	95	79	63	47	31	15

■ Gate Time

The following settings are available:

- Normal 80%
- Tenuto 99%
- Staccato 40%
- Staccatissimo 20%

Manual The gate time (note length) can be specified as a percentage by using the [DATA ENTRY] dial.

Recording Melodies — Step Record (Note)

In this section, we'll show you how to use Step Recording by guiding you through this actual music example, shown at right.

The operations here apply to step 6 on page 95.



1

1-1 Select this note. 1-3 ...press this (to input a tie).

1-2 While holding down this note...

NOTE
The notation display on the instrument may not be accurate, especially for tied notes or longer notes. To have the notation displayed accurately, set the gate time to tenuto by using the [H] button, and input the notes as desired.

2

2-1 Select this note.

2-2 2-3 2-4

3

3-1 Press this button to display the dotted notes.

3-2 Select this note.

3-3

4

4-1 Call up the normal notes by pressing this button.

4-2 Select this note.

4-3

NOTE

To input rests, simply move the measure/beat/clock location for the desired rest time, then input the next note.

■ Play back the newly created melody

Use the [C] (▲) button to move the cursor to the beginning of the song, and press the SONG [START/STOP] button to hear the newly entered notes. To actually enter the recorded data, press the [EXIT] button. The entered data can be edited from the SONG CREATOR (1 - 16) display (page 103).

Recording Chord Changes for the Auto Accompaniment — Step Record (Chord)

The Chord Step recording feature makes it possible to record auto accompaniment chord changes one at a time with precise timing. Since the changes don't have to be played in real time, you can easily create complex, tight chord changes — over which you can record the melody in normal fashion. The operations here apply to step 6 on page 95.

Entering Chords and Sections (Chord Step)

For example, you can input the following chord progression by the procedure described below.

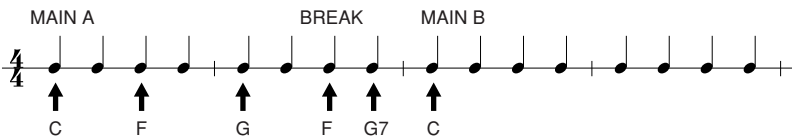

NOTE
Enter the chords by using the currently selected chord fingering method in the Auto Accompaniment section of the keyboard.

1 Press the MAIN [A] button to specify the section, and enter the chords as shown at right.

Select this note value and play the chords indicated at right.

MAIN A

C 001:1:000

F 001:3:000

G 002:1:000

2 Press the [BREAK] button to specify the Break section, and enter the chords as shown at right.

Select this note value and play the chords indicated at right.

MAIN A

BREAK

F 002:3:000

G7 002:4:000

3 Press the MAIN [B] button to specify the section and enter the chord indicated at right.

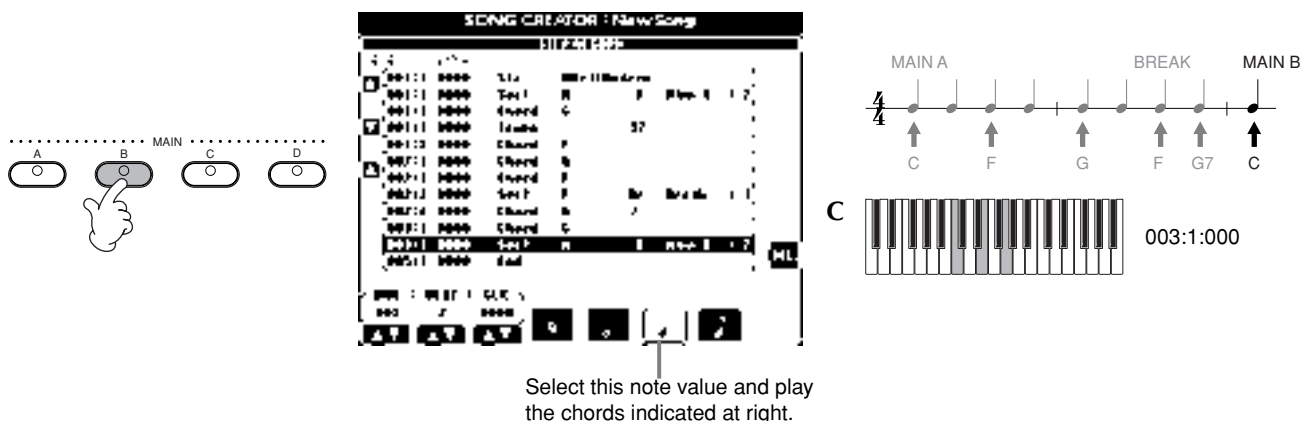

■ Play back the newly created chord progression

Use the [C] (▲) button to move the cursor to the beginning of the song, and press the SONG [START/STOP] button to hear the newly entered notes. To actually enter the recorded data, press the [EXIT] button. The entered data can be edited from the SONG CREATOR (CHD) display (page 104). Finally, press the [F] (EXPAND) button from the SONG CREATOR (CHD) display in order to convert the input data into song data.

NOTE

To enter a fill-in, press the [AUTO FILL IN] button and press one of the MAIN [A]–[D] buttons.

NOTE

END Mark

An “END” mark is shown in the display, indicating the end of the song data. The actual position of the End mark differs depending on the section that is input at the end of the song. When an Ending section is input, the End mark automatically follows the Ending data. When a section other than Ending is input, the End mark is set two measures after the final section. The End mark can be freely set to any position desired.

Select the Recording Options: Starting, Stopping, Punching In/Out — Rec Mode

From this display you can set up how recording is started and stopped for either Quick Recording or Multi Recording. To call up these settings, select the REC MODE display by using the [BACK][NEXT] button, after performing operation steps 1 - 3 on page 94.

These settings determine how recording will start.

Normal

Overwrite recording starts when you press the SONG [START/STOP] button or when you play the keyboard with Synchro standby set to ON.

First Key On

Overwrite recording starts as soon as you start playing the keyboard. This setting also preserves the previous lead-in data, letting you record over the original lead-in without erasing it.

Punch In At

The song plays back normally up to the indicated Punch In measure (set by the [3▲▼] buttons), then starts overwrite recording at that Punch In measure.

Determines the measure at which Punch In overwrite recording starts (when "PUNCH IN AT" is selected).

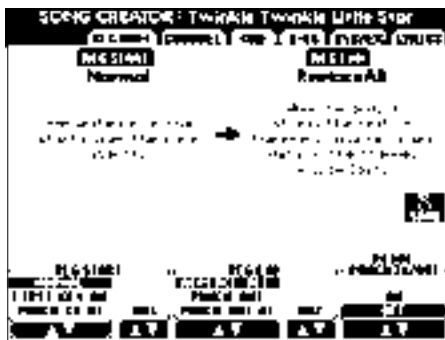

Calls up the SONG display, from which you can save the edited data.

When this is set to ON, you can use the sostenuto (center) pedal to control the punch-in and punch-out points. Press and hold down the sostenuto pedal to record. Recording stops when you release the pedal.

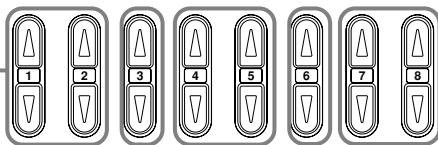

Determines the Punch Out measure — the measure at which Punch In overwrite recording stops (when "PUNCH OUT AT" is selected).

These settings determine how recording will stop as well as what happens to previously recorded data.

Replace All

This deletes all data following the point at which recording is stopped.

Punch Out

This maintains all data following the point at which recording is stopped.

Punch Out At

Overwrite recording continues until the indicated Punch Out measure (set by the [6▲▼] buttons), then stops at that Punch Out measure, after which song playback continues normally.

NOTE

When the Pedal Punch In/Out function is set to ON, the current function assignment of the sostenuto pedal is cancelled.

About Punch In/Out

This feature is useful primarily for re-recording or replacing a specific section of an already recorded channel. The illustrations below indicate a variety of situations in which selected measures in an eight-measure phrase are re-recorded.

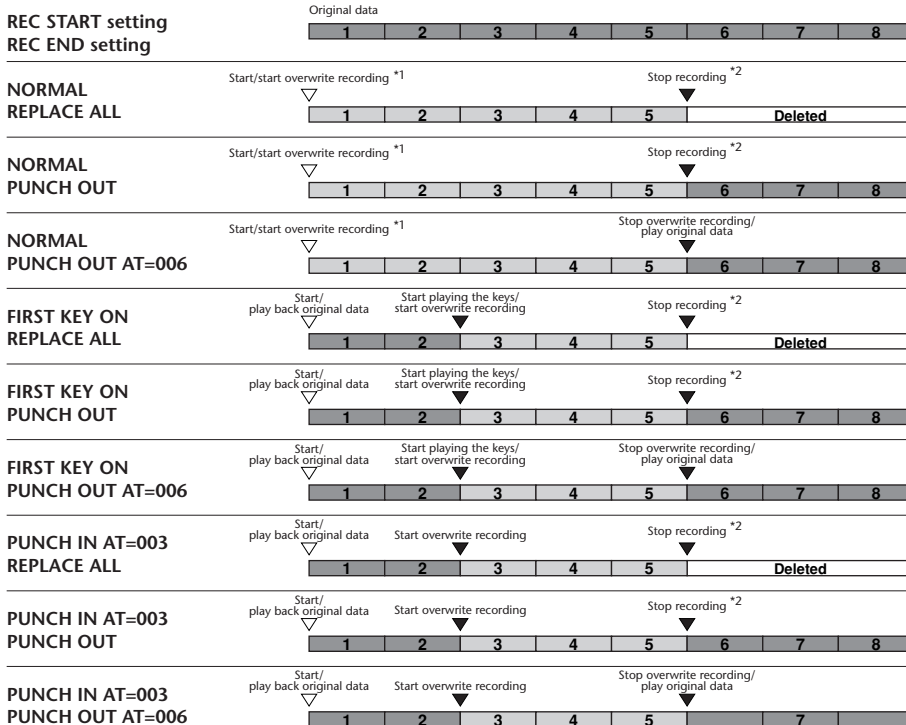

*1 When measures 1 - 2 are not overwritten, recording starts from measure 3.

*2 You'll have to press the [REC] button at the end of 5 measures.

Legend:
 [Shaded Box] Previously recorded data
 [White Box] Newly recorded data
 [Grey Box] Deleted data

Editing a Recorded Song

Whether you've recorded a song using Quick Recording, Multi Recording, or Step Recording, you can use the editing features to change the song data.

Editing Channel-related Parameters — Channel

Calling up the operations here apply to step 4 on page 94. To call up the display shown below, use the [BACK]/[NEXT] buttons.

Quantize

Quantize lets you “clean up” or tighten the timing of a previously recorded channel. For example, the following musical passage has been written with exact quarter-note and eighth-note values.



Even though you think you may have recorded the passage accurately, your actual performance may be slightly ahead of or behind the beat. Quantize allows you to align all the notes in a channel so that the timing is absolutely accurate to the specified note value (see below).

Use this to select the desired edit operation.

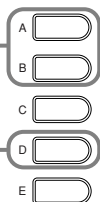

Executes the Quantize operation. After the operation is completed, this button changes to [UNDO], letting you restore the original data if you're not satisfied with the Quantize results. The Undo function only has one level; only the previous operation can be undone.

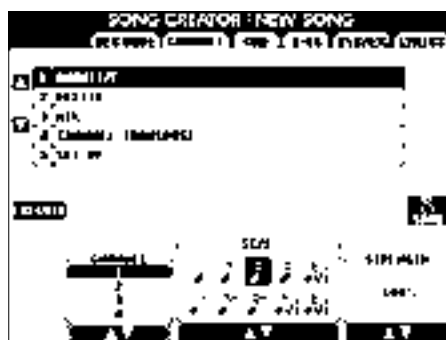

Calls up the **SONG** display, from which you can save the edited data.

Determines how strongly the notes will be quantized. If a value less than 100% is selected, notes will be moved toward the specified quantization beats only by the specified amount. Applying less than 100% quantization lets you preserve some of the “human” feel in the recording.

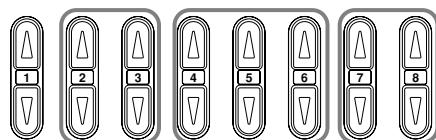

Selects the desired channel to be quantized.

Selects the quantize size (resolution). See the below for the details.

■ About Quantize Size

Set the Quantize size to correspond to the smallest notes in the channel you are working with. For example, if the data was recorded with both quarter notes and eighth notes, use 1/8 note for the Quantize size. If you apply a 1/4 note Quantize size, the eighth notes would be moved on top of the quarter notes.

One measure of eighth notes before quantization



After 1/8 note quantization



Quantize Size

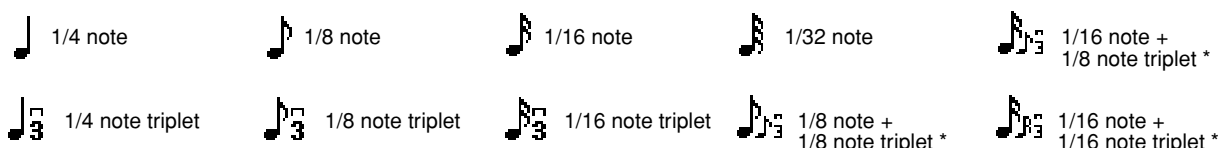

The three Quantize settings marked with asterisks (*) are exceptionally convenient, since they allow you to quantize two different note values at the same time, without compromising the quantization of either one. For example, if you have both straight 1/8 notes and 1/8 note triplets recorded to the same channel, and you quantize to straight 1/8 notes, all notes in the channel are quantized to straight 1/8 notes — completely eliminating any triplet feel in the rhythm. However, if you use the 1/8 note + 1/8 note triplet setting, both the straight and triplet notes will be quantized correctly.

Delete

This lets you delete recorded data in the specified channel.

Use these to select the desired edit operation.

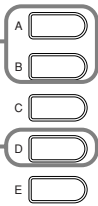

Deletes all data in the selected channel. After the operation is completed, this button changes to **[UNDO]**, letting you restore the original data. The Undo function only has one level; only the previous operation can be undone.

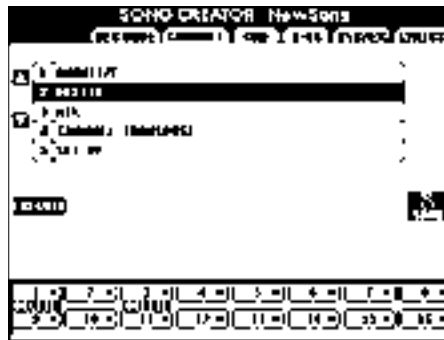

Calls up the **SONG** display, from which you can save the edited data.

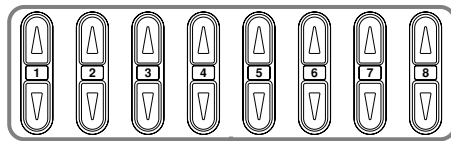

These select the channel to be deleted.

Mix

This function lets you mix the data of two channels and place the results in a different channel. It also lets you copy the data from one channel to another.

Use these to select the desired edit operation.

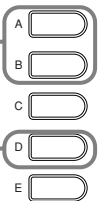

Executes the Mix operation. After the operation is completed, this button changes to **[UNDO]**, letting you restore the original data if you're not satisfied with the Mix results. The Undo function only has one level; only the previous operation can be undone.

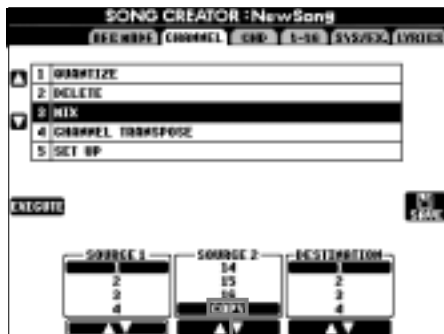

NOTE

All data other than the mixed note data is derived from the Source 1 channel.



Calls up the **SONG** display, from which you can save the edited data.

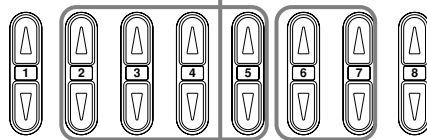

These let you specify the two source channels to be mixed.

Determines the channel into which the mix or copy results will be placed.

If "COPY" is selected here, the data from Source 1 is copied to the Destination channel.

Channel Transpose

This allows you to transpose the recorded data of individual channels up or down by a maximum of two octaves in semitone increments.

Use these to select the desired edit operation.

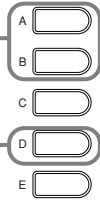

Executes the Channel Transpose operation. After the operation is completed, this button changes to [UNDO], letting you restore the original data if you're not satisfied with the Channel Transpose results. The Undo function only has one level; only the previous operation can be undone.

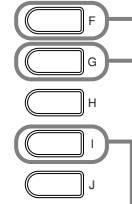
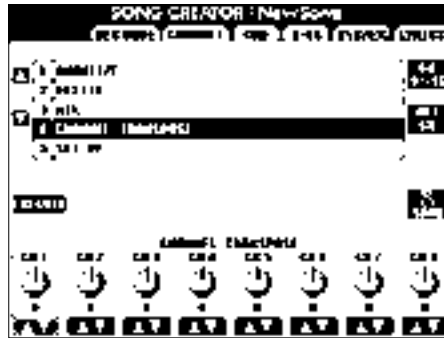

Toggles between the two channel displays: Channels 1 - 8, and Channels 9 - 16.

To simultaneously set all channels to the same value, adjust the Channel Transpose for one of the channels while holding down this button.

Calls up the SONG display, from which you can save the edited data.

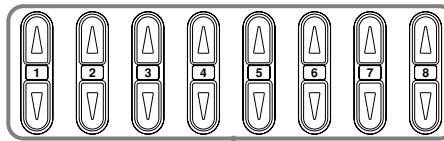

Determines the amount of transpose for each channel.

Set Up

You can change the initial settings of the song — such as voice, level, and tempo — to the current settings of the mixing console or panel controls.

Use these to select the desired edit operation.

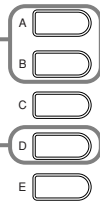

Executes the SET UP operation. Once SET UP has been executed, the operation cannot be cancelled or undone.

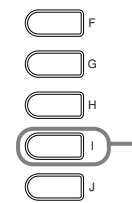
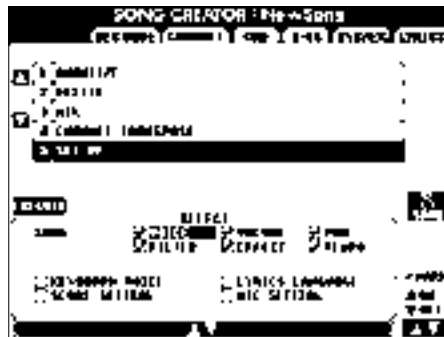

Calls up the SONG display, from which you can save the edited data.

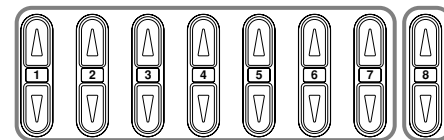

Use this to checkmark the selected item. Checkmarked items are stored with the song.

Determines which playback features and functions will be automatically called up along with the selected song. All events, with the exception of "KEYBOARD VOICE," can be recorded only at the beginning of the song. Before you select or checkmark any of these items (other than Keyboard Voice), make sure to return the song to the beginning by using the [TOP] button, and stop playback.

- Song** Stores the tempo setting and all settings made from the Mixing Console.
- Keyboard Voice** This lets you automatically set the voice of the keyboard-played parts (Main/Layer/Left) when playing back the song. Stores the keyboard-played voice and the part ON/OFF settings. To record a voice change for the keyboard-played part in the middle of a song, stop the song at the desired point, make the voice change, and press the [D] (EXECUTE) button.
- Lyrics Language** Stores the settings of the Lyrics display.
- Score Setting** Stores the settings of the Score display.
- Mic. Setting** Stores the microphone settings in the mixing console.

Editing Note Events — 1 - 16

From this display, you can edit individual note events (see below). Calling up operations here apply to step 4 on page 94. Use the [BACK]/[NEXT] buttons to call up the display below.

Use these to move the cursor up/down and select the desired event.

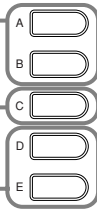

Returns to the beginning position of the current song (the first note of the first measure).

Use these to move the cursor left/right and select the desired parameter of the highlighted event. Keep in mind that moving the cursor away from the just-edited value automatically enters that value.

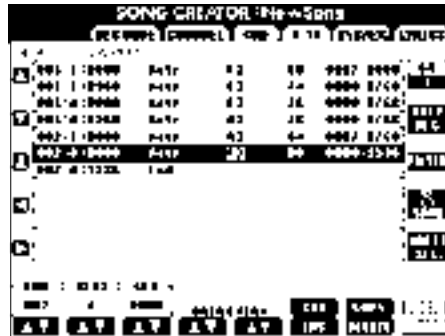

Determines the current position of the event being edited.

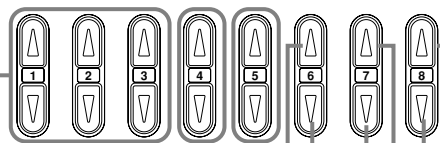

For coarse adjustment of the event value.

For fine adjustment of the event value.

Cuts (deletes) all selected events. The cut events are copied and can be pasted to another location.

Adds a new event to the Event List.

Deletes the event at the cursor position.

Determines the channel to be edited.



Calls up the **Step Recording** display (page 95).

Calls up the **Filter** display (page 105), letting you select only the events you wish to shown in the Event List.

Calls up the **SONG** display, from which you can save the edited data.

Holding this button down while using the [A] and [B] buttons lets you select multiple events.

Pastes all cut or copied events to the selected location.

If the value at the cursor has been changed, pressing this restores the original value.

Copies all selected events. The copied events can be pasted to another location.

NOTE

To actually enter an edited value, move the cursor away from the value or press the SONG [START/STOP] button.

Note Events

Parameter	Description
Note	Determines the pitch, velocity (volume) and length of the note.
Ctrl (Control change)	Determines the control change number and value. For details on control change messages, refer to the separate Data List booklet (MIDI Data Format).
Prog (Program change)	Determines the voice (program) number. For details on program change messages and how to set them, refer to the separate Data List booklet (Voice List).
P.Bnd (Pitch bend)	Determines the pitch bend value.
A.T. (After touch)	Determines the after touch value.

NOTE

The sound of the voices recorded with Step recording may sound slightly different from the original.

Editing Chord Events — CHD

From this display, you can edit the chord events you've recorded to the song. Calling up operations here apply to step 4 on page 94. Use the [BACK]/[NEXT] buttons to call up the display below. With the exception of the [F] (EXPAND) button, the operations here are the same as those in Editing Note Events (page 103).

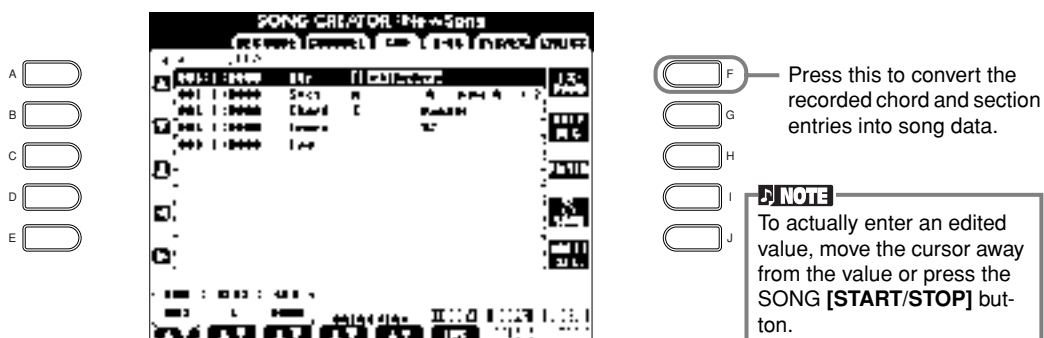

Press this to convert the recorded chord and section entries into song data.

NOTE
To actually enter an edited value, move the cursor away from the value or press the SONG [START/STOP] button.

Chord Events

Parameter	Description
Style (Accompaniment style)	Displays the accompaniment style name. To enter an accompaniment style, call up the STYLE display and select the desired style.
Tempo	Determines the tempo value.
Chord	Specifies the chord — its root note, chord type, and on-bass note.
Sect (Section)	Specifies the section — its name and variation.
OnOff (Channel on/off)	Determines whether specific channels (rhythm, bass, etc.) are turned on/off.
CH.Vol (Channel volume)	Determines the level of specific channels (rhythm, bass, etc.).
S.Vol (Style volume)	Determines the level of the entire accompaniment style.

Editing System Events — SYS/EX. (System Exclusive)

From this display, you can edit recorded System events. Calling up operations here apply to step 4 on page 94. Use the [BACK]/[NEXT] buttons to call up the display below. The operations here are the same as those in Editing Note Events (page 103).

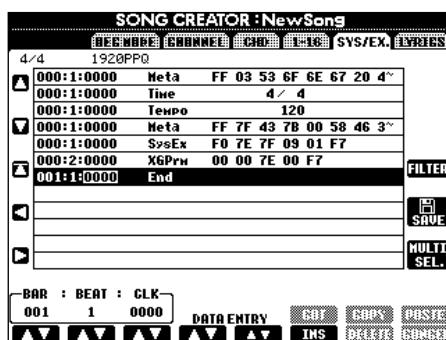

System Events

Parameter	Description
ScBar (Score initial measure)	This determines the number of the top measure. The measure number is indicated in the MAIN display or in the music notation. Only one value can be specified at the beginning of the song data.
Tempo	Determines the tempo value.
Time (Time signature)	Determines the time signature.
Key	Determines the key, as well as the major/minor setting.
XG Prm (XG parameters)	Allows you to make various detailed changes to the data. For more information on XG parameters, refer to the separate Data List booklet (MIDI Data Format).
SysEx (System Exclusive)	Displays the System Exclusive data in the song. This does not let you change the actual contents of the data; however, it lets you delete, cut, copy, and paste the data.
Meta (Meta event)	Displays the SMF meta events in the song. This does not let you change the actual contents of the data; however, it lets you delete, cut, copy, and paste the data.

Inputting and Editing Lyrics

This convenient function lets you enter the song name and the lyrics for the song. It also lets you change or correct already existing lyrics. For more information on lyric events, see the chart below. Calling up operations here apply to step 4 on page 94. Use the [BACK]/[NEXT] buttons to call up the display below. The operations here are the same as those in Editing Note Events (page 103).

In the following example, we'll rewrite a portion of the lyrics to one of the songs, "Twinkle Twinkle Little Star." Select the internal song "Twinkle Twinkle Little Star." The method for selection is the same as described on page 74.

1 Move the cursor to the event containing the lyric "star."

2 Move the cursor to the word "star."

4 Press this button to save the newly changed lyric data.

NOTE
The song "Twinkle Twinkle Little Star" is in the folder "For Children" in the Song Book (page 74).

NOTE
To actually enter an edited value, move the cursor away from the value or press the SONG [START/STOP] button.

3 Use these buttons to call up the Lyric display, from which you can input lyrics. From the Lyric display (page 45), enter the new word, "(your name)."

Lyrics Events

Parameter	Description
Name (Song name)	Determines the song name. This calls up the NAME display, from which you can enter the name.
Lyrics	Allows you to enter lyrics.
Code (Other controls)	CR : Enters a line break in the lyrics text. LF : Deletes the currently displayed lyrics and displays the next set of lyrics.

Customizing the Event List — Filter

This function lets you determine which event types will be shown in the event editing displays. To select an event for display, checkmark the box corresponding to the event name. To filter out an event so that it is not shown on the list, remove the checkmark so that the box is empty.

To call up the display below, press the [H] (FILTER) button from any of the following displays: CHD, 1 - 16, SysEX, or LYRICS (page 103 - page 105).

Calls up the Main Filter display. For more information on each event type, refer to the separate Data List booklet (MIDI Data Format).

Calls up the Control Change Filter display. For more information on each event type, refer to the separate Data List booklet (MIDI Data Format).

Calls up the Accompaniment Filter display. For more information on each event type, refer to the separate Data List booklet (MIDI Data Format).

Enters checkmarks for all items.

Selects only note data; checkmarks for all other boxes are removed.

Reverses the checkmark settings for all boxes. In other words, this enters checkmarks to all boxes that were previously unchecked and vice versa.

Selects the item, scrolling up/down one item at a time.

Enters/removes the checkmark for the selected item.

Execute the settings by pressing the [EXIT] button.

When "MAIN FILTER" or "ACCOMPANIMENT FILTER" is selected, these select the item, scrolling up/down to the top or the bottom. When "CONTROL CHANGE FILTER" is selected, these select the item, scrolling up/down eight items at a time.

Creating Accompaniment Styles — Style Creator

This powerful feature lets you create your own original styles, which can then be used for auto accompaniment — just as with the preset styles.

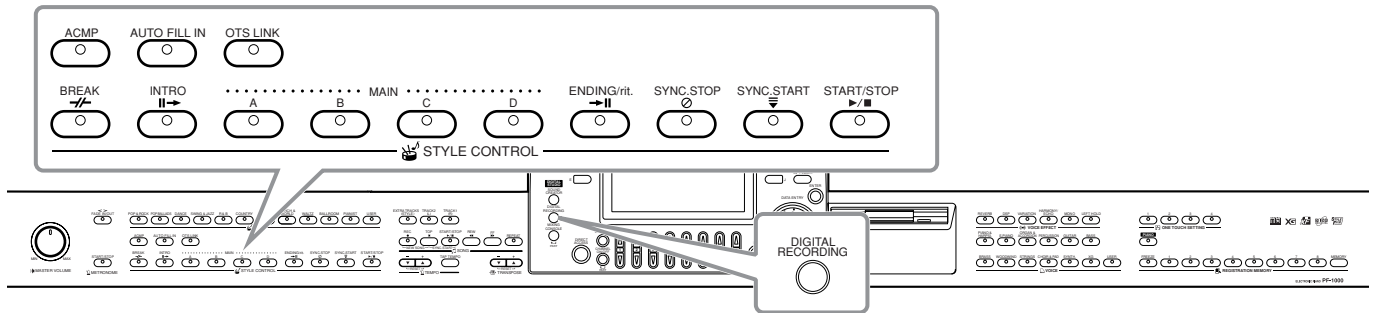

About Creating Accompaniment Styles

The chart at right shows the basic parts (or “channels”) that make up each section of an accompaniment style. To create an accompaniment style, record patterns to the various channels one by one, for each of the sections you want to create.

■ Realtime Recording (page 108)

You can record accompaniment styles by simply playing the parts from the keyboard in real time. However, you don't have to record every part yourself — you can choose an existing preset accompaniment style that is close to the style you want, then add or replace parts in that style as needed to create your own custom style.

Realtime Recording Characteristics

• Loop recording

Since auto accompaniment playback repeats the accompaniment patterns of several measures in a “loop,” you can also record patterns in a loop. For example, if you start recording with a two-measure Main section, the two measures are repeatedly recorded. Notes that you record will play back from the next loop (repetition), letting you record new material while hearing the parts you previously recorded.

• Overdub recording

This feature lets you record new material to a channel already containing recorded data, without deleting the original data. In style recording, the recorded data remains intact, unless you specifically delete it yourself. For example, if you start recording with a two-measure Main section, the two measures are repeated. As you record notes to each pass of the loop (repetition), those notes play back from the next loop, letting you overdub new material while hearing the previous parts.

■ Step Recording (page 109)

This method is like writing music notation on paper, since it allows you to enter each note or individually, and specify its length. This is ideal for making precise recordings, or for recording parts that are difficult to play.

■ Assembling an Accompaniment Style (page 110)

This convenient feature lets you create composite styles by combining various patterns from the internal preset accompaniment styles. For example, if you want to create your own original 8-beat style, you could take rhythm patterns from the “8 Beat 1” style, use the bass pattern from “8 Beat 2,” and import the chord patterns from the “60's 8 Beat” style — combining the various elements to create one accompaniment style.

■ Editing the created Accompaniment Style (page 111)

With the editing features, you can custom edit the styles you've created by real time recording, step recording, and assembling from other styles.

Section	Channel
INTRO A - D	RHYTHM 1, RHYTHM 2, BASS, CHORD 1, CHORD 2, PAD, PHRASE 1, PHRASE 2
MAIN A - D	
FILL IN A - D	
BREAK	
ENDING A - D	

NOTE
For information on the part structure of accompaniment styles, see page 92.

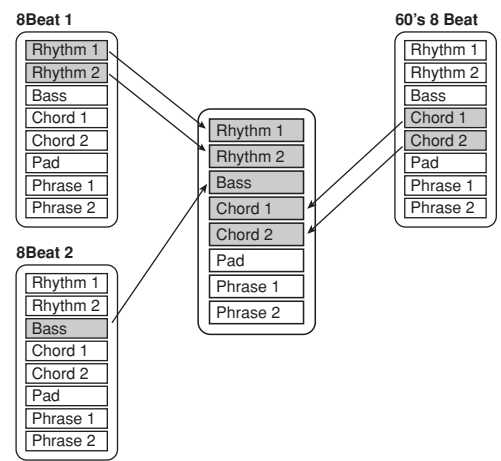

Style File Format

The Style File Format (SFF) combines all of Yamaha's auto accompaniment know-how into a single unified format. By using the edit functions, you can take full advantage of the SFF format and freely create your own styles. The chart at right indicates the process by which the accompaniment is played back. (This does not apply to the rhythm channels.) The basic or "source" pattern in the chart is the original style data. This source pattern is recorded using accompaniment style recording (see below). As shown in the chart at right, the actual output of the accompaniment is determined by various parameter settings and chord changes (played in Auto Accompaniment section of the keyboard) entered to this source pattern.

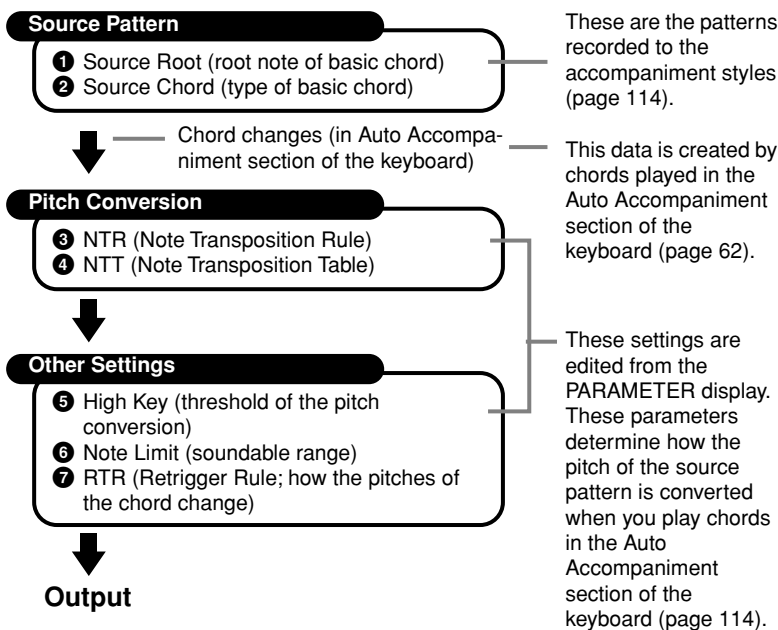

Operation

- 1 Select the desired accompaniment style for editing.** To record a new accompaniment style from scratch, call up the **BASIC** page in the **Style Creator** display and select "New Style" by pressing the **[C]** button.

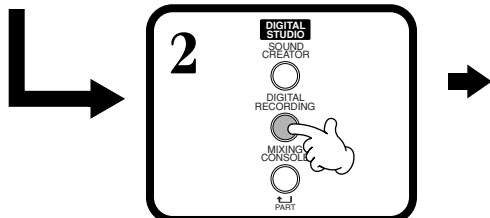

3



- 4 Record and edit the accompaniment style.** For details on the operations for each display, refer to the explanations starting on the next page.

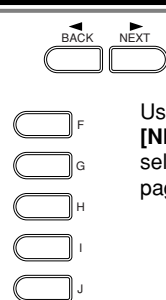

Use the **[BACK]/[NEXT]** buttons to select the various pages.

- 5 Call up the Style display by pressing the **[I]** (SAVE) button (in Assembly page: **[J]** button), then save the recorded / edited data to the **USER** or **FLOPPY DISK** page.**



Press the **[EXIT]** button to close the **STYLE CREATOR** display.

Realtime Recording — Basic

You can use the Realtime Recording features to create your own accompaniment style — either from scratch or based on the preset accompaniment data. The operations here apply to step 4 on page 107.

1 Select the desired channel for recording by simultaneously holding down the [F] (REC CH) button and pressing the appropriate [1▲▼] - [8▲▼] button.

Before recording to one of the non-rhythm channels (**BASS - PHR 2**), make sure to delete the existing data of the appropriate channel. You can make other settings (see the box “Other Parameters in the **BASIC Display**” on page 109) after closing the **REC CHANNEL** display by pressing the [EXIT] button. To call up the **REC CHANNEL** display again, press the [F] (REC CH) button.

Calls up the display for changing the tempo or beat (time signature).

Selects an empty style, allowing you to create a new style from scratch.

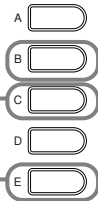

Available only when the channel is set to [RHY1] or [RHY2], this lets you delete specific percussion sounds during recording. Simultaneously hold down this button and press the key corresponding to the instrument you want to delete.

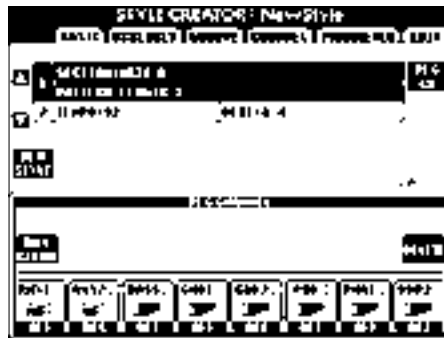

When this button is pressed, “DELETE” will appear over channels containing data. To delete data from a specific channel, simultaneously hold down this button and press the appropriate [1▲] - [8▲] button. To release or cancel the selection, press the [1▼] - [8▼] button corresponding to the channel you wish to cancel. As long as you continue to hold down the [J] button, you can toggle between deleting and restoring the selected data. Releasing the [J] button permanently deletes the data. Before recording to one of the non-rhythm channels (**BASS - PHR 2**), make sure to delete the existing data of the appropriate channel.



REC.... Channel is enabled for recording.
ON..... Channel is enabled for playback.
OFF Channel is muted.

2 First, select the desired voice. Start recording by pressing the STYLE CONTROL [START/STOP] button.

The selected section of the style starts playing back. Since the rhythm pattern loops repeatedly, you can record new sounds and notes on each pass while listening to the pattern. Icons above the keys conveniently indicate the percussion instruments assigned to the keys.

NOTE

If you've enabled Sync Start (by pressing the **SYNC. START** button), you can start recording by simply pressing a key on the keyboard.

3 Stop recording by pressing the STYLE CONTROL [START/STOP] button again.

NOTE

- Only Drum Kit/SFX Kit can be selected for the RHY 2 channel.
- For the non-rhythm channels (BASS - PHR 2), all voices with the exception of the Drum Kit/SFX Kit can be selected.



With the **REC CHANNEL** display shown, close the display by pressing the [EXIT] button.

Other Parameters in the BASIC Display

[I] (SAVE) button

Calls up the Style display for saving the accompaniment style data.

[3▲▼][4▲▼] (Section) buttons

Determines the section to be recorded.

[5▲▼][6▲▼] (Pattern Length) buttons

Determines the length of the selected section's pattern in measures (1 - 32). The Fill In/Break section is fixed at a length of one measure.

[D] (Execute) button

Executes the Pattern Length change.

NOTE

You can also select the desired section for recording by pressing the appropriate panel button. Pressing one of the Section buttons calls up the SECTION display, from which you can change sections by using the [6▲▼]/[7▲▼] buttons. To actually enter the change, press the [8▲] button. To select the **Fill In** section, press the **[AUTO FILL IN]** button.

Recording — Precautions

- The basic chord used for the accompaniment style is called the source chord. All chords that play and the pitches that sound are derived from the source chord. When recording the Main and Fill In sections (for a source chord of CM7), keep the following points in mind:

- * When recording to the Bass or Phrase channels, try to use only the recommended notes; this will ensure that you can play various chords with the accompaniment style and get optimum results. (Other notes may work, providing you use them as short passing tones.)
- * When recording to the Chord or Pad channels, use only the notes of the CM7 chord; this will ensure that you can play various chords with the accompaniment style and get optimum results. (Other notes may work, providing you use them as short passing tones.)

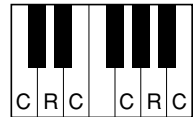

C = chord note
C, R = recommended note

The source chord is set by default to CM7; however, you can change this to any chord you prefer. Refer to the section "Making Style File Format Settings – Parameter" on page 114.

- When recording Intro and Ending sections, you can ignore the source chord and use any notes or chord progressions you like. In this case, if you set the NTR parameter to "ROOT TRANSPOSE" and NTT to "HARMONIC MINOR" or "MELODIC MINER" (in the PARAMETER page), the normal pitch conversions that would result from playing different chords are cancelled (for playback) — meaning that the accompaniment pitch conversion will only occur for changes in the root note or major/minor shifts.

Step Recording

With this method, you can create a style pattern by entering notes and other data individually, without having to perform them in real time. The operations here apply to step 4 on page 107.

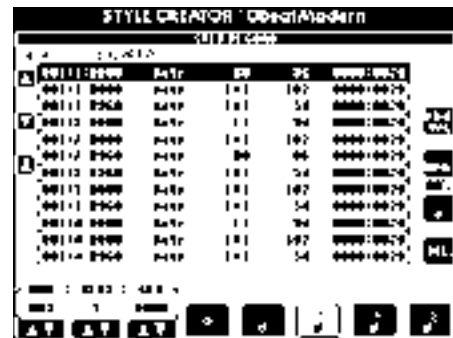
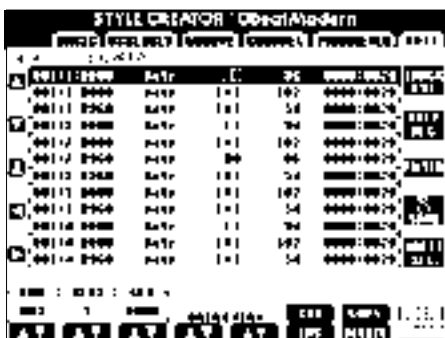

The actual recording process is the same as in Step Recording of songs (page 94), with the exception of the points described below. You can also edit each event from the Edit page, and the editing process the same as in editing songs (page 103).

- In song recording, the end mark position can be changed freely. However, it cannot be changed when creating accompaniment styles. This is because the length of the accompaniment style is automatically fixed according to the selected section. For example, when creating an accompaniment style based on a four-measure section, the end mark position is automatically set to the end of the fourth measure, and cannot be changed from the Step Record screen.
- When editing the data recorded on the Edit page, you can switch between the type of data you want to edit (event data or control data). Press the [F] (TRACK EVT) button to switch between the Event display (Note, Control Change, etc.) and the Control display (System Exclusive, etc.).

Make sure to set the record channel from another display (e.g., BASIC display; page 108) beforehand.

Assembling an Accompaniment Style — Assembly

This convenient function lets you combine accompaniment elements — such as rhythm, bass, and chord patterns — from existing styles, and use them to create your own original accompaniment styles. The operations here apply to step 4 on page 107.

1 These let you select the accompaniment style that will be used for each channel of your original style. Select the desired channel by pressing the [A] – [D], [F] – [I] buttons and press the same button to call up the **Style** screen, from which you can select the accompaniment style.

3 After repeating steps 1 and 2 as desired, press the [J] (**SAVE**) button to save the assembled style data. From here, you can store the settings of all channels (RHYTHM1, RHYTHM2, BASS, etc.) to a single accompaniment style.

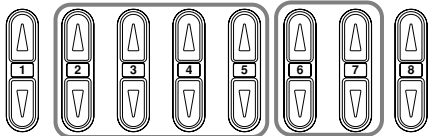

2 Selects the style section and channel that will be copied to the corresponding channels, selected with the [A]-[D] and [F]-[I] buttons above.

NOTE
If you change the section and channel in steps #1 and #2, the currently specified section and channel are also changed. The channels being recorded are also changed and recording is stopped automatically.

NOTE
The PLAY TYPE parameter affects only the playback, and does not change the actual accompaniment style data.

Determines the playback settings for each channel. You can assemble the accompaniment style while the style section and channel that will be copied are playing.

- SOLO** Mutes all but the selected channel. RHYTHM channels set to REC in the REC CHANNEL display (page 108) are played back simultaneously.
- ON** Plays back the selected channels. Any channels set to ON in the REC CHANNEL display (page 108) are played back simultaneously.
- OFF** Mutes the selected channel. If the selected channel is set to ON in the REC CHANNEL display (page 108), OFF does not appear and is not available.

Edit the Created Accompaniment Style

Change the Rhythmic Feel — Groove and Dynamics

These versatile features give you a wide variety of tools for changing the rhythmic feel of your created accompaniment style. The operations here apply to step 4 on page 107.

■ Groove

Use these to select the desired edit operation.

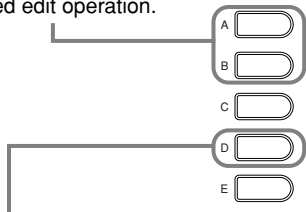

Executes the Groove operation. After the operation is completed, this button changes to [UNDO], letting you restore the original data if you're not satisfied with the Groove results. The Undo function only has one level; only the previous operation can be undone.

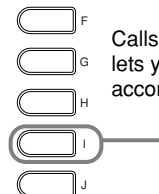

Calls up the **Style** display and lets you store the edited accompaniment style data.

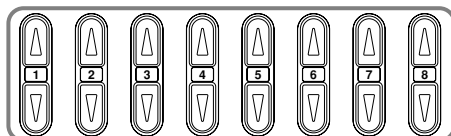

Determines the settings for each of the Groove parameters (see the list below).

Groove parameters

Original Beat	Specifies the beats to which Groove timing is to be applied. In other words, if "8 Beat" is selected, Groove timing is applied to the 8th notes; if "12 Beat" is selected, Groove timing is applied to 8th-note triplets.
Beat Converter	Actually changes the timing of the beats (specified in the ORIGINAL BEAT parameter above) to the selected value. For example, when ORIGINAL BEAT is set to "8 Beat" and BEAT CONVERTER is set to "12," all 8th notes in the section are shifted to 8th-note triplet timing. The "16A" and "16B" Beat Converter which appear when ORIGINAL BEAT is set to "12 Beat" are variations on a basic 16th-note setting.
Swing	Produces a "swing" feel by shifting the timing of the back beats, depending on the ORIGINAL BEAT parameter above. For example, if the specified ORIGINAL BEAT value is "8 Beat", the Swing parameter will selectively delay the 2nd, 4th, 6th, and 8th beats of each measure to create a swing feel. The settings "A" through "E" produce different degrees of swing, with "A" being the most subtle and "E" being the most pronounced.
Fine	Selects a variety of Groove "templates" to be applied to the selected section. The "PUSH" settings cause certain beats to be played early, while "HEAVY" settings delay the timing of certain beats. The numbered settings (2, 3, 4, 5) determine which beats are to be affected. All beats up to the specified beat—but not including the first beat—will be played early or delayed (for example, the 2nd and 3rd beats, if "3" is selected). In all cases, "A" types produce minimum effect, "B" types produce medium effect, and "C" types produce maximum effect.

■ Dynamics

Use these to select the desired edit operation.

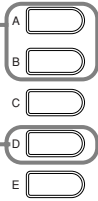

Executes the Dynamics operation. After the operation is completed, this button changes to [UNDO], letting you restore the original data if you're not satisfied with the Dynamics results. The Undo function only has one level; only the previous operation can be undone.



Calls up the **Style** display and lets you store the edited accompaniment style data.

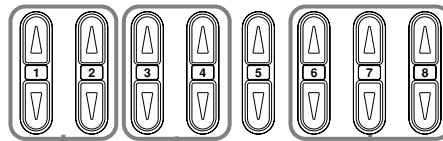

Select the desired channel to which Dynamics is to be applied.

Determines the settings for each of the Dynamics parameters (see the list below).

Dynamics parameters

Accent Type	Selects the type of accent.
Strength	Determines how strongly the selected Accent Type (above) will be applied. The higher the value, the stronger the effect.
Expand/Compress	Expands or compresses the range of velocity values, around a central velocity value "64." Values higher than 100% expand the dynamic range, while values lower than 100% compress it.
Boost/Cut	Boosts or cuts all velocity values in the selected section/channel. Values above 100% boost the overall velocity, while values below 100% reduce it.

NOTE
Velocity is determined by how strongly you play the keyboard. The more strongly you play the keyboard, the higher the velocity value and, hence, the louder the sound.

Editing the Channel Data

In this display, there are five different channel-related edit functions, including Quantize, for editing the recorded accompaniment style data. The operations here apply to step 4 on page 107.

See the explanations below.

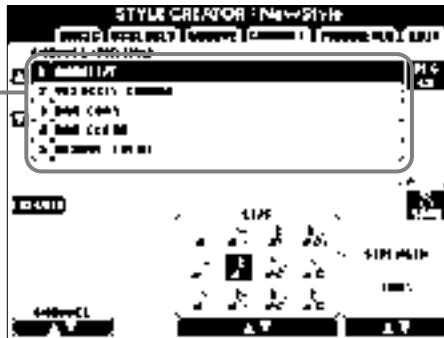

NOTE

Preset channel BASS-PHRASE2 can not be edited.

■ **Quantize**

Refer to page 100.

■ **Velocity Change**

Boosts or cuts the velocity of all notes in the specified channel (selected with the [1▲▼]/[2▲▼] (CHANNEL) buttons), according to the specified percentage (selected with the [4▲▼]/[5▲▼] (BOOST/CUT) buttons).

■ **Bar Copy**

This function allows data to be copied from one measure or group of measures to another location within the specified channel. Use the [4▲▼] (TOP) and [5▲▼] (LAST) buttons to specify the first and last measures in the region to be copied. Use the [6▲▼] (DEST) button to specify the first measure of the destination location, to which the data is to be copied.

■ **Bar Clear**

This function clears all data from the specified range of measures within the selected channel. Use the [4▲▼] (TOP) and [5▲▼] (LAST) buttons to specify the first and last measures in the region to be cleared.

■ **Remove Event**

This function lets you remove specific events from the selected channel. Use the [4▲▼] - [6▲▼] (EVENT) buttons to select the desired event type to be removed.

Making Style File Format Settings —Parameter

This display provides a variety of style controls— such as determining how the pitch and sound of the recorded style change when playing the chords in the left-hand range of the keyboard. For details about the relationship between the parameters, refer to “Style File Format” on page 107. The operations here are the same as described in step 4 on page 107.

See the explanations below.



NOTE

When NTR is set to “Root Fixed” and NTT is set to “Bypass,” the “Source Root” and “Source Chord” parameters are changed to “Play Root” and “Play Chord,” respectively. In this case, you can change chords and hear the resulting sound for all channels.

■ Source Root/Chord

These settings determine the original key of the source pattern (i.e., the key used when recording the pattern). The default setting of CM7 (with a Source Root of “C” and a Source Type of “M7”), is automatically selected whenever the preset data is deleted prior to recording a new style, regardless of the Source Root and Chord included in the preset data. When you change Source Root / Chord from the default CM7 to another chord, the chord notes and recommended notes will also change, depending on the newly selected chord type. For details on chord notes and recommended notes, see page 109.

When the Source Root is C:

CMaj C R C C R	C6 C R C C C R	CM7 C R C C R C	CM7¹¹ C R C C R C	C9 C C C C R	CM7⁹ C C C C R C	C6⁹ C C C C C R
Caug C R C R C R	Cm C R R C	Cm6 C R R C C	Cm7 C R R C C	Cm7⁵ C R C R C C	Cm⁹ C C R C	Cm7⁹ C C R C C
CM7¹¹ C R C C C	CmM7 C R R C C	CmM7⁹ C C R C C	Cdim C R C R	Cdim7 C R R C R	C7 C C C C C	C7sus4 C C C C C
C7⁵ C R C C C	C7⁹ C C C C C	C7¹¹ C R C C R	C7¹³ C R C C C	C7⁹ C C C C C	C7¹³ C C R C C	C7⁹ C C R C C
CM7aug C R C R R C	C7aug C R C R C C	C1+8 C C	C1+5 C C C	Csus4 C R C C	Csus2 C C R C R	

C = chord note
C, R = recommended note

■ NTR (Note Transposition Rule) and NTT (Note Transposition Table)

• NTR (Note Transposition Rule)

This determines the system for pitch conversion of the source pattern. Two settings are available.

Root Trans (Root Transpose)

When the root note is transposed, the pitch relationship between notes is maintained. For example, the notes C3, E3 and G3 in the key of C become F3, A3 and C4 when they are transposed to F. Use this setting for channels that contain melody lines.



Root Fixed

The note is kept as close as possible to the previous note range. For example, the notes C3, E3 and G3 in the key of C become C3, F3 and A3 when they are transposed to F. Use this setting for channels that contain chord parts.



• **NTT (Note Transposition Table)**

This sets the note transposition table for the source pattern. Six transposition types are available.

Bypass

No transposition.

Melody

Suitable for melody line transposition. Use this for melody channels such as **Phrase 1** and **Phrase 2**.

Chord

Suitable for chord transposition. Use for the **Chord 1** and **Chord 2** channels, especially when they contain piano or guitar-like chordal parts.

Bass

Suitable for bass line transposition. This table is basically similar to the Melody table above, but recognizes on-bass chords allowed in the **FINGERED ON BASS** fingering mode. Use this primarily for bass lines.

Melodic Minor

When the played chord changes from a major to a minor chord, this table lowers the third interval in the scale by a semitone. When the chord changes from a minor to a major chord, the minor third interval is raised by a semitone. Other notes are not changed.

Harmonic Minor

When the played chord changes from a major to a minor chord, this table lowers the third and sixth intervals in the scale by a semitone. When the chord changes from a minor to a major chord, the minor third and flatted sixth intervals are raised by a semitone. Other notes are not changed.

■ **High Key/Note Limit**

• **High Key**

This sets the highest key (upper octave limit) of the note transposition for the chord root change. Any notes calculated to be higher than the highest key are transposed down to the octave just below the highest key. This setting is effective only when the NTR parameter (page 114) is set to "Root Trans."

Example — When the highest key is F

Root changes → CM C#M . . . FM F#M . . .
 Notes played → C3-E3-G3 C#3-F3-G#3 F3-A3-C4 F#2-A#2-C#3



• **Note Limit**

This sets the note range (highest and lowest notes) for voices recorded to the style channels. By judicious setting of this range, you can ensure that the voices sound as realistic as possible — in other words, that no notes outside the natural range are sounded (e.g., high bass sounds or low piccolo sound). The actual notes that sound are automatically shifted to the set range.

Example — When the lowest note is C3 and the highest is D4

Root changes → CM C#M . . . FM . . .
 Notes played → E3-G3-C4 F3-G#3-C#4 F3-A3-C4



■ **RTR (Retrigger Rule)**

These settings determine whether notes stop sounding or not and how they change pitch in response to chord changes.

Stop

The notes stop sounding.

Pitch Shift

The pitch of the note will bend without a new attack to match the type of the new chord.

Pitch Shift to Root

The pitch of the note will bend without a new attack to match the root of the new chord.

Retrigger

The note is retriggered with a new attack at a new pitch corresponding to the next chord.

Retrigger To Root

The note is retriggered with a new attack at the root note of the next chord. However, the octave of the new note remains the same.

Adjust the Volume Balance and Changing Voices — Mixing Console

Set up just like a real mixing console, this display gives you comprehensive control over the sound.

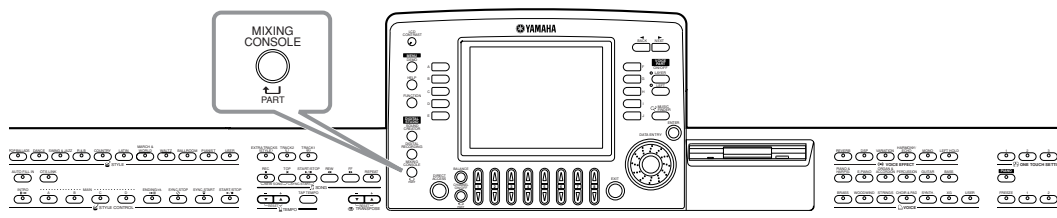

NOTE

Mixing Console

This set of controls lets you adjust the balance of the voices and their stereo position, as well as the amount of effect that is applied to each voice.

You can call up additional basic mixing controls by using the **[BALANCE]** button and the **[CHANNEL ON/OFF]** button (page 61).

Operation

1



From the **MIXING CONSOLE** display, press the button repeatedly until the desired display is called up. Each press of the button switches among the displays listed below.

PANEL PART

Includes the keyboard-played parts (Main/Layer, Left), accompaniment parts, song, microphone input

STYLE PART

Accompaniment parts

SONG CH 1 - 8

Channels 1 - 8 of song playback

SONG CH 9 -16

Channels 9 - 16 of song playback

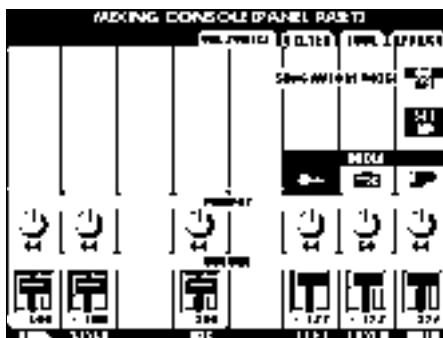

NOTE

You can quickly and easily set all parts to the same value for the same parameter (except for the **VOICE** parameter). Simultaneously hold down the **[A]** - **[J]** button that corresponds to the parameter you want to change and use the **[1]** - **[8]** buttons or the **[DATA ENTRY]** dial to change the value.

NOTE

For details on parameters related to the **Sound Creator**, see page 86.

2

Select the other Mixing Console pages by using the **[BACK]/[NEXT]** buttons and set the desired parameters.

For information on the various parameters and settings and how to use them, refer to the explanations starting on page 117.



Close the **Mixing Console** display by pressing the **[EXIT]** button.

About the parameters

• VOL/VOICE (Volume/Voice) (page 117)

This contains settings related to the volume and voice of each part/channel. Here you can also enable the Auto Revoice feature — which automatically plays XG-compatible songs (page 149) with the rich and dynamic voices that are exclusive to the PF-1000. This gives you much more authentic and realistic instrument sounds for your song playback.

• FILTER (page 118)

These controls affect the tone quality of the voice, letting you add power, punch, or brightness to the sound.

• TUNE (page 118)

These give you various tuning controls.

• EFFECT (page 119)

These control the amount of effect applied to the sound.

Setting the Level Balance and Voice — Volume/Voice

The operations for this page apply to step 2 of the procedure on page 116.

1

Use these to select the **VOICE**, **PANPOT**, or **VOLUME** parameter rows.

Set this to ON to enable automatic replacement of the XG voices (in XG song data) with the special voices of the PF-1000. To use the normal XG voice set, turn this off.

Each press of this button switches among the various parts/channels.

Allows you to select the specific voice to be replaced.

These let you select the voice of each part, and adjust the panpot and volume.

VOICE Calls up the **VOICE** display, from which you can select the desired voice (page 54). When the Style/Song part is selected, User voices cannot be selected.

PANPOT Determines the stereo position of the selected voice or track. A setting of 0 pans the sound hard left, while 64 is at center, and 127 is at hard right.

VOLUME Determines the level of each channel, giving you fine control over the balance of all the parts.

NOTE
When playing GM song data, channel 10 (in the **SONG CH 9 - 16** page) can only be used for a Drum Kit voice.

NOTE
When changing the rhythm/percussion voices (drum kits, etc.) of the accompaniment style and song from the **VOICE** parameter, the detailed settings related to the drum voice are reset, and in some cases you may be unable to restore the original sound. In the case of song playback, you can restore the original sound by returning to the beginning of the song and playing back from that point. In the case of accompaniment style play, you can restore the original sound by selecting the same style again.

2

ALL REVOICE
Replaces all of the replaceable XG voices with the rich and authentic voices of the PF-1000.

PIANO REVOICE
Replaces only the piano voices.

BASIC REVOICE
Replaces only the recommended voices that are suitable for playing back the song.

ALL NO REVOICE
All the voices are returned to the original XG voices.

Executes the settings and closes the **Auto Revoice Setup** display.

Selects the XG voices to be replaced (voices usually used when playing back)

Selects the voices used to replace the XG voices (when **SONG AUTO REVOICE** is set to ON).

Closes the **Auto Revoice Setup** screen without executing the settings.

NOTE
PIANO and **BASIC** can be called up simultaneously.

NOTE
Keep in mind that using the Revoice function may result in unnatural or unexpected sound, depending on the particular song data.

Changing the Tone of the Voice — Filter

The operations for this page apply to step 2 of the procedure on page 116.

Each press of this button switches among the various parts/channels.

Switches between the **HARMONIC** and **BRIGHTNESS** parameters.

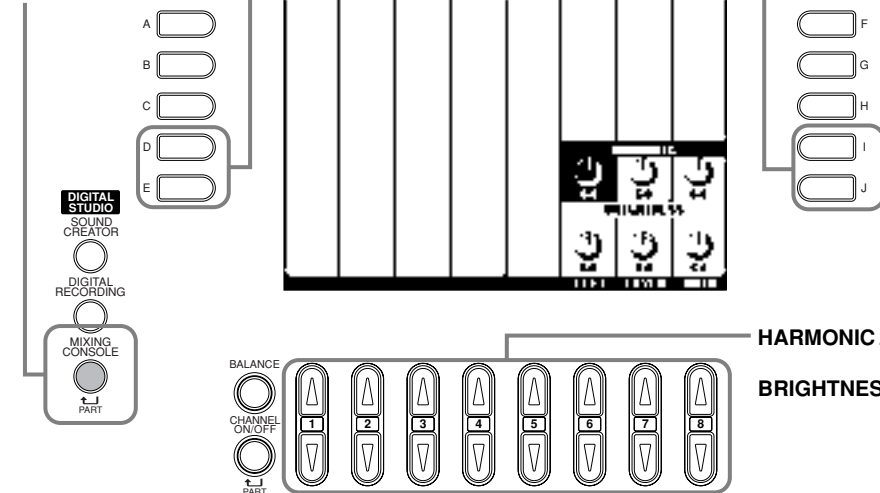

HARMONIC Allows you to adjust the resonance effect (see “Harmonic Content” on page 88).
BRIGHTNESS Determines the brightness of the sound by adjusting the cutoff frequency (page 88).

NOTE
 For details about the Filter, see page 88.

NOTE
 When a **Natural voice** is selected, **Harmonic** and **Brightness** cannot be changed.

NOTE
 Be careful with these controls. Depending on the selected voice, extreme settings may result in noise or distortion.

Changing Pitch-related Settings — Tune

The operations for this page apply to step 2 of the procedure on page 116.

Switches among the available parameters: **PORTAMENTO TIME**, **PITCH BEND RANGE**, **OCTAVE**, and **TUNING**.

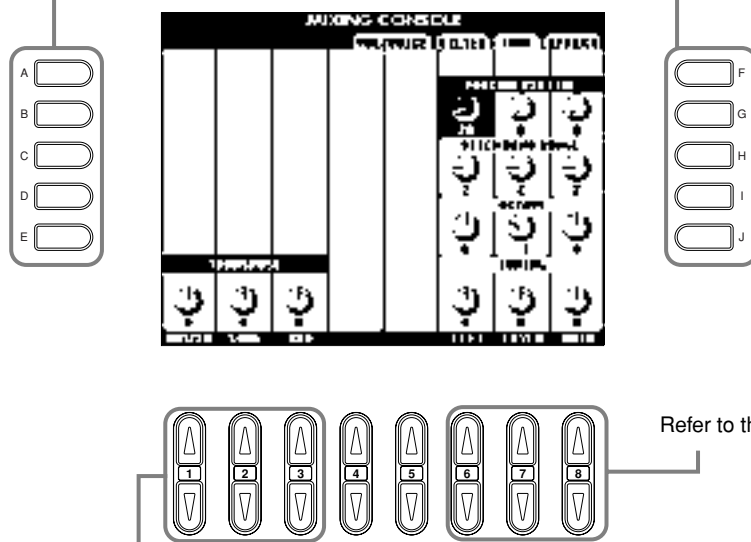

Refer to the explanation below.

These increase/decrease (transpose) the pitch in semitone units.
MASTER... Transposes both the pitch of the keyboard and that of the song playback.
SONG Transposes the pitch of the song playback.
KBD Transposes the pitch of the keyboard.

PORTAMENTO TIME When the part is set to Mono (page 58, 87), this determines the Portamento time. The higher the value, the longer the time it takes for the pitch to change. Portamento is only applied when you play legato (playing the next note before releasing the previous one).
PITCH BEND RANGE When the Pitch Bend or Glide effect is assigned to the pedal, this determines the range of the pitch change in semitones.
OCTAVE Determines the range of the pitch change in octaves, over two octaves up or down.
TUNING Determines the pitch of the instrument.

NOTE
Portamento is used to create a smooth transition in pitch from one note to the next.

NOTE
 When a **Natural voice** is selected, **Portamento Time** cannot be changed.

Adjusting the Effects

The operations for this page apply to step 2 of the procedure on page 116.

NOTE

There are three effect sections: Reverb, Chorus, and DSP (which contains a variety of effect types). These are available independently for the Natural voices and Regular voices. For details, refer to the Effect Block list (page 120).

1 Each press of this button switches among the various parts/channels.

Indicates the type name for each effect block.

Press this to edit and store the effect (page 119, 120).

Switches among the effect sections: **REVERB, CHORUS, and DSP.**

Determines the amount of effect that is applied to each part. For more information about the characteristics of each effect, see the **Effect Block** list on page 120.

2 When the **BLOCK** parameter is set to **REVERB1, CHORUS1, or DSP1**, press this to call up the display from which you can change the detailed settings for the effects.

These determine the effect block and let you assign the effect.

BLOCK..... Determines the effect block (group of similar or related effects).

PART Determines the part to which the Insertion effect is applied. It is effective only when the block is set to "DSP1" and the CONNECTION parameter is set to "Insertion" (page 120).

CATEGORY..... The various effect programs (in **Type** below) are grouped into categories. This parameter may not be available depending on the selected block.

TYPE Determines the type of effect that is assigned to the selected effect block. The actual effect types that are available may differ depending on the selected block.

3

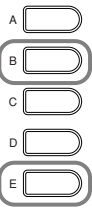

Switches between the upper/lower parameters. For the lower parameter, the depth can be changed when the [VARIATION] button is on.

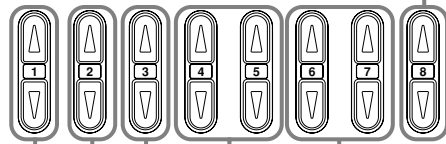

Determines the effect block.

Determines the effect category.

Determines the effect parameter to be adjusted.

Determines the effect type.



Calls up the display for storing the effect.

Determines the level of the effect (return level). This is not available when BLOCK is set to "DSP1," PARAMETER is set to "CONNECTION," and VALUE is set to "Insertion."

Determines the value of the selected parameter.

NOTE

This parameter cannot be set when BLOCK is set to "REVERB2," "CHORUS2," or "DSP2" (or "BRILLIANCE").

4



Select the destination to which the effect is to be stored. The number of memory spaces available for the destination differs for each block (refer to the chart below).

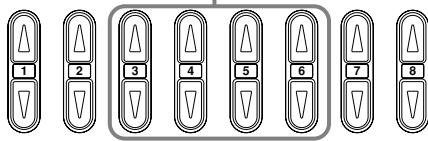

Calls up the display for naming the User Effect (page 45).

Stores the effect settings you made above to a **User Effect** location (SYSTEM) for future recall. To call up the effect, select **USER** from the **CATEGORY** parameter and select the desired effect from the **TYPE** parameter.

NOTE

Keep in mind that in some cases noise may result if you adjust the effect parameters while playing the instrument.

Effect Block

Block	Parts	Characteristics	Number of User Effect
REVERB 1 (for Regular Voices)	All parts	Reproduces the warm ambience of playing in a concert hall or jazz club.	3
REVERB 2 (for Natural Voices)	All parts except microphone (MIC)		—
CHORUS 1 (for Regular Voices)	All parts	Produces a rich "fat" sound as if several parts are being played simultaneously.	3
CHORUS 2 (for Natural Voices)	All parts except microphone (MIC)		—
DSP 1 (for Regular Voices)	Main, Layer, Left, Song (Ch. 1 - 16), MIC	In addition to reverb and chorus effects, this section features a variety of special effects, including distortion.	3
DSP 2 (for Natural Voices)	All parts except microphone (MIC)		—
BRILLIANCE (for Natural Voices)	All parts except microphone (MIC)	Changes the brightness and clarity of the sound.	—

Effect Structure

The PF-1000 features the following digital effect systems, which can be applied independently for the Natural voices (page 86) and the Regular voices (page 86). The effect type, depth, and various parameters can be set with the panel controls.

- **Reverb** Normally the settings that fit the selected style are called up. For most of the Natural voices, settings that fit the voice are called up.
- **Chorus** Normally the settings that fit the selected style are called up. For most of the Natural voices, settings that fit the voice are called up.
- **DSP** Normally the settings which fit the selected voice are called up. Variation (settings in which the expression of the effect is changed) is prepared for each type, and it can be turned ON/OFF by the [VARIATION] button on the panel.
When the Natural voice is selected, the [VARIATION] button does not work.

The illustration below shows how the various effect blocks are set up and traces the signal flow for the send/return controls set on the PF-1000.

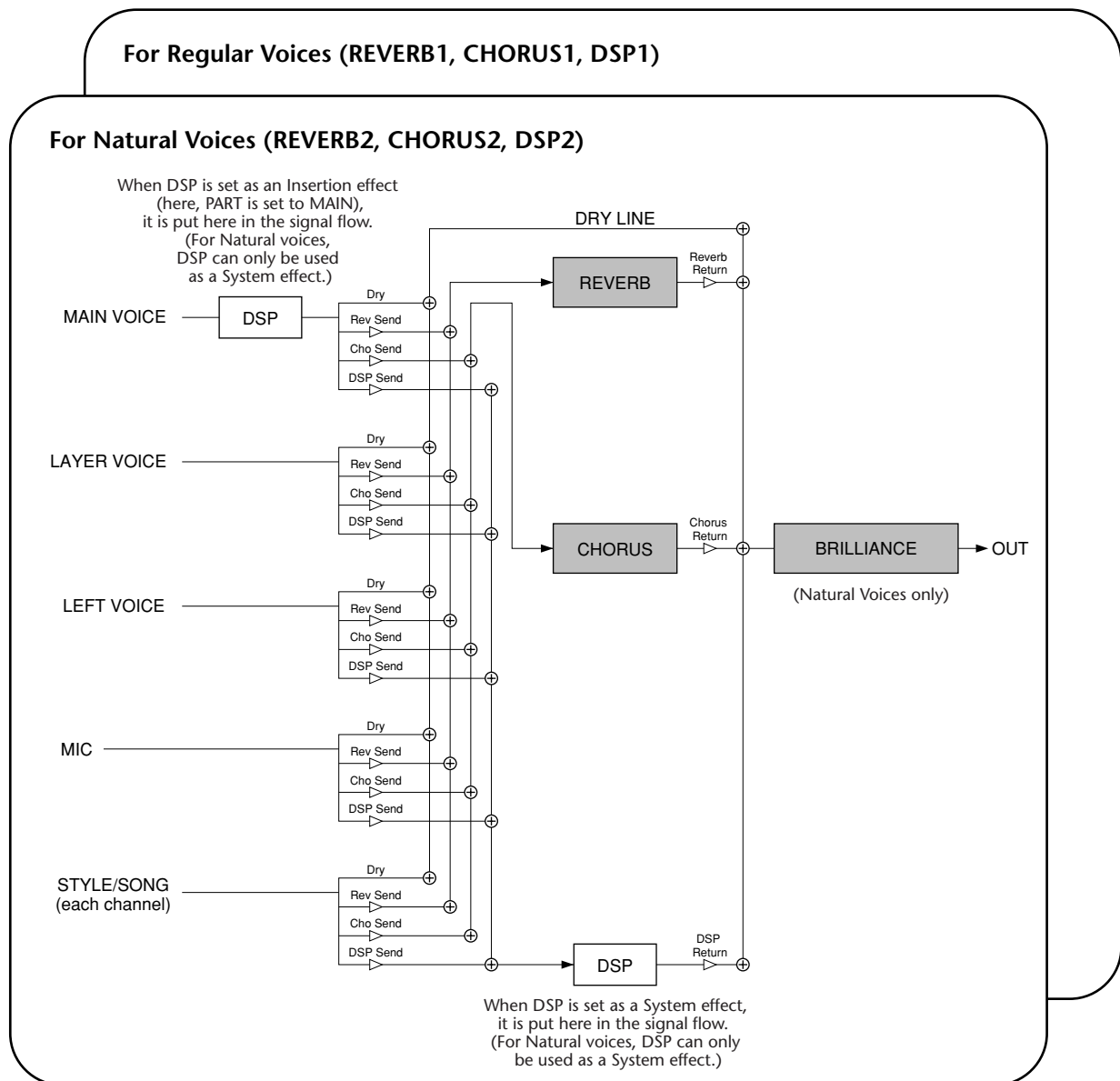

Making Global and Other Important Settings — Function

The Function mode gives you access to various advanced functions related to the instrument as a whole. These sophisticated functions let you customize the PF-1000 to your own musical needs and preferences.

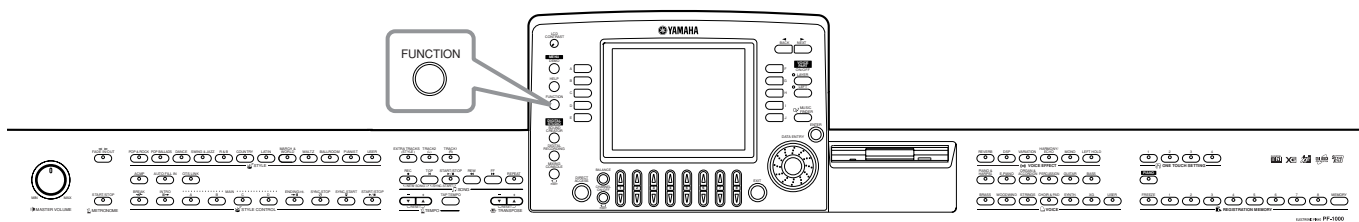

Operation

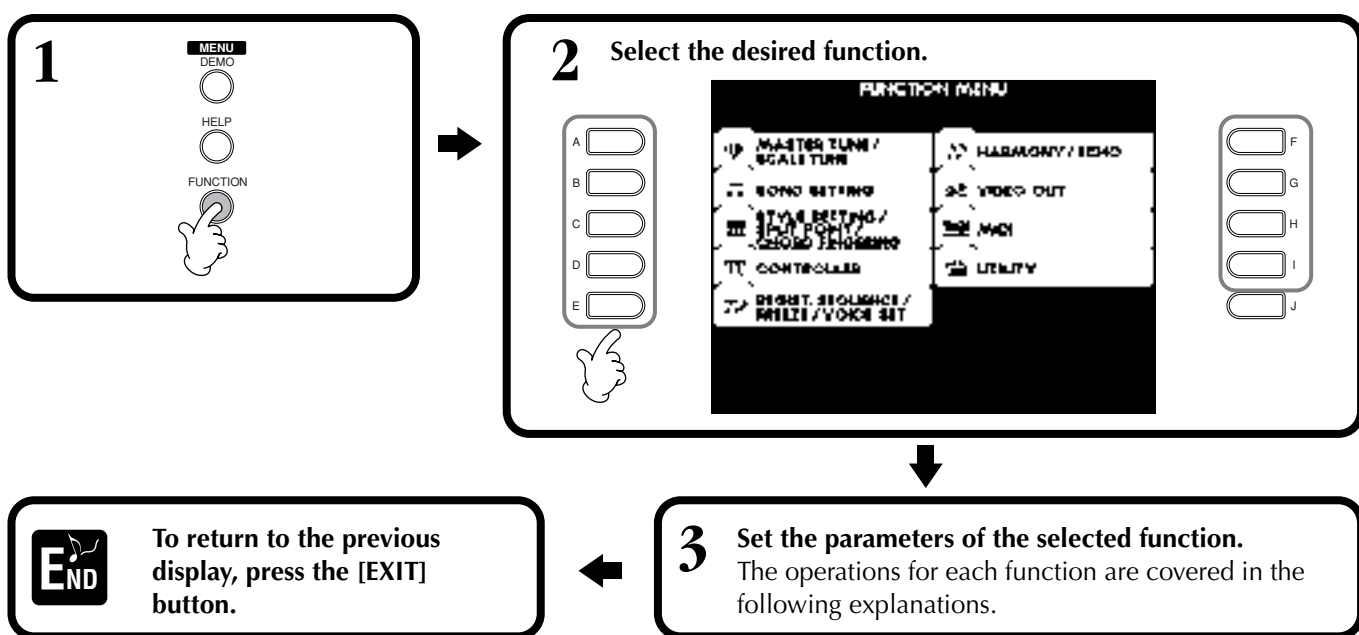

Adjusting the Pitch and Tuning — Master Tune and Scale Tune

■ Master Tune (page 124)

This allows you to make fine adjustments to the overall pitch of the instrument — letting you accurately match the tuning with that of other instruments.

■ Scale Tune (page 124)

This determines the particular tuning system (or temperament) for the instrument. This is especially useful for playing period pieces, to match the tuning system used during specific musical eras.

Setting Song-related Parameters — Song Settings (page 126)

These allow you to set parameters related to song playback.

Setting Auto Accompaniment-related Parameters — Style Setting, Split Point, and Chord Fingering

■ Style Setting / Split Point (page 127)

These determine the auto accompaniment-related settings, and let you set the split point.

■ Chord Fingering (page 128)

This determines the method for playing/indicating chords when using the auto accompaniment features. You can even check how to play the chord, since the individual notes are indicated in the display.

Making Settings for the Pedals and Keyboard — Controller

■ Pedal (page 128)

These settings determine how the connected pedals (including foot controllers and footswitches) are used. They can be assigned to a variety of functions, letting you control operations with your feet — such as turning the accompaniment style on/off, or triggering Fill In patterns.

■ Keyboard / Panel (page 130)

These settings determine the touch sensitivity of the keyboard (how touch affects volume), and let you independently transpose the keyboard, song data, and the entire instrument.

Setting the Registration Sequence, Freeze, and Voice Set

■ Registration Sequence (page 131)

This determines the order in which the Registration Memory presets (1 - 8) are called up — by using the [BACK][NEXT] buttons or the pedal.

■ Freeze (page 131)

This lets you specify the settings you want to be maintained or left unchanged, even when changing Registration Memory presets.

■ Voice Set (page 132)

This lets you determine whether certain voice-related settings (such as Effects, EQ, Harmony, etc.) are automatically called up or not when you select a voice.

Setting Harmony and Echo (page 132)

These let you set the type of Harmony or Echo effect applied to the keyboard-played voices, as well as the amount of effect.

Showing the PF-1000 Display on a TV — Video Out (page 133)

These settings determine the display characteristics when outputting the PF-1000's display contents to a TV monitor (connected to the VIDEO OUT terminal). You can set the size and color of the displayed characters, as well as the color of the display background.

Making MIDI Settings

■ System (page 134)

These determine various system messages settings (such as Clock, Start/Stop, System Exclusive), as well as Local Control on/off.

■ Transmit (page 135)

This determines how playback data is sent to connected MIDI devices — i.e., which parts are assigned to which MIDI Transmit channels. This also lets you specify the type of data to be transmitted over each channel.

■ Receive (page 136)

This determines how the parts of the PF-1000 respond to data from connected MIDI devices — i.e., which parts are assigned to which MIDI Receive channels. This also lets you specify the type of data to be received over each channel.

■ Root (page 136)

This determines the channel(s) recognized for the root notes, for use with the auto accompaniment.

■ Chord Detect (page 136)

This determines the channel(s) recognized for the chords, for use with the auto accompaniment.

Other Settings — Utility

■ Config 1 (page 137)

This page contains settings for Fade In/Out, Metronome, Parameter Lock, and the Tap sound.

■ Config 2 (page 138)

From this page, you can adjust the display, make speaker settings, and change the voice number indication.

■ Disk (page 139)

From this page, you can format disks, and copy from disk to disk.

■ Owner (page 140)

From this page, you can set the language of the instrument, and input your own name — which is shown automatically every time the power is turned on.

■ System Reset (page 140)

This function restores the PF-1000 to its original factory settings. You can also specify which types of settings are to be restored, as well as store your own original settings for future recall.

Fine Tuning the Pitch/Selecting a Scale — Master Tune/Scale Tune

The explanations here apply to step #3 of the procedure on page 122.

Tuning the Overall Pitch — Master Tune



NOTE
Hz (Hertz)
 This unit of measurement refers to the frequency of a sound, and represents the number of times a sound wave vibrates in a second.

NOTE
 The Tune function does not affect the Drum Kit or SFX Kit voices.

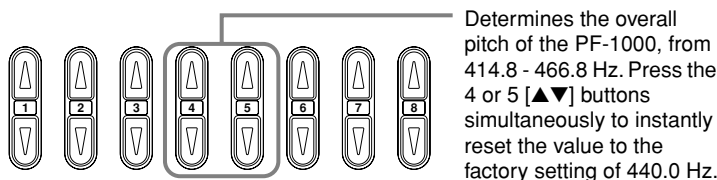

Selecting a Scale — Scale Tune

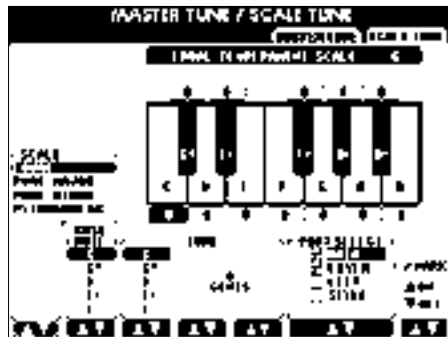

NOTE
Cent
 A unit of pitch equal to 1/100 of a semitone (100 cents = 1 semitone).

NOTE
 You can register your original scale tunings to a REGISTRATION MEMORY button. To do this, checkmark "SCALE" in the REGISTRATION MEMORY display (page 82).

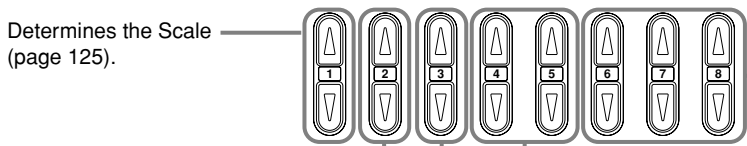

Selects which parts should be affected by the scale setting. Select the part to be set by pressing 6 or 7 [▲▼] and set the function ON or OFF by pressing [8▲▼].

Adjusts the scale tuning of the selected note.
 [4▲▼] : in 50-cent steps
 [5▲▼] : in 1-cent steps (-64 through +63)
 Press the 4 or 5 [▲▼] buttons simultaneously to instantly reset the value to the factory setting.
 When you adjust the scale tuning, the scale template name shown at the top of the display will change to "EDITED SCALE" indicating some adjustment has been done from the preset scale template.

Scale

■ Equal Temperament

The pitch range of each octave is divided equally into twelve parts, with each half-step evenly spaced in pitch. This is the most commonly used tuning in music today.

■ Pure Major/Pure Minor

These tunings preserve the pure mathematical intervals of each scale, especially for triad chords (root, third, fifth). You can hear this best in actual vocal harmonies — such as choirs and acapella singing.

■ Pythagorean

This scale was devised by the famous Greek philosopher and is created from a series of perfect fifths, which are collapsed into a single octave. The 3rd in this tuning are slightly unstable, but the 4th and 5th are beautiful and suitable for some leads.

■ Mean-Tone

This scale was created as an improvement on the Pythagorean scale, by making the major third interval more “in tune.” It was especially popular from the 16th century to the 18th century. Handel, among others, used this scale.

■ Werckmeister/Kirnberger

This composite scale combines the Werckmeister and Kirnberger systems, which were themselves improvements on the mean-tone and Pythagorean scales. The main feature of this scale is that each key has its own unique character. The scale was used extensively during the time of Bach and Beethoven, and even now it is often used when performing period music on the harpsichord.

■ Arabic

Use these tunings when playing Arabic music.

Pitch settings for each scale (in cents; example scale of C)

The values shown in this chart are actually rounded off to the nearest whole number for use on the instrument.

	C	C [#]	D	E ^b	E	F	F [#]	G	A ^b	A	B ^b	B
Equal Temperament	0	0	0	0	0	0	0	0	0	0	0	0
Pure Major	0	-29.7	3.9	15.6	-14.1	-2.3	-9.4	2.3	-27.3	-15.6	18.0	-11.7
Pure Minor	0	33.6	3.9	15.6	-14.1	-2.3	31.3	2.3	14.1	-15.6	18.0	-11.7
Pythagorean	0	14.1	3.9	-6.3	7.8	-2.3	11.7	2.3	15.6	6.3	-3.9	10.2
Mean-Tone	0	-24.2	-7.0	10.2	-14.1	3.1	-20.3	-3.1	-27.3	-10.2	7.0	-17.2
Werckmeister	0	-10.2	-7.8	-6.3	-10.2	-2.3	-11.7	-3.9	-7.8	-11.7	-3.9	-7.8
Kirnberger	0	-10.2	-7.0	-6.3	-14.1	-2.3	-10.2	-3.1	-7.8	-10.2	-3.9	-11.7
Arabic1	0	0	-50	0	0	0	0	0	0	-50	0	0
Arabic2	0	0	0	0	-50	0	0	0	0	0	0	-50

Setting Song-related Parameters — Song Settings

The explanations here apply to step #3 of the procedure on page 122.

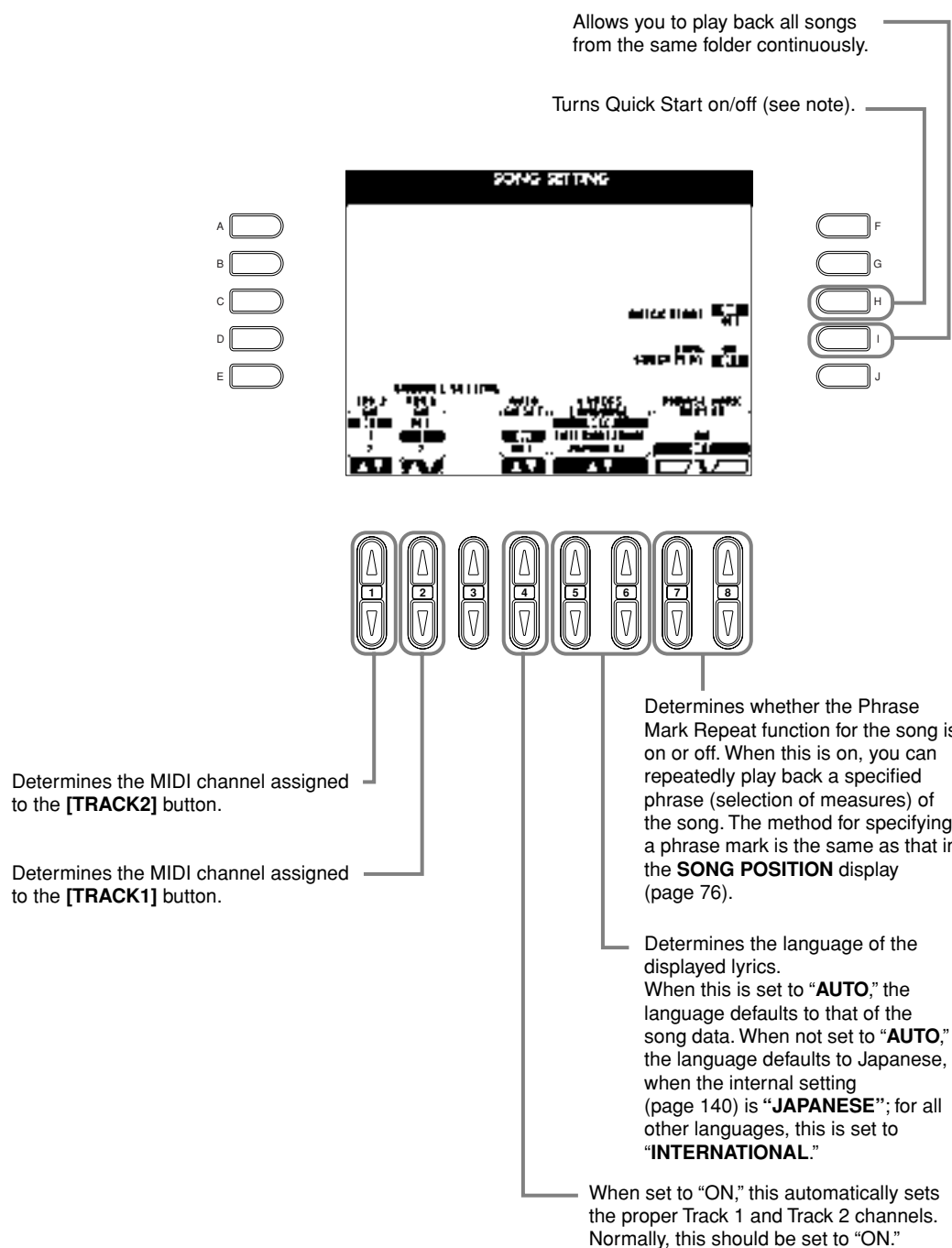

NOTE
Quick Start
 On some commercially available song data, certain settings related to the song (such as voice selection, volume, etc.) are recorded to the first measure, before the actual note data. When Quick Start is set to "ON," the PF-1000 reads all initial non-note data of the song at the highest possible speed, then automatically slows down to the appropriate tempo at the first note. This allows you to start playback as quickly as possible, with a minimum pause for reading of data.

NOTE
Channel
 Refers to the MIDI channel (page 147). The channels are assigned as follows:
Song
 1 - 16
Accompaniment Style
 9 - 16

NOTE
Phrase Mark
 This data specifies a certain location in the song data.

Setting Auto Accompaniment-related Parameters — Style Setting, Split Point, and Chord Fingering

The explanations here apply to step #3 of the procedure on page 122.

Setting Auto Accompaniment-related Parameters — Style Setting and Split Point



These select the part to which the split point setting is applied: accompaniment, left-hand range, or both. Press the desired key for the split point while holding down one of these buttons. The pressed key is included in the range for the Auto Accompaniment section of the keyboard (ACMP) or the left-hand range (LEFT).

A+L (ACMP + LEFT)

Allows you to simultaneously set the split point for both the left-hand range and the Auto Accompaniment section of the keyboard.

L (LEFT)

Allows you to set the split point for the left-hand range of the keyboard.

A (ACMP)

Allows you to set the split point for the Auto Accompaniment section of the keyboard.

NOTE

About Section Set

When any of the Main A-D sections is not included in the accompaniment style data, the nearest section is automatically selected. For example, when Main D is not contained in the selected accompaniment style, Main C will be called up.

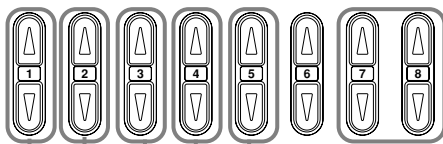

Determines the split points for the auto accompaniment (ACMP) and the left-hand range (LEFT). The same value can be set for both or for each independently, using buttons [F], [G], and [H] (see above). You can use these buttons by themselves to set the split point value.

Determines the default section that is automatically called up when selecting different accompaniment styles (when accompaniment is stopped).

Turns touch response for the accompaniment on/off. When this is set to "ON," the accompaniment volume changes in response to your playing strength (in the Auto Accompaniment section of the keyboard).

The PF-1000 lets you automatically enable Sync Stop (page 65) simply by quickly pressing/releasing keys in the Auto Accompaniment section of the keyboard. This parameter lets you set the length of the key-hold time.

This applies to the OTS Link function, in which One Touch Settings are automatically called up with changes in the section. This determines the timing in which the One Touch Settings change with the section. (The [OTS LINK] button must be on.)

Real Time

One Touch Setting is immediately called up when you press a section button.

Next Bar

One Touch Setting is called up at the next measure, after you press a section button.

NOTE

Split point can be set in the MAIN display.

Turns the Stop Accompaniment (ACMP) function on/off. When this is set to "ON," you can play the chord and bass sounds of the accompaniment by playing chords — even when the accompaniment style is not playing back.

About Split Point

Split point is the position on keyboard that separates the Auto Accompaniment section (ACMP) and left-hand section (LEFT) from the right-hand section (MAIN). The LEFT split point cannot be set lower than the ACMP split point, and the ACMP split point cannot be set higher than the LEFT split point.

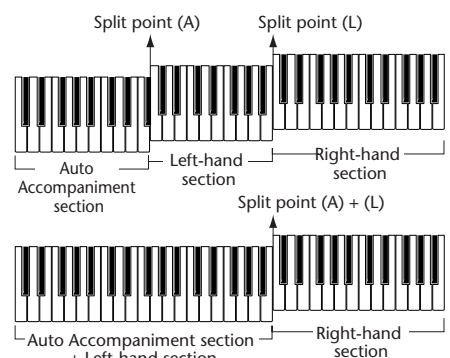

Setting the Fingering Method — Chord Fingering

This determines how the notes you play on the keyboard indicate or play the chords of the accompaniment. To learn how to play certain chords, use the convenient Chord Tutor function (see note below).

Indicates the note that belongs to a chord. Some notes can be omitted. The chord name is indicated next to "CHORD NAME."

● ... Required
○ ... Can be omitted
△ ... Either note can be omitted
▲ ... Can be omitted when the note indicated by ○ is omitted

Determines the fingering type (page 62).

Indicates the note that belongs to a chord in the music.

This lets you change the root note from the chord.

This lets you change the chord type.

NOTE
The chord indication in the display applies to the Fingering method, regardless if another method is actually selected.

NOTE
Chord Tutor
The Chord Tutor feature is essentially an electronic "chord book" that shows you appropriate fingerings for chords; it is useful when you want to play certain chords. Simply specify the desired chord via the [6▲▼] - [8▲▼] buttons, and the fingerings for the Fingering method are indicated in the display.

Making Settings for the Pedals and Keyboard — Controller

The explanations here apply to step #3 of the procedure on page 122.

Making Settings for the Pedals

Determines the particular pedal to which a function is to be assigned.

Pedal on/off operation may differ depending on the particular pedal you've connected to the [AUX PEDAL] jack. For example, pressing down on one pedal may turn the selected function on, while pressing a different make/brand of pedal may turn the function off. If necessary, use this setting to reverse the operation.

Determines the function to be assigned to the selected pedal. Any one of the available functions can be assigned to each pedal. For information on the assignable functions, see "Pedal-controllable Functions" on page 129.

If necessary, you can turn the corresponding part ON/OFF or set the control depth (see the next page).

Pedal-controllable Functions

VOLUME*	Allows you to use a foot controller (AUX pedal only) to control the volume.
SUSTAIN	When the pedal is pressed notes played have a long sustain. Releasing the pedal immediately stops (damps) any sustained notes.
SOSTENUTO	If you press and hold the pedal here, only the first note will be sustained (the note that you played and held when pressing the pedal). This makes it possible to sustain a chord, for example, while other notes are played staccato.
SOFT	Pressing the pedal subtly reduces the volume and slightly changes the timbre of notes played. It only applies to certain voices — PIANO, for example.
GLIDE	When the pedal is pressed the pitch changes, and then back to normal pitch when the pedal is released.
PORTAMENTO	The portamento effect (a smooth slide between notes) can be produced while the pedal is pressed. Portamento is produced when notes are played legato style (i.e., a note is played while the preceding note is still held). The portamento time can be set via the Mixing Console display (page 118). It does not work for Natural voices.
PITCHBEND*	Bend notes up or down while pedal is pressed.
MODULATION*	Applies a vibrato effect to notes played on the keyboard. The depth of the effect increases while pedal is pressed. This does not work for the Natural voices.
DSP VARIATION	Same as the [VARIATION] button. This does not work for the Natural voices.
VIBROTOR ON/OFF	Turns the “VibRotor” effect type (page 119) on and off. This only works for the Natural voices.
HARMONY/ECHO	Same as the [HARMONY/ECHO] button.
SCORE PAGE+	While the song is stopped, you can turn to the previous score page (one page only).
SCORE PAGE-	While the song is stopped, you can turn to the next score page (one page only).
SONG START/STOP	Same as the SONG [START/STOP] button.
STYLE START/STOP	Same as the STYLE CONTROL [START/STOP] button.
TAP TEMPO	Same as the [TAP TEMPO] button.
SYNCO START	Same as the [SYNCO. START] button.
SYNCO STOP	Same as the [SYNCO. STOP] button.
INTRO	Same as the [INTRO] button.
MAIN A	Same as the [MAIN A] button.
MAIN B	Same as the [MAIN B] button.
MAIN C	Same as the [MAIN C] button.
MAIN D	Same as the [MAIN D] button.
FILL DOWN	A fill-in plays, automatically followed by the Main section of the button on the immediate left.
FILL SELF	Fill-in starts playing.
BREAK	Break starts playing.
FILL UP	A fill-in plays, automatically followed by the Main section of the button on the immediate right.
ENDING	Same as the [ENDING/rit.] button.
FADE IN/OUT	Same as the [FADE IN/OUT] button.
FING/ON BASS	The pedal alternately switches between the Fingered and On Bass modes (page 62).
BASS HOLD	While the pedal is pressed, the Accompaniment Style bass note will be held even if the chord is changed. If the fingering is set to “FULL KEYBOARD,” the function does not work.
PERCUSSION	The pedal plays a percussion instrument selected by the [4▲▼] - [8▲▼] buttons. You can use the keyboard to select the desired percussion instrument.
LAYER ON/OFF	Same as the [LAYER] button.
LEFT ON/OFF	Same as the [LEFT] button.
OTS+	Calls up the next One Touch Setting.
OTS-	Calls up the previous One Touch Setting.

* For best results, use the optional Yamaha FC7 Foot Controller.

The parameters below correspond to buttons **[2▲▼]** - **[8▲▼]**, and their availability depends on the selected control Type. For example, if SUSTAIN is selected as the Type, the parameters “**HALF PEDAL POINT**”, “**MAIN**”, “**LAYER**” and “**LEFT**” automatically appear in the display.

SONG, STYLE, MIC, LEFT, LAYER, MAIN	These specify the part(s) that will be affected by the pedal.
HALF PEDAL POINT*	You can specify how far down you should press on the right pedal until the damper effect (page 58) starts working.
DEPTH	Determines the depth of the left pedal effect, when SOFT is selected. This only works for the Natural voices.
UP/DOWN	When GLIDE or PITCH BEND is selected, this determines whether the pitch change goes up (is raised) or down (is lowered).
RANGE	When GLIDE or PITCH BEND is selected, this determines the range of the pitch change, in semitones.
ON SPEED	When GLIDE is selected, this determines the speed of the pitch change, when the pedal is pressed.
OFF SPEED	When GLIDE is selected, this determines the speed of the pitch change, when the pedal is released.
KIT	When PERCUSSION is assigned to the pedal, all available drum kits are shown here, letting you select the particular drum kit used for the pedal.
PERCUSSION	When PERCUSSION is assigned to the pedal, all sounds of the selected drum kit (in KIT above) are shown here. This determines the particular instrument sound assigned to the pedal.

* For best results, use the optional Yamaha FC7 Foot Controller.

Changing the Touch Sensitivity and Transpose — Keyboard/Panel

Keyboard Touch

The Touch feature lets you control the volume of the voices by your playing strength. These settings allow you to customize the keyboard's touch response (sensitivity) to your personal playing preferences.

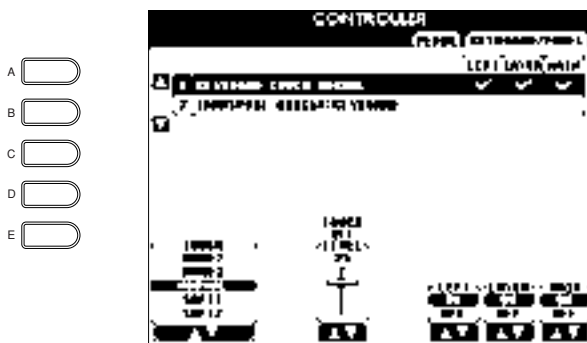

- A
- B
- C
- D
- E

HARD 2	Requires strong playing to produce high volume. Best for players with a heavy touch.
HARD 1	Requires moderately strong playing for higher volume.
NORMAL	Standard touch response.
SOFT 1	Produces high volume with moderate playing strength.
SOFT 2	Produces relatively high volume even with light playing strength. Best for players with a light touch.

Determines the fixed volume level when Touch is set to "OFF"

Determines the Touch sensitivity setting (refer to the table at right).

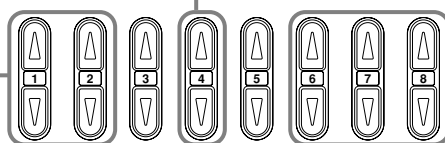

Determines whether touch is on or not for the corresponding parts.

NOTE

The TOUCH setting affects all voices globally. Keep in mind that you can set each voice to a different touch sensitivity (TOUCH SENSE). For example, to play a pipe organ voice most authentically, you can set this so that the voice is not affected by touch (page 87).

Transpose Assign

This determines which aspect of the instrument is affected by the [TRANPOSE] button.

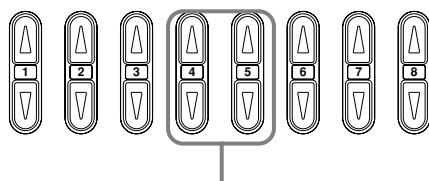

KEYBOARD

For this setting, Transpose affects the pitch of the keyboard-played voices (Main, Layer, and Left) and the accompaniment styles.

SONG

For this setting, Transpose affects only the pitch of the songs.

MASTER

For this setting, Transpose affects the pitch of the entire instrument (keyboard voices, accompaniment styles, and songs).

NOTE

The transpose function does not affect the Drum Kit or SFX Kit voices.

Transpose

Allows you to shift the pitch of the keyboard-played voices, accompaniment style playback, and song data in semitone units.

- 1 Press one of the [TRANPOSE] buttons.

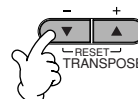

- 2 A TRANPOSE pop-up window, selected via TRANPOSE ASSIGN, appears.



- 3 Adjust the value by using the [TRANPOSE] buttons.



Close the TRANPOSE windows by pressing the [EXIT] button.

• **Selectively Transposing Keyboard/Song**

These settings can be used to match both the song and your keyboard performance to a certain key. For example, let's say you wish to play and sing along with a certain recorded song. The song data is in F, but you feel most comfortable singing in D, and you are accustomed to playing the keyboard part in C. To match up the keys, keep the Master Transpose setting at "0," set the Keyboard Transpose to "2," and set Song Transpose to "-3." This brings the keyboard part up in pitch and the song data down to your comfortable singing key.

Setting the Registration Sequence, Freeze, and Voice Set

The explanations here apply to step #3 of the procedure on page 122.

Specifying the Order for Calling Up Registration Memory Presets — Registration Sequence

You can save your custom panel settings to the Registration Memory presets, and call them up by pressing the appropriate REGISTRATION MEMORY buttons [1] - [8]. The convenient Registration Sequence function lets you call up the presets in any order you specify, by simply using the [BACK]/[NEXT] buttons or the pedal as you play.

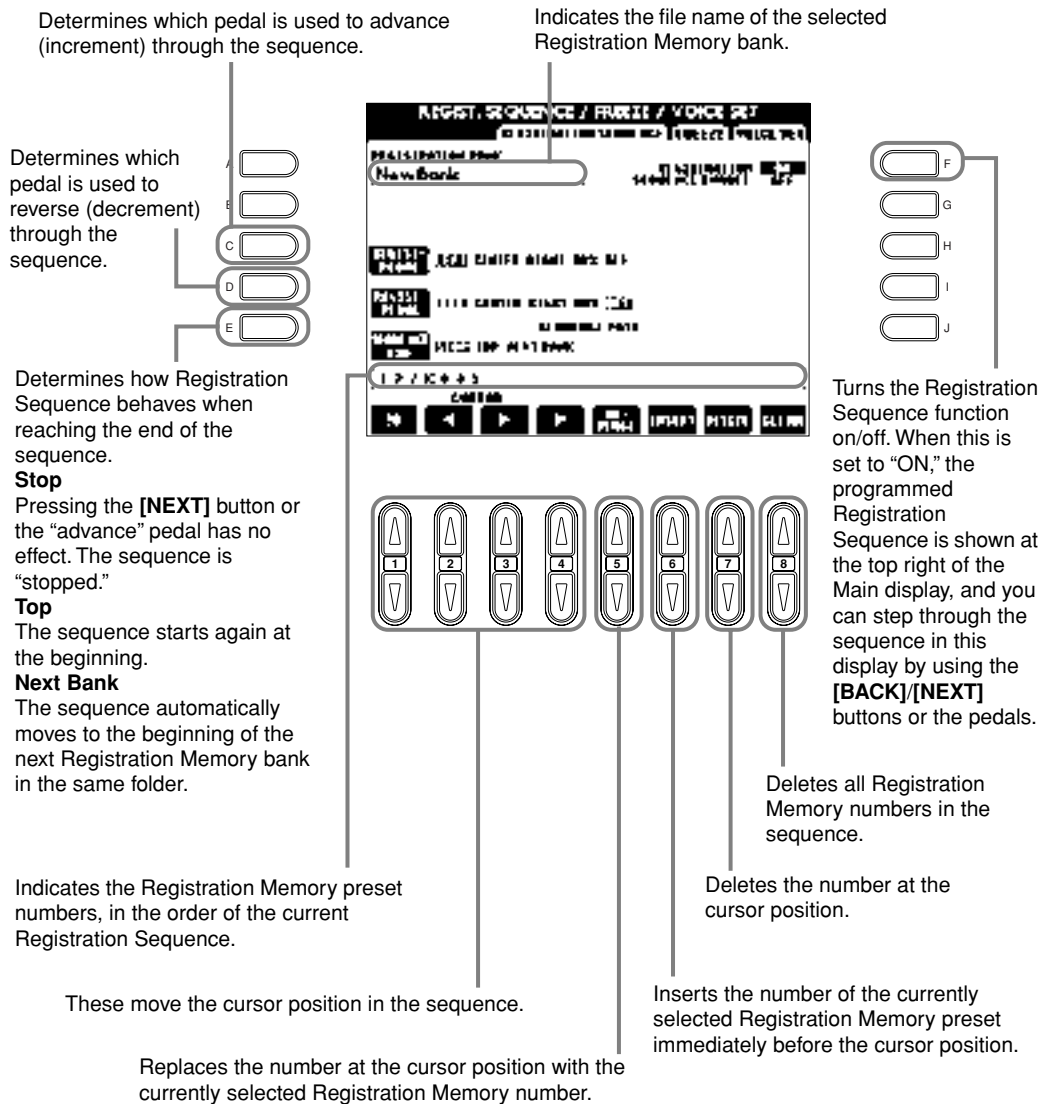

NOTE
Setting Registration Sequence Enable to "ON" overrides any other Pedal settings (for pedals assigned to "Regist (+) Pedal" and "Regist (-) Pedal" here). These include the pedal settings on page 128, and in Voice Set on page 132.

NOTE
When both "Regist (+) Pedal" and "Regist (-) Pedal" are set to "OFF," the pedals cannot be used to step through the Registration Sequence; only the [BACK]/[NEXT] buttons can be used in the MAIN display.

NOTE
When both "Regist (+) Pedal" and "Regist (-) Pedal" are set to the same pedal, "Regist (+) Pedal" takes priority.

NOTE
Registration Sequence data is included as part of the Registration Memory bank file. To save your newly programmed Registration Sequence, store the current Registration Memory bank file (page 38, 44). Any Registration Sequence data is lost when changing Registration Memory banks, unless you've stored it with the Registration Memory bank file.



Execute the settings by pressing the [EXIT] button.

Maintaining Panel Settings — Freeze

This lets you specify the settings you want to be maintained or left unchanged, even when changing Registration Memory presets. For details, see page 84.

Changing the Automatically Selected Voice Settings — Voice Set

When changing voices (selecting a voice file), the settings best matching the voice — the same as those set in the Sound Creator — are always and automatically called up. From this page, you can set the on/off status for each part. For example, each of the preset voices has its own LEFT PEDAL setting; however, even changing voices will not change the LEFT PEDAL setting, if it is set to "OFF" in this page.

Use these to select the desired part.

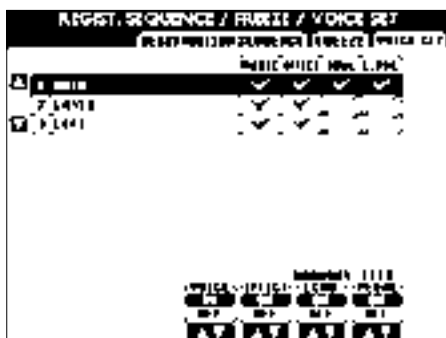
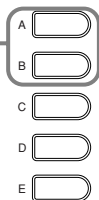

NOTE

Normally, these should all be set to "ON."

NOTE

Harmony/Echo and Left pedal assignment cannot be set for the Layer and Left parts.

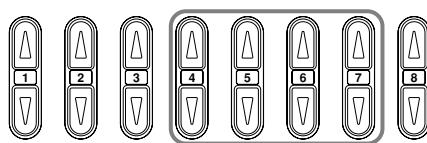

These determine whether the corresponding voice-related settings (Voice selection, Effects, Harmony/Echo, and left pedal assignment) are automatically called up or not when you select a voice. These settings can be turned on or off independently for each part.

Setting Harmony and Echo

The explanations here apply to step #3 of the procedure on page 122.



Determines the Harmony type. For details, see page 133.

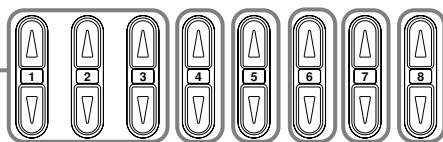

Determines the level of the Harmony effect.

Determines the speed of the Echo, Tremolo, and Trill effects. This parameter is only available when Echo, Tremolo, or Trill is selected in Type above.

Determines the lowest velocity value at which the harmony note will sound. This allows you to selectively apply the harmony by your playing strength, letting you create harmony accents in the melody. The harmony effect is applied when you play the key strongly (above the set value).

When this is set to "ON," the Harmony effect is applied only to the note that belongs to a chord played in the Auto Accompaniment section of the keyboard. This parameter is not available when Multi Assign, Echo, Tremolo, or Trill is selected in Type above.

This lets you assign the Harmony effect to various parts. For details, see page 133.

About the Harmony Types

When a normal Harmony type (“Standard Duet” through “Strum”) is selected

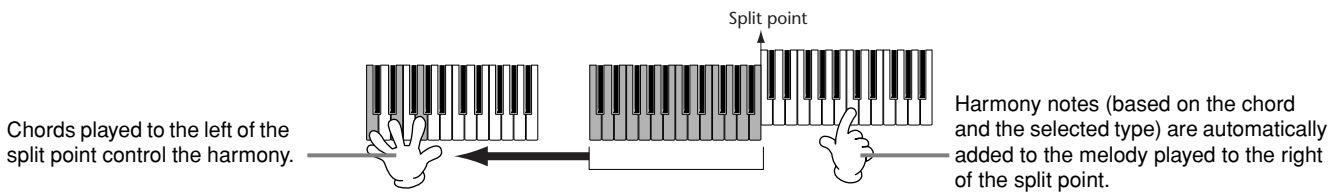

When “Multi Assign” is selected

Multi Assign automatically assigns notes played simultaneously on the right-hand section of the keyboard to separate parts (voices). For example, if you play two consecutive notes, the first is played by the Main voice and the second by the Layer voice.

When “Echo” is selected

An echo effect is applied to the note played on the keyboard, in time with the currently set tempo.

When “Tremolo” is selected

A tremolo effect is applied to the note played on the keyboard, in time with the currently set tempo.

When “Trill” is selected

Two notes held on the keyboard are played alternately, in time with the currently set tempo.

About the Harmony Assignments

Multi

This automatically assigns the 1st, 2nd, 3rd, and 4th added harmony notes to different parts (voices). For example, if the Main and Layer parts are turned on and the “Standard Duet” type is selected, the note you play on the keyboard will be played by the Main voice, and the added harmony note will be played by the Layer voice.

Main

Harmony is applied only to the Main part.

Layer

Harmony is applied only to the Layer part. When the Layer part is turned off, Harmony is not applied.

Showing the PF-1000 Display on a TV — Video Out

The explanations here apply to step #3 of the procedure on page 122.

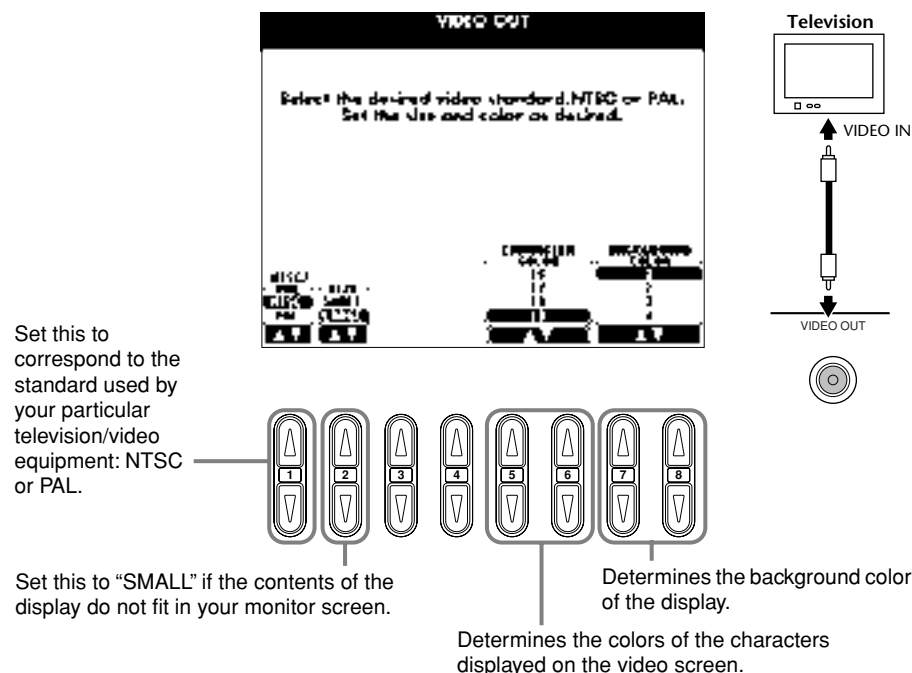

NOTE

- Occasionally some flashing parallel lines may appear in the television or video monitor. This does not necessarily indicate that the monitor is malfunctioning. You may be able to remedy the situation by changing the Character Color or Background Color parameters. For optimum results, also try adjusting the color settings on the monitor itself.
- Avoid looking at the television or video monitor for prolonged periods of time since doing so could damage your eyesight. Take frequent breaks and focus your eyes on distant objects to avoid eyestrain.
- Keep in mind that even after adjusting all settings as recommended here, the monitor you are using may not show the PF-1000’s display contents as expected (e.g., the display contents may not fit on the screen, the characters may not be completely clear, or the colors may be incorrect).

Setting the MIDI Parameters

In this section, you can make MIDI-related settings for the instrument. These settings can be stored all together from the USER display, for future recall.

For general information and details about MIDI, see “What is MIDI?” (page 145).

The explanations here apply to step #3 of the procedure on page 122.

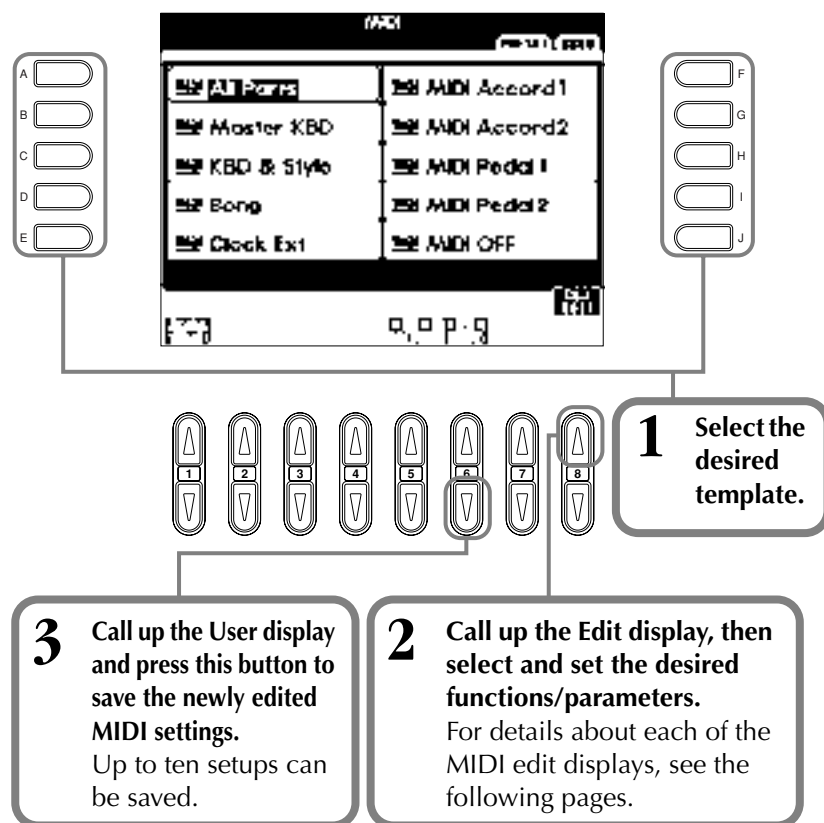

Preset MIDI Templates (Factory Set)

All Parts	Transmit all parts including Main, Layer and Left.
Master KBD	The PF-1000 functions as a master keyboard for controlling external tone generators or other devices.
KBD & Style	Transmit Upper and Lower keyboard play instead of the individual parts (Main/Layer/Left).
Song	All Transmit channels are set to correspond to the Song channels 1-16. Use this to play the PF-1000 song data with an external tone generator, or to record your entire performance to an external sequencer.
Clock Ext.	MIDI IN terminal receives MIDI clock and PF-1000 synchronizes with an external MIDI device.
MIDI Accord 1	An ideal setup for controlling the keyboard voice and accompaniment style with a MIDI accordion.
MIDI Accord 2	Chord and bass buttons on a MIDI accordion control the accompaniment style, as well as play the chord and bass parts.
MIDI Pedal 1	The MIDI pedal connected to MIDI IN terminal controls the bass note of the accompaniment.
MIDI Pedal 2	The MIDI pedal connected to MIDI IN terminal plays the bass part.
MIDI OFF	MIDI signals are neither sent nor received.



Press the [EXIT] button to return to the previous display.

NOTE

The saved settings can be named (page 41) or deleted (page 43) in the User page.

Making Overall System Settings (Local Control, Clock, etc.) — System

Call up the display as described in step 2 above.

For editing the Clock, Transmit Clock, Receive Transpose, and Start/Stop parameters.



For editing the Local Control parameters.

For editing the Message Switch parameters.

Local Control

Turns the Local Control for each part on or off. When Local Control is set to “ON,” the keyboard of the PF-1000 controls its own (local) internal tone generator, allowing the internal voices to be played directly from the keyboard. If you set Local to “OFF,” the keyboard and controllers are internally disconnected from the PF-1000’s tone generator section so that no sound is output when you play the keyboard or use the controllers. For example, this allows you to use an external MIDI sequencer to play the PF-1000’s internal voices, and use the PF-1000 keyboard to record notes to the external sequencer and/or play an external tone generator.

Clock, Transmit Clock, Receive Transpose, Start/Stop

■ Clock

Determines whether the PF-1000 is controlled by its own internal clock or a MIDI clock signal received from an external device. “INTERNAL” is the normal Clock setting when the PF-1000 is being used alone. If you are using the PF-1000 with an external sequencer, MIDI computer, or other MIDI device, and you want the PF-1000 to be synchronized to the external device, set this function to “EXTERNAL.” In the latter case, the external device must be connected to the PF-1000 MIDI IN terminal, and must be transmitting an appropriate MIDI clock signal.

■ Transmit Clock

Turns MIDI clock transmission on or off. When this is set to “OFF,” no MIDI clock or START/STOP data is transmitted.

■ Receive Transpose

When this parameter is set to “OFF,” note data received by the PF-1000 is not transposed, and when it is set to “ON,” the received note data is transposed according to the current PF-1000 keyboard transpose (page 130) setting.

■ Start/Stop

Determines whether incoming FA (start) and FC (stop) messages affect song or style playback.

NOTE

FA, FC

MIDI messages for starting/stopping the song or style. The “FA” message corresponds to start, and “FC” corresponds to stop.

Message Switch

- SYS/EX. Tx (TRANSMIT)**..... Turns MIDI transmission of MIDI system exclusive message data ON or OFF.
- SYS/EX. Rx (RECEIVE)** Turns MIDI reception of MIDI exclusive data generated by external equipment ON or OFF.
- CHORD SYS/EX. Tx (TRANSMIT)** Turns MIDI transmission of MIDI chord exclusive data (chord detect — root and type) ON or OFF.
- CHORD SYS/EX. Rx (RECEIVE)** Turns MIDI reception of MIDI chord exclusive data generated by external equipment ON or OFF.

Transmitting MIDI Data — Transmit

This determines which parts will send MIDI data and over which MIDI channel the data will be sent.

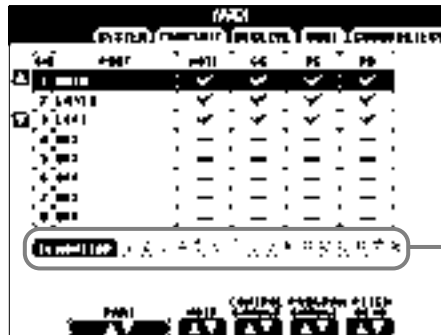
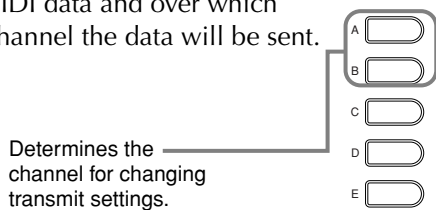

The dots corresponding to each channel (1-16) flash briefly whenever any data is transmitted on the channel(s).

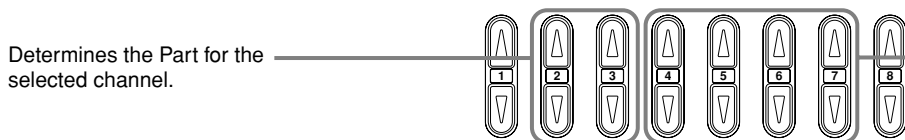

Turns transmission of the specified data type on or off. See below for details on the data types.

Data Types in the MIDI TRANSMIT/RECEIVE Display

Note	Messages which are generated when the keyboard is played. Each message includes a specific note number which corresponds to the key which is pressed, plus a velocity value based on how hard the key is played.
Control Change (CC)	Control change data includes pedal and any other controller data.
Program Change (PC)	Program change data corresponds to voice or “patch” numbers.
Pitch Bend (PB)	See page 129.
After Touch (AT)*	With this function, the PF-1000 senses how much pressure you apply to the keys while playing, and uses that pressure to affect the sound in various ways, depending on the selected voice. This allows you to play with greater expressiveness and add effects with your playing technique.

* Available in RECEIVE display only (page 136).

Receiving MIDI Data — Receive

This determines which parts will receive MIDI data and over which MIDI channel the data will be received.

Determines the channel for changing receive settings.

The dots corresponding to each channel (1 - 32) flash briefly whenever any data is received on the channel(s).

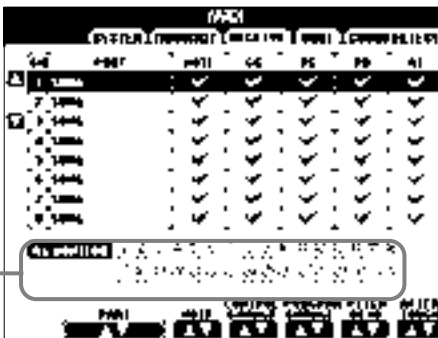
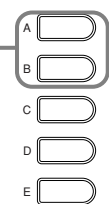

NOTE

The MIDI IN/OUT terminals and Port A of the TO HOST terminal (Port A of the CBX driver) correspond to channels 1 - 16. Port B of the TO HOST terminal (Port B of the CBX driver) corresponds to channels 17 - 32.

Determines the Part for the selected channel. See below for details about the receive parts.

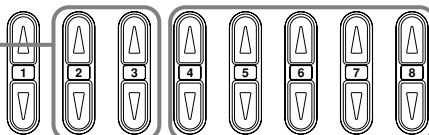

Turns reception of the specified data type on or off. See page 135 for details on the data types.

MIDI Receive Parts

OFF	No MIDI data is received.
SONG	Normally, the part receiving the MIDI data corresponds to the part/voice used in playing back the song data. Channels 1 - 16 correspond to song channels 1 - 16, respectively.
MAIN	The MAIN part is controlled by the MIDI data received on the corresponding channel.
LAYER	The LAYER part is controlled by the MIDI data received on the corresponding channel.
LEFT	The LEFT part is controlled by the MIDI data received on the corresponding channel.
KEYBOARD	MIDI note data received by the PF-1000 plays the corresponding notes in the same way as if they are played on the keyboard.
ACMP RHYTHM1-2	The received notes are used as the accompaniment RHYTHM 1 and RHYTHM 2 notes.
ACMP BASS	The received notes are used as the accompaniment BASS notes.
ACMP CHORD1-2	The received notes are used as the accompaniment CHORD 1 and CHORD 2 notes.
ACMP PAD	The received notes are used as the accompaniment PAD notes.
ACMP PHRASE1-2	The received notes are used as the accompaniment PHRASE 1 and PHRASE 2 notes.
EXTRA PART1-5	There are five parts specially reserved for receiving and playing MIDI data. Normally, these parts are not used by the instrument itself. When these five channels are enabled, you can use the instrument as a 32-channel multi-timbral tone generator.

Setting Root Note Channels — Root

The note ON/OFF messages received at the channel(s) set to “ON” are recognized as the root notes in the accompaniment section. The root notes will be detected regardless of the accompaniment ON/OFF and split point settings.

Selects the channels in groups of eight: 1 - 8, 9 - 16, 17 - 24, and 25 - 32, respectively.

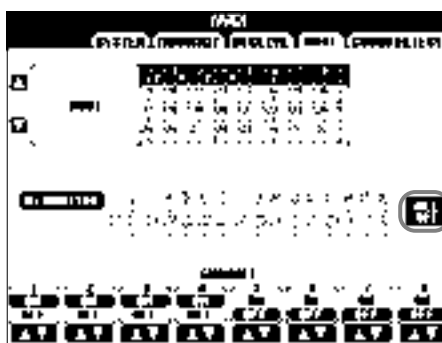
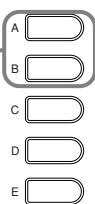

NOTE

The MIDI IN/OUT terminals and Port A of the TO HOST terminal (Port A of the CBX driver) correspond to channels 1 - 16. Port B of the TO HOST terminal (Port B of the CBX driver) corresponds to channels 17 - 32.

Sets the desired channel to ON or OFF.

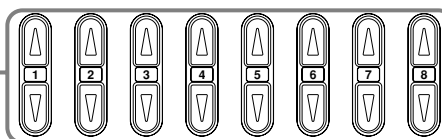

NOTE

When several channels are simultaneously set to “ON,” the root note is detected from merged MIDI data received over the channels.

Sets all channels to OFF.

Setting Chord Channels — Chord Detect

The note ON/OFF messages received at the channel(s) set to “ON” are recognized as the chord notes in the accompaniment section. The chords to be detected depend on the fingering type. The root notes will be detected regardless of the accompaniment ON/OFF and split point settings. The operation procedure is basically the same as that of the ROOT display above.

Other Settings — Utility

The explanations here apply to step #3 of the procedure on page 122.

Making Settings for Fade In/Out, Metronome, Parameter Lock, and Tap — CONFIG 1

Fade In Time, Fade Out Time, Fade Out Hold Time

These determine how long it takes for the accompaniment style and song to fade in or fade out.



Determines the time the volume is held at 0 following the fade out (range of 0 - 5.0 seconds).

Determines the time it takes for the volume to fade in, or go from minimum to maximum (range of 0 - 20.0 seconds).

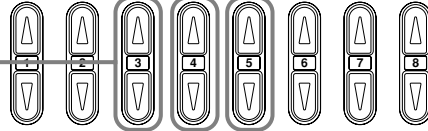

Determines the time it takes for the volume to fade out, or go from maximum to minimum (range of 0 - 20.0 seconds).

Metronome

These let you make settings for the metronome-related parameters.



Determines the level of the metronome sound.

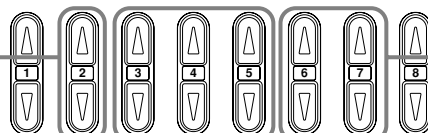

Determines the time signature of the metronome sound.

When you start the song or accompaniment style, the values matching to them are automatically set.

- Determines which sound is used for the metronome.
- Bell Off** Conventional metronome sound, with no bell.
 - Bell On** Conventional metronome sound, with bell.
 - English Voice** Count in English (One, Two, Three, Four)
 - German Voice** Count in German (Eins, Zwei, Drei, Vier)
 - Japanese Voice** Count in Japanese (Ichi, Ni, San, Shi)
 - French Voice** Count in French (Un, Deux, Trois, Quatre)
 - Spanish Voice** Count in Spanish (Uno, Dos, Tres, Cuatro)

Copying and Formatting Disks — Disk

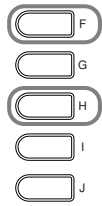
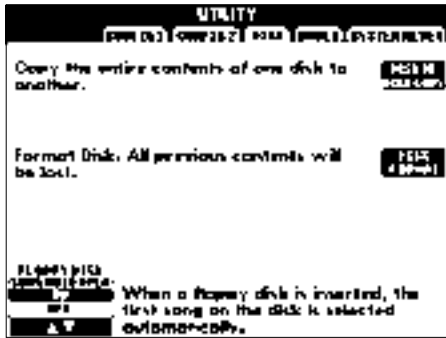

This function copies all the data from one disk to another, letting you back up all your important data before editing. For instructions, see "Copying from Disk to Disk" below.

This function formats a floppy disk (see below).

NOTE

- Copying cannot be done between a 2DD disk and 2HD disk. When copying, make sure both disks are the same type.
- Depending on the amount of data contained in the original source disk, you may have to swap the two disks several times until all of the data is properly copied.
- Make sure to read the section "Using the Floppy Disk Drive (FDD) and Floppy Disks" on page 6.

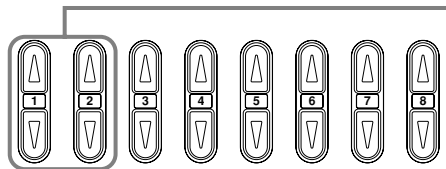

Turns the Song Auto Open function on or off. When this is set to "ON," the PF-1000 automatically calls up the first disk song when a disk is inserted.

Copying from Disk to Disk

As shown below, first copy the data of the original (source) disk to the PF-1000, then copy the data to the backup (destination) disk.

1 Press the [F] button. A message appears, prompting you to insert the source disk.



2 Insert the disk containing the original data into the drive and press "OK."
A "Now copying" message appears, and the PF-1000 begins copying data to internal memory. To abort the operation, press "CANCEL."



3 At the "Please insert a destination disk and press the OK button" prompt, eject the source disk and replace it with a blank, formatted disk, then press "OK." To abort the operation, press "CANCEL."



4 When the operation is finished (or when prompted), eject the destination disk.

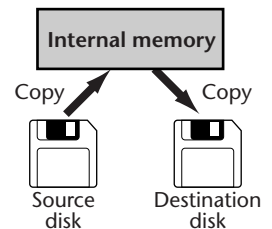

NOTE

Commercially available music data is subject to protection by copyright laws. Copying commercially available data is strictly prohibited, except for your own personal use. Some music software is purposely copy-protected and cannot be copied.

Formatting a Disk

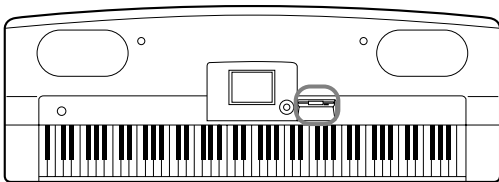

Disk Lamp

When the power is turned on, the disk lamp (at the bottom left of the drive) lights to indicate the drive can be used.

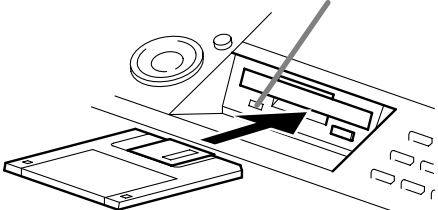

When using an unformatted disk for the first time, make sure to properly format it on the PF-1000. This includes blank disks as well as disks already initialized in a different format. Formatting erases all data on the disk.

Insert the disk with shutter facing away from you and the label side up. To start the Format operation, press the [H] (**DISK FORMAT**) button, in the DISK page above.

NOTE

The Format operation initializes a disk with a specific file system, allowing the corresponding device (in this case, the PF-1000) to access it properly. Since there are several types of formats and disks available, you should know which ones to use with the PF-1000. 2DD disks are formatted to a capacity of 720 KB, and 2HD disks are formatted to a capacity of 1.44 MB.

CAUTION

Formatting a disk completely erases all data on the disk. Make sure that the disk you're formatting does not contain important data!

Entering Your Name and Language Preference — Owner



Press this button to enter an Owner name (page 16; for instructions on naming see page 45). This name is automatically shown when you turn the power on.

NOTE

When “JAPANESE” is selected for the Language parameter, and you change this to one of the western languages, the kanji and kana characters of the file name stored in the disk drive are changed to western characters. In the opposite case, special Latin characters and marks are changed into normal characters. Also, in the case of floppy disk data, text in the files are changed to characters that cannot be read by the instrument. Keep in mind that similar problems may occur when trying to access files originating or edited by a computer having a different language operating system. In general, be careful when switching languages — you risk not being able to access the data properly.

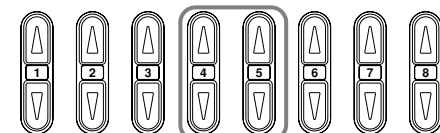

Determines the language used for the display messages. Once you change this setting, all messages will be shown in the selected language.

Restoring the Factory-programmed Settings of the PF-1000 — System Reset

This operation lets you restore the PF-1000 to its original factory settings. These settings include System Setup, MIDI Setup, User Effect, Music Finder, and Files & Folders.

Restores the System Setup parameters to the original factory settings. You can also restore only the System Setup settings by simultaneously holding down the highest key on the keyboard (C7) and turning on the power.

Restores the MIDI templates to the original factory settings.

Restores the User Effects (page 120) to the original factory settings.

Restores the Music Finder data to the original factory settings.

Deletes all files and folders stored in the User page.

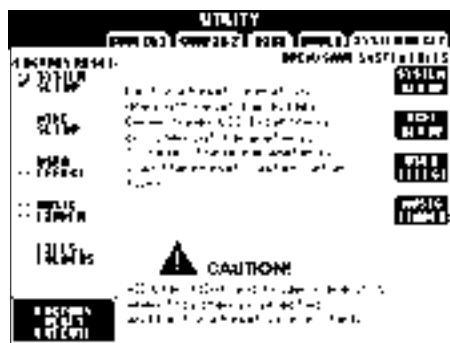

NOTE

The functions and settings below do not apply to the Factory Reset operation. However, you can restore these to their original settings by calling up the preset System Setup files, using the Open/Save System Files function.
Language
Owner Name
LCD Brightness
Video Out settings (NTSC/PAL, Size, Character Color, Background Color)

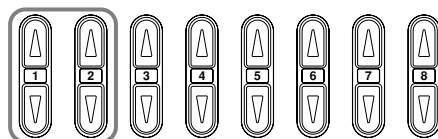

Executes the Factory Reset operation for all items checkmarked above.

These call up the corresponding Open/Save displays. These let you store the corresponding data as files to disk, for future recall. Pressing each of these buttons calls up the corresponding Open/Save display, from which you can select the corresponding PRESET page. From this PRESET page, you can save the relevant data.

NOTE

All Music Finder records can be stored together as a single file. When calling up a stored file, a message appears prompting you to replace or append the records as desired.

Replace:
All Music Finder records currently in the instrument are deleted and replaced with the records of the selected file.

Append:
The records called up are added to the vacant record numbers.

Using Your PF-1000 with Other Devices

⚠ CAUTION

Before connecting the PF-1000 to other electronic components, turn off the power to all the components. Before turning the power on or off to all components, set all volume levels to minimum (0). Otherwise, electrical shock or damage to the components may occur.

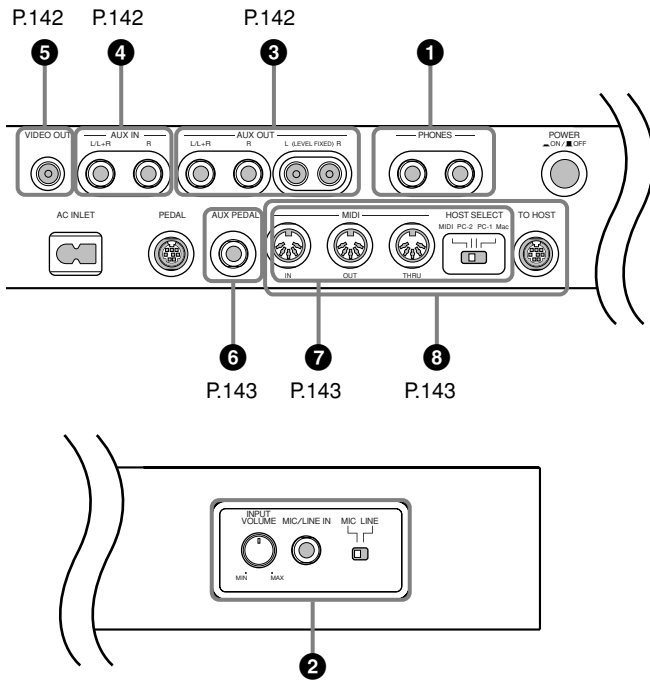

1 Using the Headphones (PHONES jacks).

To use headphones, connect them to one of the PHONES jacks (standard 1/4" phone jacks) located on the left side of the keyboard. You can also determine whether or not the internal stereo speaker system is shut off when a pair of headphones is plugged into the PHONES jack (page 138). Two people can enjoy listening to the PF-1000 together by connecting two pairs of headphones to the two jacks.

2 Connecting the Microphone or Guitar (MIC/LINE IN jack).

By connecting a microphone to the PF-1000, you can enjoy singing along with your own performance or song playback. (A dynamic microphone is recommended.) The PF-1000 outputs your vocals or guitar sounds through the built-in speakers.

- 1 Connect your microphone to the MIC/LINE IN jack (standard 1/4" phone jack).

NOTE

Use an unidirectional microphone for best results.

- 2 Set the [MIC LINE] switch (located next to the [MIC/LINE IN] jack) to the MIC position.

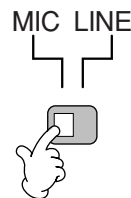

When connecting a microphone

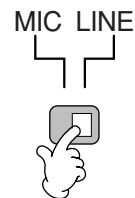

When connecting a guitar

NOTE

You should set the [MIC LINE] switch to the LINE position when connecting an audio source with line-level output to the MIC/LINE IN jack.

- 3 Use the [INPUT VOLUME] knob (located next to the MIC/LINE IN jack) to set the microphone volume.

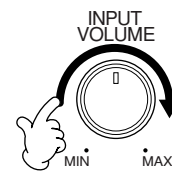

3 4 5 Connecting Audio & Video Devices

You can connect the PF-1000 to a wide range of audio equipment by using the AUX IN and AUX OUT jacks, which are located at the bottom left of the instrument. Connect as shown in the illustrations below using standard audio cables.

NOTE

Use audio cables and adaptor plugs with no resistance.

CAUTION

When the PF-1000 AUX OUT jacks are connected to an external audio system, first turn on the power to the PF-1000, then to the external audio system. Reverse this order when you turn the power off.

3 Playing the sounds of the PF-1000 through an external audio system, and recording the sounds to an external recorder (AUX OUT jacks)

CAUTION

Never connect the PF-1000 AUX OUT jacks to its AUX IN jacks, either directly or via external audio equipment. Such connections could result in a feedback loop that will make normal performance impossible, and may even damage the PF-1000.

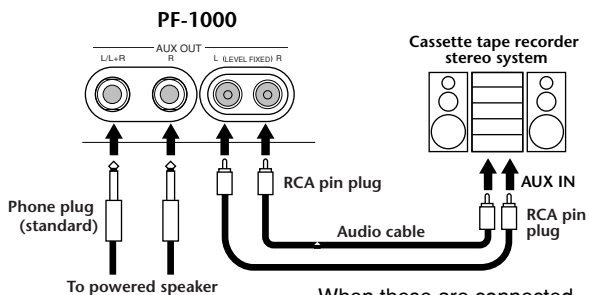

When these are connected (with standard phone plugs), you can use the [MASTER VOLUME] control to adjust the volume of the sound output to the external device.

When these are connected (with RCA pin plug; LEVEL FIXED), the sound is output to the external device at a fixed level, regardless of the [MASTER VOLUME] control setting.

NOTE

- If you connect the PF-1000 to a monaural device, use only the AUX OUT L/L+R jack.

4 Outputting the sound of an external device through the built-in speakers of the PF-1000 (AUX IN jacks)

CAUTION

When the PF-1000's AUX IN jacks are connected to an external device, first turn on the power of the external device, then that of the PF-1000.

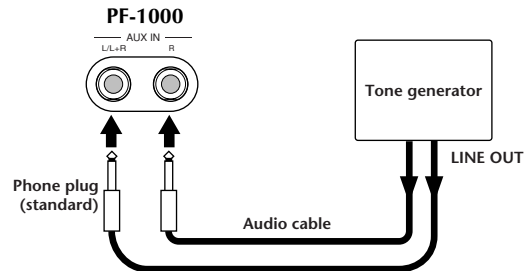

NOTE

- The PF-1000's [MASTER VOLUME] setting affects the input signal from the AUX IN jacks.
- If you connect the PF-1000 to a monaural device, use only the AUX IN L/L+R jack.

5 Showing the display of the PF-1000 on a connected TV monitor (VIDEO OUT)

You can connect the PF-1000 to a television or video monitor to display the lyrics in your song data or LCD on a larger screen.

The size and color of the displayed characters can also be set, as well as the color of the display background (page 133).

NOTE

- For information on setting the video standard (NTSC or PAL), refer to page 133. The default setting is "PAL."
- Use an audio-video cable with good high-frequency characteristics and RCA-type pin jacks to connect the PF-1000 to a television or video monitor.

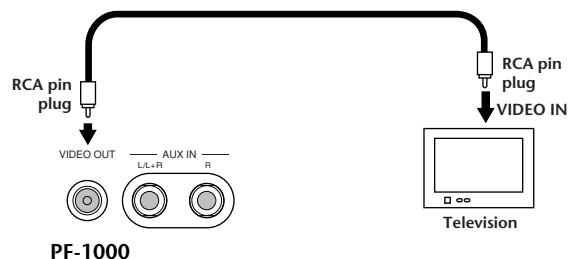

6 Using the Pedal (footswitch) or Foot Controller (AUX PEDAL jack)

By connecting an optional Foot Controller (such as the FC7) to the AUX PEDAL jack, you can control any one of a variety of important functions with your foot — such as dynamically adjusting the volume as you play (page 128).

By connecting a Foot Switch (the FC4 or FC5) to this jack, you can replicate the function of some panel buttons, doing things like starting and stopping accompaniment.

CAUTION

Make sure to connect or disconnect the pedal only when the power is turned off.

7 Connecting external MIDI devices (MIDI terminals)

Using a standard MIDI cable, connect the external MIDI device to the MIDI terminal(s) of the PF-1000. Make sure to set the HOST SELECT switch (page 18) to MIDI when you use these connectors. For more information about connections, see “What You Can Do With MIDI” on page 147.

MIDI IN Receives MIDI messages from an external MIDI device

MIDI OUT Sends out MIDI messages generated by the PF-1000

MIDI THRU Simply relays the MIDI messages received at MIDI IN

For a general overview of MIDI and how you can effectively use it, refer to the following sections:

- What’s MIDI? (page 145)
- What You Can Do With MIDI (page 147)
- MIDI functions (page 134)

NOTE

- Never use MIDI cables longer than 15 meters.

8 Connecting to a Computer (MIDI terminals/TO HOST terminal)

Connect your PF-1000 to computer and take advantage of the wide range of powerful and versatile software for creating and editing music. The PF-1000 can be connected in three ways.

- Using the TO HOST terminal
- Using the MIDI terminals
- Connecting to a USB terminal by using an optional USB interface (UX series)

NOTE

- You’ll need an appropriate music/MIDI software program (such as a sequencer), compatible with your computer platform.
- When connecting the PF-1000 to a personal computer, first turn off the power to both the PF-1000 and the computer before connecting any cables and setting the HOST SELECT switch. After making the proper connections and settings, turn on the power of the computer first, then that of the PF-1000.
- If you do not use the TO HOST terminal of the PF-1000, make sure you disconnect the cable from the terminal. If the cable is left connected, the PF-1000 may not function properly.
- When the HOST SELECT switch is set to “PC-1,” “PC-2,” or “Mac,” you can use the TO HOST terminal, but the MIDI connectors are disabled since no data transfer occurs via the MIDI connectors. On the other hand, when the HOST SELECT switch is set to “MIDI,” you can use the MIDI connectors, but not the TO HOST terminal since no data is transferred via the TO HOST terminal.

Note for Windows users (regarding MIDI driver)

To transfer data via the computer’s serial port and the PF-1000’s TO HOST terminal, you need to install a specified MIDI driver (Yamaha CBX driver for Windows). You can download this driver from the XG Library on the Yamaha Web site:
<http://www.yamaha-xg.com>

Using the TO HOST terminal

Connect the serial port of the personal computer (RS-232C terminal or RS-422 terminal) to the TO HOST terminal of the PF-1000. For the connection cable, use the appropriate cable below (sold separately) that matches the personal computer type.

NOTE

If your system does not work properly with the connections and settings listed above, your software may require different settings. Check your software operation manual and set the HOST SELECT switch to the proper data transfer rate. (Data transfer rate of "PC-1" is 31,250 bps.)

■ IBM-PC/AT (Windows)

Connect the RS-232C terminal on the computer to the TO HOST terminal on the PF-1000 using a serial cable (D-SUB 9P → MINI DIN 8P cross cable). Set the PF-1000 HOST SELECT switch to the "PC-2." (Data transfer rate is 38,400 bps.)

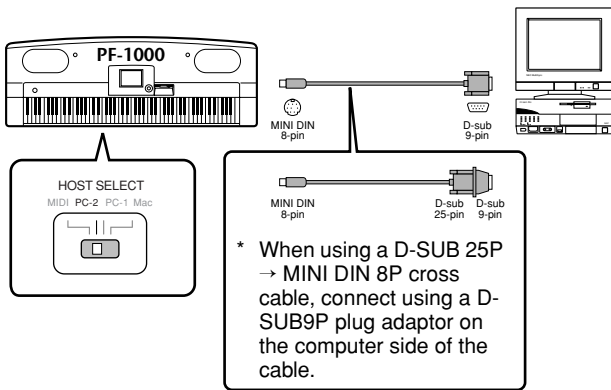

■ Macintosh

Connect RS-422 terminal (modem or printer) on the computer to the TO HOST terminal on the PF-1000 using a serial cable (system peripheral cable, 8 bit). Set the PF-1000 HOST SELECT switch to the "MAC" (Data transfer rate is 31,250 bps).

Set the MIDI interface clock in the sequencer you are using to 1 MHz. For details, refer to the owner's manual for the particular software you are using.

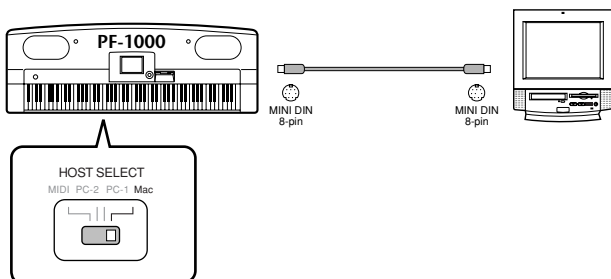

Using the MIDI terminals

When using a MIDI interface device installed in the personal computer, connect the MIDI terminals of the personal computer and the PF-1000 with standard MIDI cables.

- When the computer has a MIDI interface installed, connect the MIDI OUT terminal of the personal computer to the MIDI IN terminal. Set the HOST SELECT switch to "MIDI."

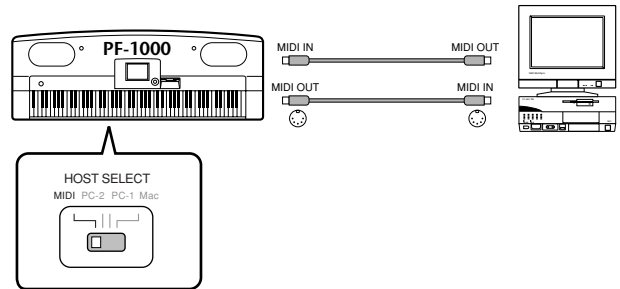

- When using a MIDI interface with a Macintosh series computer, connect the RS-422 terminal of the computer (modem or printer terminal) to the MIDI interface, then connect the MIDI OUT terminal on the MIDI interface to the MIDI IN terminal of the PF-1000, as shown in the diagram below. Set the HOST SELECT switch to "MIDI."

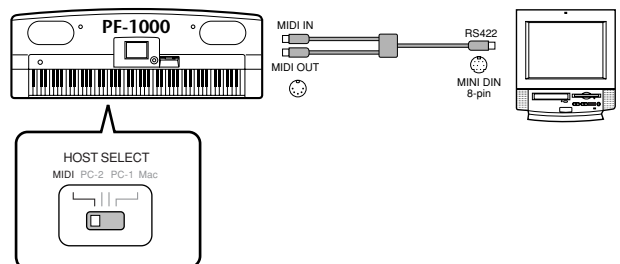

- When the HOST SELECT switch is set to "MIDI," the TO HOST terminal is disabled.
- When using a Macintosh series computer, set the MIDI interface clock setting in the application software to match the setting of the MIDI interface you are using. For details, refer to the owner's manual for the particular software you are using.

Using the USB terminal on your computer with a USB/MIDI interface (UX256/UX96/UX16, etc.)

Connect the UX256/UX96/UX16 and the computer with a USB cable. Install the included UX256/UX96/UX16 driver to the computer, and connect the UX256/UX96/UX16 to the PF-1000 with a MIDI cable. Set the HOST SELECT switch on the PF-1000 to "MIDI." For details, refer to the owner's manual of the UX256/UX96/UX16.

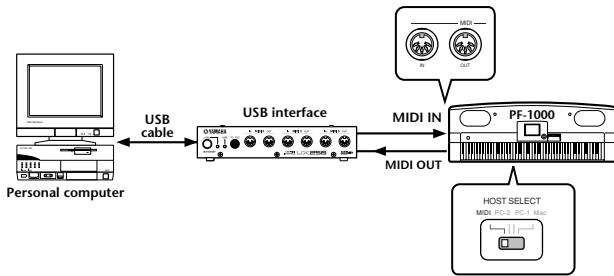

For details about the necessary MIDI settings for computer and sequence software you are using, refer to the relevant owner's manuals.

What's MIDI?

Let's consider an acoustic piano and a classical guitar as representative acoustic instruments. With the piano, you strike a key, and a hammer inside hits some strings and plays a note. With the guitar, you directly pluck a string and the note sounds. But how does a digital instrument go about playing a note?

Acoustic guitar note production

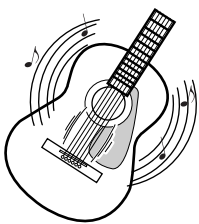

Pluck a string and the body resonates the sound.

Digital instrument note production

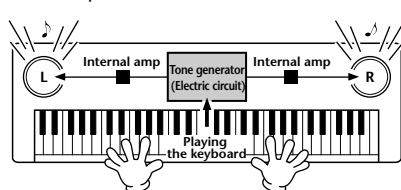

Based on playing information from the keyboard, a sampled note stored in the tone generator is played through the speakers.

As shown in the illustration above, in an electronic instrument, the sampled note (previously recorded note) stored in the **tone generator section** (electronic circuit) is played based on information received from the keyboard, and output through the speakers.

Now let's examine what happens when we play back a recording. When you playback a music CD (for example, a solo piano recording), you're hearing the actual sound (vibrations in air) of the acoustic instrument. This is called audio data, to distinguish it from MIDI data.

Recording and playing back the performance of an acoustic instrument (audio data)

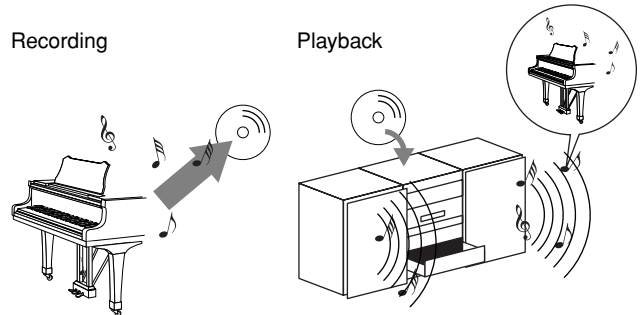

In the above example, the actual acoustic sounds of the pianist's performance are captured in the recording as audio data, and this is recorded to CD. When you play back that CD on your audio system, you can hear the actual piano performance. The piano itself is not necessary, since the recording contains the actual sounds of the piano, and your speakers reproduce them.

Recording and playing back the performance of a digital instrument (MIDI data)

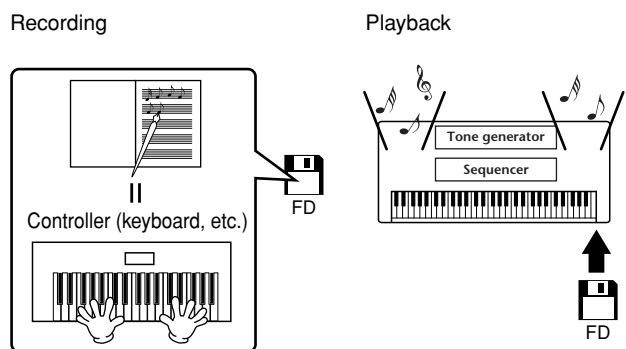

NOTE

In the case of digital instruments, the audio signals are sent through output jacks (such as AUX OUT) on the instrument.

The “controller” and “tone generator” in the illustration above are equivalent to the piano in our acoustic example. Here, the player’s performance on the keyboard is captured as MIDI song data (see illustration below). In order to record the audio performance on an acoustic piano, special recording equipment is needed. However, since the PF-1000 features a built-in **sequencer** that lets you record performance data, this recording equipment is unnecessary. Instead, your digital instrument — the PF-1000 — allows you to both record and play back the data.

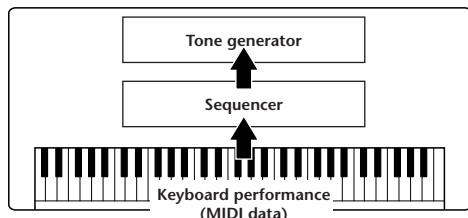

However, we also need a sound source to produce the audio, which eventually comes from your speakers. The **tone generator** of the PF-1000 fills this function. The recorded performance is reproduced by the sequencer, playing back the song data, using a tone generator capable of accurately producing various instrument sounds — including that of a piano. Looked at in another way, the relation of the sequencer and the tone generator is similar to that of the pianist and the piano — one plays the other. Since digital instruments handle playback data and the actual sounds independently, we can hear our piano performance played by another instrument, such as guitar or violin.

NOTE

Even though it is a single musical instrument, the PF-1000 can be thought of as containing several electronic components: a controller, a tone generator, and a sequencer.

Finally, we’ll take a look at the actual data that gets recorded and that serves as the basis for playing the sounds. For example, let’s say you play a “C” quarter note using the grand piano sound on the PF-1000 keyboard. Unlike an acoustic instrument that puts out a resonated note, the electronic instrument puts out information from the keyboard such as “with what voice,” “with which key,” “about how strong,” “when was it pressed” and “when was it released.” Then each piece of information is changed into a number value and sent to the tone generator. Using these numbers as a basis, the tone generator plays the stored sampled note.

■ **Example Keyboard Data**

Voice number (with what voice)	01 (grand piano)
Note number (with which key)	60 (C3)
Note on (when was it pressed) and note off (when was it released)	Timing expressed numerically (quarter note)
Velocity (about how strong)	120 (strong)

Panel operations on the PF-1000, such as playing the keyboard and selecting voices, are processed and stored as MIDI data. The auto accompaniment styles and songs also consist of MIDI data.

MIDI is an acronym that stands for Musical Instrument Digital Interface, which allows electronic musical instruments to communicate with each other, by sending and receiving compatible Note, Control Change, Program Change and various other types of MIDI data, or messages.

The PF-1000 can control a MIDI device by transmitting note related data and various types of controller data. The PF-1000 can be controlled by incoming MIDI messages which automatically determine the tone generator mode, select MIDI channels, voices and effects, change parameter values and of course play the voices specified for the various parts.

NOTE

- MIDI data has the following advantages over audio data:
- The amount of data is much less, letting you easily store MIDI songs to floppy disk.
 - The data can be effectively and easily edited, even to the point of changing voices and transforming the data.

MIDI messages can be divided into two groups: Channel messages and System messages.

■ **Channel Messages**

The PF-1000 is an electronic instrument that can handle 16 channels (or 32 channels, when using the TO HOST terminal). This is usually expressed as “it can play 16 instruments at the same time.” Channel messages transmit information such as Note ON/OFF, Program Change, for each of the 16 channels.

Message Name	PF-1000 Operation/Panel Setting
Note ON/OFF	Messages which are generated when the keyboard is played. Each message includes a specific note number which corresponds to the key which is pressed, plus a velocity value based on how hard the key is played.
Program Change	Voice selecting (control change bank select MSB/LSB setting)
Control Change	Volume, panpot (Mixing Console), etc.

NOTE

The performance data of all songs and styles is handled as MIDI data.

MIDI channels

MIDI performance data is assigned to one of sixteen MIDI channels. Using these channels, 1 - 16, the performance data for sixteen different instrument parts can be simultaneously sent over one MIDI cable.

Think of the MIDI channels as TV channels. Each TV station transmits its broadcasts over a specific channel. Your home TV set receives many different programs simultaneously from several TV stations and you select the appropriate channel to watch the desired program.

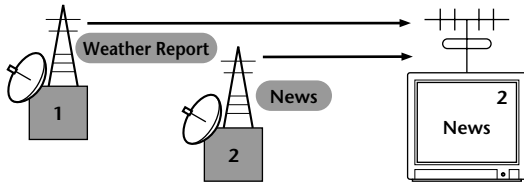

MIDI operates on the same basic principle. The transmitting instrument sends MIDI data on a specific MIDI channel (MIDI Transmit Channel) via a single MIDI cable to the receiving instrument. If the receiving instrument's MIDI channel (MIDI Receive Channel) matches the Transmit Channel, the receiving instrument will sound according to the data sent by the transmitting instrument.

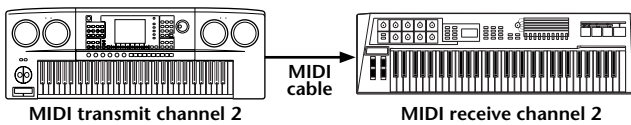

NOTE

The PF-1000's keyboard and internal tone generator are also connected by MIDI (page 134).

For example, several tracks (channels) can be transmitted simultaneously, including the style data (as shown below).

Example: Recording the auto accompaniment of the PF-1000 to an external sequencer

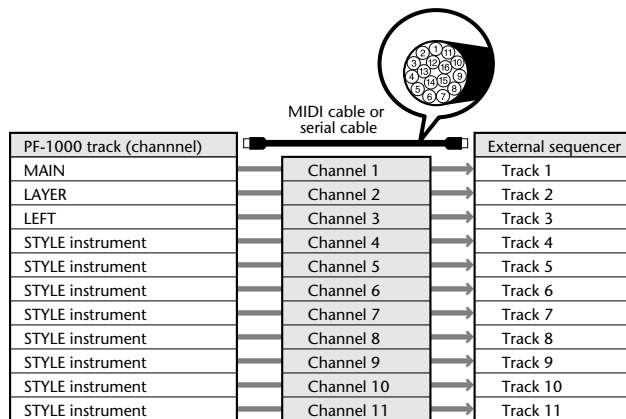

As you can see, it is essential to determine which data is to be sent over which MIDI channel when transmitting MIDI data (page 135). The PF-1000 also allows you to determine how the received data is played back. (page 136).

System Messages

This is data that is used in common by the entire MIDI system. System messages include messages like Exclusive Messages that transmit data unique to each instrument manufacturer and Realtime Messages that control the MIDI device.

Message Name	PF-1000 Operation/Panel Setting
System Exclusive Message	Effect type settings (Mixing Console), etc.
Realtime Messages	Clock setting, Start/stop operation

The messages transmitted/received by the PF-1000 are shown in the MIDI Data Format and MIDI Implementation Chart in the separate Data List.

What You Can Do With MIDI

The following MIDI settings can be made on the PF-1000:

- MIDI templates (preset MIDI setups for various applications) (page 134)
 - Transmit (page 135)
 - Receive (page 136)
 - Local Control (page 134)
 - Clock (page 135)
- Record performance data (1-16 channels) using the PF-1000 Auto Accompaniment features on a external sequencer (such as a personal computer). After recording, edit the data with the sequencer, then play it again on the PF-1000 (playback).

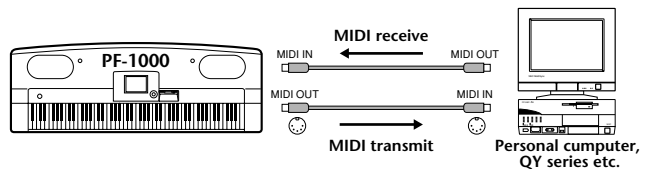

When you want to use the PF-1000 as an XG-compatible multi-timbral tone generator, set the receive part for MIDI channels 1 to 16 to "SONG" in MIDI Receive (page 136).

- Play and control the PF-1000 from a separate keyboard

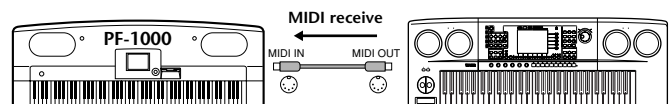

Data Compatibility

This section covers basic information on data compatibility: whether or not other MIDI devices can playback the data recorded by PF-1000, and whether or not the PF-1000 can playback commercially available song data or song data created for other instruments or on a computer. Depending on the MIDI device or data characteristics, you may be able to play back the data without any problem, or you may have to perform some special operations before the data can be played back. If you run into problems playing back data, please refer to the information below.

Disk format

Floppy disks are the main storage medium for data used with various devices, including computers. Different devices have different systems of storing data, therefore it is necessary to first configure the floppy disk to the system of the device being used. This operation is called "formatting."

- There are two types of floppy disks: MF2DD (double sided, double density) and MF2HD (double sided, high density), and each type has different formatting systems.
- PF-1000 can record and playback with both types of floppy disks.
- When formatted by the PF-1000, a 2DD disk stores up to 720 KB (kilobytes) and a 2HD disk stores up to 1.44 MB (megabytes). (The figures "720 KB" and "1.44MB" indicate the data memory capacity. They are also used to indicate the format type of disk.)
- Playback is only possible when the MIDI device to be used is compatible with the format of the disk.

Sequence Format

The system which records song data is called "sequence format."

Playback is only possible when the sequence format of the disk matches that of the MIDI device. The PF-1000 is compatible with the following formats.

■ SMF (Standard MIDI File)

This is the most common sequence format. Standard MIDI Files are generally available as one of two types: Format 0 or Format 1. Many MIDI devices are compatible with Format 0, and most commercially available software is recorded as Format 0.

- The PF-1000 is compatible with both Format 0 and Format 1.
- Song data recorded on the PF-1000 is automatically recorded as SMF Format 0.
- Song data loaded to the PF-1000 is automatically saved as SMF Format 0 regardless of the original format.

■ ESEQ

This sequence format is compatible with many of Yamaha's MIDI devices, including the PF-1000 series instruments. This is a common format used with various Yamaha software.

■ XF

The Yamaha XF format enhances the SMF (Standard MIDI File) format with greater functionality and open-ended expandability for the future.

- The PF-1000 is capable of displaying lyrics when an XF file containing lyric data is played.

■ Style File

The Style File Format – SFF – is Yamaha's original style file format which uses a unique conversion system to provide high-quality automatic accompaniment based on a wide range of chord types.

Voice Allocation Format

With MIDI, voices are assigned to specific numbers, called “program numbers.” The numbering standard (order of voice allocation) is referred to as the “voice allocation format.”

Voices may not play back as expected unless the voice allocation format of the song data matches that of the compatible MIDI device used for playback.

The PF-1000 is compatible with the following formats.

NOTE

Even if the devices and data used satisfy all the conditions above, the data may still not be completely compatible, depending on the specifications of the devices and particular data recording methods.

■ GM System Level 1

This is one of the most common voice allocation formats.

- Many MIDI devices are compatible with GM System Level 1, as is most commercially available software.

■ XG

XG is a major enhancement of the GM System Level 1 format, and was developed by Yamaha specifically to provide more voices and variations, as well as greater expressive control over voices and effects, and to ensure compatibility of data well into the future.

- Song data recorded on the PF-1000 using voices in the [XG] category is XG-compatible.

■ DOC

This voice allocation format is compatible with many of Yamaha’s MIDI devices, including the PF-1000 series instruments. This is also a common format used with various Yamaha software.

Assembling the Keyboard Stand

You can use the PF-1000 without installing the stand. However, if you wish to attach the stand to the PF-1000, follow the steps below.

⚠ CAUTION

- Be careful not to confuse parts. Make sure that you install all parts in the correct orientation. Assemble the stand in accordance with the steps below.
- At least two persons should assemble the stand together.
- Be sure to use the correct-size screws, as indicated below. Use of incorrect screws can cause damages to the stand.
- When you attach each part, be sure to tighten all screws.
- Reverse the assembly procedure to disassemble the stand.

Use the included wrench.



Keyboard

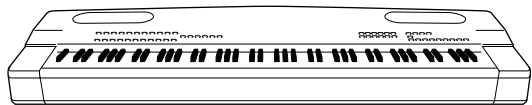

Remove the following parts from the package.

Plate

Stand

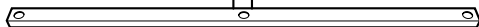

Rear left leg



Rear right leg



Front right leg

Front left leg

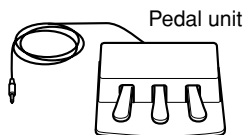

Pedal unit

AC power cord



Screws



Long screws (6x65mm) x 8



Short screws (6x20mm) x 8



Cord holders x 2

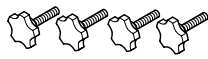

Cap bolts x 4

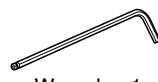

Wrench x 1

1 Attaching the front legs to the stand.

- 1 Place the stand on the floor so that the bottom side (with smaller holes) faces up.

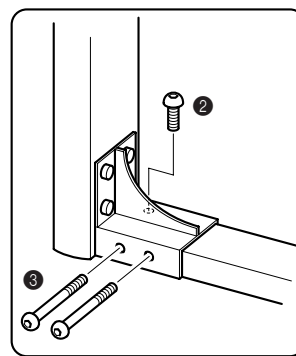
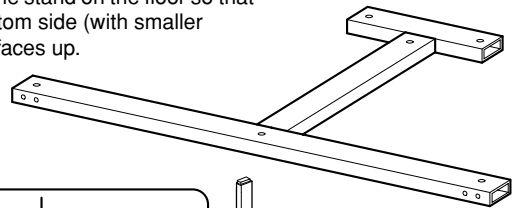

- 2 Use a short screw to attach the bracket of the front right leg to the bottom side of the stand.

- 3 Use two long screws to fix the bracket of the front right leg to the front side of the stand.

- 4 Attach the front left leg in the same way.

2 Attaching the rear legs to the stand.

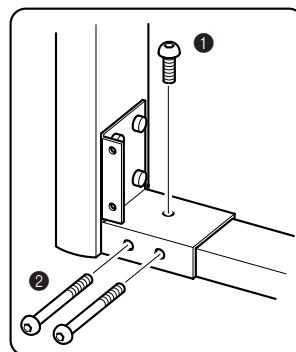

- 1 Use a short screw to attach the bracket of the rear left leg to the bottom side of the stand.

- 2 Use two long screws to fix the bracket of the rear left leg to the rear side of the stand.

- 3 Attach the rear right leg in the same way.

3 Attaching the plate.

Align the holes on the plate with the holes of the rear side of the bracket on the rear legs, then fix them using four short screws.

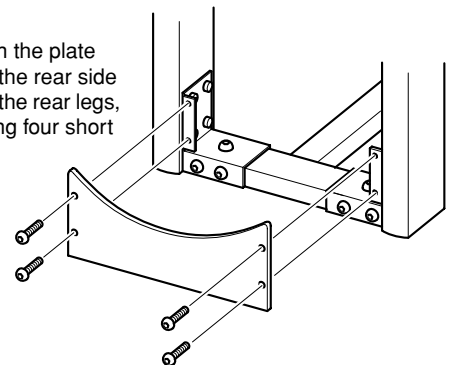

4 Raising the stand to the standing position.

Use the front legs as support to raise the stand.

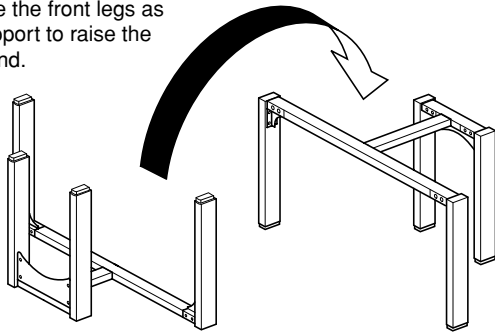

CAUTION

Be careful not to pinch your fingers.

5 Mounting the keyboard.

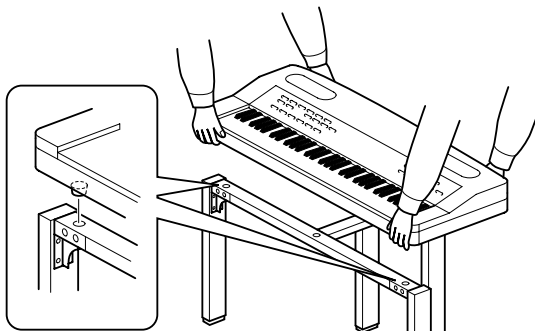

Be sure to hold the four corners of the keyboard. Mount the keyboard so that the rubber feet on the bottom of the keyboard fall into the holes on the stand.

CAUTION

Be careful not to pinch your fingers or drop the keyboard.

CAUTION

Do not hold any part of the keyboard other than four corners as shown in the illustration.

6 Fixing the keyboard.

Attach the cap bolts on the bottom of the stand and tighten them with your hand to fix the keyboard.

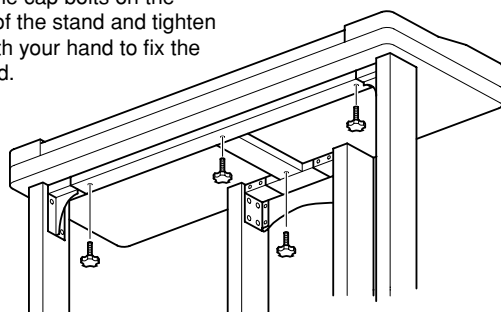

7 Connecting the pedal unit.

1 Place the pedal unit in front of the rear legs.

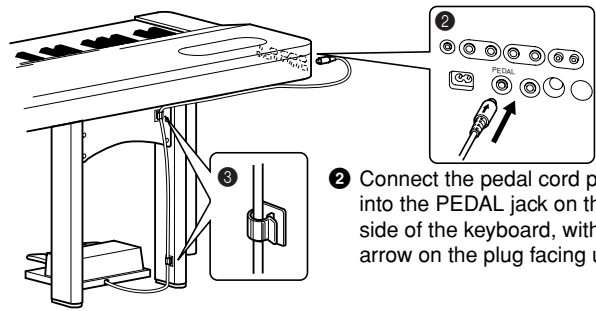

2 Connect the pedal cord plug into the PEDAL jack on the left side of the keyboard, with the arrow on the plug facing up.

3 Attach the cord holders in the position shown in the illustration, and clip the pedal cord to the holders.

* You can also clip the power cord to the cord holders.

8 Set the voltage selector and connect the power cord to the AC INLET on the keyboard.

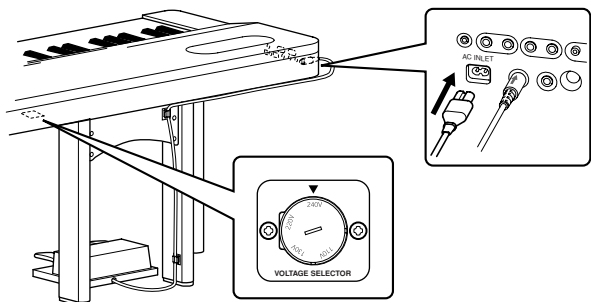

Voltage Selector

Before connecting the AC power cord, check the setting of the voltage selector (provided in some locations). To set the selector for 110V, 130V, 220V or 240V main voltages, use a "minus" screwdriver to rotate the selector dial so that the correct voltage for your region appears next to the pointer on the panel. The voltage selector is set at 240V when the unit is initially shipped.

After the proper voltage has been selected, connect the AC power cord to the AC INLET and an AC wall outlet. A plug adaptor may also be provided in some areas to match the pin configuration of the AC wall outlets in your area.

WARNING

An improper voltage setting can cause serious damage to the PF-1000 or result in improper operation.

After completing the assembly, please check the following.

- Are any parts left over?
 - Review the assembly procedure and correct any errors.
- Is the PF-1000 clear of doors and other movable fixtures?
 - Move the PF-1000 to an appropriate location.
- Does the PF-1000 make a rattling noise when you shake it?
 - Tighten all screws.
- Are the pedal and power cords inserted securely into the sockets?
 - Check the connections.
- If the keyboard stand creaks or is otherwise unsteady when you play the keyboard, refer to the assembly diagrams and retighten all screws.

Troubleshooting

Problem	Possible Cause and Solution
<ul style="list-style-type: none"> The PF-1000 does not turn on; there is no power. 	<p>Make sure that the PF-1000 has been plugged in properly. Securely insert the female plug into the AC socket on the PF-1000, and the male plug into a proper AC outlet (page 16).</p>
<ul style="list-style-type: none"> A click or pop is heard when the power is turned on or off. 	<p>This is normal when electrical current is applied to the instrument.</p>
<ul style="list-style-type: none"> Noise is heard from the PF-1000's speakers. 	<p>Using a mobile phone in close proximity to the PF-1000 may produce interference. To prevent this, turn off the mobile phone, or use it further away from the PF-1000.</p>
<ul style="list-style-type: none"> The display is too bright or too dark to read. 	<p>The brightness of the display may be affected by the surrounding temperature; try adjusting the contrast (page 17).</p>
<ul style="list-style-type: none"> The keyboard volume is low compared to that of the Auto Accompaniment or song playback. 	<p>The overall keyboard volume or the independent volume level of the keyboard part may be set too low. Raise the MAIN/LAYER/LEFT volume voices or lower the STYLE/SONG volume in the BALANCE display (page 61).</p>
<ul style="list-style-type: none"> The volume of the Auto Accompaniment or song playback is low compared to that of the keyboard. 	<p>The volume level of one or more accompaniment parts or song channels is set too low. Raise the part or channel level(s) in the appropriate MIXER display (page 117).</p>
<ul style="list-style-type: none"> The overall volume is low, or no sound is heard. 	<ul style="list-style-type: none"> The Master Volume is set too low; set it to an appropriate level with the [MASTER VOLUME] dial. The volume of the individual parts may be set too low. Raise the volume of MAIN, LAYER, LEFT, STYLE, and SONG in the BALANCE display (page 61). Make sure the desired channel is set to ON (page 61, 76). Headphones are connected, disabling the speaker output. (This happens when the speaker setting is set to "HEADPHONE SW"; page 138.) Unplug the headphones. Make sure the speaker setting is set to ON (page 138). Make sure the Local Control function is set to ON (page 134).
<ul style="list-style-type: none"> The damper, sostenuto and soft functions do not work for the relevant pedals. 	<p>Each pedal has been assigned to a different function. Make sure that each pedal is properly assigned to SUSTAIN, SOSTENUTO, and SOFT (page 128).</p>
<ul style="list-style-type: none"> The damper pedal has no effect, or the sound continuously sustains even when the damper pedal is not pressed. 	<p>The pedal cable/plug may not be properly connected. Make sure to securely insert the pedal plug into the proper jack (page 150 - 151).</p>
<ul style="list-style-type: none"> Not all simultaneously-played notes sound. 	<p>You may be exceeding the maximum polyphony of the PF-1000. When this happens, the earliest played notes will stop sounding, letting the latest played notes sound. See page 154 for information on the maximum polyphony.</p>
<ul style="list-style-type: none"> Accompaniment style or Song playback does not start. 	<ul style="list-style-type: none"> MIDI Clock may be set to "EXTERNAL." Make sure this is set to "INTERNAL" (page 135). Make sure to press the appropriate [START/STOP] button. To play an accompaniment style, press the STYLE CONTROL [START/STOP] button (page 61); to playback a song, press the SONG [START/STOP] button (page 74). "New Song" (a blank song) has been selected. Make sure to select an appropriate song in the SONG display (page 74). The song has been stopped at the end of the song data. Return to the beginning of the song by pressing the [TOP] button (page 76).
<ul style="list-style-type: none"> Only the rhythm channel plays. 	<p>Make sure the Auto Accompaniment function is turned on; press the [ACMP] button.</p>
<ul style="list-style-type: none"> The accompaniment style does not start, even when Synchro Start is in standby condition and a key is pressed. 	<p>You may be trying to start accompaniment by playing a key in the right hand range of the keyboard. Make sure to play a key in the left-hand (accompaniment) range of the keyboard.</p>
<ul style="list-style-type: none"> The desired chord is not recognized or output by the auto accompaniment. 	<ul style="list-style-type: none"> You may not be playing the correct keys to indicate the chord. Refer to "Chord Types Recognized in the Fingered Mode" (page 63). You may be playing the keys according to a different fingering mode, and not the one currently selected. Check the accompaniment mode, and play the keys according to the selected mode (page 62).

Problem	Possible Cause and Solution
<ul style="list-style-type: none"> Auto accompaniment chords are recognized regardless of the split point or where chords are played on the keyboard. 	<p>This is normal if the fingering mode is set to "Full Keyboard" or "AI Full Keyboard." If either of these is selected, chords are recognized over the entire range of the keyboard, irrespective of the split point setting. If desired, select a different fingering mode (page 62).</p>
<ul style="list-style-type: none"> Certain notes sound at the wrong pitch. 	<p>The Scale parameter has probably been set to something other than "Equal," changing the tuning system of the keyboard. Make sure "Equal" is selected as the Scale in the Scale Tune page (page 124).</p>
<ul style="list-style-type: none"> Some channels do not properly play back when playing back song data. 	<p>Make sure that playback of the relevant channel(s) is turned on (page 76).</p>
<ul style="list-style-type: none"> The Harmony function does not operate. 	<p>Harmony cannot be used with the Full Keyboard or AI Full Keyboard fingering modes. Select an appropriate fingering mode (page 62).</p>
<ul style="list-style-type: none"> The microphone input signal cannot be recorded. 	<p>This is normal; recording the audio input of the microphone is not possible.</p>
<ul style="list-style-type: none"> MIDI data is not transmitted or received via the MIDI terminals, even when MIDI cables are connected properly. 	<p>Make sure the HOST SELECT switch is set to "MIDI" (page 144). The MIDI terminals cannot be used for the other switch settings.</p>
<ul style="list-style-type: none"> When a voice is changed, the previously selected effect is changed. 	<p>Each voice has its own suitable preset values which are automatically recalled when the corresponding Voice Set parameters are turned on (page 132).</p>
<ul style="list-style-type: none"> There is a slight difference in sound quality between notes played on the keyboard. Some voices have a looping sound. Some noise or vibrato is noticeable at higher pitches, depending upon the voice. 	<p>This is normal and is a result of the PF-1000's sampling system.</p>
<ul style="list-style-type: none"> Some voices will jump an octave in pitch when played in the upper or lower registers. 	<p>This is normal. Some voices have a pitch limit which, when reached, causes this type of pitch shift.</p>
<ul style="list-style-type: none"> Even though a Registration Memory setting containing a User voice is selected, the Open/Save display shows a Preset voice. 	<p>This is normal; even with the Preset voice shown, the actual sounding voice is the selected User voice. When a User voice is registered to the User drive or floppy disk, the actual registered is: 1) the source Preset voice, and 2) the parameter settings as set in the Sound Creator. When you recall a Registration Memory setting containing a User voice, the PF-1000 selects the Preset voice (on which the User voice is based), then applies the relevant parameter settings to it — so that your original User voice is sounded.</p>
<ul style="list-style-type: none"> Disk save operations take a long time. 	<p>This is normal. Keep in mind that it takes approximately 1 minute to save 1 megabyte of data to a floppy disk.</p>
<ul style="list-style-type: none"> The voice produces excessive noise. 	<p>Certain voices may produce noise, depending on the Harmonic Content and/or Brightness settings in the FILTER page of the Mixing Console display (page 118).</p>
<ul style="list-style-type: none"> The sound is distorted or noisy. 	<ul style="list-style-type: none"> The volume may be turned up too high. Make sure all relevant volume settings are appropriate. This may be caused by the effects. Try canceling all unnecessary effects, especially distortion-type effects (page 119). Some filter resonance settings in the Custom Voice Creator display (page 88) can result in distorted sound. Adjust these settings if necessary.
<ul style="list-style-type: none"> A strange "flanging" or "doubling" sound occurs. Also, the sound is slightly different each time the keys are played. 	<p>Both the Main and Layer parts are set to "ON," and both parts are set to play the same voice. Set the Layer part to "OFF" (page 56) or change the voice for each part (page 54).</p>

Specifications

○: available

		PF-1000		
Sound Source		AWM Dynamic Stereo Sampling		
Display		320 × 240 dots backlit graphic LCD		
Keyboard		88 keys (A-1 - C7)		
Voice	Polyphony (max)		96	
	Voice Selection		308 voices + 480 XG voices + 16 Drum Kits	
		Regular Voice	287	
		Sweet Voice	8	
		Cool Voice	2	
		Live Voice	1	
Natural Voice		21		
Sound creator		○		
Effects	Effect Blocks	Reverb	2	
		Chorus	2	
		DSP	2	
		Brilliance	1	
	Effect Types	REVERB1	28+3 User	
		REVERB2	5	
		CHORUS1	21+3 User	
		CHORUS2	3	
		DSP1	101+3 User	
		DSP2	12	
		Brilliance	5	
	Accompaniment Style	Accompaniment Styles		194
		Session Styles		12
Pianist Styles		36		
Piano Combo Styles		17		
Fingering		Single Finger, Fingered, Fingered On Bass, Multi Finger, AI Fingered, Full Keyboard, AI Full Keyboard		
Style Creator		○		
OTS (One Touch Setting)		Accompaniment Style		
OTS link		○		
Music Finder		Approximately 2500 records		
	Edit	○		
Song	Format		SMF (Format 0,1), ESEQ	
	Preset Songs		○	
	Lyrics		○	
	Score		○	
	Recording	Quick Recording, Multi Recording, Step Recording, Song Editing		
Record Channels		16		
Memory Device	Floppy Disk (2HD,2DD)		○	
	Flash Memory (internal)		1MB	
	Flash Availability		Song (SMF), Style (SFF), Registration, Voice, etc.	
Tempo	Tempo Range		5 - 500	
	Tap Tempo		○	
	Metronome		○	
		Sound	Bell on/off, Human Voices (5 languages)	

		PF-1000
Registration Memory	Buttons	8
	Regist Sequence	○
	Freeze	○
Others	Demo	Function, Voice, Style
	Language	6 languages (English, Japanese, German, French, Spanish, Italian)
	Help	○
	Direct Access	○
	Piano setting button (including Piano Lock)	○
	Master Volume	○
	Fade In/Out	○
	Transpose	Keyboard/Song/Master
	Tuning	○
	Tuning Curve	Flat/Stretch (Natural Piano Voice only)
	Scale	Equal Temperament, Pure Major/Pure Minor, Pythagorean, Mean Tone, Werckmeister/Kirnberger, Arabic 1/2
	Touch Response	5 level
Jacks/Connectors		PHONES × 2, MIDI (THRU, OUT, IN), TO HOST, HOST SELECT, AUX PEDAL, AUX IN (L/L+R), AUX OUT (LEVEL FIXED) (L/R), AUX OUT (L/L+R) MIC (INPUT VOLUME, MIC/LINE IN), VIDEO OUT
Pedals	Number of Pedals	3
	Pedal Functions	VOLUME, SUSTAIN, SOSTENUTO, SOFT, GLIDE, PORTAMENTO, PITCHBEND, MODULATION, DSP VARIATION, VIBROTOR ON/OFF, SONG START/STOP, STYLE START/STOP, etc.
Amplifiers/ Speakers	Amplifiers	30 W × 2
	Speakers	(16 cm + 5 cm) × 2
Dimensions [W × D × H] (without music rest, pedal unit)	main unit	1430 × 507 × 165 mm [56-5/16" × 19-15/16" × 6-1/2"]
	main unit with keyboard stand	1430 × 507 × 782 mm [56-5/16" × 19-15/16" × 30-7/8"]
Weight (without music rest, pedal unit)	main unit	31 Kg [68 lbs., 5 oz]
	main unit with keyboard stand	43 Kg [94 lbs., 13 oz]

* Specifications and descriptions in this owner's manual are for information purposes only. Yamaha Corp. reserves the right to change or modify products or specifications at any time without prior notice. Since specifications, equipment or options may not be the same in every locale, please check with your Yamaha dealer.

Index

Numerics

1 - 16	103
[1▲▼] - [8▲▼] buttons	18, 38–45

A

[A] - [J] buttons	18, 40
[AC INLET]	16, 19
Accessories	6
Accompaniment style parts	92
[ACMP] button	18, 60
Adjust the Volume Balance and Changing Voices	116
Adjusting the display contrast	17
Adjusting the Effects	119
Adjusting the Tempo	50
Adjusting the Volume Balance	61
Adjusting the Volume Balance / Muting Specific Channels	76
Adjusting values	46
AI	62
AI FINGERED	62
AI FULL KEYBOARD	62
Append	71
Applying Voice Effects	57
Appropriate Panel Setting for the Selected Style	67
Arabic	125
Arranging the Style Pattern	64
Assembling an Accompaniment Style	110
Assembling the keyboard stand	150
ATTACK	88
AUTO	20
Auto Revoice	117
[AUTO FILLIN] button	18, 66
Automatically Changing One Touch Settings with the Sections	68
AUX IN [L / L+R] [R] jacks	19, 142
AUX OUT (LEVEL FIXED) [L] [R] jacks	19, 142
AUX OUT [L / L+R] [R] jacks	19, 142
[AUX PEDAL] jack	19, 143

B

[BACK] button	18, 40, 46
[BALANCE] button	18, 61
Bar Clear	113
Bar Copy	113
Base note	124
Basic Operations — Organizing Your Data	38
Bass	92
BEAT	70, 71
[BREAK] button	18, 64
BRIGHTNESS	88

C

Calling Up Ideal Setups for Your Music	69
Cent	124
Change the Rhythmic Feel	111
Changing Pitch-related Settings	118
Changing the Automatically Selected Voice Settings	132
Changing the Icon	46
Changing the Tone of the Voice	118
Changing the Touch Sensitivity and Transpose	130
Channel	61, 76, 100, 113, 126
Channel Messages	146

Channel Muting	61
[CHANNEL ON / OFF] button	18, 61, 76
Channel Transpose	102
CHD	104
Chord	92
Chord Detect	136
Chord Events	104
Chord Fingering	62, 128
Chord Tutor	128
Chord Types Recognized in the Fingered Mode	63
Chorus	121
Clock	135
COMMON	87
Compatible Song Types	73
CONFIG 1	137
CONFIG 2	138
Connect the power cord	16
Connecting Audio & Video Devices	142
Connecting external MIDI devices	143
Connecting the Microphone or Guitar	141
Connecting to a Computer	143
Controller	128
Converting into Kanji (Japanese language)	45
Cool!	55
COPY	43
Copying and Formatting Disks	139
Copying Files/Folders	43
Copying from Disk to Disk	139
Creating Accompaniment Styles	106
Current Memory	39
Customizing the Event List — Filter	105
CUT	42

D

Damper pedal	19, 58
Data Compatibility	148
[DATA ENTRY] dial	18, 46
Data Types in the MIDI TRANSMIT/RECEIVE Display	135
DECAY	88
DELETE	43
Delete	101
DELETE RECORD	71
Deleting Files/Folders	43
[DEMO] button	14, 18, 52
DEPTH	88
Detailed Settings for Notation	79
[DIGITAL RECORDING] button	14, 18, 90, 106
[DIRECT ACCESS] button	18, 47
Direct Access Chart	48
Disk	139
Disk format	148
Disk Orchestra Collection	19
Displaying Music Notation	78
Displaying the Lyrics	81
Displaying Upper Level pages	44
DOC	149
Drum	55
[DSP] button	18, 57, 121
Dynamics	112

E

ECHO	58, 132
------------	---------

EDIT	109
Edit the Created Accompaniment Style	111
Editing a Recorded Song	100
Editing Channel-related Parameters	100
Editing Chord Events	104
Editing Note Events	103
Editing Records	71
Editing System Events	104
Editing the Channel Data	113
Editing Voices	85
EFFECT	89
Effect Block	120
Effect Structure	121
Effects	119
EG	88
Embellish and enhance your melodies	
— with the automatic Harmony and Echo effects	29
END Mark	98
ENDING	66
[ENDING / rit.] button	18, 30, 65
[ENTER] button	18, 46
Entering Characters	45
Entering Chords and Sections (Chord Step)	97
Entering miscellaneous characters (marks)	45
Entering numbers	45
Entering special character marks	
(umlaut, accent, Japanese “ゝ” and “ゝ”)	45
Entering Your Name and Language Preference	140
Equal Temperament	125
ESEQ	148
Example Keyboard Data	146
[EXIT] button	18, 40
exit from small pop-up windows	40
[EXTRA TRACKS (STYLE)] button	18, 77

F

Fade In Time, Fade Out Time, Fade Out Hold Time	137
[FADE IN / OUT] button	18, 65
FAVORITE	71
[FF] button	18, 76
File	39
File/Folder-related Operations	41
Files/folders in a floppy disk	42
Fill	66
Filter	88, 105, 118
FINGERED	62
FINGERED ON BASS	62
First Key On	99
FLOPPY DISK drive	39
Floppy disk drive	18, 6
Foot Controller	58, 143
Footswitch	58, 143
Formatting a Disk	139
[FREEZE] button	19, 84, 131
FULL KEYBOARD	62
[FUNCTION] button	18, 122

G

Gate Time	95
GENRE	70, 72
GENRE NAME	72
GM System Level 1	19, 149
Groove	111
Groove parameters	111

H

Handling the Floppy Disk Drive (FDD) and Floppy Disk	6
Harmonic Content	88
HARMONY	58, 89, 132
Harmony Assignments	133
Harmony Types	133
[HARMONY / ECHO] button	18, 58
Headphones	17, 141
Help messages can be displayed in any one of the	
following languages	49
[HELP] button	18, 49
High Key	115
[HOST SELECT] switch	19, 143
Hz	124

I

ICON SELECT	46
[INPUT VOLUME] knob	19, 141
Inputting and Editing Lyrics	105
Instant Selection of Displays	47
INTRO	66
[INTRO] button	18, 31, 64

K

KEY SIGNATURE	79
Keyboard Percussion	55
Keyboard stand (assembly)	150
Keyboard Touch	130
Keyboard/Panel	130
KEYWORD	70, 71
Kirnberger	125

L

Layer	56
Layering Two Different Voices	56
LCD	15
[LCD CONTRAST] knob	18, 17
Left	57
LEFT CH.	79
[LEFT HOLD] button	18, 58
Left pedal	19, 58
Live!	55
Local Control	134
Loop recording	106
Lyrics	81, 105

M

MAIN A/B/C/D	64
MAIN [A] button	18, 64
MAIN [B] button	18, 64
MAIN [C] button	18, 64
MAIN [D] button	18, 64
Maintaining Panel Settings	131
Making Global and Other Important Settings	122
Making Overall System Settings (Local Control, Clock, etc.)	134
Making Settings for Fade In/Out, Metronome,	
Parameter Lock, and Tap	137
Making Settings for the Display, Speaker System,	
and Voice Number Indication	138
Making Settings for the Pedals	128
Making Settings for the Pedals and Keyboard	128
Making Style File Format Settings	114
Master Tune	124
[MASTER VOLUME] dial	18, 17
Mean-Tone	125

- Measure/Beat/Clock 95
 [MEMORY] button 19, 82
 Message Switch 135
 Messages 8
 Metronome 137
 METRONOME [START / STOP] button 18, 50
 [MIC LINE] switch 19, 141
 [MIC / LINE IN] jack 19, 141
 MIDI 134
 MIDI [THRU] [OUT] [IN] terminals 19, 143
 MIDI channels 147
 MIDI IN 143
 MIDI OUT 143
 MIDI Receive Parts 136
 MIDI SET UP 140
 MIDI terminals 143
 MIDI THRU 143
 Mix 101
 [MIXING CONSOLE] button 18, 116
 [MONO] button 18, 58
 Moving Files/Folders 42
 MULTI FINGER 62
 Multi Recording 92
 [MUSIC FINDER] button 15, 18, 33, 69
 Music Finder Record Edit 71
 Music Finder Search 70
 Music rest 16
 Muting Specific Parts 77
- N**
- NAME 41
 Naming Files/Folders 41
 Natural Voices 86
 Natural! 55
 NEW (FOLDER) 44
 NEW RECORD 72
 [NEXT] button 18, 40, 46
 Normal 99
 Note Events 103
 Note for Windows users (regarding MIDI driver) 143
 Note Limit 115
 NOTE NAME 80
 NTR (Note Transposition Rule) 114
 NTT (Note Transposition Table) 115
- O**
- OCTAVE 118
 One Touch Setting 32
 ONE TOUCH SETTING [1] - [4] buttons 19, 67, 68
 One-touch Piano Play 55
 [ON / OFF] button (POWER) 19, 17
 Open/Save displays 38
 Organizing Files by Creating a New Folder 44
 Other Parameters in the Basic Display 109
 Other Playback-related Operations 76
 Other Settings 137
 [OTS LINK] button 18, 68
 Outputting the sound of an external device through the built-in speakers of the PF-1000 142
 Overdub recording 106
 Owner 140
- P**
- Pad 92
 Parameter 114
 Parameter Lock 138
 PASTE 42, 43
 Pedal 128
 Pedal (Center) 58
 Pedal (Left) 58
 Pedal (Right) 58
 [PEDAL] jack 19
 Pedal unit 16
 Pedal-controllable Functions 129
 [PHONES] jacks 19, 141
 Phrase 92
 Phrase Mark 76, 126
 [PIANO] button 15, 19, 55
 PIANO (SOUND CREATOR) 87
 Piano Lock function 55
 PITCH BEND RANGE 118
 Pitch settings for each scale 125
 Playback of Songs 21
 Playing a style 28, 59
 Playing a Style's Rhythm Channels only 61
 Playing Along with the PF-1000 36
 Playing and Practicing with the Songs 36
 Playing Back Songs on Disk 76
 Playing Different Voices with the Left and Right Hands 27
 Playing Fill-in patterns automatically when changing
 accompaniment sections 66
 Playing Several Sounds Simultaneously 56
 Playing Styles 28
 Playing the Demos 20, 52
 Playing the Internal Songs 74
 Playing the sounds of the PF-1000 through an external
 audio system, and recording the sounds to an external
 recorder 142
 Playing Two Voices Simultaneously 26
 Playing Voices 25
 PORTAMENTO TIME 118
 PRESET drive 39
 Preset MIDI Templates 134
 Punch In/Out 99
 Pure Major 125
 Pure Minor 125
 Pythagorean 125
- Q**
- QUANTIZE 79
 Quantize 100, 113
 Quantize Size 100
 Quick Recording 91
 Quick Start 126
- R**
- Realtime Recording 108
 Realtime Recording Characteristics 106
 [REC] button 18, 90
 Rec Mode 99
 Recalling a Registration Memory Setup 84
 Recalling the Registered Settings 84
 Receive 136
 Receive Transpose 135
 Receiving MIDI Data 136
 record 69
 Recording 37
 Recording Chord Changes for the Auto Accompaniment 97
 Recording Individual Notes 94
 Recording Melodies 96
 Recording Your Performances and Creating Songs 90
 Registering Panel Setups 82

Registering the Panel Controls in One Touch Setting	68
REGISTRATION BANK	83
REGISTRATION EDIT display	83
Registration Memory	82
REGISTRATION MEMORY [1] – [8] buttons	19, 82
Registration Sequence	131
Regular Voices	86
RELEASE	88
Remove Event	113
Repeat Playback of a Specific Range	77
[REPEAT] button	18, 77
Replace	71
Resonance	88
Restoring the Factory-programmed Settings	
of the PF-1000	140
[REVERB] button	18, 57
Reverb	121
[REW] button	18, 76
Rhythm	92
RIGHT CH.	79
Root	136
RTR (Retrigger Rule)	115

S

SAVE	44
Save	38, 44
Saving Files	44
Saving Your Registration Memory Setups	83
Scale	125
Scale Tune	124
Score	78
Searching the Ideal Setups	70
Searching the Music Finder Records	34
Section button indications — [BREAK], [INTRO], [MAIN], [ENDING] buttons	64
sections	30
Select the Recording Options: Starting, Stopping, Punching In/Out	99
Selecting a Scale	124
Selecting a Voice	54
Selecting Files and Folders	40
Selecting Intro and Ending Types	66
Selecting items	46
Selecting the Freeze Settings	84
Sequence Format	148
sequencer	146
Set Up	102
Setting Auto Accompaniment-related Parameters	127
Setting Chord Channels	136
Setting Harmony and Echo	132
Setting Root Note Channels	136
Setting Separate Voices for the Left and Right Sections	
of the Keyboard	57
Setting Song-related Parameters	126
Setting the Fingering Method	128
Setting the Level Balance and Voice	117
Setting the MIDI Parameters	134
Setting the Registration Sequence, Freeze, and Voice Set	131
Setting the volume	17
SFX	55
Showing the PF-1000 Display on a TV	133, 142
Simultaneously Playing a Song and an Accompaniment Style	75
SINGLE FINGER	62
SMF (Standard MIDI File)	148
Song	14, 73
SONG [START / STOP] button	18, 74
SONG AUTO REVOICE	117

Song Book	22, 73
Song Creator	90
Song Playback	21, 73, 74
Song Recording	90
Song Settings	126
Sostenuto pedal	19, 58
SOUND (SOUND CREATOR)	87
SOUND CREATOR Parameters	86
[SOUND CREATOR] button	18, 85
Source Root/Chord	114
Specifying the Order for Calling Up Registration Memory	
Presets	131
SPEED	88
Split Point	127
Step Record	94
Step Record (Chord)	97
Step Record (Note)	96
Step Recording	109
Stopping the Style Playback While Releasing Keys	65
Style	14, 59
STYLE buttons	18, 28, 59
STYLE CONTROL [START / STOP] button	18, 28, 60
Style Creator	106
Style File	19, 148
Style File Format	107
Style Sections	30
Style Setting	127
sustain	88
Sweet!	55
[SYNC.START] button	18, 60
[SYNC.STOP] button	18, 65
SYS/EX. (System Exclusive)	104
System	134
System Events	104
System Messages	147
System Reset	140
SYSTEM SET UP	140

T

Tap Count	138
[TAP TEMPO] button	18, 51
TEMPO [-] [+] buttons	18, 50
TEMPO FROM	70
Tempo Indications — MAIN Display	51
TEMPO TO	70
[TO HOST] terminal	15, 19, 143, 144
[TOP] button	18, 76
[TRACK 1 (R)] button	18, 77
[TRACK 2 (L)] button	18, 77
Transmit	135
Transmit Clock	135
Transmitting MIDI Data	135
TRANSPOSE [-] [+] buttons	18, 130
Transpose Assign	130
Tune	118
TUNING	118
Tuning the Overall Pitch	124

U

UP	44
USER drive	39
USER EFFECT	120, 140
Using the USB terminal on your computer	
with a USB/MIDI interface	145
Using Your PF-1000 with Other Devices	141
Utility	137

V

[VARIATION] button	18, 57
Velocity	95, 112
Velocity Change	113
VIBRATO	88
[VIDEO OUT] jack	19, 133, 142
Voice Allocation Format	149
VOICE buttons	15, 19, 54
Voice Characteristics	55
Voice Effects	57
VOICE PART ON / OFF [LAYER] button	18, 56
VOICE PART ON / OFF [LEFT] button	18, 56
Voice Set	132
Volume/Voice	117

W

Werckmeister	125
What You Can Do With MIDI	147
What's MIDI?	145

X

XF	19, 148
XG	19, 149

IMPORTANT SAFETY INSTRUCTIONS

INFORMATION RELATING TO PERSONAL INJURY, ELECTRICAL SHOCK, AND FIRE HAZARD POSSIBILITIES HAS BEEN INCLUDED IN THIS LIST.

WARNING- When using any electrical or electronic product, basic precautions should always be followed. These precautions include, but are not limited to, the following:

1. Read all Safety Instructions, Installation Instructions, Special Message Section items, and any Assembly Instructions found in this manual **BEFORE** making any connections, including connection to the main supply.
2. **Main Power Supply Verification:** Yamaha products are manufactured specifically for the supply voltage in the area where they are to be sold. If you should move, or if any doubt exists about the supply voltage in your area, please contact your dealer for supply voltage verification and (if applicable) instructions. The required supply voltage is printed on the name plate. For name plate location, please refer to the graphic found in the Special Message Section of this manual.
3. This product may be equipped with a polarized plug (one blade wider than the other). If you are unable to insert the plug into the outlet, turn the plug over and try again. If the problem persists, contact an electrician to have the obsolete outlet replaced. Do **NOT** defeat the safety purpose of the plug.
4. Some electronic products utilize external power supplies or adapters. Do **NOT** connect this type of product to any power supply or adapter other than one described in the owners manual, on the name plate, or specifically recommended by Yamaha.
5. **WARNING:** Do not place this product or any other objects on the power cord or place it in a position where anyone could walk on, trip over, or roll anything over power or connecting cords of any kind. The use of an extension cord is not recommended! If you must use an extension cord, the minimum wire size for a 25' cord (or less) is 18 AWG. **NOTE:** The smaller the AWG number, the larger the current handling capacity. For longer extension cords, consult a local electrician.
6. **Ventilation:** Electronic products, unless specifically designed for enclosed installations, should be placed in locations that do not interfere with proper ventilation. If instructions for enclosed installations are not provided, it must be assumed that unobstructed ventilation is required.
7. **Temperature considerations:** Electronic products should be installed in locations that do not significantly contribute to their operating temperature. Placement of this product close to heat sources such as; radiators, heat registers and other devices that produce heat should be avoided.
8. This product was **NOT** designed for use in wet/damp locations and should not be used near water or exposed to rain. Examples of wet/damp locations are; near a swimming pool, spa, tub, sink, or wet basement.
9. This product should be used only with the components supplied or; a cart, rack, or stand that is recommended by the manufacturer. If a cart, rack, or stand is used, please observe all safety markings and instructions that accompany the accessory product.
10. The power supply cord (plug) should be disconnected from the outlet when electronic products are to be left unused for extended periods of time. Cords should also be disconnected when there is a high probability of lightning and/or electrical storm activity.
11. Care should be taken that objects do not fall and liquids are not spilled into the enclosure through any openings that may exist.
12. Electrical/electronic products should be serviced by a qualified service person when:
 - a. The power supply cord has been damaged; or
 - b. Objects have fallen, been inserted, or liquids have been spilled into the enclosure through openings; or
 - c. The product has been exposed to rain; or
 - d. The product does not operate, exhibits a marked change in performance; or
 - e. The product has been dropped, or the enclosure of the product has been damaged.
13. Do not attempt to service this product beyond that described in the user-maintenance instructions. All other servicing should be referred to qualified service personnel.
14. This product, either alone or in combination with an amplifier and headphones or speaker/s, may be capable of producing sound levels that could cause permanent hearing loss. **DO NOT** operate for a long period of time at a high volume level or at a level that is uncomfortable. If you experience any hearing loss or ringing in the ears, you should consult an audiologist. **IMPORTANT:** The louder the sound, the shorter the time period before damage occurs.
15. Some Yamaha products may have benches and/or accessory mounting fixtures that are either supplied as a part of the product or as optional accessories. Some of these items are designed to be dealer assembled or installed. Please make sure that benches are stable and any optional fixtures (where applicable) are well secured **BEFORE** using. Benches supplied by Yamaha are designed for seating only. No other uses are recommended.

PLEASE KEEP THIS MANUAL

FCC INFORMATION (U.S.A.)

1. **IMPORTANT NOTICE: DO NOT MODIFY THIS UNIT!**

This product, when installed as indicated in the instructions contained in this manual, meets FCC requirements. Modifications not expressly approved by Yamaha may void your authority, granted by the FCC, to use the product.

2. **IMPORTANT:** When connecting this product to accessories and/or another product use only high quality shielded cables. Cable/s supplied with this product **MUST** be used. Follow all installation instructions. Failure to follow instructions could void your FCC authorization to use this product in the USA.
3. **NOTE:** This product has been tested and found to comply with the requirements listed in FCC Regulations, Part 15 for Class "B" digital devices. Compliance with these requirements provides a reasonable level of assurance that your use of this product in a residential environment will not result in harmful interference with other electronic devices. This equipment generates/uses radio frequencies and, if not installed and used according to the instructions found in the users manual, may cause interference harmful to the operation of

other electronic devices. Compliance with FCC regulations does not guarantee that interference will not occur in all installations. If this product is found to be the source of interference, which can be determined by turning the unit "OFF" and "ON", please try to eliminate the problem by using one of the following measures:

Relocate either this product or the device that is being affected by the interference.

Utilize power outlets that are on different branch (circuit breaker or fuse) circuits or install AC line filter/s.

In the case of radio or TV interference, relocate/reorient the antenna. If the antenna lead-in is 300 ohm ribbon lead, change the lead-in to co-axial type cable.

If these corrective measures do not produce satisfactory results, please contact the local retailer authorized to distribute this type of product. If you can not locate the appropriate retailer, please contact Yamaha Corporation of America, Electronic Service Division, 6600 Orangethorpe Ave, Buena Park, CA90620

The above statements apply **ONLY** to those products distributed by Yamaha Corporation of America or its subsidiaries.

* This applies only to products distributed by YAMAHA CORPORATION OF AMERICA.

(class B)

IMPORTANT NOTICE FOR THE UNITED KINGDOM

Connecting the Plug and Cord

IMPORTANT. The wires in this mains lead are coloured in accordance with the following code:

BLUE : NEUTRAL
BROWN : LIVE

As the colours of the wires in the mains lead of this apparatus may not correspond with the coloured markings identifying the terminals in your plug proceed as follows:

The wire which is coloured BLUE must be connected to the terminal which is marked with the letter N or coloured BLACK.

The wire which is coloured BROWN must be connected to the terminal which is marked with the letter L or coloured RED.

Making sure that neither core is connected to the earth terminal of the three pin plug.

(2 wires)

- This applies only to products distributed by Yamaha-Kemble Music (U.K.) Ltd.

CAUTION: TO PREVENT ELECTRIC SHOCK, MATCH WIDE BLADE OF PLUG TO WIDE SLOT, FULLY INSERT.

ATTENTION: POUR ÉVITER LES CHOCS ÉLECTRIQUES, INTRODUIRE LA LAME LA PLUS LARGE DE LA FICHE DANS LA BORNE CORRESPONDANTE DE LA PRISE ET POUSSER JUSQU'AU FOND.

(polarity)

- This applies only to products distributed by Yamaha Canada Music Ltd.
- Ceci ne s'applique qu'aux produits distribués par Yamaha Canada Musique Ltée.

For details of products, please contact your nearest Yamaha or the authorized distributor listed below.

Pour plus de détails sur les produits, veuillez-vous adresser à Yamaha ou au distributeur le plus proche de vous figurant dans la liste suivante.

Die Einzelheiten zu Produkten sind bei Ihrer unten aufgeführten Niederlassung und bei Yamaha Vertragshändlern in den jeweiligen Bestimmungsländern erhältlich.

Para detalles sobre productos, contacte su tienda Yamaha más cercana o el distribuidor autorizado que se lista debajo.

NORTH AMERICA

CANADA

Yamaha Canada Music Ltd.
135 Milner Avenue, Scarborough, Ontario,
M1S 3R1, Canada
Tel: 416-298-1311

U.S.A.

Yamaha Corporation of America
6600 Orangethorpe Ave., Buena Park, Calif. 90620,
U.S.A.
Tel: 714-522-9011

CENTRAL & SOUTH AMERICA

MEXICO

**Yamaha de Mexico S.A. De C.V.,
Departamento de ventas**
Javier Rojo Gomez No.1149, Col. Gpe Del
Moral, Deleg. Iztapalapa, 09300 Mexico, D.F.
Tel: 686-00-33

BRAZIL

Yamaha Musical do Brasil LTDA.
Av. Rebouças 2636, São Paulo, Brasil
Tel: 011-853-1377

ARGENTINA

Yamaha de Panamá S.A. Sucursal de Argentina
Viamonte 1145 Piso2-B 1053,
Buenos Aires, Argentina
Tel: 1-4371-7021

PANAMA AND OTHER LATIN AMERICAN COUNTRIES/ CARIBBEAN COUNTRIES

Yamaha de Panamá S.A.
Torre Banco General, Piso 7, Urbanización Marbella,
Calle 47 y Aquilino de la Guardia,
Ciudad de Panamá, Panamá
Tel: 507-269-5311

EUROPE

THE UNITED KINGDOM

Yamaha-Kemble Music (U.K.) Ltd.
Sherbourne Drive, Tilbrook, Milton Keynes,
MK7 8BL, England
Tel: 01908-366700

IRELAND

Danfay Ltd.
61D, Sallynoggin Road, Dun Laoghaire, Co. Dublin
Tel: 01-2859177

GERMANY/SWITZERLAND

Yamaha Europa GmbH.
Siemensstraße 22-34, 25462 Rellingen,
F.R. of Germany
Tel: 04101-3030

AUSTRIA

Yamaha Music Austria
Schleiergasse 20, A-1100 Wien Austria
Tel: 01-60203900

THE NETHERLANDS

Yamaha Music Nederland
Kanaalweg 18G, 3526KL, Utrecht, The Netherlands
Tel: 030-2828411

BELGIUM

Yamaha Music Belgium
Keibergh Imperiastraat 8, 1930 Zaventem, Belgium
Tel: 02-7258220

FRANCE

**Yamaha Musique France,
Division Professionnelle**
BP 70-77312 Marne-la-Vallée Cedex 2, France
Tel: 01-64-61-4000

ITALY

**Yamaha Musica Italia S.P.A.,
Combo Division**
Viale Italia 88, 20020 Lainate (Milano), Italy
Tel: 02-935-771

SPAIN/PORTUGAL

Yamaha-Hazen Electronica Musical, S.A.
Ctra. de la Corona km. 17, 200, 28230
Las Rozas (Madrid) Spain
Tel: 91-201-0700

GREECE

Philippe Nakas S.A.
Navarinou Street 13, P.Code 10680, Athens, Greece
Tel: 01-364-7111

SWEDEN

Yamaha Scandinavia AB
J. A. Wettergrens Gata 1
Box 30053
S-400 43 Göteborg, Sweden
Tel: 031 89 34 00

DENMARK

YS Copenhagen Liaison Office
Generatorvej 8B
DK-2730 Herlev, Denmark
Tel: 44 92 49 00

FINLAND

F-Musiikki Oy
Kluuvikatu 6, P.O. Box 260,
SF-00101 Helsinki, Finland
Tel: 09 618511

NORWAY

Norsk filial av Yamaha Scandinavia AB
Grini Næringspark 1
N-1345 Østerås, Norway
Tel: 67 16 77 70

ICELAND

Skeifan HF
Skeifan 17 P.O. Box 8120
IS-128 Reykjavik, Iceland
Tel: 525 5000

OTHER EUROPEAN COUNTRIES

Yamaha Europa GmbH.
Siemensstraße 22-34, 25462 Rellingen,
F.R. of Germany
Tel: 04101-3030

AFRICA

**Yamaha Corporation,
Asia-Pacific Music Marketing Group**
Nakazawa-cho 10-1, Hamamatsu, Japan 430-8650
Tel: 053-460-2312

MIDDLE EAST

TURKEY/CYPRUS

Yamaha Europa GmbH.
Siemensstraße 22-34, 25462 Rellingen,
F.R. of Germany
Tel: 04101-3030

OTHER COUNTRIES

Yamaha Music Gulf FZE
LB21-128 Jebel Ali Freezone
P.O.Box 17328, Dubai, U.A.E.
Tel: 971-4-881-5868

ASIA

HONG KONG

Tom Lee Music Co., Ltd.
11/F., Silvercord Tower 1, 30 Canton Road,
Tsimshatsui, Kowloon, Hong Kong
Tel: 2737-7688

INDONESIA

**PT. Yamaha Music Indonesia (Distributor)
PT. Nusantik**
Gedung Yamaha Music Center, Jalan Jend. Gatot
Subroto Kav. 4, Jakarta 12930, Indonesia
Tel: 21-520-2577

KOREA

Yamaha Music Korea Ltd.
Tong-Yang Securities Bldg. 16F 23-8 Yoido-dong,
Yongdungpo-ku, Seoul, Korea
Tel: 02-3770-0661

MALAYSIA

Yamaha Music Malaysia, Sdn., Bhd.
Lot 8, Jalan Perbandaran, 47301 Kelana Jaya,
Petaling Jaya, Selangor, Malaysia
Tel: 3-703-0900

PHILIPPINES

Yupangco Music Corporation
339 Gil J. Puyat Avenue, P.O. Box 885 MCPO,
Makati, Metro Manila, Philippines
Tel: 819-7551

SINGAPORE

Yamaha Music Asia Pte., Ltd.
11 Ubi Road #06-00, Meiban Industrial Building,
Singapore
Tel: 65-747-4374

TAIWAN

Yamaha KHS Music Co., Ltd.
10F, 150, Tun-Hwa Northroad,
Taipei, Taiwan, R.O.C.
Tel: 02-2713-8999

THAILAND

Siam Music Yamaha Co., Ltd.
121/60-61 RS Tower 17th Floor,
Ratchadaphisek RD., Dindaeng,
Bangkok 10320, Thailand
Tel: 02-641-2951

THE PEOPLE'S REPUBLIC OF CHINA AND OTHER ASIAN COUNTRIES

**Yamaha Corporation,
Asia-Pacific Music Marketing Group**
Nakazawa-cho 10-1, Hamamatsu, Japan 430-8650
Tel: 053-460-2317

OCEANIA

AUSTRALIA

Yamaha Music Australia Pty. Ltd.
Level 1, 99 Queensbridge Street, Southbank, Victo-
ria 3006, Australia
Tel: 3-9693-5111

NEW ZEALAND

Music Houses of N.Z. Ltd.
146/148 Captain Springs Road, Te Papapa,
Auckland, New Zealand
Tel: 9-634-0099

COUNTRIES AND TRUST TERRITORIES IN PACIFIC OCEAN

**Yamaha Corporation,
Asia-Pacific Music Marketing Group**
Nakazawa-cho 10-1, Hamamatsu, Japan 430-8650
Tel: 053-460-2312

HEAD OFFICE Yamaha Corporation, Pro Audio & Digital Musical Instrument Division
Nakazawa-cho 10-1, Hamamatsu, Japan 430-8650
Tel: 053-460-2445



Yamaha Web Site (English only)
www.yamahasyth.com

Yamaha Manual Library
<http://www2.yamaha.co.jp/manual/english/>

This document is printed on recycled chlorine free (ECF) paper with soy ink.

M.D.G., Pro Audio & Digital Musical Instrument Division, Yamaha Corporation
©2002 Yamaha Corporation
V939640 205APAP1.3-01A0 Printed in Japan