

# YAMAHA

# RX-V793

*Natural Sound AV Receiver*

*Récepteur audiovisuel "Son Naturel"*

*Thank you for selecting this YAMAHA AV receiver.*

*Nous vous remercions d'avoir porté votre choix sur ce récepteur audiovisuel YAMAHA.*

**OWNER'S MANUAL  
MODE D'EMPLOI**

# SAFETY INSTRUCTIONS

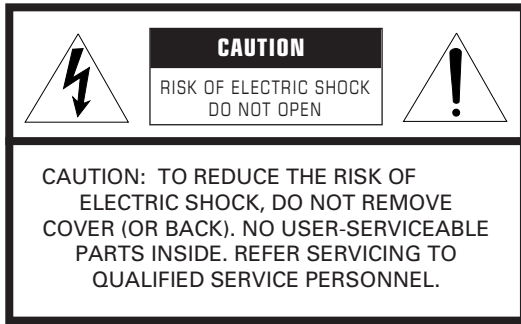

• Explanation of Graphical Symbols

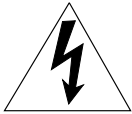

The lightning flash with arrowhead symbol, within an equilateral triangle, is intended to alert you to the presence of uninsulated "dangerous voltage" within the product's enclosure that may be of sufficient magnitude to constitute a risk of electric shock to persons.



The exclamation point within an equilateral triangle is intended to alert you to the presence of important operating and maintenance (servicing) instructions in the literature accompanying the appliance.



- 1 Read Instructions – All the safety and operating instructions should be read before the unit is operated.
- 2 Retain Instructions – The safety and operating instructions should be retained for future reference.
- 3 Heed Warnings – All warnings on the unit and in the operating instructions should be adhered to.
- 4 Follow Instructions – All operating and other instructions should be followed.
- 5 Water and Moisture – The unit should not be used near water – for example, near a bathtub, washbowl, kitchen sink, laundry tub, in a wet basement, or near a swimming pool, etc.
- 6 Carts and Stands – The unit should be used only with a cart or stand that is recommended by the manufacturer.
- 6A A unit and cart combination should be moved with care. Quick stops, excessive force, and uneven surfaces may cause the unit and cart combination to overturn. 
- 7 Wall or Ceiling Mounting – The unit should be mounted to a wall or ceiling only as recommended by the manufacturer.
- 8 Ventilation – The unit should be situated so that its location or position does not interfere with its proper ventilation. For example, the unit should not be situated on a bed, sofa, rug, or similar surface, that may block the ventilation openings; or placed in a built-in installation, such as a bookcase or cabinet that may impede the flow of air through the ventilation openings.
- 9 Heat – The unit should be situated away from heat sources such as radiators, stoves, or other appliances that produce heat.
- 10 Power Sources – The unit should be connected to a power supply only of the type described in the operating instructions or as marked on the unit.
- 11 Power-Cord Protection – Power-supply cords should be routed so that they are not likely to be walked on or pinched by items placed upon or against them, paying particular attention to cords at plugs, convenience receptacles, and the point where they exit from the unit.
- 12 Cleaning – The unit should be cleaned only as recommended by the manufacturer.
- 13 Nonuse Periods – The power cord of the unit should be unplugged from the outlet when left unused for a long period of time.
- 14 Object and Liquid Entry – Care should be taken so that objects do not fall into and liquids are not spilled into the inside of the unit.
- 15 Damage Requiring Service – The unit should be serviced by qualified service personnel when:
  - A. The power-supply cord or the plug has been damaged; or
  - B. Objects have fallen, or liquid has been spilled into the unit; or
  - C. The unit has been exposed to rain; or
  - D. The unit does not appear to operate normally or exhibits a marked change in performance; or
  - E. The unit has been dropped, or the cabinet damaged.
- 16 Servicing – The user should not attempt to service the unit beyond those means described in the operating instructions. All other servicing should be referred to qualified service personnel.
- 17 Power Lines – An outdoor antenna should be located away from power lines.
- 18 Grounding or Polarization – Precautions should be taken so that the grounding or polarization is not defeated.

**19 For US customers only:**

**Outdoor Antenna Grounding** – If an outside antenna is connected to this unit, be sure the antenna system is grounded so as to provide some protection against voltage surges and built-up static charges. Article 810 of the National Electrical Code, ANSI/NFPA 70, provides information with regard to proper grounding of the mast and supporting structure, grounding of the lead-in wire to an antenna discharge unit, size of grounding conductors, location of antenna discharge unit, connection to grounding electrodes, and requirements for the grounding electrode.

**Note to CATV system installer:**

This reminder is provided to call the CATV system installer's attention to Article 820-40 of the NEC that provides guidelines for proper grounding and, in particular, specifies that the cable ground shall be connected to the grounding system of the building, as close to the point of cable entry as practical.

**SPECIAL NOTES FOR FCC COMPOSITE DEVICE (for US customers only)**

This device is a composite system. The digital device component may not cause harmful interference.

EXAMPLE OF ANTENNA GROUNDING

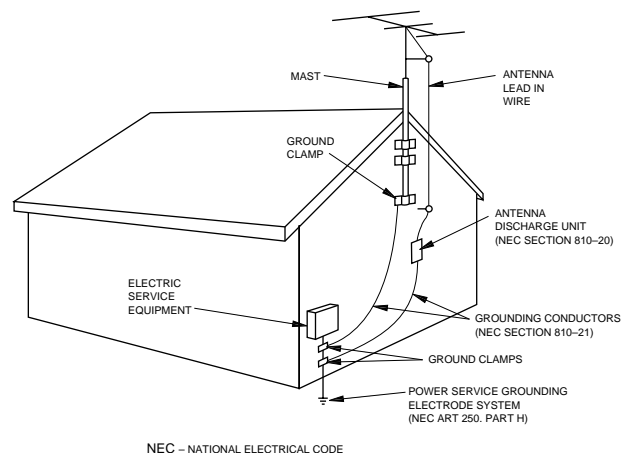
**FCC INFORMATION (for US customers only)****1. IMPORTANT NOTICE : DO NOT MODIFY THIS UNIT!**

This product, when installed as indicated in the instructions contained in this manual, meets FCC requirements. Modifications not expressly approved by Yamaha may void your authority, granted by the FCC, to use the product.

**2. IMPORTANT :** When connecting this product to accessories and/or another product use only high quality shielded cables. Cable/s supplied with this product MUST be used. Follow all installation instructions. Failure to follow instructions could void your FCC authorization to use this product in the USA.**3. NOTE :** This product has been tested and found to comply with the requirements listed in FCC Regulations, Part 15 for Class "B" digital devices. Compliance with these requirements provides a reasonable level of assurance that your use of this product in a residential environment will not result in harmful interference with other electronic devices.

This equipment generates/uses radio frequencies and, if not installed and used according to the instructions found in the users manual, may cause interference harmful to the operation of other electronic devices.

Compliance with FCC regulations does not guarantee that interference will not occur in all installations. If this product is found to be the source of interference, which can be determined by turning the unit "OFF" and "ON", please try to eliminate the problem by using one of the following measures:

Relocate either this product or the device that is being affected by the interference.

Utilize power outlets that are on different branch (circuit breaker or fuse) circuits or install AC line filter/s.

In the case of radio or TV interference, relocate/reorient the antenna. If the antenna lead-in is 300 ohm ribbon lead, change the lead-in to coaxial type cable.

If these corrective measures do not produce satisfactory results, please contact the local retailer authorized to distribute this type of product. If you can not locate the appropriate retailer, please contact Yamaha Electronics Corp., U.S.A. 6660 Orangethorpe Ave, Buena Park, CA 90620.

The above statements apply ONLY to those products distributed by Yamaha Corporation of America or its subsidiaries.

**We Want You Listening For A Lifetime (for US customers only)**

YAMAHA and the Electronic Industries Association's Consumer Electronics Group want you to get the most out of your equipment by playing it at a safe level. One that lets the sound come through loud and clear without annoying blaring or distortion – and, most importantly, without affecting your sensitive hearing.

Since hearing damage from loud sounds is often undetectable until it is too late, YAMAHA and the Electronic Industries Association's Consumer Electronics Group recommend you to avoid prolonged exposure from excessive volume levels.



# CONTENTS

SAFETY INSTRUCTIONS .....	Inside the Front Cover	ADJUSTMENTS IN THE "SET MENU" MODE .....	26
SUPPLIED ACCESSORIES .....	2	BASIC OPERATIONS .....	28
FEATURES .....	3	TUNING OPERATIONS .....	32
CAUTION .....	4	PRESET TUNING .....	33
NOTES ABOUT THE REMOTE CONTROL TRANSMITTER .....	5	USING DIGITAL SOUND FIELD PROCESSOR (DSP) .....	36
PROFILE OF THIS UNIT .....	6	BRIEF OVERVIEW OF DIGITAL SOUND FIELD PROGRAMS .....	40
SPEAKER SETUP .....	8	SETTING THE SLEEP TIMER .....	42
CONNECTIONS .....	10	REMOTE CONTROL TRANSMITTER .....	43
CONTROLS AND THEIR FUNCTIONS .....	19	TROUBLESHOOTING .....	53
ADJUSTMENTS BEFORE USING THIS UNIT .....	22	SPECIFICATIONS .....	55

## SUPPLIED ACCESSORIES

After unpacking, check that the following parts are included.

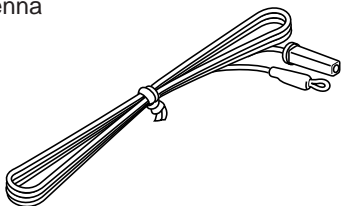
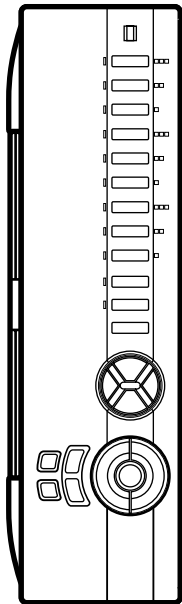
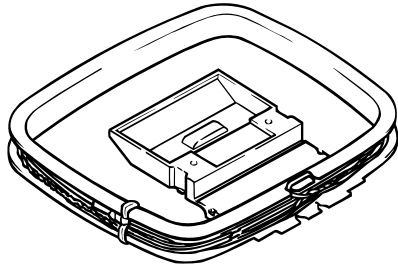
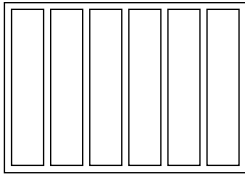
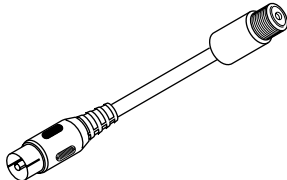
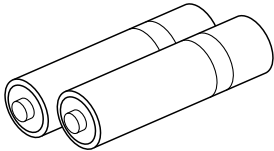
<p>Indoor FM Antenna</p> 	<p>Remote Control Transmitter</p> 
<p>AM Loop Antenna</p> 	<p>User function stickers</p> 
<p>Antenna adapter (U.S.A. and Canada models only)</p> 	
<p>Batteries (size AA, R6, UM-3)</p> 	

## FEATURES

- **5 Speaker Configuration**
  - Main: 80W + 80W (8Ω) RMS Output Power, 0.04% THD, 20–20,000 Hz
  - Center: 80W (8Ω) RMS Output Power, 0.07% THD, 20–20,000 Hz
  - Rear: 80W + 80W (8Ω) RMS Output Power, 0.07% THD, 20–20,000 Hz
- Digital Sound Field Processor
- Dolby Digital (AC-3) Decoder
- Dolby Pro Logic Surround Decoder
- Theater-like Sound Experience by the Combination of Dolby Surround and YAMAHA DSP Technology (CINEMA DSP)
- Automatic Input Balance Control for Dolby Pro Logic Surround
- Test Tone Generator for Easier Speaker Balance Adjustment
- 3 Center Channel Modes (NORMAL/WIDE/PHANTOM)
- BASS EXTENSION Switch for Reinforcing Bass Response
- 40-Station Random Access Preset Tuning
- Automatic Preset Tuning
- Preset Station Shifting Capability (Preset Editing)
- IF Count Direct PLL Synthesizer Tuning System
- Video Signal Input/Output Capability (Including S Video Connections)
- SLEEP Timer
- On Screen Display Function Helpful in Controlling This Unit
- “Learning” Remote Control Transmitter

# CAUTION : READ THIS BEFORE OPERATING YOUR UNIT.

1. To assure the finest performance, please read this manual carefully. Keep it in a safe place for future reference.
2. Install this unit in a cool, dry, clean place – away from windows, heat sources, sources of excessive vibration, dust, moisture and cold. Avoid sources of humming (transformers, motors). To prevent fire or electrical shock, do not expose the unit to rain or water.
3. Never open the cabinet. If something drops into the set, contact your dealer.
4. Do not use force on switches, controls or connection wires. When moving the unit, first disconnect the power plug and the wires connected to other equipment. Never pull the wires themselves.
5. The openings on the cabinet assure proper ventilation of the unit. If these openings are obstructed, the temperature inside the cabinet will rise rapidly. Therefore, avoid placing objects against these openings, and install the unit in well-ventilated condition. Make sure to allow a space of at least 20 cm behind, 20 cm on the both sides and 30 cm above the top panel of the unit. Otherwise it may not only damage the unit, but also cause fire.
6. Always set the VOLUME control to “- ∞” before starting the audio source play. Increase the volume gradually to an appropriate level after playback has been started.
7. Do not attempt to clean the unit with chemical solvents; this might damage the finish. Use a clean, dry cloth.
8. Be sure to read the “TROUBLESHOOTING” section regarding common operating errors before concluding that the unit is faulty.
9. When not planning to use this unit for long periods of time (ie., vacation, etc.), disconnect the AC power plug from the wall outlet.
10. To prevent lightning damage, disconnect the AC power plug and disconnect the antenna cable when there is an electrical storm.
11. Grounding or polarization – Precautions should be taken so that the grounding or polarization of an appliance is not defeated.
12. AC outlet  
Do not connect audio equipment to the AC outlet on the rear panel if that equipment requires more power than the outlet is rated to provide.
13. Voltage Selector (China and General Models only)  
The voltage selector on the rear panel of this unit must be set for your local main voltage BEFORE plugging into the AC main supply.  
Voltages are 110/120/220/240 V AC, 50/60 Hz.

This unit is not disconnected from the AC power source as long as it is connected to the wall outlet, even if this unit itself is turned off. This state is called the standby mode. In this state, this unit is designed to consume a very small quantity of power.

## IMPORTANT

Please record the serial number of this unit in the space below.

Serial No.:

The serial number is located on the rear of the unit. Retain this Owner's Manual in a safe place for future reference.

## WARNING

TO REDUCE THE RISK OF FIRE OR ELECTRIC SHOCK, DO NOT EXPOSE THIS UNIT TO RAIN OR MOISTURE.

## FREQUENCY STEP switch (China and General Models only)

Because the interstation frequency spacing differs in different areas, set the FREQUENCY STEP switch (located at the rear) according to the frequency spacing in your area. Before setting this switch, disconnect the AC power plug of this unit from the AC outlet.

## FOR CANADIAN CUSTOMERS

TO PREVENT ELECTRIC SHOCK, MATCH WIDE BLADE OF PLUG TO WIDE SLOT AND FULLY INSERT.

THIS CLASS B DIGITAL APPARATUS MEETS ALL REQUIREMENTS OF THE CANADIAN INTERFERENCE-CAUSING EQUIPMENT REGULATIONS.

## WARNING

Do not change the IMPEDANCE SELECTOR switch setting while the power to this unit is on, otherwise this unit may be damaged.

## IF THIS UNIT FAILS TO TURN ON WHEN THE STANDBY/ON SWITCH IS PRESSED

The IMPEDANCE SELECTOR switch may not be set to either end closely. If so, set the switch to either end closely.

## IMPEDANCE SELECTOR

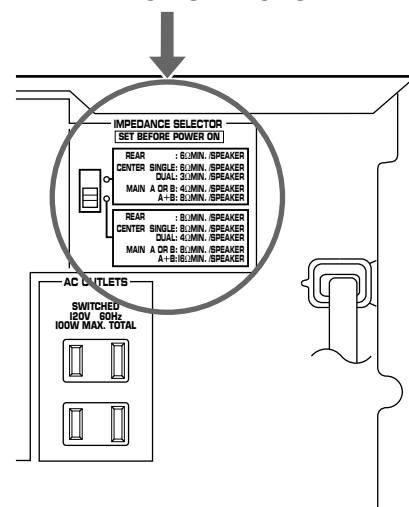

# NOTES ABOUT THE REMOTE CONTROL TRANSMITTER

## Battery installation

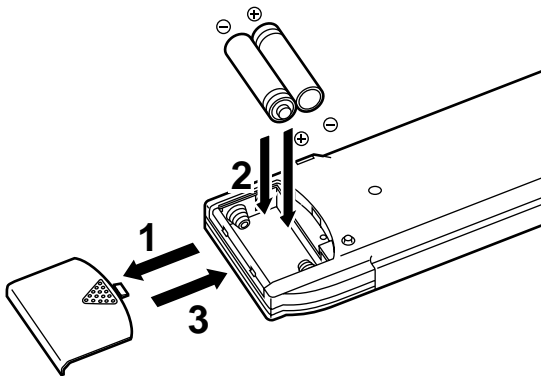

## Remote control transmitter operation range

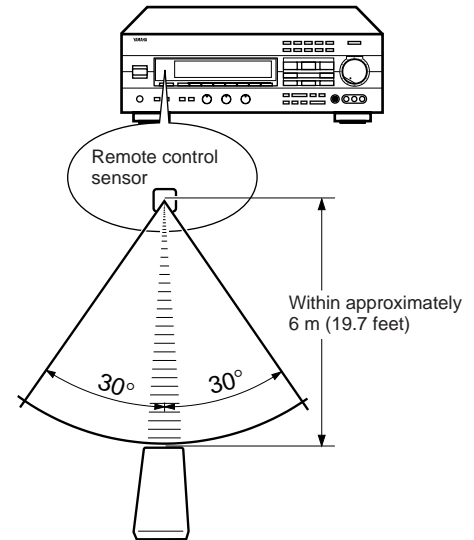

## Battery replacement

If you find that the remote control transmitter must be used closer to the main unit, the batteries are weak. Replace both batteries with new ones.

### Notes

- Use only AA, R6, UM-3 batteries for replacement.
- Be sure the polarities are correct. (See the illustration inside the battery compartment.)
- Remove the batteries if the remote control transmitter will not be used for an extended period of time.
- If batteries leak, dispose of them immediately. Avoid touching the leaked material or letting it come in contact with clothing, etc. Clean the battery compartment thoroughly before installing new batteries.
- After you change batteries, make sure to press the **RESET** button inside the battery compartment.

### Notes

- There should be no large obstacles between the remote control transmitter and the main unit.
- If the remote control sensor is directly illuminated by strong lighting (especially an inverter type of fluorescent lamp etc.), it might cause the remote control transmitter not to work correctly. In this case, reposition the main unit to avoid direct lighting.

# PROFILE OF THIS UNIT

This unit incorporates a sophisticated, multi-program digital sound field processor. The processor allows you to electronically expand and change the shape of the audio sound field from both audio and video sources, creating a theater-like experience in your listening room. This unit has a total of 10 digital sound field processor (DSP) modes. You can create an excellent audio sound field by selecting a suitable sound field (this will, of course, depend on what you will be listening to), and adding desired adjustments.

In addition, this unit incorporates a Dolby Pro Logic Surround decoder and Dolby Digital (AC-3) decoder for multi-channel sound reproduction of Dolby Surround encoded video sources. The operation of the Dolby Pro Logic Surround or Dolby Digital (AC-3) decoder can be controlled by selecting a corresponding DSP program including combined operations of the Yamaha DSP and the Dolby Pro Logic Surround or Dolby Digital (AC-3) decoder.

## Digital Sound Field Processing

---

What is it that makes live music so good? Today's advanced sound reproduction technology lets you get extremely close to the sound of a live performance, but chances are you'll still notice something missing, the acoustic environment of the live concert hall. Extensive research into the exact nature of the sonic reflections that create the ambience of a large hall has made it possible for Yamaha engineers to bring you this same sound in your own listening room, so you'll feel all the sound of a live concert.

Furthermore, our technicians, armed with sophisticated measuring equipment, have even made it possible to capture the acoustics of a variety of actual concert halls, jazz clubs, theaters, etc. from around the world, to allow you to accurately recreate any one of these live performance environments, all in your own home.

## Dolby Pro Logic Surround

---

This unit employs a Dolby Pro Logic Surround decoder similar to professional Dolby Stereo decoders used in many movie theaters. By using the Dolby Pro Logic Surround decoder, you can experience the dramatic realism and impact of Dolby Surround movie theater sound in your own home. Dolby Pro Logic employs a four channel five speaker system. The Pro Logic Surround system divides the input signal into four levels: the left and right main channels, the center channel (used for dialog), and the rear surround sound channels (used for sound effects, background noise, and other ambient noises). The center channel allows listeners seated in even less-than-ideal positions to hear the dialog originating from the action on the screen while experiencing good stereo imaging.

Dolby Surround is encoded on the sound track of pre-recorded video tapes, laser discs, and some TV/cable broadcasts. When you play a source encoded with Dolby Surround on this unit, the Dolby Pro Logic Surround decoder decodes the signal and distributes the surround-sound effects.

This Dolby Pro Logic Surround Decoder employs a digital signal processing system. This system improves the stability of sound at each channel and crosstalk between channels, so that positioning of sounds around the room is more accurate compared with conventional analog signal processing systems.

In addition, this unit features a built-in automatic input balance control. This always assures you the best performance without manual adjustment.

## Dolby Digital (AC-3)

---

The built-in Dolby Digital (AC-3) Decoder leads you into a totally new sound experiences.

Dolby Digital (AC-3) is a new generation of multi-channel digital audio technology, or the newest spatial sound processing format developed for 35 mm film-movies by employing a new kind of low bit-rate audio coding.

Dolby Digital (AC-3) is a digital surround sound system that provides completely independent multi-channel audio to consumers. In multi-channel form, Dolby Digital (AC-3) provides five full range channels in what is sometimes referred to as a "3/2" configuration: three front channels (left, center and right), plus two surround channels. A sixth bass-only effect channel is also provided for output of LFE (low frequency effect), or low bass effects that are independent of other channels. This channel is counted as 0.1, thus giving rise to the term 5.1 channels in total.

Compared to Dolby Pro Logic that is referred to a "3/1" system (left front, center, right front and just one surround channel), Dolby Digital (AC-3) features two surround channels, called stereo or split surrounds, each offering the same full range fidelity as the three front channels.

Sound of wide dynamic range reproduced by the five full range channels presents listeners much excitement that has never been experienced before. Precise sound orientation by the discrete digital sound processing expands realism that the original movie possesses.

Laser Disc and DVD are home audio formats that could benefit from Dolby Digital (AC-3). In the near future, Dolby Digital (AC-3) will also be applied to DBS, CATV and HDTV. The ongoing release of Dolby Stereo Digital theatrical films now underway will provide an immediate source of Dolby Digital (AC-3) encoded video software.





Manufactured under license from Dolby Laboratories Licensing Corporation. "Dolby", "AC-3", "Pro Logic", and the double-D symbol are trademarks of Dolby Laboratories Licensing Corporation.

Copyright 1992 Dolby Laboratories, Inc. All rights reserved.

The following original functions make the surround-sound effect of Dolby Digital (AC-3) become the most suitable for your audio system and the listening conditions.

- **Dynamic range (sound scale) of source can be changed so that it will be suitable for the listening conditions.**
- **Output of low bass from any channel can be assigned to either the MAIN SPEAKERS terminals or SUBWOOFER terminal to maximize system performance.**
- **Output of LFE can be assigned to either the MAIN SPEAKERS terminals or SUBWOOFER terminal to maximize system performance.**

## Dolby Surround + DSP (CINEMA DSP)

Dolby Surround sound system shows its full ability in a large movie theater, because movie sounds are originally designed to be reproduced in a large movie theater using many speakers. It is difficult to create a sound environment similar to that of a movie theater in your listening room, because the room size, materials of inside walls, the number of speakers, etc. of your listening room is much different from those of a movie theater.

Yamaha DSP technology made it possible to present you with nearly the same sound experience as that of a large movie theater in your listening room by compensating for lack of presence and dynamics in your listening room with its original digital sound fields combined with Dolby Surround sound field.

### CINEMA DSP

The YAMAHA "CINEMA DSP" logo indicates those programs are created by the combination of Dolby Surround and YAMAHA DSP technology.

#### Dolby Pro Logic + 2 Digital Sound Fields

Digital sound fields are created on the presence side and the rear surround side of the Dolby Pro Logic Surround-decoded sound field respectively. They create a wide acoustic environment and emphasize surround-effect in the room, letting you feel much presence as if you are watching a movie in a popular Dolby Stereo theater.

This combination is available when the sound field program No. 2, No. 3 or No. 4 is selected, and the input signal of source is analog, PCM audio or encoded with the Dolby Digital (AC-3) in 2-channels.

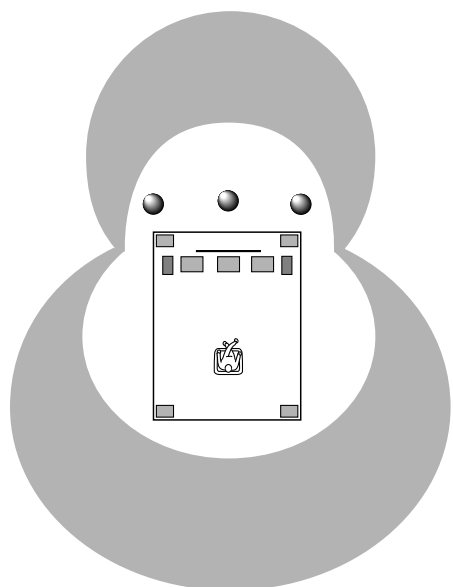

#### Dolby Digital (AC-3) + 3 Digital Sound Fields

Digital sound fields are created on the presence side and the independent left and right surround sides of the Dolby Digital (AC-3)-decoded sound field respectively. They create a wide acoustic environment and much surround effect in the room without losing high channel separation. With wide dynamic range of Dolby Digital (AC-3) sound, this sound field combination lets you feel as if you are watching a movie in the newest Dolby Stereo Digital theater. This will be the most ideal home theater sound at the present time.

This combination is available when the sound field program No. 2, No. 3 or No. 4 is selected, and the input signal of source is encoded with the Dolby Digital (AC-3) (except in 2-channels).

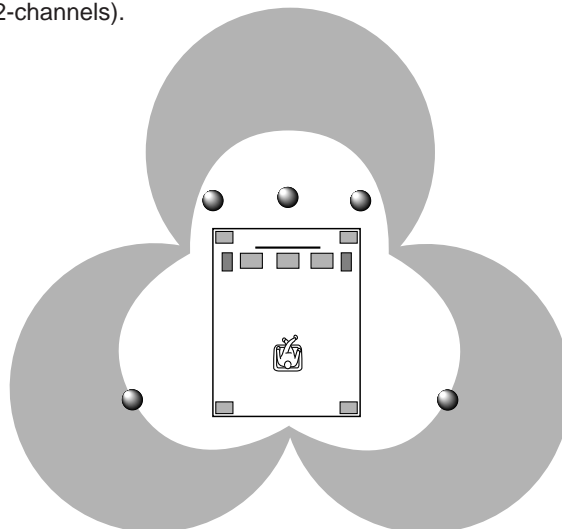

# SPEAKER SETUP

## SPEAKERS TO BE USED

This unit is designed to provide the best sound-field quality with a 5 speaker configuration, using main speakers, rear speakers and a center speaker.

The main speakers are used for the main source sound plus the effect sounds. They will probably be the speakers from your present stereo system. The rear speakers are used for the effect and surround sounds, and the center speaker is for the center sounds (dialog, vocals, etc.). If for some reason it is not practical to use a center speaker, you can do without it. Best results, however, are obtained with the full system.

The main speakers should be high performance models and have enough power handling capacity to accept the maximum output of your audio system.

Other speakers do not have to be equal to the main speakers. For precise sound localization, however, it is ideal to use high performance models that can reproduce sounds in full range for the center speaker and the rear speakers.

### Use of a subwoofer expands your sound field

It is also possible to further expand your system with the addition of a subwoofer and amplifier. The use of a subwoofer is effective not only for reinforcing bass frequencies from any or all channels, but also for reproducing the LFE (low frequency effect) sound with high fidelity when playing back a source with the Dolby Digital (AC-3) decoded. You may wish to choose the convenience of a Yamaha Active Servo Processing Subwoofer System, which has its own built-in power amplifier.

## SPEAKER CONFIGURATION

### 5-Speaker Configuration

This configuration is the most effective and recommended one. When playing back a source using the DSP program, **DIGITAL (PRO LOGIC)**, **DIGITAL (PRO LOGIC) ENHANCED**, **DIGITAL (70 mm) MOVIE THEATER** or **TV SPORTS**, or when playing back a source which contains center-channel signals (dialog, vocals, etc.) using any DSP program with the Dolby Digital (AC-3) decoded, conversations will be output from the center speaker and the ambience will be excellent.

**Note:** Set the CENTER SPEAKER mode to the "NORMAL" or "WIDE" position. (For details, refer to page 22.)

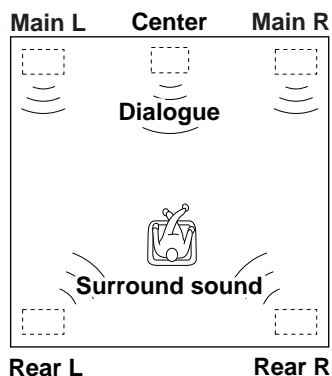

### 4-Speaker Configuration

The center speaker is not used in this configuration. When playing back a source using the DSP program, **DIGITAL (PRO LOGIC)**, **DIGITAL (PRO LOGIC) ENHANCED**, **DIGITAL (70 mm) MOVIE THEATER** or **TV SPORTS**, or when playing back a source which contains center-channel signals (dialog, vocals, etc.) using any DSP program with the Dolby Digital (AC-3) decoded, the center sound is output from the left and the right main speakers. However, the sound effect of other programs can be the same as that of the 5-speaker configuration.

**Note:** Be sure to set the CENTER SPEAKER mode to the "PHANTOM" position. (For details, refer to page 22.)

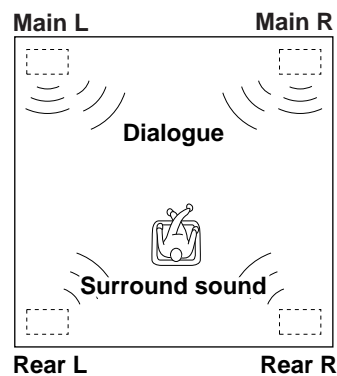

## SPEAKER PLACEMENT

When you place speakers, refer to the following.

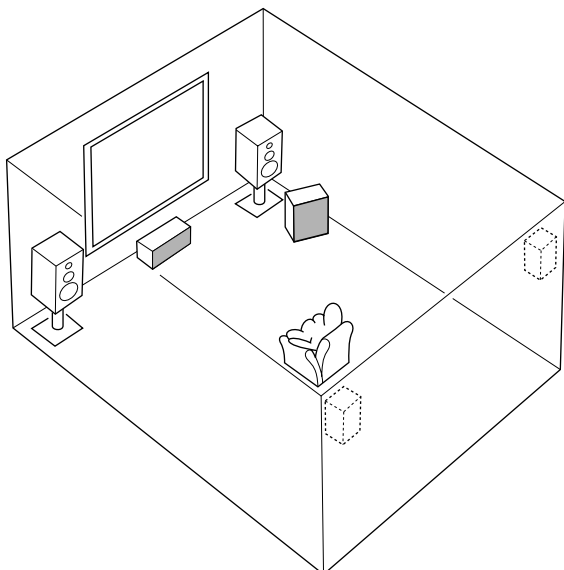

Main speaker



Center speaker



Rear speaker



Subwoofer

- Main:** In normal position. (The position of your present stereo speaker system.)
- Rear:** Behind your listening position, facing slightly inward. Nearly 1.8 m (approx. 6 feet) up from the floor.
- Center:** Precisely between the main speakers. (To avoid interference with TV sets, use a magnetically shielded speaker.)
- Subwoofer:**  
The position of the subwoofer is not so critical because low bass tones are not highly directional.

# CONNECTIONS

Never plug in this unit and other components until all connections are completed.

## CONNECTIONS WITH OTHER COMPONENTS

When making connections between this unit and other components, be sure all connections are made correctly, that is to say L (left) to L, R (right) to R, “+” to “+” and “-” to “-”. Also, refer to the owner’s manual for each component to be connected to this unit.

\* If you have YAMAHA components numbered as 1, 3, 4, etc. on the rear panel, connections can be made easily by making sure to connect the output (or input) terminals of each component to the same-numbered terminals of this unit.

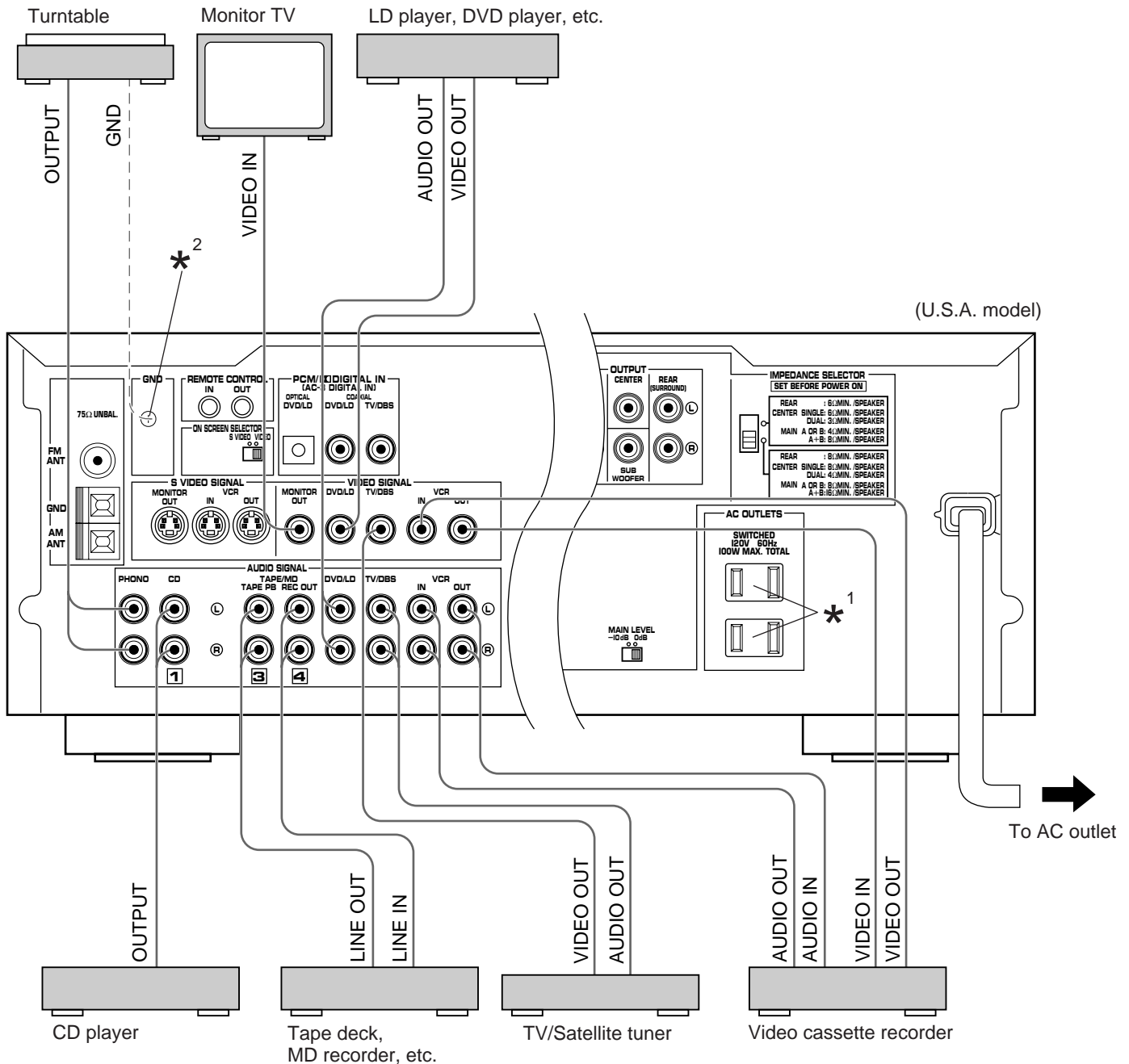

\*<sup>1</sup>, \*<sup>2</sup> : See the next page.

## \*<sup>1</sup> AC OUTLET(S) (SWITCHED)

(U.S.A., Canada, Singapore, China and General models)  
 ..... 2 SWITCHED OUTLETS  
 (Australia model) ..... 1 SWITCHED OUTLET

Use these to connect the power cords from your components to this unit.

The power to the **SWITCHED** outlets is controlled by this unit's **STANDBY/ON** switch or the provided remote control transmitter's **SYSTEM POWER ON** and **STANDBY** keys.

These outlets will supply power to any component whenever this unit is turned on.

The maximum power (total power consumption of components) that can be connected to the **SWITCHED AC OUTLET(S)** is 100 watts.

## \*<sup>2</sup> GND terminal (For turntable use)

Connecting the ground wire of the turntable to the **GND** terminal will normally minimize hum, but in some cases better results may be obtained with the ground wire disconnected.

## ■ CONNECTING TO VIDEO AUX TERMINALS (ON THE FRONT PANEL)

These terminals are used to connect any video input source such as a camcorder to this unit.

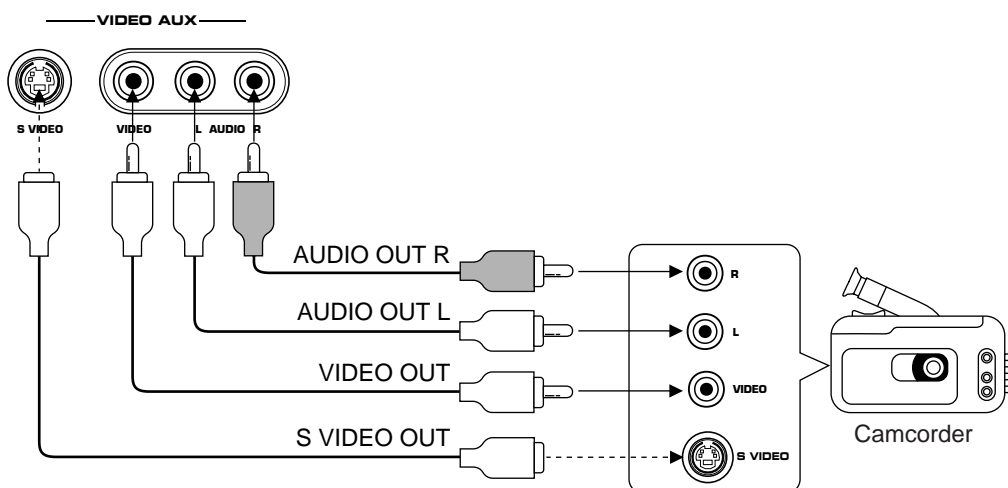

### For Custom Installer For U.S.A., Canada and Australia models only

#### REMOTE CONTROL (IN, OUT) terminals

These terminals are used for custom installation system. When this unit is connected to the components for custom installation system, you can operate this unit with the system remote control.

Connect the **REMOTE CONTROL IN** terminal of this unit to the output terminal of the central controller for custom installation system.

By connecting the **REMOTE CONTROL OUT** terminal of this unit to the REMOTE CONTROL IN terminal of the other component, you can also operate it with the system remote control. In this way, up to 6 components can be connected in series.

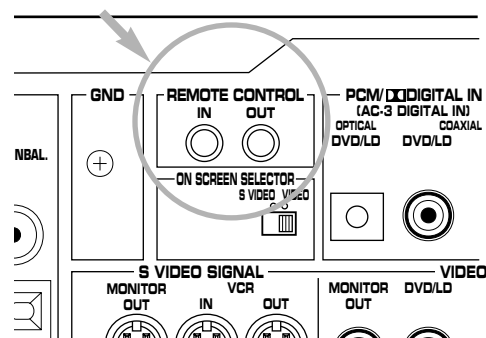

## ■ CONNECTING TO DIGITAL (OPTICAL AND COAXIAL) TERMINALS

If your DVD (LD) player, TV/satellite tuner, etc. are equipped with coaxial or optical digital audio signal output terminals, they can be connected to this unit's COAXIAL and/or OPTICAL digital signal input terminals.

To make a connection between optical digital audio signal terminals, remove the cover from each terminal, and then connect them by using a commercially available optical fiber cable that conforms to EIAJ standards. Other cables might not function correctly.

Even if you connect an audio/video unit to the OPTICAL (or COAXIAL) terminal of this unit, you must keep the unit connected with the same named analog audio signal terminals of this unit, because digital signal cannot be recorded by a tape deck or VCR connected to this unit. You can switch the selection of input signals between "digital" and "analog" easily. (See page 29 for details.)

### Notes

- When connecting an audio/video unit to both of the digital and analog terminals of this unit, make sure to connect to both terminals of the same name.
- Be sure to attach the covers when the OPTICAL terminals are not being used, in order to protect the terminals from dust.
- All digital audio signal input terminals are applicable to the sampling frequency of 32 kHz, 44.1 kHz and 48 kHz.

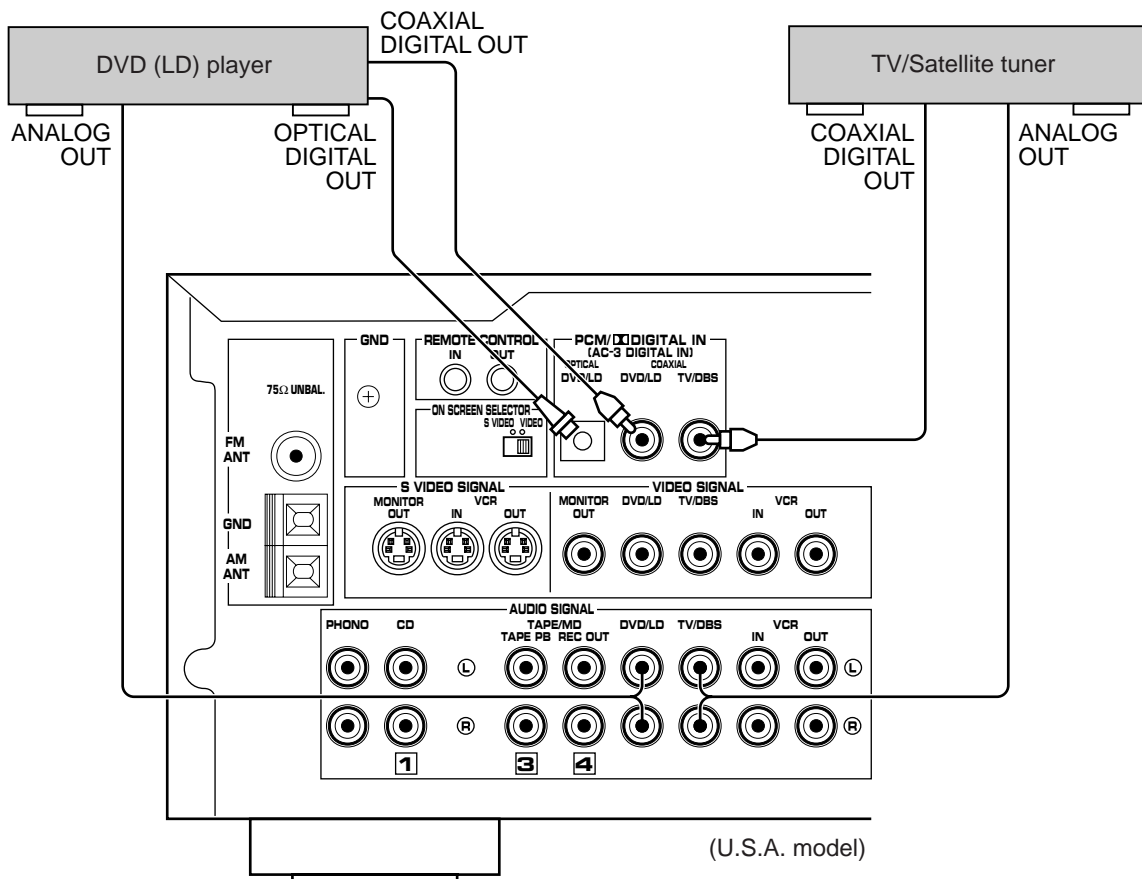

## Notes on connecting with an LD player equipped with an AC-3 RF output

If your LD player has AC-3 RF signal output terminal and no digital signal output terminal for AC-3 discrete audio signals, connect the AC-3 RF signal output terminal to this unit's OPTICAL (or COAXIAL) digital signal input terminal by using an RF demodulator (separate purchase).

First, connect the AC-3 RF signal output terminal of the LD player to the AC-3 RF signal input terminal of the RF demodulator. Next, connect the optical (or coaxial) digital signal output terminal of the RF demodulator to the OPTICAL (or COAXIAL) digital signal input terminal of this unit. This connection is necessary for sending audio signals encoded with the Dolby Digital (AC-3) from the LD player to this unit.

It is also necessary to connect the LD player to this unit's analog audio signal input terminals regardless of the AC-3 RF signal connection, for playing back an LD source with the Dolby Pro Logic Surround decoded or in normal stereo (or monaural).

If desired, you can also connect the digital signal output terminal (for 2-channel audio signals) of the LD player to this unit. If you will do so, connect it to the COAXIAL digital signal input terminal of this unit, and connect the RF demodulator to the OPTICAL digital signal input terminal of this unit.

By this connection, if the input mode of the DVD/LD source is in "AUTO", you can enjoy listening to sounds with the Dolby Digital (AC-3) decoded when you play a disc encoded with the Dolby Digital (AC-3) though signals are input to both OPTICAL and COAXIAL digital signal input terminals of this unit simultaneously (because signals input to the OPTICAL terminal take priority of signals input to the COAXIAL terminal). See page 29 for details about switching the input mode.

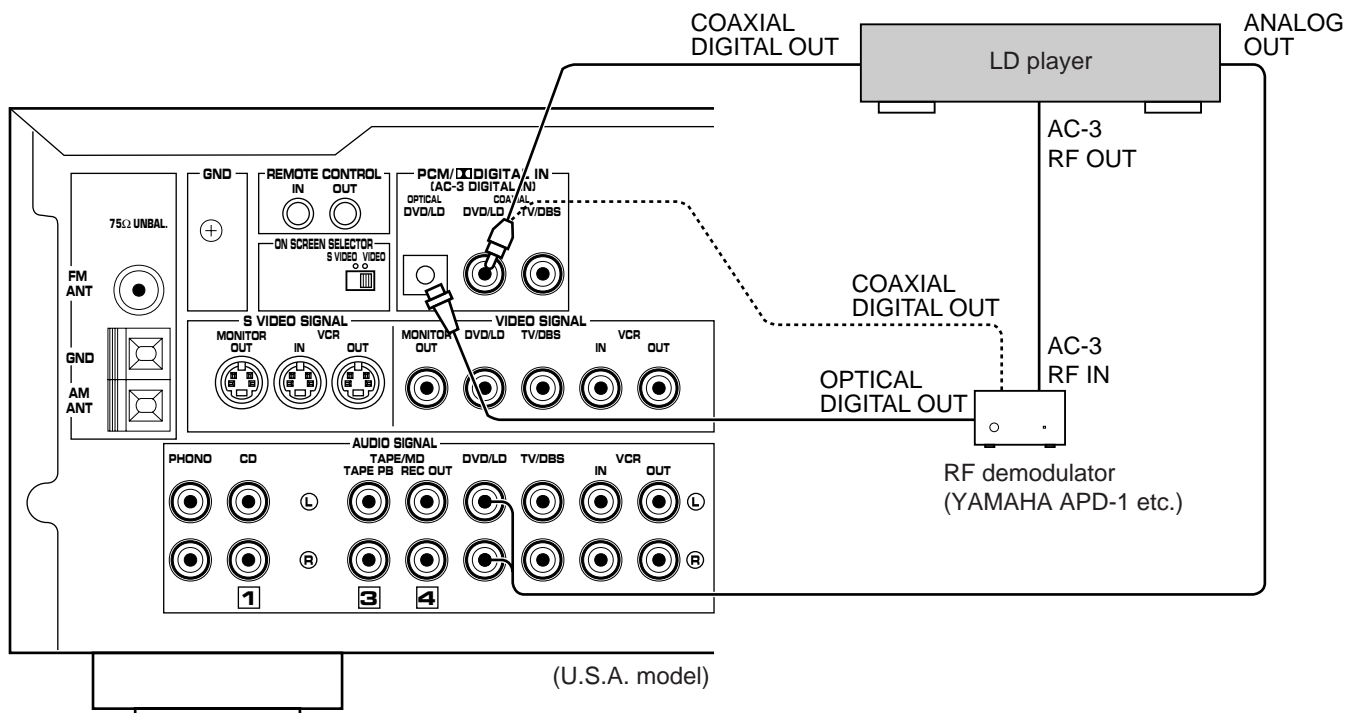

### Notes

- If your LD player has an OPTICAL digital output terminal (for 2-channel audio signals), **be sure not to connect it to this unit's OPTICAL digital input terminal**. If you do so, when you play a disc encoded with the Dolby Digital (AC-3), the Dolby Digital (AC-3) will not be decoded because the 2-channel audio signals input to this unit's OPTICAL digital input terminal are selected prior to the signals encoded with the Dolby Digital (AC-3) input to this unit's COAXIAL digital input terminal by way of an RF demodulator.
- If, for example, you play a CD on the LD player (which can play a CD also), there is no input to the OPTICAL terminal, so the signals input to the COAXIAL terminal take priority. In this case, switch off the RF demodulator to listen to CD sound surely. However, if your RF demodulator is the Yamaha model APD-1, you do not have to switch it off.
- When you want to play a source encoded with the Dolby Digital (AC-3) without decoding the Dolby Digital (AC-3), you must switch off the power to the RF demodulator.

## ■ CONNECTING TO S VIDEO SIGNAL TERMINALS

If you have a video cassette recorder and a monitor equipped with "S" (high-resolution) video terminals, those terminals can be connected to this unit's **S VIDEO SIGNAL** terminals. Connect the video cassette recorder's "S" video input and output terminals to this unit's **S VIDEO SIGNAL VCR IN** and **OUT** terminals respectively, and connect the monitor's "S" video input terminal to this unit's **S VIDEO SIGNAL MONITOR OUT** terminal. Otherwise, connect the video cassette recorder's composite video terminals to this unit's composite video terminals, and connect the monitor's composite video input terminal to this unit's composite **MONITOR OUT** terminal.

### Note

If video signals are sent to both **S VIDEO SIGNAL** input and composite input terminals, the signals will be sent to their respective output terminals.

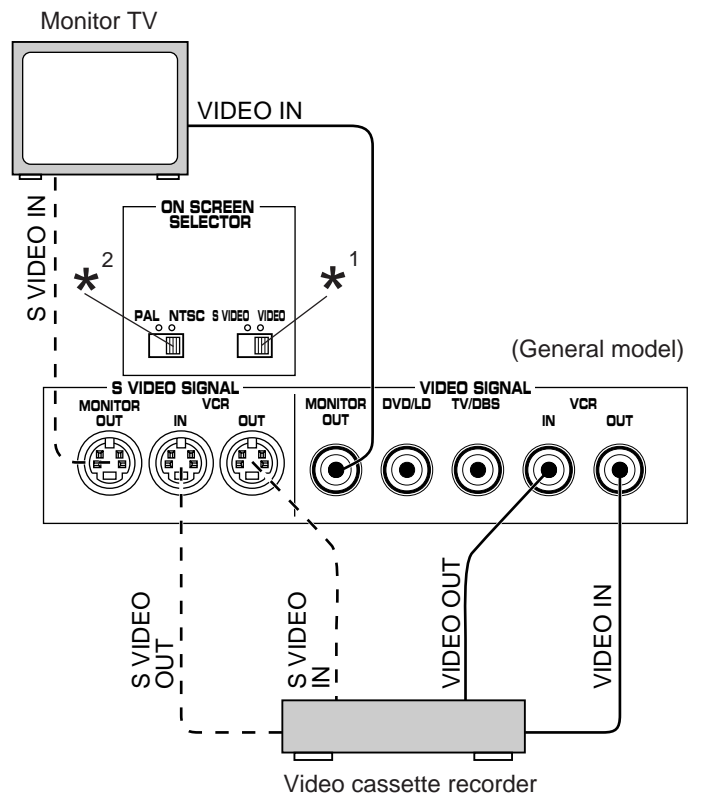

## ON SCREEN DISPLAY

If you connect a video cassette recorder, LD player, video monitor, etc. to this unit, you can display DSP program names and information about other settings and adjustments on the video monitor screen which is connected to the composite **VIDEO SIGNAL** (or **S VIDEO SIGNAL**) **MONITOR OUT** terminal of this unit. Information is superimposed over the video image. If there is no program material on the monitor, the information will be displayed over a monochromatic background.

By using the **ON SCREEN SELECTOR S VIDEO/VIDEO** switch, select the video monitor connected to the **S VIDEO SIGNAL MONITOR OUT** terminal or composite **VIDEO SIGNAL MONITOR OUT** terminal on which you want to display the screen display information.

\*<sup>1</sup>

### ON SCREEN SELECTOR S VIDEO/VIDEO switch

**S VIDEO:** In this position, the screen display information is displayed on the video monitor connected to the **S VIDEO SIGNAL MONITOR OUT** terminal.

**VIDEO:** In this position, the screen display information is displayed on the video monitor connected to the composite **VIDEO SIGNAL MONITOR OUT** terminal.

\*<sup>2</sup>

### PAL/NTSC switch (China and General models only)

This unit is designed for use with the NTSC and PAL television formats. Set this switch to the position for the format your monitor TV employs.

**PAL:** Outputs signals in the PAL format no matter which format (PAL or NTSC) of video signal is sent from an external video unit to this unit. Set to this position if your monitor TV employs the PAL format.

**NTSC:** Outputs signals in the NTSC format no matter which format (PAL or NTSC) of video signal is sent from an external video unit to this unit. Set to this position if your monitor TV employs the NTSC format.

### Note

Make sure to input a video signal which employs the same format that your monitor TV employs, otherwise a picture will not be played back normally.



# CONNECTING SPEAKERS

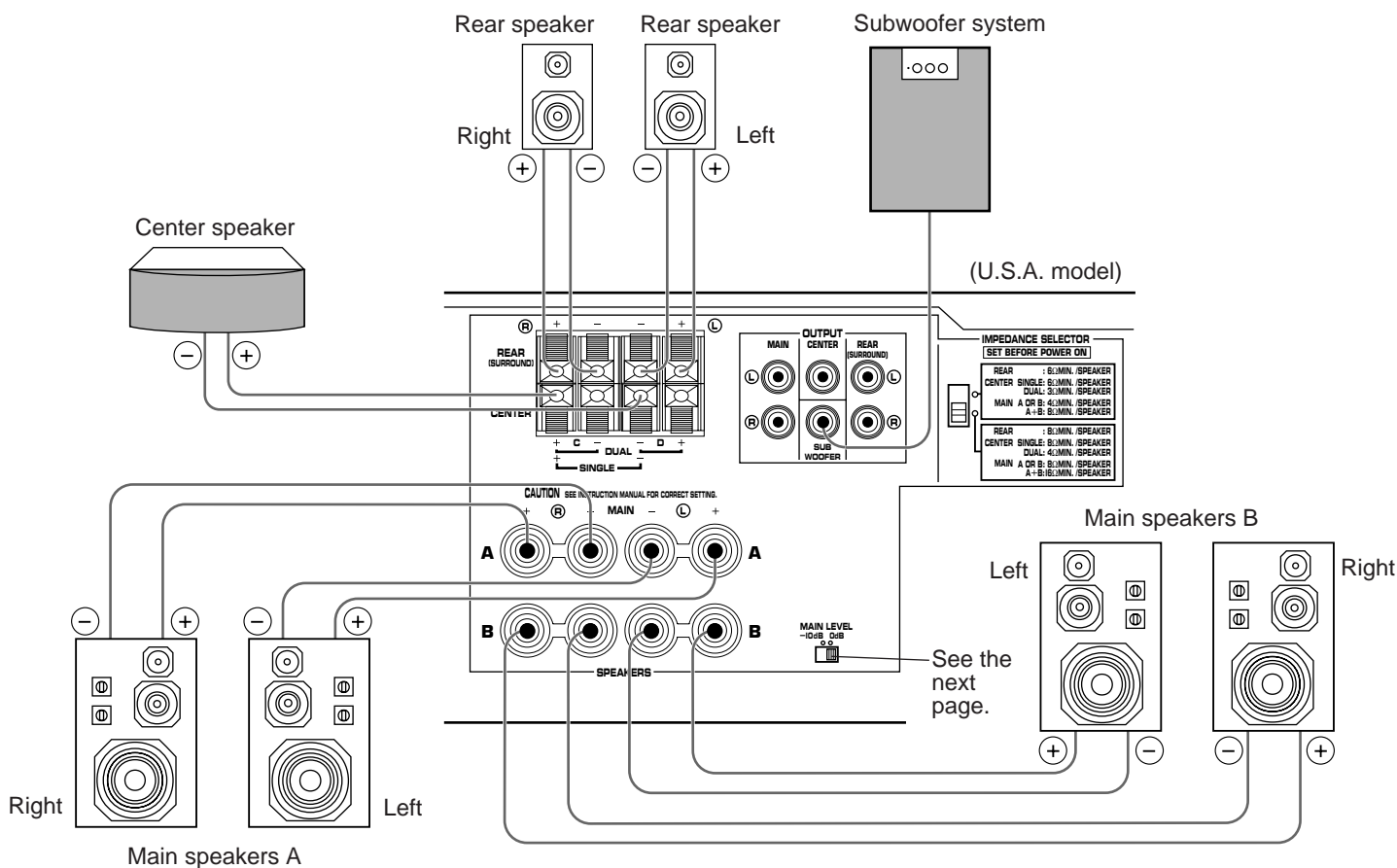

**Note**  
Use speakers with the specified impedance shown on the rear of this unit.

**Note on main speaker connections:**  
One or two speaker systems can be connected to this unit. If you use only one speaker system, connect it to either the **SPEAKERS A** or **B** terminals.

**Note on a subwoofer connection:**  
You may wish to add a subwoofer to reinforce low frequencies or to output low bass sound from the subwoofer channel when reproducing discrete signals. Connect the **SUBWOOFER OUTPUT** terminal of this unit to the **INPUT** terminal of the subwoofer amplifier, and connect the speaker terminals of the subwoofer amplifier to the subwoofer. With some subwoofers, including the Yamaha Active Servo Processing Subwoofer System, the amplifier and subwoofer are in the same unit.

**Note on center speaker connection:**  
One or two center speakers can be connected to this unit. If you cannot place the center speaker on or under the TV, it is recommended to use two center speakers and place them on both sides of the TV to orient the center sound at the center position. For connecting two center speakers, follow the method shown below.

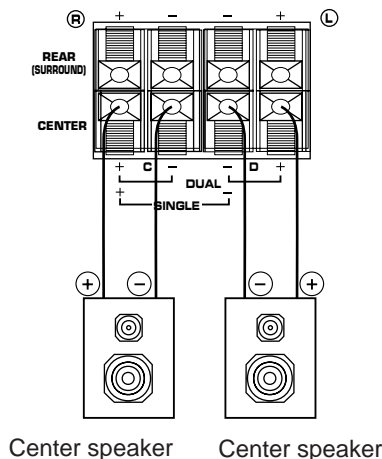

## How to Connect:

Connect the **SPEAKERS** terminals to your speakers with wire of the proper gauge, cut as short as possible. If the connections are faulty, no sound will be heard from the speakers. Make sure that the polarity of the speaker wires is correct, that is the + and – markings are observed. If these wires are reversed, the sound will be unnatural and lack bass.

### Caution

**Do not let the bare speaker wires touch each other and do not let them touch any metal part of this unit. This could damage this unit and/or speakers.**

### For connecting to the MAIN SPEAKERS terminals

Red: positive (+)  
Black: negative (-)

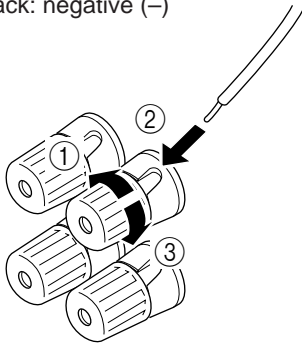

- ① Unscrew the knob.
- ② Insert the bare wire.  
[Remove approx. 5mm (1/4") insulation from the speaker wires.]
- ③ Tighten the knob and secure the wire.

### <U.S.A., Canada, China and General models only>

Banana Plug connections are also possible. Simply insert the Banana Plug connector into the corresponding terminal.

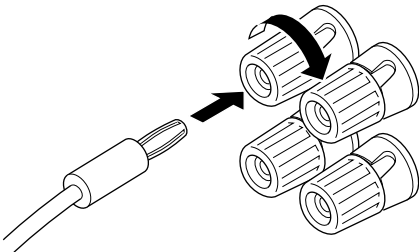

### For connecting to the REAR and CENTER SPEAKERS terminals

Red: positive (+)  
Black: negative (-)

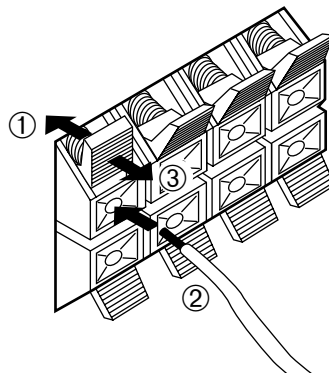

- ① Press the tab.
- ② Insert the bare wire.  
[Remove approx. 5mm (1/4") insulation from the speaker wires.]
- ③ Release the tab and secure the wire.

### MAIN LEVEL switch

Normally set to "0 dB". If desired, you can decrease the output level at the **MAIN SPEAKERS** terminals by 10 dB by setting this switch to "-10 dB".

**MAIN LEVEL**  
-10dB 0dB



## ■ OUTPUT terminals (for driving speakers with external amplifiers)

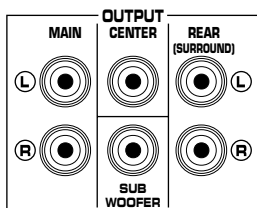

### MAIN OUTPUT terminals

These terminals are for main channel line output. There is no connection to these terminals when you use the built-in amplifier.

However, if you drive main speakers with an external stereo power amplifier, connect the input terminals of the external amplifier (MAIN IN or AUX terminals of a power amplifier or an integrated amplifier) to these terminals.

\* Output signals from the MAIN OUTPUT terminals are affected by the use of **BASS**, **TREBLE**, **BALANCE** controls and **BASS EXTENSION** switch.

### CENTER OUTPUT terminal

This terminal is for center channel line output. There is no connection to this terminal when you use the built-in amplifier. However, if you drive a center speaker with an external power amplifier, connect the input terminal of the external amplifier to this terminal.

### REAR (SURROUND) OUTPUT terminals

These terminals are for rear channel line output. There is no connection to these terminals when you use the built-in amplifier.

However, if you drive rear speakers with an external stereo power amplifier, connect the input terminals of the external amplifier (MAIN IN or AUX terminals of a power amplifier or an integrated amplifier) to these terminals.

### SUBWOOFER OUTPUT terminal

This terminal is for connecting with the input terminal of an amplifier for driving a subwoofer.

When the input signals to this unit are in normal 2-channel stereo, this terminal outputs only frequencies below 150 Hz (200 Hz for General model only) from the main and center channels. When discrete signals are input to this unit and are selected as the input source, this terminal outputs signals from the subwoofer channel.

#### Note

Output level of signals from all of these terminals are adjusted by the use of **VOLUME** control on the front panel or **MASTER VOLUME** keys on the remote control transmitter.

## ■ IMPEDANCE SELECTOR switch

Be sure to switch this only when the power to this unit is not on. Select the position whose requirements your speaker system meets.

#### WARNING

**Do not change the IMPEDANCE SELECTOR switch setting while the power to this unit is on, otherwise this unit may be damaged.**

#### IF THIS UNIT FAILS TO TURN ON WHEN THE STANDBY/ON SWITCH IS PRESSED

The **IMPEDANCE SELECTOR** switch may not be set to either end closely. If so, set the switch to either end closely.

### IMPEDANCE SELECTOR

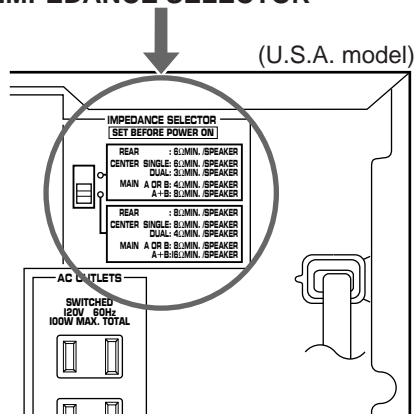

 (Upper position)

**Rear:** The impedance of each speaker must be 6Ω or higher.

**Center:** If you use one center speaker, the impedance of the speaker must be 6Ω or higher.  
If you use two center speakers, the impedance of each speaker must be 3Ω or higher.

**Main:** If you use one pair of main speakers, the impedance of each speaker must be 4Ω or higher.  
If you use two pairs of main speakers, the impedance of each speaker must be 8Ω or higher.

 (Lower position)

**Rear:** The impedance of each speaker must be 8Ω or higher.

**Center:** If you use one center speaker, the impedance of the speaker must be 8Ω or higher.  
If you use two center speakers, the impedance of each speaker must be 4Ω or higher.

#### Main: <Except Canada model>

If you use one pair of main speakers, the impedance of each speaker must be 8Ω or higher.  
If you use two pairs of main speakers, the impedance of each speaker must be 16Ω or higher.

#### <For Canada model only>

The impedance of each speaker must be 8Ω or higher.

# ANTENNA CONNECTIONS

- Each antenna should be connected to the designated terminals correctly, referring to the following diagram.
- Both AM and FM indoor antennas are included with this unit. In general, these antennas will probably provide sufficient signal strength. Nevertheless, a properly installed outdoor antenna will give clearer reception than an indoor one. If you experience poor reception quality, an outdoor antenna may result in improvement.

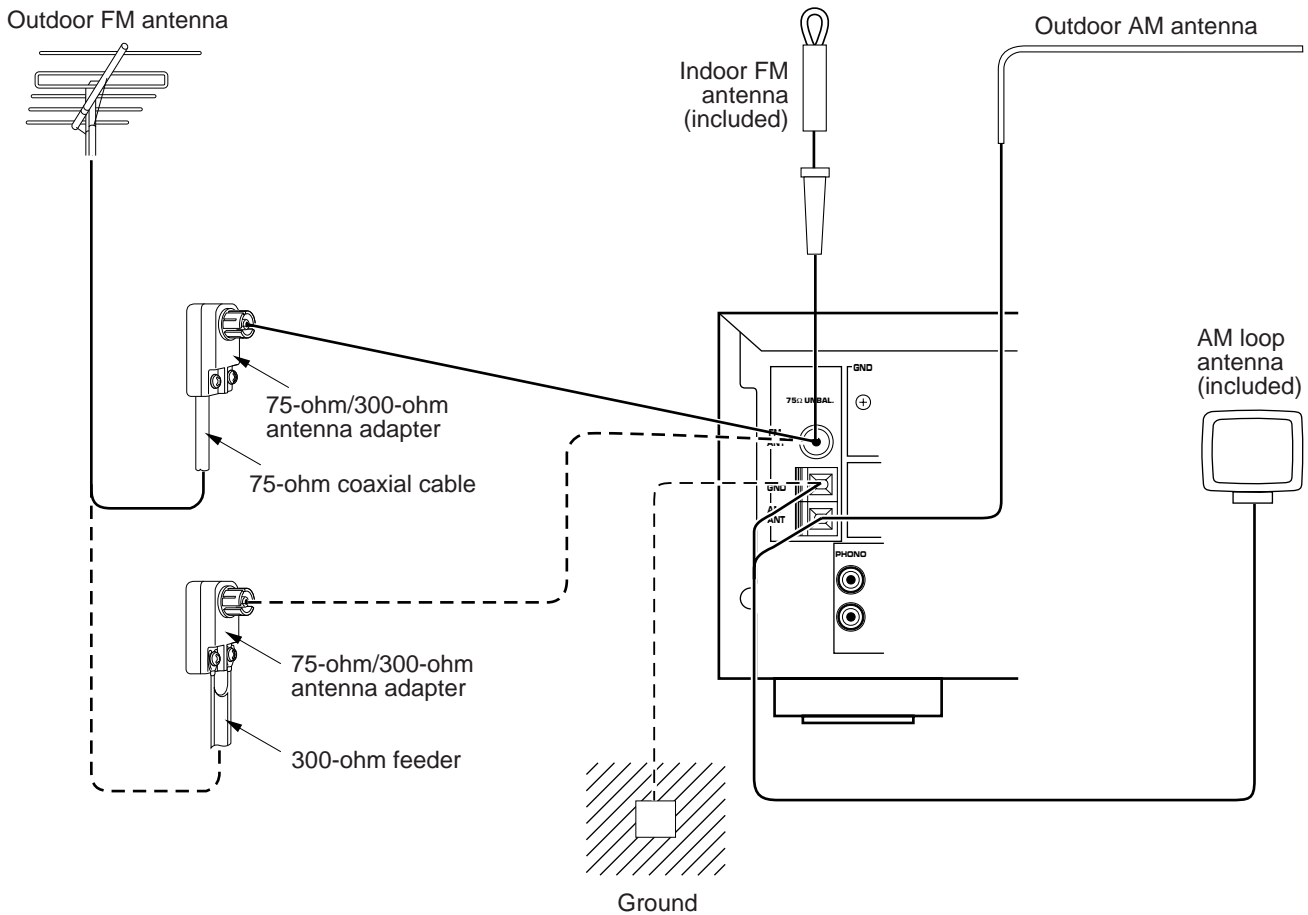

## Connecting the AM loop antenna

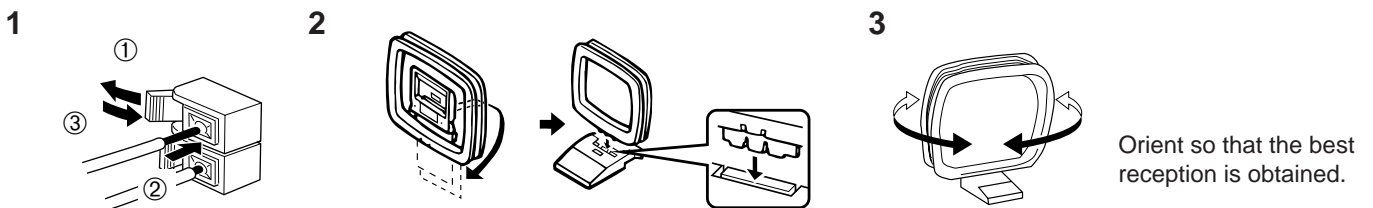

- \* The AM loop antenna should be placed apart from the main unit. The antenna may be hung on a wall.
- \* The AM loop antenna should be kept connected, even if an outdoor AM antenna is connected to this unit.

## GND terminal

For maximum safety and minimum interference, connect the **GND** terminal to a good earth ground. A good earth ground is a metal stake driven into moist earth.

## Notes

- When connecting the indoor FM antenna, insert its connector into the **FM ANT** terminal firmly.
- If you need an outdoor FM antenna to improve FM reception quality, either 300-ohm feeder or coaxial cable may be used. In locations troubled by electrical interference, coaxial cable is preferable.

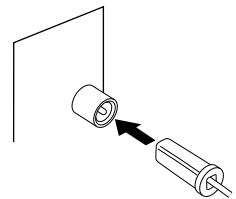

# CONTROLS AND THEIR FUNCTIONS

## FRONT PANEL

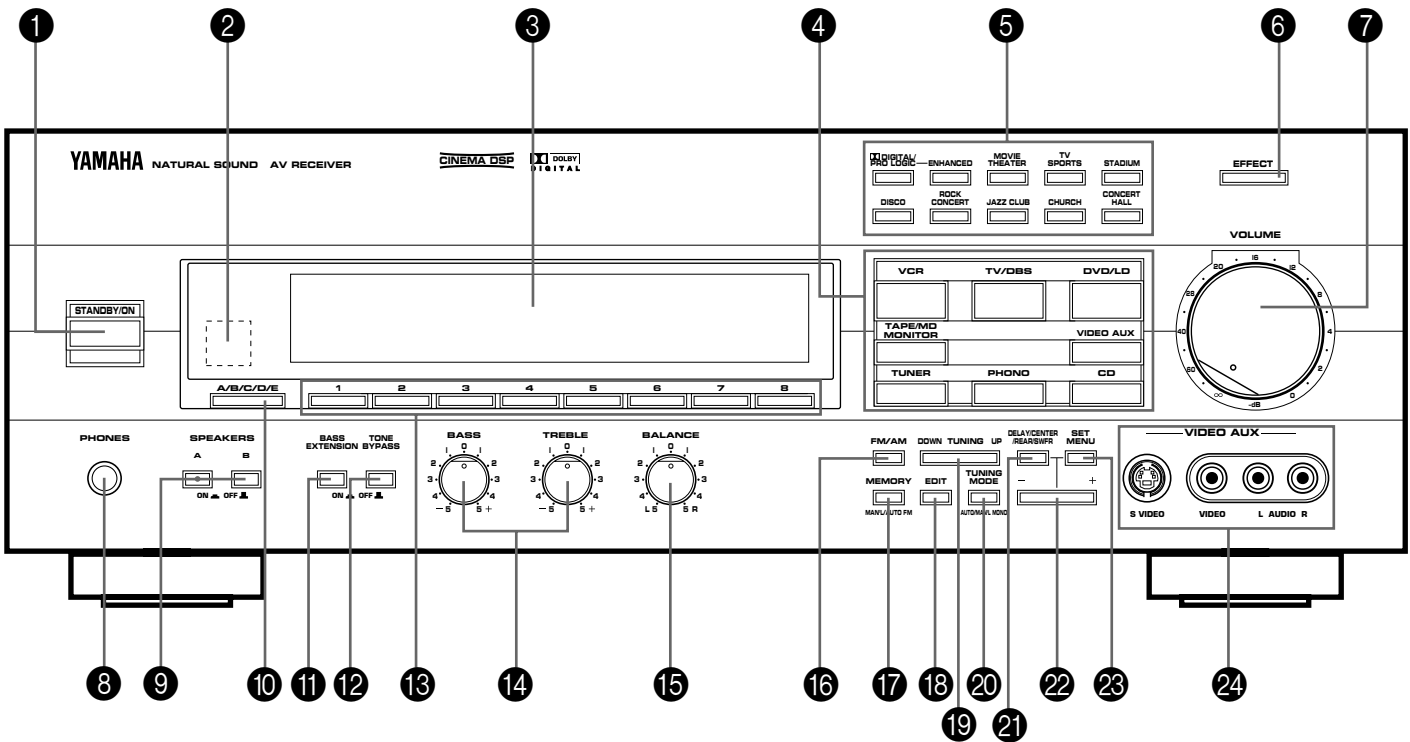

### 1 STANDBY/ON switch

Press this switch to turn the power to this unit on. Press it again to turn this unit into the standby mode.

\* When you press this switch to turn the power on, you will hear a click and a sound of the built-in fan rotating for a moment.

**Standby mode**  
In this state, this unit consumes a very small quantity of power to receive infrared-signals from the remote control transmitter.

### 2 Remote control sensor

Receives signals from the remote control transmitter.

### 3 Display panel

Shows various information. (For details, refer to page 21.)

### 4 Input selector buttons

Select a program source to listen to or watch. When a button is pressed, the name of selected source appears on the display.

### 5 DSP program selector buttons

Select a DSP program. When a button is pressed, the name of selected program lights up on the display.

### 6 EFFECT button

Switches on and off the output from the center and rear speakers so that the sound becomes normal 2-channels.  
\* Even if the output from the center and rear speakers is off, when the Dolby Digital (AC-3) is decoded, signals at all channels are distributed to the main channels and output from the main speakers.

### 7 VOLUME control

Used to raise or lower the volume level.

### 8 PHONES jack

When you listen with headphones, connect the headphones to the **PHONES** jack. You can listen to the sound to be output from the main speakers through headphones.

When listening with headphones privately, set both the **SPEAKERS A** and **B** switches to the **OFF** position and switch off the digital sound field processor (so that no DSP program name is illuminated on the display) by pressing the **EFFECT** button.

PHONES

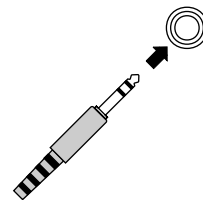

### 9 SPEAKERS switches

Set the switch **A** or **B** (or both **A** and **B**) for the main speaker system (connected to this unit) you will use to the **ON** position. Set the switch for the main speaker system you will not use to the **OFF** position.

### 10 A/B/C/D/E button

Press this button to select a desired group (A–E) of preset stations.

### 11 BASS EXTENSION switch

When this switch is pressed inward (ON), boosts bass frequency response at the main left and main right channels while maintaining overall tonal balance. If you do not have a subwoofer, the use of this switch will be effective to reinforce the bass frequencies.

### 12 TONE BYPASS switch

When this switch is pressed inward (ON), the input signal does not pass through the tone (**BASS** and **TREBLE**) control circuitry so that it is unaffected by the tone control circuitry. Use this switch to obtain pure sound and to check the tone control setting. Press this switch to release it outward (OFF) to use the tone control circuitry.

### 13 Preset station number selector buttons

Select a preset station number (1 to 8).

### 14 Tone controls

These controls are effective only for the sound from the main speakers.

#### **BASS**

Used to increase or decrease the low frequency response. The 0 position produces flat response.

#### **TREBLE**

Used to increase or decrease the high frequency response. The 0 position produces flat response.

### 15 BALANCE control

This control is effective only for the sound from the main speakers.

Adjusts the balance of the output volume to the left and right speakers to compensate for sound imbalance caused by speaker location or listening room conditions.

### 16 FM/AM button

Press this button to switch the reception band to FM or AM.

### 17 MEMORY (MAN'L/AUTO FM) button

When this button is pressed, the "MEMORY" indicator flashes for about 5 seconds. During this period, select a desired preset station number by pressing the corresponding preset station number selector button to enter the displayed station into the memory.

When this button is pressed and held for more than 3 seconds, the automatic preset tuning begins. (For details, refer to page 34.)

### 18 EDIT button

This button is used to exchange the places of two preset stations with each other.

### 19 TUNING DOWN/UP button

Used for tuning. Press the "UP" side to tune in to higher frequencies, and press the "DOWN" side to tune in to lower frequencies.

### 20 TUNING MODE (AUTO/MAN'L MONO) button

Press this button to switch the tuning mode to automatic or manual. To select the automatic tuning mode, press this button so that the "AUTO TUNING" indicator lights up on the display. To select the manual tuning mode, press this button so that the "AUTO TUNING" indicator goes off.

### 21 DELAY/CENTER/REAR/SWFR button

Whenever pressed, selects the item of changing delay time (DELAY), center speaker output level (CENTER), rear speaker output level (REAR) and subwoofer output level (SWFR) in turn.

\* Depending on a mode of this unit, the number of selections differs. For example, when the built-in digital sound field processor (including the Dolby Pro Logic Decoder or the Dolby Digital (AC-3) Decoder) is off, only the item for changing subwoofer output level can be selected.

### 22 +/- button

Adjusts the level of item selected by pressing the **DELAY/CENTER/REAR/SWFR** button. Moreover, performs setting changes and adjustments for functions selected by pressing the **SET MENU** button.

### 23 SET MENU button

Whenever pressed, selects functions in the SET MENU mode.

### 24 VIDEO AUX terminals

Connect an auxiliary video or audio input source unit such as a camcorder to these terminals. If the connected video unit has a S video output terminal, connect it to the S VIDEO terminal to obtain a high resolution picture. The source connected to these terminals can be selected by the corresponding input selector button.

## DISPLAY PANEL

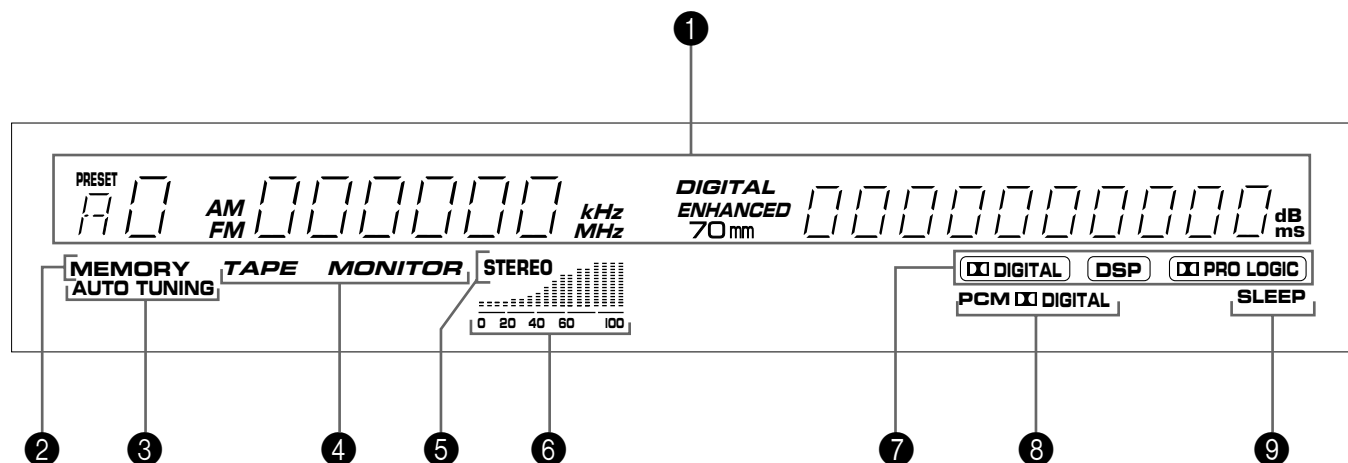

### 1 Multi-information display

Displays various information, for example station frequency, preset station number and name of selected input source.

### 2 MEMORY indicator

When the **MEMORY** button is pressed, this indicator flashes for about 5 seconds. During this period, the displayed station can be programmed to the memory by using the **A/B/C/D/E** button and the preset station number selector buttons.

### 3 AUTO TUNING indicator

Lights up when this unit is in the automatic tuning mode.

### 4 TAPE MONITOR indicator

Lights up when the tape deck (or MD recorder etc.) is selected as the input source by pressing the **TAPE/MD MONITOR** button.

### 5 STEREO indicator

Lights up when an FM stereo broadcast with sufficient signal strength is received.

### 6 Signal-level meter

Indicates the signal level of the received station. If multipath interference is detected, the indication decreases.

### 7 DIGITAL, DSP and PRO LOGIC indicators

" DIGITAL" lights up when the built-in Dolby Digital (AC-3) Decoder is on and the signals of selected source encoded with the Dolby Digital (AC-3) is not in 2-channels. "DSP" lights up when the built-in digital sound field processor is on, and " PRO LOGIC" lights up when the built-in Dolby Pro Logic Surround Decoder is on. Depending on the selected DSP program, both " DIGITAL" and "DSP", or both "DSP" and " PRO LOGIC" will light up.

### 8 Digital audio input signal indicators

When digital audio signals not encoded with the Dolby Digital (AC-3) are input to this unit, "PCM DIGITAL" lights up. When digital audio signals encoded with the Dolby Digital (AC-3) are input to this unit, " DIGITAL" lights up.

### 9 SLEEP indicator

Lights up while the built-in SLEEP timer is functioning.

# ADJUSTMENTS BEFORE USING THIS UNIT

## SELECTING THE OUTPUT MODES SUITABLE FOR YOUR SPEAKER SYSTEM

This unit provides you the following four functions to determine the method of distributing output signals to speakers suitable for your audio system. When speaker connections are all completed, select a proper position on each function to make the best use of your speaker system.

- 4. CENTER SPEAKER (CNTR)
- 5. REAR SPEAKER (REAR)
- 6. MAIN SPEAKER (MAIN)
- 7. LFE/BASS OUT (BASS)

### DESCRIPTION OF EACH FUNCTION

#### 4. CENTER SPEAKER

Choices: NRML/WIDE/PHNTM  
Preset position: NRML

##### NRML (Normal):

Select this position when you use a center speaker that is smaller than the main speakers. In this position, low bass signals (below 90 Hz) at the center channel are output from the main speakers (or the SUBWOOFER OUTPUT terminal if the SMALL position is selected on "6. MAIN SPEAKER" and the SWFR position is selected on "7. LFE/BASS OUT").

**WIDE:** Select this position when your center speaker is approximately the same size as the main speakers.

##### PHNTM (Phantom):

Select this position when you do not have a center speaker. The center channel sound will be output from the left and right main speakers.

#### 5. REAR SPEAKER

Choices: SMALL/LARGE  
Preset position: SMALL

**SMALL:** Select this position if your rear speakers do not have a high ability for bass reproduction.

In this position, low bass signals (below 90 Hz) at the rear channels are output from the SUBWOOFER OUTPUT terminal (or the main speakers if the MAIN position is selected on "7. LFE/BASS OUT").

**LARGE:** Select this position if your rear speakers have a high ability for bass reproduction, or a subwoofer is connected to the rear speaker in parallel. In this position, full range signals are output from the rear speakers.

#### 6. MAIN SPEAKER

Choices: SMALL/LARGE  
Preset position: LARGE

**SMALL:** Select this position if your main speakers do not have a high ability for bass reproduction. However, if your system does not include a subwoofer, do not select this position.

In this position, low bass signals (below 90 Hz) at the main channels are output from the SUBWOOFER OUTPUT terminal (if the SWFR or BOTH position is selected on "7. LFE/BASS OUT").

**LARGE:** Select this position if your main speakers have a high ability for bass reproduction.

In this position, full range signals present at the main channels are output from the main speakers.

#### 7. LFE/BASS OUT

Choices: MAIN/SWFR/BOTH  
Preset position: SWFR

**MAIN:** Select this position if your system does not include a subwoofer.

In this position, full range signals present at the main channels, signals from the LFE channel and other low bass signals that are selected on "4. CENTER SPEAKER" to "6. MAIN SPEAKER" to be distributed from other channels are output from the main speakers.

##### SWFR/BOTH:

Select either the SWFR or BOTH position if your system includes a subwoofer. In either position, signals at LFE channel and other low bass signals that are selected on "4. CENTER SPEAKER" to "6. MAIN SPEAKER" to be distributed from other channels are output from the SUBWOOFER OUTPUT terminal. When the LARGE position is selected on "6. MAIN SPEAKER", in the **SWFR** position, no signal is distributed from the main channels to the SUBWOOFER OUTPUT terminal, however in the **BOTH** position, low bass signals from the main channels are output to both of the main speakers and the SUBWOOFER OUTPUT terminal.



# METHOD OF CHANGING SELECTIONS

Operations should be made watching information on this unit's display panel or the monitor screen.

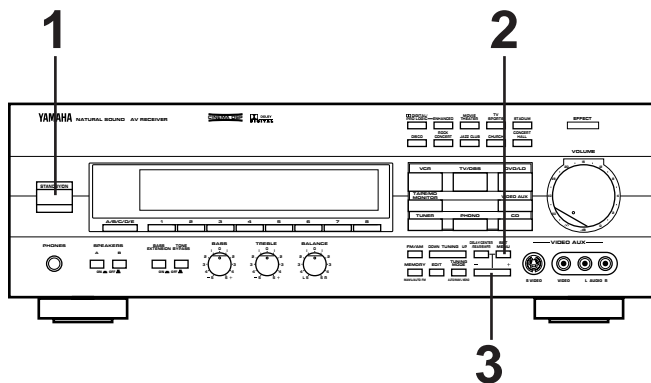

## TIME/LEVEL-SET MENU

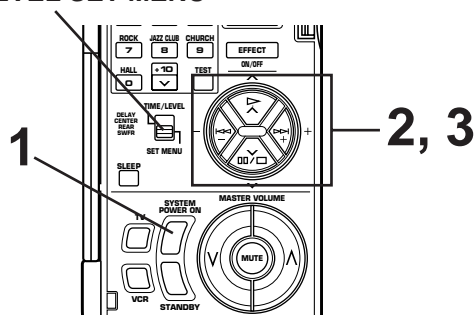

If you will use the remote control transmitter, set the **TIME/LEVEL-SET MENU** switch to the SET MENU position on the remote control transmitter.

**Note:** Be sure to use the remote control transmitter with the lid open.

**3** Press “+” or “-” once or more so that the arrow points the position you will select.

Front panel                      Remote control

or

↓

ENTR>WIDE

Changes.

**4** Repeat step 2 and 3 to change selections on “5. REAR SPEAKER” (REAR), “6. MAIN SPEAKER” (MAIN) and/or “7. LFE/BASS OUT” (BASS) in the same way.

**1** Turn the power to this unit on. (If you want to display information on the monitor, turn the power to the monitor on.)

Front panel                      Remote control

or

**2** Select the title “4. CENTER SPEAKER” by pressing once or more (so that “CNTR” appears on the display).

Front panel                      Remote control

or

↓

ENTR>NRML

# SPEAKER BALANCE ADJUSTMENT

This procedure lets you adjust the sound output level balance between the main, center, and rear speakers using the built-in test tone generator. When this adjustment is performed, the sound output level heard at the listening position will be the same from each speaker. This is important for the best performance of the digital sound field processor, the Dolby Digital (AC-3) decoder and the Dolby Pro Logic Surround decoder.

**The adjustment of each speaker output level should be done at your listening position with the remote control transmitter. Otherwise, the result may not be satisfactory.**

**Note:** Be sure to use the remote control transmitter with the lid open.

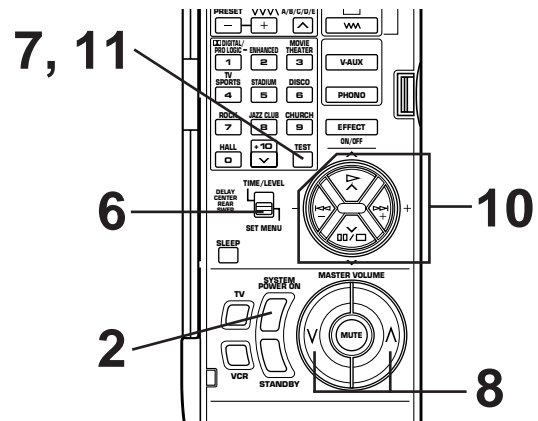
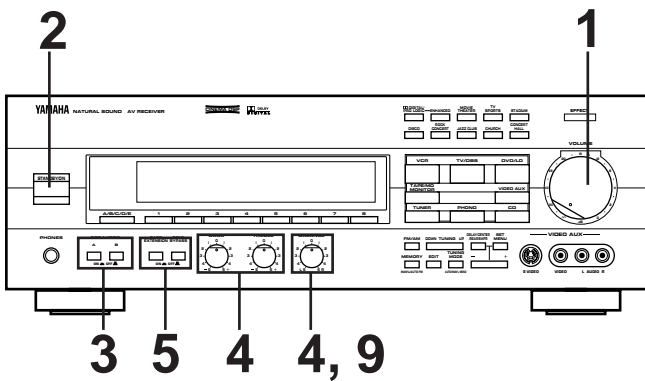

**1** Front panel

VOLUME

Set to the "∞" position.

**2** Turn the power on.

Front panel

Remote control

SYSTEM POWER ON

or

**3** Select the main speakers to be used.

Front panel

SPEAKERS

A B

**\*** If you use two main speaker systems, press both the A and B switches.

**4** Front panel

BASS TREBLE BALANCE

Set to the "0" position.

**5** Front panel

BASS TONE EXTENSION BYPASS

Set to the "OFF (⬇️)" position.

**6** Set the TIME/LEVEL-SET MENU switch on the remote control transmitter to the TIME/LEVEL position.

Remote control

TIME/LEVEL

SET MENU

**7** Remote control

TEST

➔ TEST LEFT

## 8 Turn up the volume.

Remote control

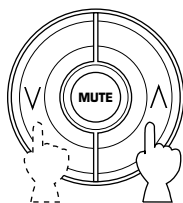

You will hear a test tone (like pink noise) from the left main speaker, then the center speaker, then the right main speaker, then the right rear speaker, and then the left rear speaker, for about two seconds each. The display changes as shown below.

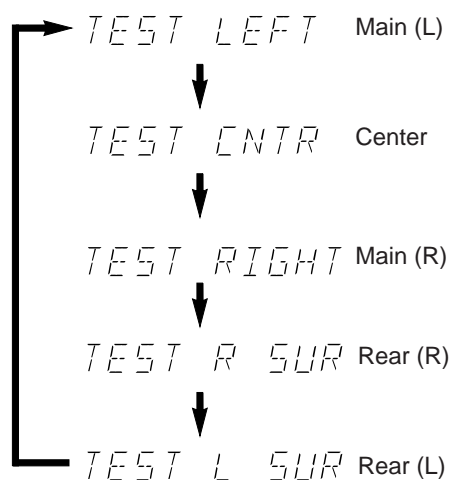

\* The state of test-tone output is also shown on the monitor screen by an image of audio listening room. This is convenient for adjusting each speaker level.

\* If the function "4. CENTER SPEAKER" in the SET MENU mode is set in the PHNTM (phantom) position, you will hear the center channel test tone from the left and right main speakers.

## 9 Adjust the **BALANCE** control so that the effect sound output level of the left main speaker and the right main speaker are the same.

Front panel



## 10 Adjust the sound output levels of the center speaker and the rear speakers so that they become almost as same as that of the main speakers.

- a) Press  $\wedge$  or  $\vee$  once or more so that "CENTER", "R SUR." or "L SUR." appears on the display.
- \* Select "CENTER" to adjust the output level of the center speaker, select "R SUR." to adjust the output level of the right rear speaker, and select "L SUR." to adjust the output level of the left rear speaker.

Remote control

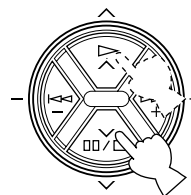

- b) Adjust its level.
- \* Pressing the + side raises and the - side lowers the level.
- \* While adjusting, the test tone is fixed on the selected speaker.

Remote control

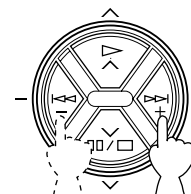

## 11 Cancel the test tone.

Remote control



→ TEST LEFT  
|  
Disappears.

### Notes

- Once you have completed these adjustments, you can adjust whole sound level on your audio system by using the **VOLUME** control (or the **MASTER VOLUME** keys on the remote control transmitter) only.
- If you use external power amplifiers, you may also use their volume controls to achieve proper balance.
- If the function "4. CENTER SPEAKER" in the SET MENU mode is set in the "PHNTM (phantom)" position, in step 10, the sound output level of the center speaker cannot be adjusted. This is because in this mode, the center sound is automatically output from the left and right main speakers.
- If there is insufficient sound output from the center and rear speakers, you may decrease the main speaker output level by setting the **MAIN LEVEL** switch on the rear panel to "-10 dB".

# ADJUSTMENTS IN THE "SET MENU" MODE

The following eight types of functions maximize the performance of your system and expand your enjoyment for audio listening and video watching.

- |                            |                         |
|----------------------------|-------------------------|
| 1. CENTER DELAY (C. DELAY) | 5. REAR SPEAKER (REAR)  |
| 2. DYNAMIC RANGE (D. RNG)  | 6. MAIN SPEAKER (MAIN)  |
| 3. LFE LEVEL (LFE)         | 7. LFE/BASS OUT (BASS)  |
| 4. CENTER SPEAKER (CNTR)   | 8. TV/DBS INPUT (INPUT) |

## METHOD OF SETTING CHANGE AND ADJUSTMENT

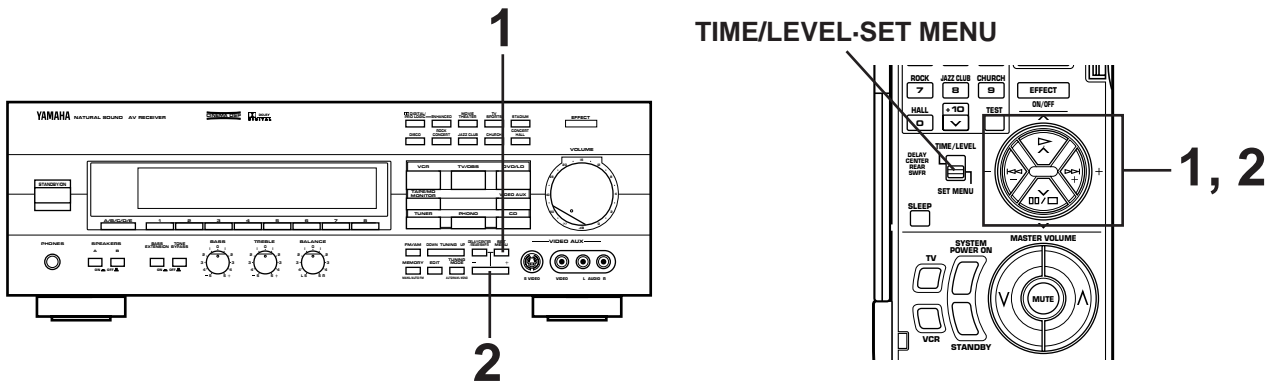

Operations should be made watching information on this unit's display panel or the monitor screen. If you want to display information on the monitor, turn the power to the monitor on.

If you will use the remote control transmitter, set the **TIME/LEVEL-SET MENU** switch to the SET MENU position on the remote control transmitter.

**Note:** Be sure to use the remote control transmitter with the lid open.



**2** Select any desired position or edit parameters on the function.

Front panel

Remote control

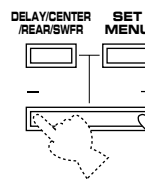

or

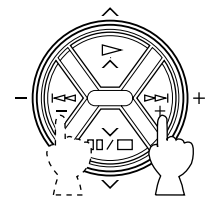

**1** Press once or more until the title of function on which you will make a change appears on the display.

Front panel

Remote control

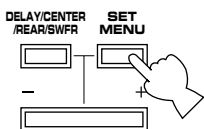

or

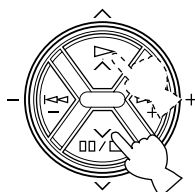

**3** Repeat step 1 and 2 to make a setting change or adjustment on any other function.

## DESCRIPTIONS OF THE FUNCTIONS

### 1. CENTER DELAY (Adjusting the delay of center sounds (dialog etc.))

**Control range: 0 ms to 5 ms (in 1 ms step)**  
**Preset value: 0 ms**

- \* This adjustment is effective only when the Dolby Digital (AC-3) is decoded and the signals of selected source encoded with the Dolby Digital (AC-3) contain center-channel signals.

Adjusts the delay between the main sounds (at the main channels) and dialog etc. (at the center channel). The larger the value, the later the dialog etc. is generated.

This is for making sounds from the left main, center and right main speakers reach your listening position at the same time by delaying the sound from the center speaker if the distance from the center speaker to your listening position is shorter than the distance from the left or right main speaker to your listening position.

### 2. DYNAMIC RANGE (Adjusting dynamic range)

**Choices: MAX/STD/MIN**  
**Preset position: MAX**

- \* This adjustment is effective only when the Dolby Digital (AC-3) is decoded.

**MAX:** "Dynamic range" is the difference between the maximum level and the minimum level of sounds. Sounds on a movie originally designed for movie theaters feature very wide dynamic range. Dolby Digital (AC-3) technology can bring the original sound track into a home audio format with this wide dynamic range unchanged. In this position, a source encoded with the Dolby Digital (AC-3) is reproduced in the original sound track's wide dynamic range providing you with powerful sounds like a movie theater. Selecting this position will be more ideal if you can listen to a source in a high output level in a room specially soundproofed for audio/video enjoyment.

**STD (Standard):**

Powerful sounds of extremely wide dynamic range are not always suitable for home use. Depending upon the condition of your listening environment, it may not be possible to increase the sound output level as high as a movie theater. However, in a level suitable for listening to in your room, the low level parts of source sound cannot be heard well because they will be lost among noises in your environment.

Dolby Digital (AC-3) technology also made it possible to reduce an original sound track's dynamic range for a home audio format by "compressing" the data of sound.

In this position, a source encoded with the Dolby Digital (AC-3) is reproduced in the "compressed" dynamic range of the source suitable for low level listening.

- MIN:** In this position, dynamic range is more reduced than in the STD position. Selecting this position will be effective when you must listen to a source in extremely low level.

### 3. LFE LEVEL (Adjusting the output level at the LFE (low frequency effect) channel)

**Control range: -14 dB to 0 dB (in 2 dB step)**  
**Preset value: 0 dB**

- \* This adjustment is effective only when the Dolby Digital (AC-3) is decoded and the signals of selected source encoded with the Dolby Digital (AC-3) contain LFE signals.

Adjusts the output level at the LFE (low frequency effect) channel. If the LFE signals are mixed with signals at other channels to output them from the same speakers, the ratio of LFE signal level to the level of other signals are adjusted. (See page 6 for details about the LFE channel.)

### 4. CENTER SPEAKER 5. REAR SPEAKER 6. MAIN SPEAKER 7. LFE/BASS OUT

See pages 22 to 23 for details. (Once you have selected proper modes, you do not have to make a setting change until any alteration is made in your speaker system.)

### 8. TV/DBS INPUT (Selecting the initial input mode of the sources connected to the TV/DBS input terminals)

For the sources connected to the TV/DBS input terminals of this unit only, you can designate the input mode that is automatically selected when the power of this unit is switched on.

- AUTO:** In this position, the AUTO input mode is always selected when the power of this unit is switched on.  
**LAST:** In this position, the input mode you have selected last time is memorized and will not be changed even if the power of this unit is switched on.

- \* See page 29 for details about switching the input mode.



**6** Play the source. (For detailed information on the tuning operation, refer to page 32.)

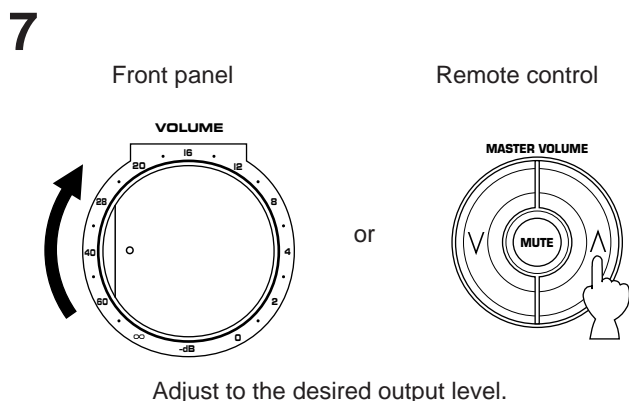

**8** If desired, adjust the **BASS, TREBLE, BALANCE** controls, etc. (refer to page 31) and use the digital sound field processor. (Refer to page 36.)

## Switching the input mode (for DVD/LD and TV/DBS)

This unit allows you to switch the input mode only for sources connected to the DVD/LD and TV/DBS input terminals (on the rear of this unit) that input two or three types of signals to this unit.

The following two input modes are provided.

### AUTO: For the source connected to the DVD/LD input terminals:

This mode is automatically selected when you turn on the power to this unit. In this mode, input signal is automatically selected by the following order of priority.

1. Digital input signal from the OPTICAL terminal
2. Digital input signal from the COAXIAL terminal
3. Analog input signal

### For the source connected to the TV/DBS input terminals:

This mode is automatically selected when you turn on the power to this unit if the "AUTO" position is selected on "8. TV/DBS INPUT" in the SET MENU mode. (For details, refer to page 27.) In this mode, input signal is automatically selected by the following order of priority.

1. Digital input signal from the COAXIAL terminal
2. Analog input signal

### ANALOG:

In this mode, only analog input signal is selected even though digital signal is input at the same time. Select this mode when you want to use the analog input signal instead of the digital input signal.

### Notes on input mode selection

- To play back a source with the Dolby Digital (AC-3) decoded, set the input mode to "AUTO".
- For the TV/DBS source only, the input mode selected on the function "8. TV/DBS INPUT" in the SET MENU mode is selected when you turn on the power of this unit.
- When you want to enjoy a source which has normal 2-channel signals with a Dolby Pro Logic Surround program, select the ANALOG mode.
- In the AUTO mode, there may be a case depending on some LD players or DVD players that when you make a search on a source encoded with the Dolby Digital (AC-3) during the play and then the play is restored, sound output is interrupted for a moment because the digital input signal is selected again.

## When you finish using this unit

Press the **STANDBY/ON** switch on the front panel again or the **STANDBY** key on the remote control transmitter to turn this unit into the standby mode.

### Notes on using the input selector buttons

- Note that pressing on each input selector button selects the source which is connected to the corresponding input terminals on the rear panel.
  - \* To select the source connected to the **VIDEO AUX** terminals on the front panel, press **VIDEO AUX**.
- The selection of **TAPE/MD MONITOR** cannot be canceled by pressing another input selector button. To cancel it, press **TAPE/MD MONITOR** again so that the "TAPE MONITOR" indicator disappears from the display. When you select a button other than **TAPE/MD MONITOR**, make sure that the "TAPE MONITOR" indicator is not illuminated on the display.
- If you select the input selector button for a video source without canceling the selection of **TAPE/MD MONITOR**, the playback result will be the video image from the video source and the sound from the audio tape (or MD etc.).
- Once you play a video source, its video image will not be interrupted even if the input selector button for an audio source is selected.
- When you select an input source by pressing the corresponding input selector button, the DSP program (or the state of no DSP program is used) which was used when the same input source was selected the last time will automatically recalled.

## TO RECORD A SOURCE TO TAPE (OR MD)

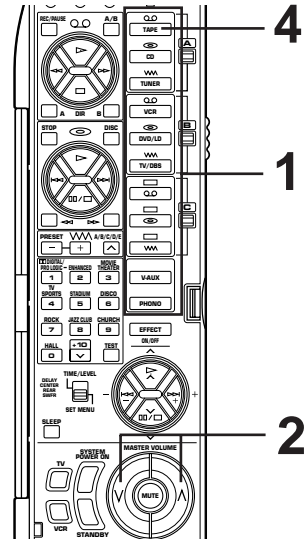
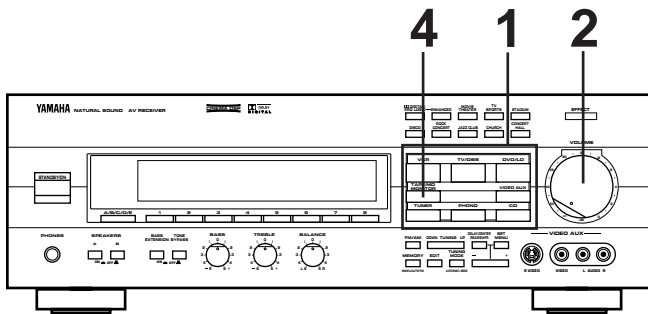

**Note:** If you will use the remote control transmitter, be sure to use it with the lid open.

**1** Select the source to be recorded.

Front panel Remote control

or

**2** Play the source and then turn the **VOLUME** control up to confirm the input source. (For detailed information on the tuning operations, refer to the page 32.)

Front panel Remote control

or

**3** Begin recording on the tape deck (or MD recorder etc.) or VCR connected to this unit.

**4** If the tape deck (or MD recorder etc.) is used for recording, you can monitor the sounds being recorded by pressing **TAPE/MD MONITOR** so that the "TAPE MONITOR" indicator lights up on the display.

Front panel Remote control

or

### Notes

- The settings of DSP and the **VOLUME, BASS, TREBLE, BALANCE** controls and the **BASS EXTENSION** switch have no effect on the material being recorded.
- Composite video and S video signals pass independently through this unit's video circuits. Therefore, when recording or dubbing video signals, if your video source unit is connected to provide only a S video (or only a composite video) signal, you can record only a S video (or only a composite video) signal on your VCR.
- A source that is connected to this unit between digital terminals only cannot be recorded by a tape deck or VCR connected to this unit.
- Please check the copyright laws in your country to record from records, compact discs, radio, etc. Recording of copyright material may infringe copyright laws.

If you watch a video software that uses scramble or encoded signals to prevent it from being dubbed, there may be a case that display information superimposed on the picture and/or the picture itself is disturbed due to those signals.



## Selecting the SPEAKER system

Because one or two speaker systems (as main speakers) can be connected to this unit, the **SPEAKERS** switches allow you to select speaker system **A** or **B**, or both at once.

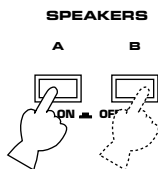

## Adjusting the BALANCE control

Adjust the balance of the output volume to the left and right speakers to compensate for sound imbalance caused by speaker location or listening room conditions.



### Note

This control is effective only for the sound from the main speakers.

## Adjusting the BASS and TREBLE controls

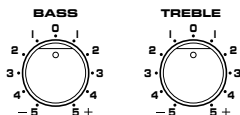

**BASS** : Turn this clockwise to increase (or counter-clockwise to decrease) the low frequency response.

**TREBLE** : Turn this clockwise to increase (or counter-clockwise to decrease) the high frequency response.

### Note

These controls are effective only for the sound from the main speakers.

## Using the BASS EXTENSION switch

You can boost bass frequency response by setting this switch to the "ON" position. This switch is effective only on the sound from the main speakers.

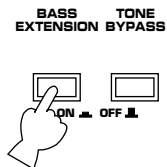

## Using the TONE BYPASS switch

Press this switch inward (ON) if you want to listen to pure source sound. The input signal does not pass through the tone (**BASS** and **TREBLE**) control circuitry so that it is unaffected by the tone control circuitry. Press this switch to release it outward (OFF) to use the tone control circuitry.

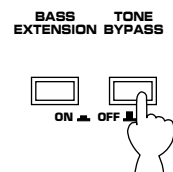

# TUNING OPERATIONS

Normally, if station signals are strong and there is no interference, quick automatic-search tuning (AUTOMATIC TUNING) is possible. However, if signals of the station you want to select are weak, you must tune to it manually (MANUAL TUNING).

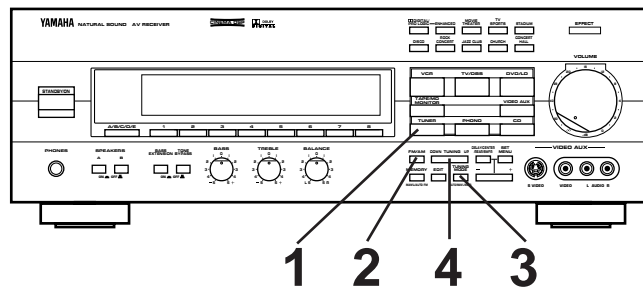

## AUTOMATIC TUNING

**1** Select "TUNER" as the input source.

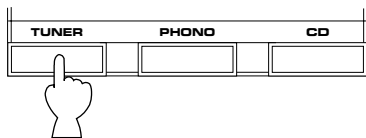

**2** Select the reception band (FM or AM) confirming it on the display.



**3** Turn the "AUTO TUNING" indicator off.

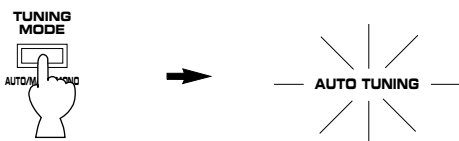

**4** To tune to a higher frequency, press the right side once.  
To tune to a lower frequency, press the left side once.

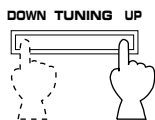

- \* If the station where tuning search stops is not the desired one, press again.
- \* If the tuning search does not stop at the desired station (because the signals of the station are weak), change to the MANUAL TUNING method.

## MANUAL TUNING

**1** Select "TUNER" as the input source.

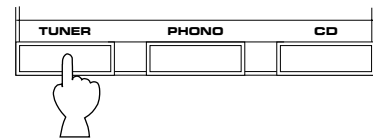

**2** Select the reception band (FM or AM) confirming it on the display.



**3** Turn the "AUTO TUNING" indicator off.

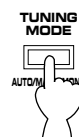

**4** Tune to a desired station manually.

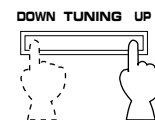

- \* To continue tuning search, press and hold the button.

### Note

If you tune to an FM station manually, it is received in monaural mode automatically to increase the signal quality.

# PRESET TUNING

## MANUAL PRESET TUNING

This unit can store station frequencies selected by tuning operation. With this function, you can recall any desired station by only selecting the preset station number where it is stored. Up to 40 stations (8 stations x 5 groups) can be stored.

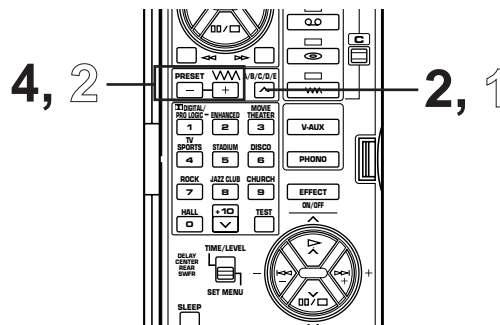
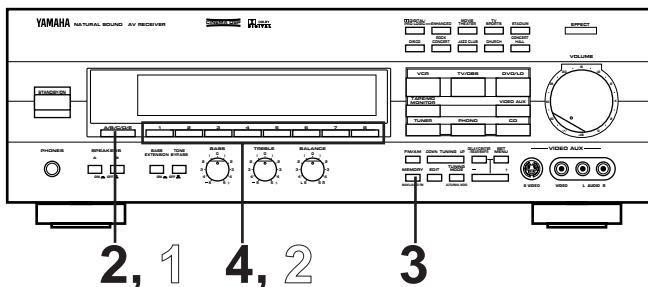

### To store stations

- 1** Tune to a desired station.  
(Refer to the previous page for tuning procedure.)
- 2** Select a desired group (A – E) of preset stations confirming it on the display.

Front panel      Remote control
- 3** Front panel

Flashes on and off for about 5 seconds.
- 4** Select a preset station number where you want to program the station before the "MEMORY" indicator goes off from the display.

Front panel      Remote control

Shows the displayed station has been programmed to A1.

\* In the same way, program other stations to A2, A3 ... A8.  
\* You can program more stations to preset station numbers on other groups in the same way by selecting other groups in step 2.

### To recall a preset station

- 1** Select the group of preset stations.

Front panel      Remote control
- 2** Select the preset station number.

Front panel      Remote control

#### Notes

- A new setting can be programmed in place of the former one.
- For presets, the setting of the reception mode (stereo or monaural) is stored along with the station frequency.

#### Memory back-up



The memory back-up circuit prevents the programmed data from being lost even if this unit is turned into the standby mode or the power plug is disconnected from the AC outlet or the power is cut due to temporary power failure. If, however, the power is cut for more than one week, the memory may be erased. If so, it can be re-programmed by simply following the PRESET TUNING steps.

## AUTOMATIC PRESET TUNING

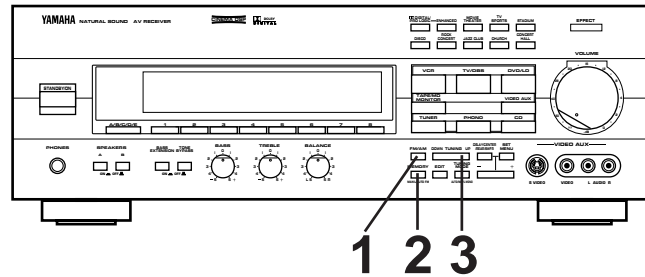
You can also make use of an automatic preset tuning function for FM stations only. By this function, this unit performs automatic tuning and stores FM stations with strong signals sequentially. Up to 40 stations are stored automatically in the same way as in the manual preset tuning method on page 33.

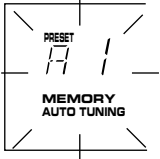
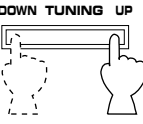

### To store stations

<b>1</b>	 <span style="margin-left: 20px;">→</span> 
<b>2</b>	 <span style="margin-left: 20px;">→</span>  <p style="text-align: center;">Flashes.</p> <p>Press and hold for more than 3 seconds.</p>
<b>3</b>	 <p>To tune to higher frequencies, press right side once. To tune to lower frequencies, press left side once. * If the <b>TUNING</b> button is not pressed, in a while, the automatic preset tuning begins automatically toward higher frequencies.</p> <p>The automatic preset tuning begins from the frequency currently displayed. Received stations are programmed to A1, A2 ... A8 sequentially. * If more than 8 stations are received, they are also programmed to the preset station numbers on other groups (B, C, D and E) in that order.</p>

### When the automatic preset tuning is finished

The display shows the frequency of the last preset station. Check the contents and the number of preset stations by following the procedure of the section "To recall a preset station" on page 33.

### To recall a preset station

Simply follow the procedure of the section "To recall a preset station" on page 33.

### Notes

- You can replace a preset station by another FM or AM station manually by simply following the procedure of the section "To store stations" on page 33.
- If the number of received stations is not enough to be stored up to E8, the search is finished automatically after searching all frequencies.
- With this function, only FM stations with sufficient signal strength are stored automatically. If the station you want to program is weak in signal strength, tune to it in monaural manually and program it by following the procedure of the section "To store stations" on page 33.

### If you want to store the first station received by the automatic preset tuning to a desired preset station number.

If, for example, you want to store the first received station to C5, select "C5" by using the **A/B/C/D/E** button and the preset station number selector buttons after pressing the **MEMORY** button in step 2. Then press the **TUNING** button. The first received station is stored to C5, and next stations to C6, C7 ... sequentially.

If stations are stored up to E8, the automatic preset tuning is finished automatically.



# USING DIGITAL SOUND FIELD PROCESSOR (DSP)

This unit incorporates a sophisticated, multi-program digital sound field processor. The processor allows you to electronically expand and change the shape of the audio sound field from both audio and video sources, creating a theater-like experience in your listening room. You can create an excellent audio sound field by selecting a suitable sound field program (this will, of course, depend on what you will be listening to), and adding desired adjustments.

In addition, this unit incorporates a Dolby Digital (AC-3) decoder and a Dolby Pro Logic Surround decoder for multi-channel sound reproduction of sources encoded with Dolby Surround. The operation of these decoders can be controlled by selecting a corresponding DSP program including a combined operation of the YAMAHA DSP and the Dolby Digital (AC-3) or the Dolby Pro Logic Surround.

For details about digital sound field programs, see page 40 to 41.

## PLAYING A SOURCE WITH AN EFFECT OF THE DIGITAL SOUND FIELD PROCESSOR (DSP)

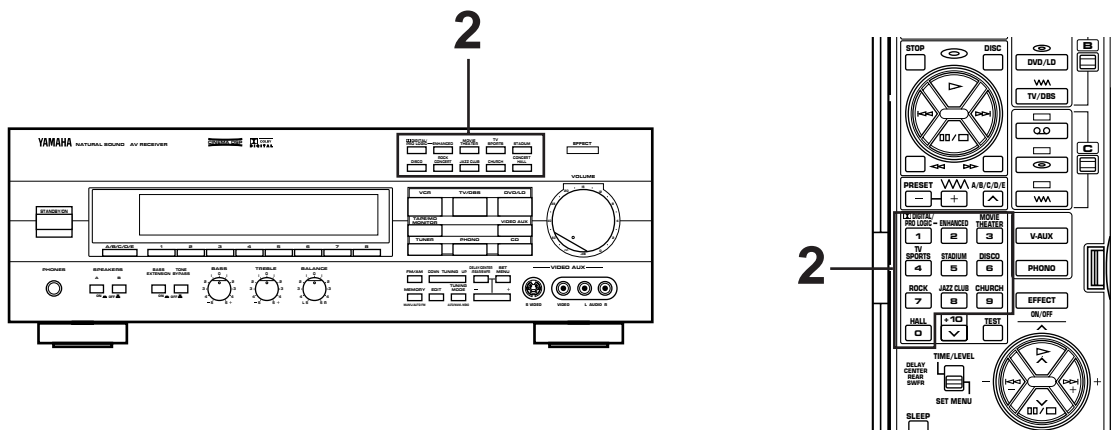

**1** Follow steps 1 – 7 shown in “**BASIC OPERATIONS**” on pages 28 to 29.

**2** Select the desired program that is suitable for the source.

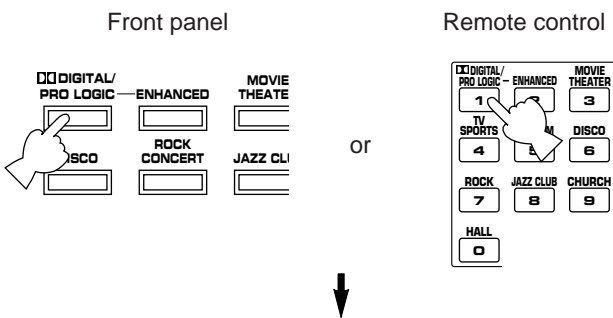

\* The name of selected program lights up on the display panel and the monitor screen.

**3** If desired, adjust the delay time and the output level of each speaker. (For details, refer to the corresponding descriptions on page 38 and 39.)

### Notes

- Program selection can be made to individual input sources. Once you select a program, it is linked with the input source selected at that time. So, when you select the input source next time, the same program is automatically called.
- If you prefer to cancel the DSP, press the **EFFECT** button. The sound will be the normal 2-channel stereo without surround sound effect.
- When a monaural sound source is played with **DOLBY PRO LOGIC** or **DOLBY PRO LOGIC ENHANCED**, no sound is heard from the main speakers and the rear speakers. Sound is heard only from the center speaker. However, if the center channel mode is in **PHANTOM**, the main speakers output the sound of the center channel.
- When this unit's Dolby Pro Logic Surround decoder or Dolby Digital decoder is used, if the main-source sound is considerably altered by overadjustment of the **BASS** or **TREBLE** control, the relationship between the center and rear channels may produce an unnatural effect.

## To enjoy a video source with the Dolby Pro Logic Surround or Dolby Digital (AC-3) decoded

When you select the program No. 1, 2 or 3, and the input signal of the source is 2-channel stereo, Dolby Pro Logic Surround is decoded. When some program is selected and the input signal of the source is encoded with the Dolby Digital (AC-3), Dolby Digital (AC-3) is automatically decoded.

\* The following indicators on the display panel show you what sound processing is being made.

Lights up when the Dolby Digital (AC-3) is being decoded and the signals of selected source encoded with the Dolby Digital (AC-3) is not in 2-channels.

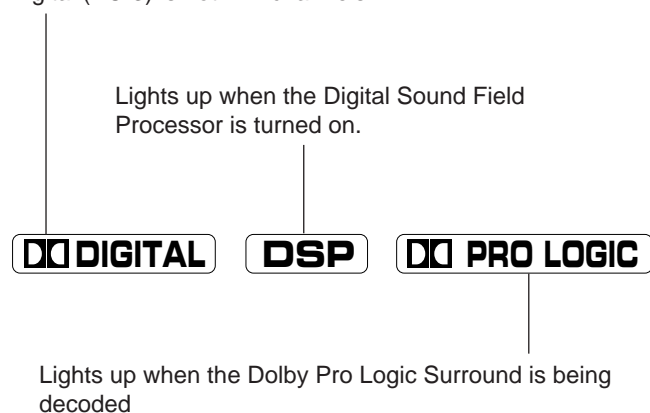

\* In addition, for the program No. 1, 2 and 3, the name of the program on the display panel or the monitor screen will change according to the type of decoding. (For details, refer to page 40.)

### Note

If the input signals of source encoded with the Dolby Digital (AC-3) are in 2-channels only, the sound processing for them is similar to that for analog or PCM audio signals.

## To cancel the effect sound

The **EFFECT** button on the front panel and the **EFFECT ON/OFF** key on the remote control transmitter make it simple to compare the normal stereo sound with the fully processed effect sound.

To cancel the effect sound and monitor only the main sound, press the **EFFECT ON/OFF** key or the **EFFECT** button. Press the **EFFECT ON/OFF** key or the **EFFECT** button a second time to restore normal operation.

Front panel

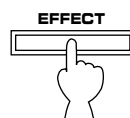

or

Remote control



### Notes

- If the effect sound is canceled when signals encoded with the Dolby Digital (AC-3) are input to this unit, signals of all channels are mixed and are output from the main speakers.
- If the **EFFECT** button or the **EFFECT ON/OFF** key is pressed to turn effect sounds OFF when the Dolby Digital (AC-3) is decoded, it may happen that sound is output faintly or not output normally depending on a source. In that case, press the **EFFECT** button or the **EFFECT ON/OFF** key to turn effect sounds ON, or use input signals not encoded with the Dolby Digital (AC-3).

# ADJUSTING DELAY TIME AND EACH SPEAKER OUTPUT LEVEL

In using the digital sound field processor including the Dolby Pro Logic Decoder or the Dolby Digital (AC-3) Decoder, you can adjust delay time between the main sound and effect sound, and each speaker output level as you prefer.

**Note:** These adjustments can be made only when the effect sound is on. If none of the indicators **DSP**, **DIGITAL** and **PRO LOGIC** are not illuminated on the display panel, press the **EFFECT** switch on the front panel or the **EFFECT ON/OFF** key on the remote control transmitter so that at least one of those indicators lights up on the display panel.

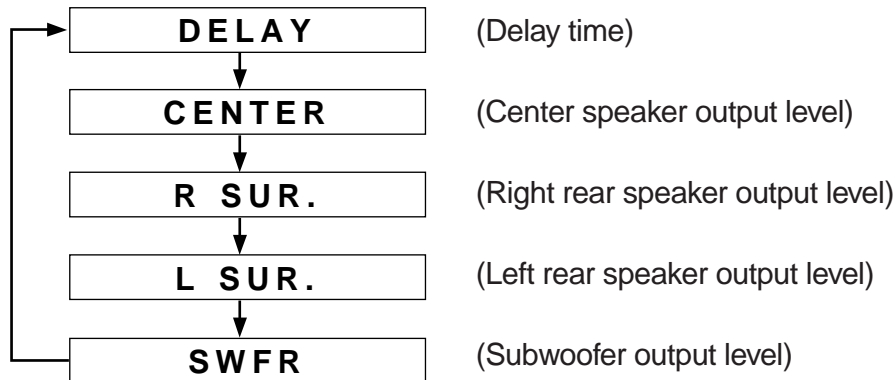

## Method of adjustment

If you will use the remote control transmitter, set the **TIME/LEVEL-SET MENU** switch to the **TIME/LEVEL** position on the remote control transmitter.

**Note:** Be sure to use the remote control transmitter with the lid open.



**2** Adjust the level on the selected item.

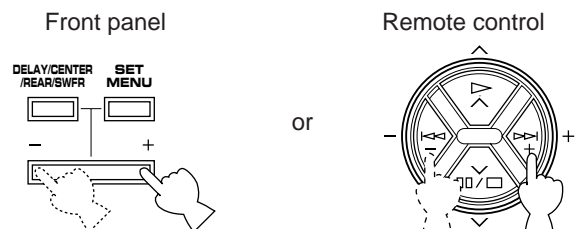

**1** Press once or more until the name of item on which you will make an adjustment appears on the display panel.

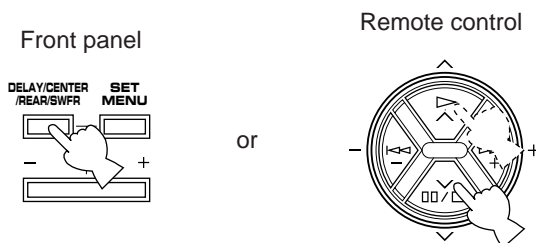

Whenever pressed, the selection changes as the above chart shows.

- \* Pressing the  $\wedge$  key on the remote control transmitter changes the selection in the reverse order.
- \* Depending on a mode of this unit, you cannot select all items.

**3** Repeat step 1 and 2 to make adjustments on other items.



## Adjusting delay time

You can adjust the time difference between the beginning of the sound from the main speakers and the beginning of the effect sound from the rear or front effect speakers.

The larger the value, the later the effect sound is generated. This adjustment can be made to all programs individually.

### Notes

- Adding too much delay will cause an unnatural effect with some sources.
- When the  $-/+$  button is pressed, sound is momentarily interrupted.

Program	Control range (ms)	Preset value
1. DOLBY PRO LOGIC	15 to 30	20
DOLBY DIGITAL	0 to 15	15
2. PRO LOGIC ENHANCED	15 to 30	20
DOLBY DIGITAL ENHANCED	0 to 15	15
3. 70 mm MOVIE THEATER	15 to 30	17
DIGITAL MOVIE THEATER	1 to 50	22
4. TV SPORTS	1 to 50	20
5. STADIUM	1 to 50	45
6. DISCO	1 to 50	14
7. ROCK CONCERT	1 to 50	22
8. JAZZ CLUB	1 to 50	26
9. CHURCH	1 to 50	40
10. CONCERT HALL	1 to 50	30

## Adjusting output level of the center, right rear and left rear speakers, and subwoofer

If desired, you can adjust the sound output level of the each speaker even if the output level is already set in "SPEAKER BALANCE ADJUSTMENT" on pages 24 to 25.

### Notes

- Output level of the center speaker cannot be adjusted when the program STADIUM, DISCO, ROCK CONCERT, JAZZ CLUB, CHURCH or CONCERT HALL is selected, and the input signal is analog, PCM audio or encoded with the Dolby Digital (AC-3) in 2-channels.

- If the function "4. CENTER SPEAKER" in the SET MENU mode is set in the "PHNTM (phantom)" position, the sound output level of the center speaker cannot be adjusted. This is because in this mode, the center sound is automatically output from the left and right main speakers.
- Once the output level is adjusted, the level value will be the same in all the digital sound field programs.

Speakers	Control range (dB)	Preset value
CENTER	MIN, -20 to +10	0
RIGHT SURROUND	MIN, -20 to +10	0
LEFT SURROUND	MIN, -20 to +10	0
SUBWOOFER	MIN, -20 to 0	0









### Note

The values of the delay time, center level, rear level and subwoofer output level you set the last time will remain memorized even when this unit is in the standby mode. However, if the power cord is kept disconnected for more than one week, these values will be automatically changed back to the original factory settings.

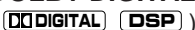
# BRIEF OVERVIEW OF DIGITAL SOUND FIELD PROGRAMS

The following list gives you a brief description of the sound fields produced by each of the DSP programs. Keep in mind that most of these are precise digital recreations of actual acoustic environments. The data for these sound fields was recorded at actual locations using sophisticated sound field measurement equipment.

**Note**  
The channel level balance between the left and right rear effect speakers may vary depending on the sound field you are listening to. This is due to the fact that most of these sound field recreations are actual acoustic environments.

No.	PROGRAM	FEATURE
1	<p><b>DOLBY PRO LOGIC</b> (  ) Functions when the input signal is analog or PCM audio. Speaker output: main, center, rear</p> <p><b>DOLBY DIGITAL</b> (  ) Functions when the input signal is Dolby Digital. Speaker output: main, center, rear</p>	<p>Reproduces video discs, video tapes and similar sources which are Dolby Surround encoded and bear the "DOLBY SURROUND" logo.</p> <p>The built-in Dolby Pro Logic Surround decoder or Dolby Digital (AC-3) decoder precisely reproduces sounds and sound effects of a source encoded with Dolby Surround. The realization of a highly efficient decoding process improves crosstalk and channel separation and makes sound positioning smoother and more precise.</p>
2	<p><b>DOLBY PRO LOGIC ENHANCED</b> (   ) Functions when the input signal is analog or PCM audio. Speaker output: main, center, rear</p> <p><b>DOLBY DIGITAL ENHANCED</b> (   ) Functions when the input signal is Dolby Digital. Speaker output: main, center, rear</p>	<p>Reproduces video discs, video tapes and similar sources which are Dolby Surround encoded and bear the "DOLBY SURROUND" logo.</p> <p>This program ideally simulates the multi-surround speaker systems of the 35 mm film theater. The Dolby Surround decoding and the digital sound field processing is precisely performed without altering the originally designed sound orientation. The surround effects produced by this sound field folds the viewer naturally from the rear to the left and right and toward the screen.</p> <p><b>Note:</b> If the main channel sound is considerably altered by overadjustment of the <b>BASS</b> or <b>TREBLE</b> controls, the relationship with the rear channels may produce an unnatural effect.</p>
3	<p><b>70 mm MOVIE THEATER</b> (   ) Functions when the input signal is analog or PCM audio. Speaker output: main, center, rear</p> <p><b>DIGITAL MOVIE THEATER</b> (   ) Functions when the input signal is Dolby Digital. Speaker output: main, center, rear</p>	<p>Ideal for reproducing video discs, video tapes and similar sources which are Dolby Surround encoded and bear the "DOLBY SURROUND" logo.</p> <p>This program is ideal for precisely reproducing the sound design of the newest 70 mm/Dolby Digital multi-track films. The sound field is made to be similar to that of the newest movie theaters, so the reverberations of the sound field itself are restrained as much as possible. The three dimensional feeling of the sound field is emphasized, and dialog is precisely oriented on the screen. You can enjoy watching Sci-Fi, adventure movies, etc. with much presence.</p>

No.	PROGRAM	FEATURE
4	<b>TV SPORTS</b> When the input signal is analog or PCM audio: ( <b>DSP</b> ) Speaker output: main, center, rear When the input signal is Dolby Digital: ( <b>DIGITAL</b> <b>DSP</b> ) Speaker output: main, center, rear	This program is furnished with a tight sound field in which the sound will not spread excessively on the front side, but the rear surround side produces a dynamic sound expansion. This program is the most suitable for sports programs.
5	<b>STADIUM</b> When the input signal is analog or PCM audio: ( <b>DSP</b> ) Speaker output: main, rear When the input signal is Dolby Digital: ( <b>DIGITAL</b> <b>DSP</b> ) Speaker output: main, center, rear	This program gives you long delays between direct sounds and effect sounds, and extraordinarily spacious feel of a large stadium.
6	<b>DISCO</b> When the input signal is analog or PCM audio: ( <b>DSP</b> ) Speaker output: main, rear When the input signal is Dolby Digital: ( <b>DIGITAL</b> <b>DSP</b> ) Speaker output: main, center, rear	This program recreates the acoustic environment of a lively disco in the heart of a very lively city. The sound is dense and highly concentrated. It is also characterized by a high-energy, "immediate" sound.
7	<b>ROCK CONCERT</b> When the input signal is analog or PCM audio: ( <b>DSP</b> ) Speaker output: main, rear When the input signal is Dolby Digital: ( <b>DIGITAL</b> <b>DSP</b> ) Speaker output: main, center, rear	This program is ideally suited for rock music. You will experience a very dynamic or lively sound field.
8	<b>JAZZ CLUB</b> When the input signal is analog or PCM audio: ( <b>DSP</b> ) Speaker output: main, rear When the input signal is Dolby Digital: ( <b>DIGITAL</b> <b>DSP</b> ) Speaker output: main, center, rear	This is a small, cozy jazz club with a low ceiling. The sound is very close and intimate.
9	<b>CHURCH</b> When the input signal is analog or PCM audio: ( <b>DSP</b> ) Speaker output: main, rear When the input signal is Dolby Digital: ( <b>DIGITAL</b> <b>DSP</b> ) Speaker output: main, center, rear	This program recreates the acoustic environment of a big church with a high pointed dome and columns along the sides. This interior produces very long reverberations.
10	<b>CONCERT HALL</b> When the input signal is analog or PCM audio: ( <b>DSP</b> ) Speaker output: main, rear When the input signal is Dolby Digital: ( <b>DIGITAL</b> <b>DSP</b> ) Speaker output: main, center, rear	In this program, the center will appear to be deep behind the main speakers, creating an expansive large hall ambience. Orchestra and opera music are suited for this sound field.

**Note:** The "PHNTM" position is selected on "4. CENTER SPEAKER" in the SET MENU mode, no sound is output from the center speaker(s).

# SETTING THE SLEEP TIMER

If you use the SLEEP timer of this unit, you can make this unit turn into the standby mode. When you are going to sleep while enjoying a broadcast or other desired input source, this timer function is helpful.

## Notes

- The SLEEP timer can be controlled only with the remote control transmitter.
- The components on which the SLEEP timer is effective are the sources connected to the **SWITCHED AC OUTLET(S)** on the rear panel of this unit.

## To set the SLEEP time

**1**

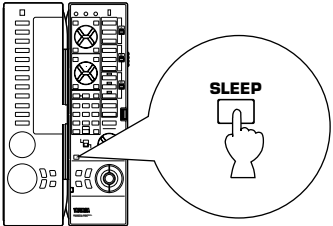

Press once or more to select the desired SLEEP time.

↓

Indicates the SLEEP time.

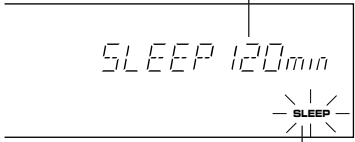

Flashes.

Whenever the **SLEEP** key is pressed, the SLEEP time will change as follows.

(Minutes)

120 → 90 → 60 → 30

The SLEEP timer is off (**OFF**).  
(The state before the **SLEEP** key is pressed.)

After a while, the display returns to the indication before the SLEEP timer is set.

**2** The unit will be turned into the standby mode automatically at the selected SLEEP time.

## To cancel the selected SLEEP time

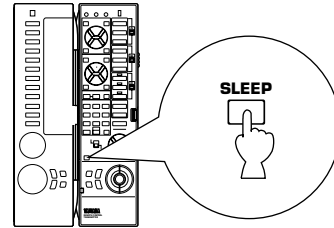

Press once or more so that "SLEEP OFF" appears on the display. (It will soon disappear and the "SLEEP" indicator will go off from the display.)

## Note

The SLEEP timer setting can also be canceled by turning this unit into the standby mode with the **STANDBY/ON** switch on the front panel (or the **STANDBY** key on the remote control transmitter) or disconnecting the power plug of this unit from the AC outlet.

# REMOTE CONTROL TRANSMITTER

## BASIC OPERATIONS (When the lid is open)

The remote control transmitter provided with this unit is designed to control all the most commonly used functions of this unit. If the CD player, tape deck, LD player, DVD player, etc. connected to this unit are YAMAHA components designed for remote control compatibility, then this remote control transmitter will also control various functions of each component.

\* For basic operations, use the remote control transmitter with the lid open.

## NAMES OF KEYS AND THEIR FUNCTIONS

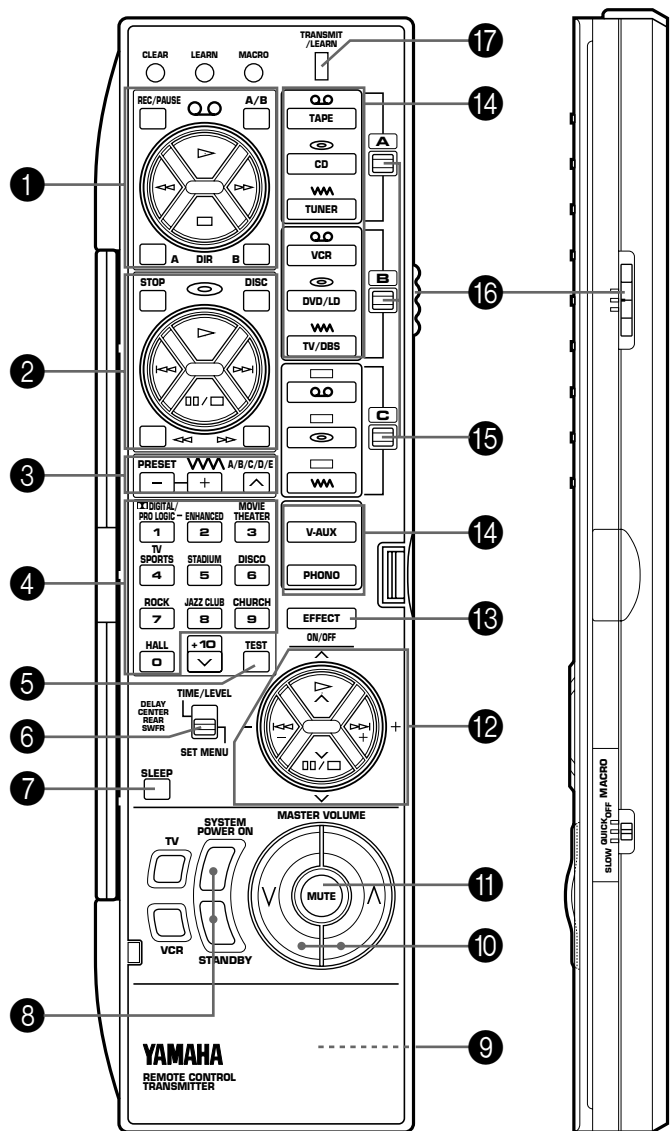

Lid is opened.

Side panel

### 1 Tape deck keys

Controls tape deck.

(The A/B/C switch (16) should be set to the "A" position.)

- \* **DIR A, B** and **A/B** are applicable only to double cassette tape deck.
- \* For a single cassette deck with automatic reverse function, pressing **DIR A** will reverse the direction of tape running.

### 2 CD/LD/DVD player keys

Controls compact disc player, LD player or DVD player.

(To control compact disc player, set the A/B/C switch (16) to the "A" position. To control LD player or DVD player, set the A/B/C switch (16) to the "C" position.)

- \* **DISC** is applicable only to compact disc changer.
- \* **STOP** is applicable only to LD player or DVD player.

### 3 Tuner keys

Controls tuner.

(The A/B/C switch (16) should be set to the "A" position.)

- +**: Selects higher preset station number.
- : Selects lower preset station number.
- A/B/C/D/E**: Selects the group (A – E) of preset station numbers.

### 4 DSP program selector keys

Selects a DSP program when the built-in digital sound field processor (including the Dolby Pro Logic Surround decoder and the Dolby Digital (AC-3) decoder) is on.

### 5 TEST key

Used for speaker balance adjustment. (For details, refer to page 24–25.)

### 6 TIME/LEVEL-SET MENU switch

Set to the TIME/LEVEL position when you will make an adjustment on delay time, center speaker output level, rear speaker output level or subwoofer level. Set to the SET MENU position when you will make an adjustment or setting change on a function in the SET MENU mode.

### 7 SLEEP timer key

This key is used to turn the built-in SLEEP timer on and off, and to set the SLEEP time. (For details, refer to page 42.)

### 8 SYSTEM POWER ON and STANDBY keys

Pressing the **SYSTEM POWER ON** key turns the power to this unit on and pressing the **STANDBY** key turns this unit into the standby mode.

### 9 RESET button

This button is inside the battery compartment.

Press this button to "reset" the internal microcomputer which controls remote control operations. Microcomputer "reset" is necessary when the remote control freezes.

- \* Pressing the **RESET** button will not erase learned functions.

### 10 MASTER VOLUME ^ (up) and v (down) keys

Turns the volume level up and down.

### 11 MUTE key

When pressed, this key mutes the volume level. To resume the original volume level, press this key again.

While muting, the indicator on the **VOLUME** control flashes continuously.

### 12 ^ / v and -/+ keys

^ (up) and v (down) keys change items (or functions) in the mode selected by the **TIME/LEVEL-SET MENU** switch. – and + keys make an adjustment or setting change on the item (or function) selected by the ^ or v key.

### 13 EFFECT ON/OFF key

Switches on/off the digital sound field processor (including the Dolby Pro Logic Surround decoder and the Dolby Digital (AC-3) decoder).

### 14 Input selector keys

Selects input source.

### 15 A/B/C indicators

The position (A, B or C) selected by the A/B/C switch is shown in red.

### 16 A/B/C switch

This switch must be used only when the lid of the remote control transmitter is open. (This switch will not function when the lid is closed.)

Normally, set this switch to the "A" position. When controlling a Yamaha LD player or DVD player by using the CD/LD/DVD player keys (2), set this switch to the "C" position.

### 17 TRANSMIT/LEARN indicator

Lights up when the remote control transmitter is transmitting infrared signals (when a command key is pressed).

#### Note

When using the keys to control Yamaha components, identify them with your component's keys. If these keys are identical, their functions will be the same. For each key function, refer to the corresponding instruction in your component's manual.

RESET button

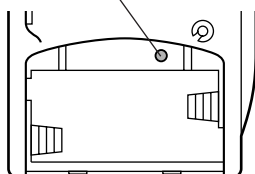

## LEARNING NEW CONTROL FUNCTIONS (When the lid is open)

This is a learning remote control transmitter. The shaded keys in the illustration shown below can be programmed to “learn” control functions from other remote control transmitters. By learning key-functions from other remote control transmitter, this unit can then be used in place of one or more other remote control transmitters, thus making operation of your various audio and video components more convenient.

Some of the “learning-capable” keys are originally empty and others have already been preset with functions to control this unit and other Yamaha components. You can store new functions to them (in place of preset functions) as desired.

\* See page 50 for the learning method.

\* See page 52 for clearing a learned function (or all learned functions).

### Note

If the memory capacity of the remote control transmitter becomes full, no further learning is possible even if some learning-capable keys are not occupied with new functions. If, for example, you store Yamaha codes only into this remote control transmitter, up to about 20 functions can be stored. Store new functions to the learnable-capable keys which are useful for you.

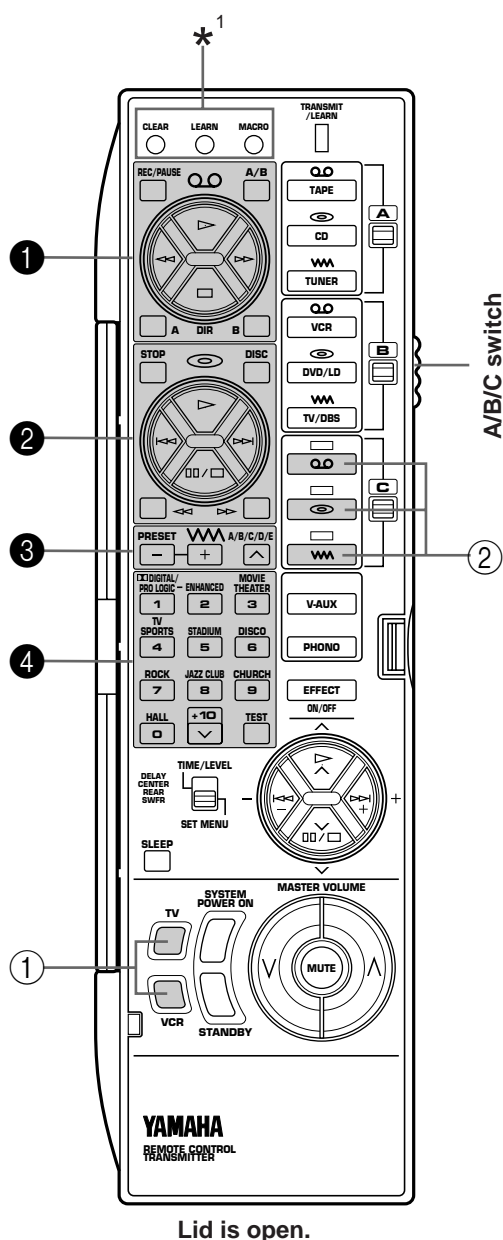

Lid is open.

### Keys which can have three functions (①, ②, ③, ④)

In the “Learning-capable” keys, the keys numbered ①–④ in the illustration at left can have three functions. This is because they have three memory areas (A, B and C). (One function per area.) You can store new functions into the area B and C, and use three functions on a key by switching the memory areas with the **A/B/C switch**. (Area A cannot learn a new function.)

#### To use these keys:

1. Before using a key, select the area A, B or C of the key on which the function you want to use is stored by using the **A/B/C switch**.
2. Press the key.

The original factory settings of these keys are as follows.

	The position of A/B/C switch		
	A	B	C
①	Preset with functions for controlling a Yamaha tape deck.	Empty	Empty
②	Preset with functions for controlling a Yamaha CD player. ( <b>STOP</b> is empty.)	Empty	Preset with functions for controlling a Yamaha LD player and DVD player. ( <b>DISC</b> is empty.)
③	Preset with functions for controlling the built-in tuner.	Empty	Empty
④	Preset as the DSP program selector keys (1–9, 0) and the <b>TEST</b> key. (+10 is empty.)	Preset as the DSP program selector keys (1–9, 0) and the <b>TEST</b> key. (+10 is empty.)	Preset as the DSP program selector keys (1–9, 0) and the <b>TEST</b> key. (+10 is empty.)

#### Note

The area A of all keys cannot learn new functions. To store new functions to these keys, store them onto the area B or C.

### Empty keys (①, ②)

These are empty keys. Each key can learn a function from another remote control transmitter.

For example, the **TV** key is useful for storing the function of your TV's power switch, and the **VCR** key can be used for your VCR's power switch.

\*<sup>1</sup>: These buttons are used for learning a new function or clearing a learned function (or all learned functions). For details, refer to page 50 to 52.

**Note**

If a key which has a preset function learns a new function, the preset function will not be deleted, but disabled. When the learned function is cleared, the preset function is restored. (For information on clearing a learned function, refer to page 52.)

**About the marks shown on the remote control transmitter**

The marks on the remote control transmitter signify functions of keys, input sources, etc.

**Examples)**

- ◻◻ (tape): Tape deck, VCR, etc.
- ◻◻ (disc): CD player, LD player, etc.
- ◻◻ (radio wave): Tuner, TV/BS tuner, etc.

These marks are helpful for storing new functions.

**Examples)**

- The area B of keys ① is suitable for storing functions to control your VCR.
- The area B of keys ③ is suitable for storing functions to control your TV/BS tuner.

**USING OPERATION CONTROL KEYS (When the lid is closed)**

When the lid of the remote control transmitter is closed, you can easily operate Yamaha components including learned functions by using the **OPERATION CONTROL** keys.

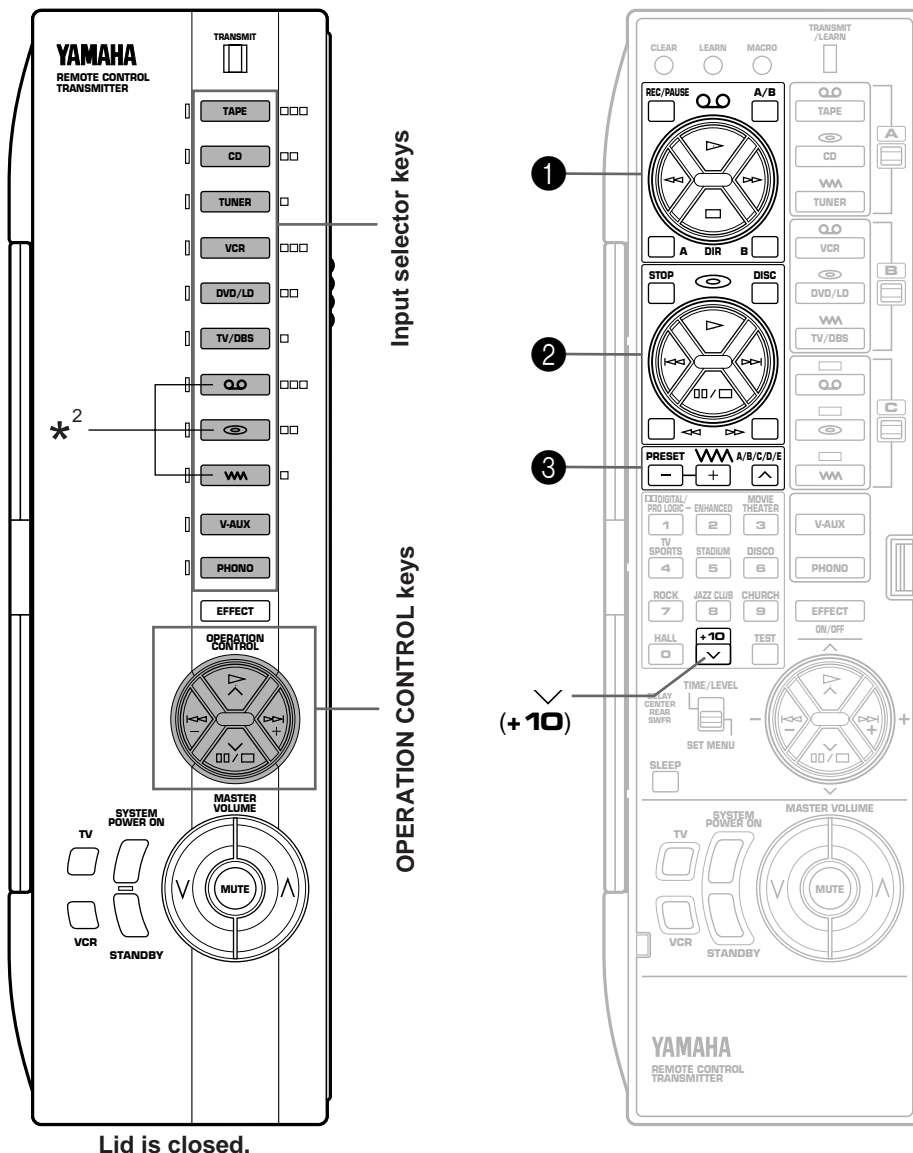

Lid is closed.

\*<sup>2</sup>: These keys are originally empty. If these keys have learned functions, pressing them executes those learned functions.



When the lid is closed, the **OPERATION CONTROL** keys substitute for the keys numbered ①, ②, ③ and the √ (+10) key on the left illustration. To use these keys, you do not have to switch the A/B/C switch. The functions which the **OPERATION CONTROL** keys carry out are determined by which input selector key was pressed before using the **OPERATION CONTROL** keys.

#### Note

When the lid is closed, the **EFFECT, MASTER VOLUME, MUTE, TV** and **VCR** keys will function in the same way as when the lid is open.

\* If the **MACRO** switch on the side of the remote control transmitter is set to "OFF", when the lid is closed, the **SYSTEM POWER ON** and **STANDBY** keys also will function in the same way as when the lid is open.

#### Examples of operations controlled by using the OPERATION CONTROL keys

##### To operate a Yamaha CD player

1. Press the "CD" input selector key.
2. Use the **OPERATION CONTROL** keys. (They carry out the functions in area A of keys ②.)

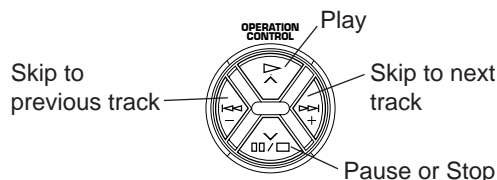

##### To operate your VCR

1. Press the "VCR" input selector key.
2. Use the **OPERATION CONTROL** keys. (They carry out the functions in area B of keys ①. This area is originally preset with no function. You must store the functions related to controlling the VCR in area B of keys ① beforehand.)

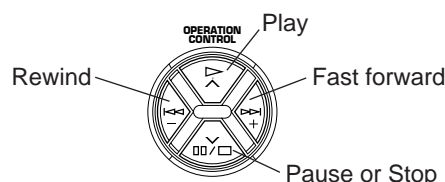

See the table below for a combination of an input selector key and key functions which the **OPERATION CONTROL** keys carry out. (Also, refer to the table on page 45.)

Selected input selector	Key functions which the OPERATION CONTROL keys carry out
TAPE	Functions in area A of keys ① (except REC/PAUSE, A/B, DIR A and B)
CD	Functions in area A of keys ② (except STOP, DISC, <<< and >>> )
TUNER	Functions in area A of keys ③ and √ (+10)
VCR	Functions in area B of keys ① (except REC/PAUSE, A/B, DIR A and B)
DVD/LD	Functions in area B of keys ② (except STOP, DISC, <<< and >>> )
TV/DBS	Functions in area B of keys ③ and √ (+10)
QD	Functions in area C of keys ① (except REC/PAUSE, A/B, DIR A and B)
⊖	Functions in area C of keys ② (except STOP, DISC, <<< and >>> )
WA	Functions in area C of keys ③ and √ (+10)

Pressing the "V-AUX" or "PHONO" input selector key has no effect on the **OPERATION CONTROL** keys.

#### Notes

- If the **OPERATION CONTROL** keys substitute for keys which has no function (empty), no command is carried out. According to your plan, store functions from other remote control transmitters into an empty area of those keys. (Refer to page 50 for the learning method.)
- While playing an audio/video unit, if you want to operate another unit by using the remote control transmitter (for example, if you want to rewind a tape on your VCR while listening to a CD), you should open the lid of the remote control transmitter and use the A/B/C switch and the corresponding keys. (If you press an input selector key with the lid closed to change the functions of the **OPERATION CONTROL** keys to the functions for controlling a VCR, the input of currently playing CD source is canceled.)

## MACRO OPERATIONS (When the lid is closed)

“Macro” is a command which defines a sequence of several operations.

The keys shown in the illustrations below (as **preset macro keys**) are also preset with macros, in addition to individual functions.

Each macro key is preset so that simply pressing it alone will carry out several functions of other keys on this remote control transmitter sequentially. (To know what key functions are sequentially carried out by pressing each preset macro key, see the next page.)

Macros can be used only when the lid is closed and the **MACRO** switch is set to “SLOW” or “QUICK”. (If “OFF” is selected, no macro will function even if the lid is closed.)

Preset macro keys are originally preset with macros. If you prefer, however, you can change the contents of a macro key by storing a desired series of functions on it. You can store up to seven functions onto a macro key. (Refer to page 51 for the learning method.)

### Setting the MACRO switch

**OFF:** In this position, no macro will function even if the lid of remote control transmitter is closed.





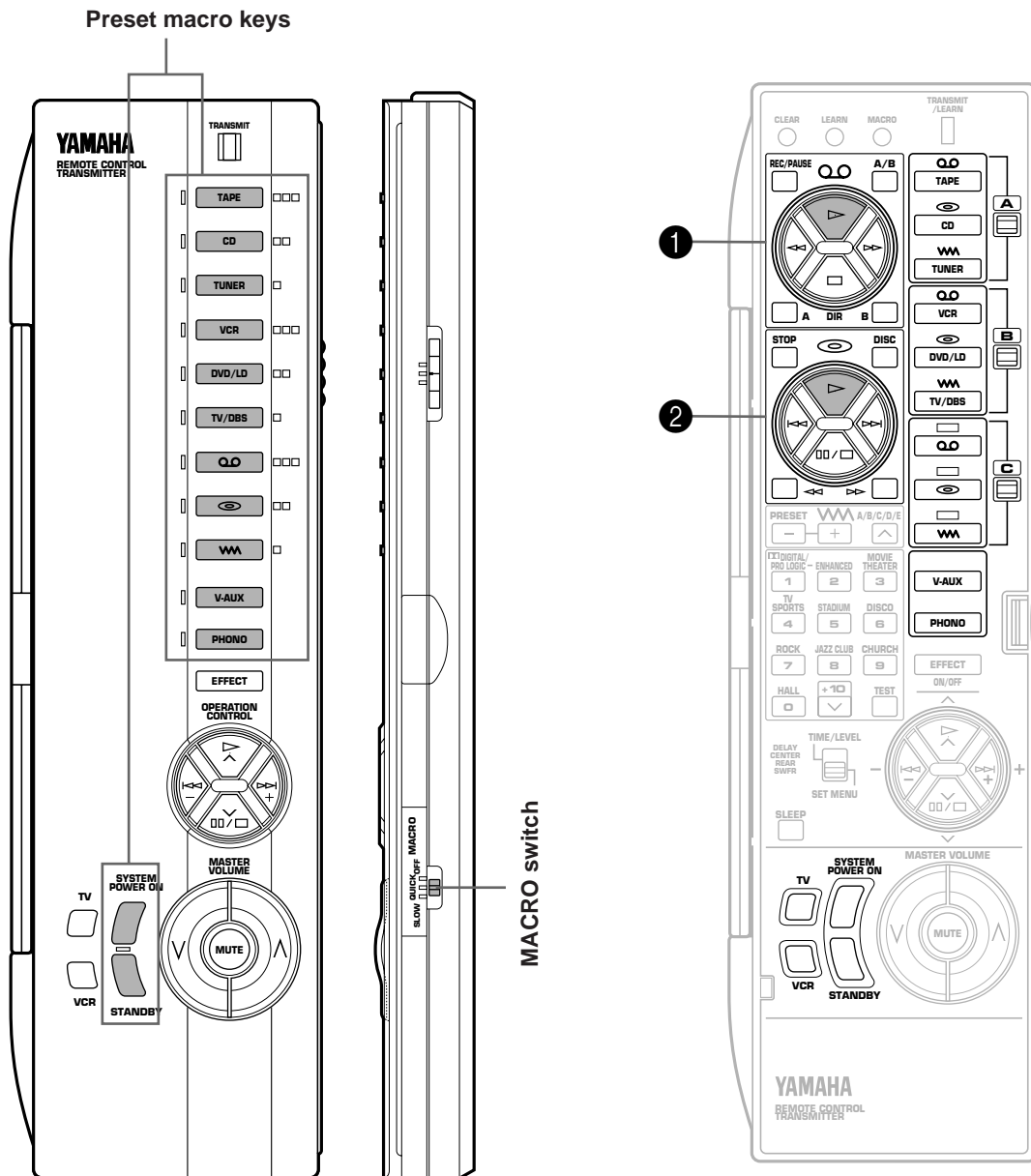





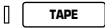

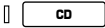





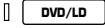

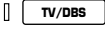

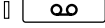

**QUICK:** In this position, when a macro key is pressed, each command is transmitted at 0.5 second intervals.





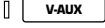

**SLOW:** In this position, when a macro key is pressed, each command is transmitted at 3 second intervals.



Lid is closed.  
(Set the MACRO switch to “QUICK” or “SLOW”.)

Preset macro keys and the key functions which they carry out sequentially are as follows. (Also, refer to the table on page 45.)

Macro key	Function of the key (and area) which operates when a macro key is pressed		
	1st (Turning the power of this unit on)	2nd (Selecting an input source)	3rd (Playing a source)
 TAPE		 TAPE	“▷” on area A of keys ①
 CD		 CD	“▷” on area A of keys ②
 TUNER		 TUNER	—
 VCR		 VCR	“▷” on area B of keys ①
 DVD/LD		 DVD/LD	“▷” on area B of keys ②
 TV/DBS		 TV/DBS	—
 Q.D		 Q.D	“▷” on area C of keys ①
 		 	“▷” on area C of keys ②
 WMA		 WMA	—
 V-AUX		 V-AUX	—
 PHONO		 PHONO	—

Macro key	Function of the key which operates when a macro key is pressed		
	1st	2nd	3rd
			
		—	—

### Notes

- A key in which no function is stored will carry out no command.
- If it occurs that this unit will not receive the second command because the internal operation of the first command takes a long time, set the **MACRO** switch to the “SLOW” position, or add no function or repeat the same command between the first command and the next command.
- If you will program the power on/off switching function of TV, VCR, etc. as part of a macro sequence, note that it switches the current mode to the other (“on” to “off”, or “off” to “on”). For example, when you press the macro key, if the power of TV, VCR, etc. is already on, the power will be turned off even though you may not want it to do so.
- Once you press a macro key, this unit will not receive the command of another key (even if it is pressed) until this unit finishes carrying out all commands of the macro key. Take notice of this especially when the **MACRO** switch is in the “SLOW” position.
- Once you press a macro key, you must keep the remote control transmitter directed at the main unit’s remote control sensor until the remote control transmitter finishes transmitting all command signals of the macro key.
- You can use the **OPERATION CONTROL** keys also while using the macro functions.

# LEARNING A NEW FUNCTION

- 1** Place this remote control transmitter and the other remote control transmitter so that they face each other.

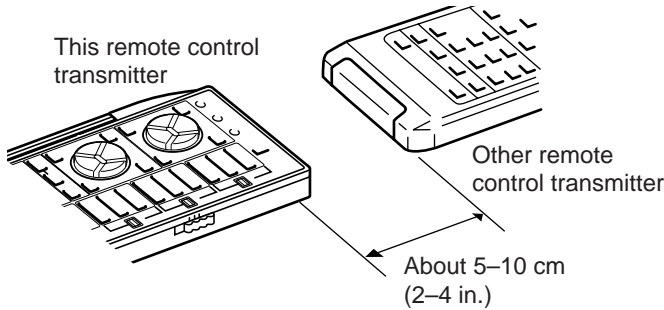

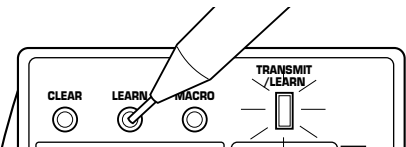
- 2**  (Press by using the point of a mechanical pencil, etc.) **Flashes slowly.**

- \* If there is no operation for about 30 seconds after the **LEARN** button is pressed, the **TRANSMIT/LEARN** indicator flashes rapidly and the current mode is canceled. If this occurs, repeat this step.

- 3** If necessary, select the memory area by using the A/B/C switch on the side panel of the remote control transmitter.

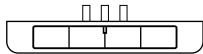

- 4** Press the key on this remote control transmitter in which you will store a new function.

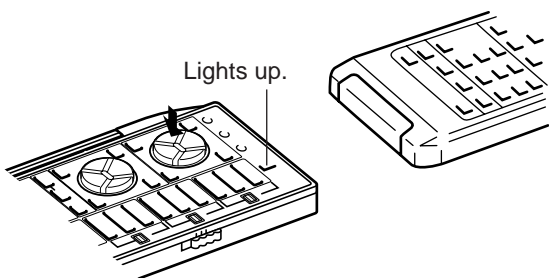

- \* If a key which cannot learn another function is pressed, the **TRANSMIT/LEARN** indicator flashes rapidly and the current mode is canceled. If this occurs, repeat this step.  
\* If there is no operation for about 30 seconds after a key is pressed, the **TRANSMIT/LEARN** indicator flashes rapidly and the mode before you began learning operations is restored. If this occurs, restart from step 2.

- 5** Press and hold the key (on the other remote control transmitter) which has the function you want to store.

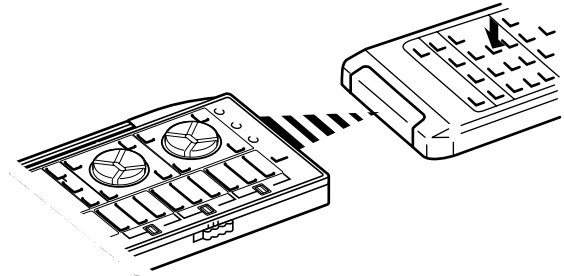

When learning is finished, the **TRANSMIT/LEARN** indicator stops lighting. You can release the key. Then the indicator begins flashing slowly.

- \* If a signal is not successfully received, the **TRANSMIT/LEARN** indicator flashes rapidly and the mode prior to step 4 is restored. If this occurs, restart from step 4.  
\* If memory capacity is full, the **TRANSMIT/LEARN** indicator flashes rapidly to show you that learning is impossible, and then the mode before you began learning operations is restored.

- 6** Repeat step 3-5 to store more functions.

- 7** When you finish the learning operation, press the **LEARN** button.

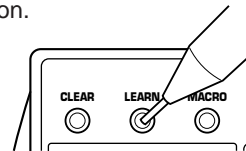

## Notes

- Newly learned functions will replace previously learned functions.
- If there is no more room in the memory area for a function to be learned, the **TRANSMIT/LEARN** indicator will flash rapidly. In this case, even if some keys are not occupied with functions from other remote control transmitters, no further learning is possible.
- If the lid is closed while learning and about 5 seconds pass, the **TRANSMIT/LEARN** indicator flashes rapidly and the mode before you began learning operations is restored. If this occurs, restart from step 2. However, if the lid is opened within 5 seconds, the mode before the lid was closed is restored.
- There may occasionally be instances in which, due to the signal-coding and modulation employed by the other remote control transmitter, this remote control transmitter will not be able to "learn" its signals.

## MAKING A NEW MACRO

A new macro can be programmed onto any preset macro key in place of preset functions. (See page 48 to know what keys are preset macro keys.) You can make as many as 13 new macro keys. A macro key can learn as many as seven functions of other keys.

### Note

If you store a continuous command such as lowering of volume level, it will become a short command when it is carried out as a part of macro.

# 1

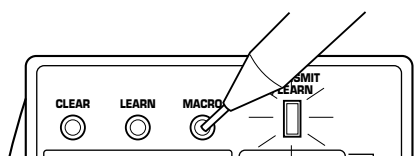

Flashes slowly.

- \* If there is no operation for about 30 seconds after the **MACRO** button is pressed, the **TRANSMIT/LEARN** indicator flashes rapidly and the mode before you pressed the **MACRO** button is restored. If this occurs, press the **MACRO** button again.

# 2

Press a preset macro key on which you want to make a new macro.



Lights up.

- \* If a key other than a preset macro key is pressed, the **TRANSMIT/LEARN** indicator flashes rapidly and the current mode is canceled. If this occurs, repeat this step.

# 3

Press and hold a key whose function you want to store as the first function of the new macro.

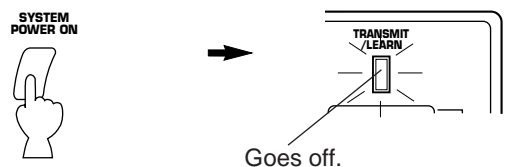

Goes off.

When learning is finished, the **TRANSMIT/LEARN** indicator lights up again. You can release the key.

- \* If a key whose function cannot be stored as a command of macro is pressed, the **TRANSMIT/LEARN** indicator flashes rapidly and the current mode is canceled. If this occurs, repeat this step.
- \* If about 30 seconds pass before a key is pressed, the **TRANSMIT/LEARN** indicator flashes rapidly and the mode before you began learning operations is restored. If this occurs, restart from step 1.

# 4

Repeat step 3 to store the second, the third and more functions. You can store up to seven key functions in series as a macro.

- \* If the seventh key function has been learned, the **TRANSMIT/LEARN** indicator flashes rapidly and the mode before you began learning operations is restored. (This shows that the key has completed learning a series of functions as a macro.) If this occurs, you do not have to follow the next step.

# 5

When you finish learning, press the **MACRO** button.

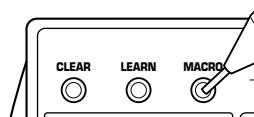

It is recommended to write down new key functions you stored on the provided user function stickers and paste them on the reverse side of the remote control transmitter or the reverse side of the remote control transmitter's lid.

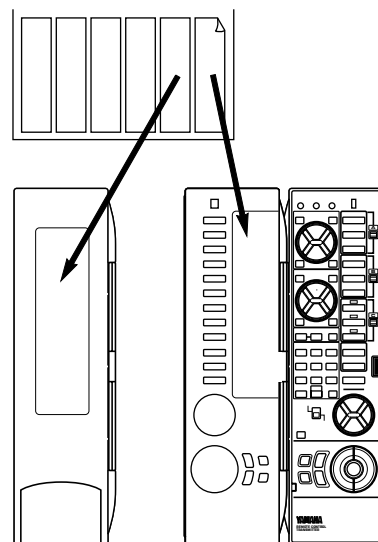

### Memory back-up

All of the learned functions will be retained while you replace the batteries. However, if no batteries are installed for a few hours, the learned functions will be erased and will have to be learned again.

# CLEARING LEARNED FUNCTIONS

## To Clear a Learned Function

- 1 To clear a learned key function, press the **LEARN** button using the point of a mechanical pencil, etc.  
To clear a macro you made, press the **MACRO** button.

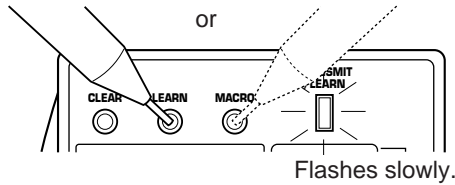

- 2 Press and hold the **CLEAR** button using the point of a mechanical pencil, etc.

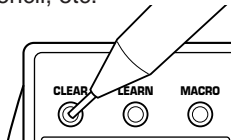

- 3 Holding the **CLEAR** button pressed, press and hold the key whose function you want to clear until the indicator flashes 3 times.

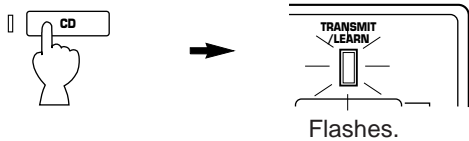

To clear two or more functions sequentially, do not release the **CLEAR** button pressed, and repeat this step.

### Note

If you clear a learned function of a key, the originally preset function of the key is restored (except the keys which are originally preset with no function.)

## To Clear All Learned Functions

- 1 Select the kind of key functions all of which you want to clear by using the **MACRO** switch on the side panel of the remote control transmitter.

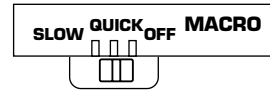

- OFF:** Select this position if you want to clear all of the learned functions except macros.  
**QUICK:** Select this position if you want to clear all of the macros you made only.  
**SLOW:** Select this position if you want to clear all of the learned functions including macros.

- 2 Press the **CLEAR** button using the point of a mechanical pencil, etc.

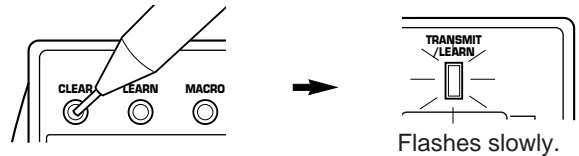

- \* If one of the following operation is made after you press the **CLEAR** button, the TRANSMIT/LEARN indicator flashes rapidly and the current mode is canceled. If this occurs, press the **CLEAR** button again.
- **MACRO** switch is switched to another position.
  - Another key is pressed.
  - There is no operation for about 30 seconds.

- 3 Press and hold the **CLEAR** button again. While holding the **CLEAR** button pressed, press and hold the **MASTER VOLUME** ^ and v keys simultaneously until the indicator flashes 7 times.

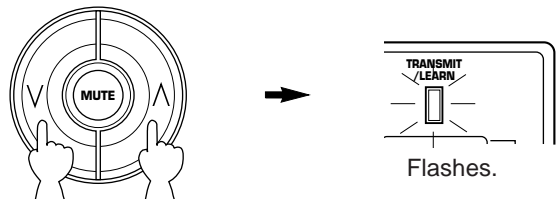

## Trouble shooting guide

SYMPTOM	CAUSE	REMEDY
The remote control transmitter does not work.	The batteries of this remote control transmitter are weak. The internal microcomputer "freezes".	Replace the batteries with new ones and press the RESET button on the remote control transmitter.
Learning cannot be made successfully. (The TRANSMIT/LEARN indicator does not light up or flash.)	The batteries of this remote control transmitter and/or the other remote control transmitter are weak.	Replace the batteries (and press the RESET button for this remote control transmitter).
	The distance between the two remote control transmitters is too long or too short.	Place the remote control transmitters with the proper distance.
	The signal coding or modulation of the other remote control transmitter is not compatible with this remote control transmitter.	Learning is not possible.
	Memory capacity is full.	Further learning is not possible without deleting unnecessary commands.
	The internal microcomputer "freezes".	Press the RESET button on the remote control transmitter.

# TROUBLESHOOTING

If the unit fails to operate normally, check the following points to determine whether the fault can be corrected by the simple measures suggested. If it cannot be corrected, or if the fault is not listed in the SYMPTOM column, disconnect the power cord and contact your authorized YAMAHA dealer or service center for help.

	SYMPTOM	CAUSE	REMEDY
Amplifier	<b>The unit fails to turn on when the STANDBY/ON switch is pressed, or turns into the standby mode suddenly soon after the power is turned on.</b>	Power cord is not plugged in or is not completely inserted.	Firmly plug in the power cord.
		The IMPEDANCE SELECTOR switch on the rear panel is not set to the upper or the lower end closely.	Set the switch to the upper or the lower end closely.
	<b>It happens that this unit does not work normally.</b>	There is an influence of strong external noise (lightning, excessive static electricity, etc.) or a misoperation on this unit while using this unit.	Turn this unit into the standby mode and disconnect the AC power cord from the AC outlet. After about 30 seconds have passed, connect the power and operate this unit again.
	<b>No sound or no picture.</b>	Incorrect output cord connections.	Connect the cords properly. If the problem persists, the cords may be defective.
		Appropriate input source is not selected.	Select an appropriate input source with the input selector buttons.
		The SPEAKERS switches are not set properly.	Set the SPEAKERS switch which corresponds to the speakers to be used to the ON position.
		Speaker connections are not secure.	Secure the connections.
	<b>No picture</b>	There is no S video terminal connection between this unit and the TV, though S video signals are input to this unit.	Connect this unit's S VIDEO MONITOR OUT terminal to the TV's S video input terminal.
	<b>The sound suddenly goes off.</b>	The protection circuit has been activated because of short circuit etc.	Turning the unit into the standby mode and then on will reset the protection circuit.
		The SLEEP timer has functioned.	Cancel the SLEEP timer function.
	<b>Only one side speaker outputs the sound.</b>	Incorrect setting of the BALANCE control.	Adjust it to the appropriate position.
		Incorrect cord connections.	Connect the cords properly. If the problem persists, the cords may be defective.
	<b>Sound "hums".</b>	Incorrect cord connections.	Firmly connect the audio plugs. If the problem persists, the cords may be defective.
		No connection from the turntable to the GND terminal.	Make the GND connection between the turntable and this unit.
	<b>The volume level is low while playing a record.</b>	The record is being played on a turntable with an MC cartridge.	The player should be connected to the unit through the MC head amplifier.
	<b>The volume level cannot be increased, or sound is distorted.</b>	The component connected to the REC OUT terminals of this unit is in the standby mode.	Turn the power to the component on.
	<b>No sound from the rear speakers.</b>	The sound output level to the rear speakers is set to minimum.	Raise the sound output level to the rear speakers.
		The monaural sound source is played in DOLBY PRO LOGIC or DOLBY PRO LOGIC ENHANCED mode.	Select another program suitable for the monaural sound source.
<b>No sound from the center speaker.</b>	The sound output level to the center speaker is set to minimum.	Raise the sound output level to the center speaker.	
	The center channel mode is in PHANTOM mode.	Select NORMAL or WIDE.	
	Incorrect sound field program selection.	Select the appropriate program.	

	SYMPTOM	CAUSE	REMEDY
FM	FM stereo reception is noisy.	Because of the characteristics of FM stereo broadcasts, this is limited to cases where the transmitter is too far away or the antenna input is poor.	Check the antenna connections. Try using a high quality directional FM antenna. Set the TUNING MODE button to the manual tuning mode.
	There is distortion and clear reception cannot be obtained even with a good FM antenna.	There is multipath interference.	Adjust antenna placement to eliminate multipath interference.
	A desired station cannot be tuned in with the automatic tuning method.	The station is too weak.	Use the manual tuning method. Use a high quality directional FM antenna.
	Previously preset stations can no longer be tuned in.	This unit has been unplugged for a long period.	Repeat the presetting procedure.
AM	A desired station cannot be tuned in with the automatic tuning method.	Weak signal or loose antenna connections.	Tighten the AM loop antenna connections and rotate it for best reception. Use the manual tuning method.
	There are continuous crackling and hissing noises.	Noises will result from lightning, fluorescent lamps, motors, thermostats and other electrical equipment.	Use an outdoor antenna and a ground wire. This will help somewhat but it is difficult to eliminate all noise.
	There are buzzing and whining noises (especially in the evening).	A television set is being used nearby.	Relocate this unit away from the TV.
Remote control transmitter	The remote control transmitter does not work.	Direct sunlight or lighting (of an inverter type of fluorescent lamp etc.) is striking the remote control sensor of the main unit.	Change the position of the main unit.
		The batteries of this remote control transmitter are too weak.	Replace the batteries with new ones.
Others	The sound is degraded when listening with the headphones connected to the compact disc player or cassette deck that are connected with this unit.	This unit is in the standby mode.	Turn the power to this unit on.



# SPECIFICATIONS

## AUDIO SECTION

Minimum RMS Output Power per Channel	
MAIN L/R	8 ohms, 20 Hz to 20 kHz, 0.04% THD .....80W+80W
CENTER	8 ohms, 20 Hz to 20 kHz, 0.07% THD .....80W
REAR L/R	8 ohms, 20 Hz to 20 kHz, 0.07% THD .....80W+80W
Maximum Power [China and General models only]	
8 ohms, 1 kHz, 10% THD	MAIN L/R .....125W+125W
Dynamic Power per Channel (by IHF Dynamic Headroom measuring method)	
MAIN L/R	8/6/4/2 ohms .....100/125/150/175W
Dynamic Headroom (8 ohms) [U.S.A. and Canada models only]	.....0.96 dB
IEC Power [Singapore model only]	
8 ohms, 1 kHz, 0.04% THD	MAIN L/R .....95W
Power Band Width	
MAIN L/R	8 ohms, 40W, 0.09% THD .....10 Hz to 50 kHz
Damping Factor (SPEAKERS A)	
MAIN L/R	8 ohms, 20 Hz to 20 kHz .....80 or more
Input Sensitivity/Impedance	
PHONO MM.....	2.5 mV/47 k-ohms
CD/TAPE-MD/DVD-LD/TV-DBS/VCR	
/VIDEO AUX.....	150 mV/47 k-ohms
Maximum Input Signal	
PHONO MM	1 kHz, 0.04% THD.....110 mV or more
CD/TAPE-MD/DVD-LD/TV-DBS/VCR	
/VIDEO AUX (EFFECT ON)	1 kHz, 0.5% THD.....2.2V or more
Output Level/Impedance	
REC OUT.....	150 mV/2.7 k-ohms
PRE OUT.....	2.6V/1.1 k-ohms
SUBWOOFER (MAIN SPEAKER: SMALL)	
.....	4V/1.2 k-ohms
Headphones Jack Rated Output/Impedance	
Output Level	(CD/TAPE-MD/DVD-LD/TV-DBS/VCR /VIDEO AUX Input, 150 mV, RL=8 ohms) .....0.5V
Impedance	.....390 ohms

Frequency Response (20 Hz to 20 kHz)	
CD/TAPE-MD/DVD-LD/TV-DBS/VCR	
/VIDEO AUX to MAIN L/R SP OUT	.....0±0.5 dB
RIAA Equalization Deviation	
PHONO MM	.....0±0.5 dB
Total Harmonic Distortion (20 Hz to 20 kHz)	
PHONO MM to REC OUT	
1V	.....0.02% or less
CD/TAPE-MD/DVD-LD/TV-DBS/VCR	
/VIDEO AUX to SP OUT (EFFECT OFF)	
40W/8 ohms	.....0.025% or less
Signal-to-Noise Ratio (IHF-A Network)	
PHONO MM to REC OUT	
(5 mV Input Shorted)	.....86 dB or more
CD/TAPE-MD/DVD-LD/TV-DBS/VCR	
/VIDEO AUX to SP OUT (EFFECT OFF)	
(150 mV Input Shorted)	.....96 dB or more
Residual Noise (IHF-A Network)	
MAIN L/R SP OUT	.....170 µV or less
Channel Separation (Vol. -30 dB, EFFECT OFF)	
PHONO MM	
(Input Shorted, 1 kHz/10 kHz)	.....60 dB or more/55 dB or more
CD/TAPE-MD/DVD-LD/TV-DBS/VCR	
/VIDEO AUX	
(Input 5.1 k-ohms Shorted, 1 kHz/10 kHz)	.....60 dB or more/45 dB or more
Tone Control Characteristics	
BASS: Boost/cut	.....±10 dB (50 Hz)
Turnover Frequency	.....350 Hz
TREBLE: Boost/cut	.....±10 dB (20 kHz)
Turnover Frequency	.....3.5 kHz

Filter Characteristics	
MAIN L/R, REAR L/R (MAIN SPEAKER: SMALL)	
(H.P.F.)	.....fc = 90 Hz, 12 dB/oct.
SUBWOOFER	
(L.P.F.)	.....fc = 90 Hz, 18 dB/oct.
Gain Tracking Error (0 to -60 dB)	
MAIN L/R	.....3 dB or less
Bass Extension	.....+6 dB (50 Hz)

## VIDEO SECTION

Video Signal Type	
[U.S.A. and Canada models].....	NTSC
[Australia and Singapore models].....	PAL
[China and General models].....	NTSC/PAL
Video Signal Level	.....1 Vp-p/75 ohms

S-Video Signal Level	
Y	.....1 Vp-p/75 ohms
C	.....0.286 Vp-p/75 ohms
Maximum Input Level	.....1.5 Vp-p or more
Signal-to-Noise Ratio	.....50 dB or more
Monitor Output Frequency Response	.....5 Hz to 10 MHz, -3 dB

## FM SECTION

Tuning Range	
[U.S.A. and Canada models]	.....87.5 to 107.9 MHz
[Australia, Singapore, China and General models].....	87.5 to 108.0 MHz
50 dB Quieting Sensitivity (IHF) (100% mod., 1 kHz)	
Mono	.....1.55 µV (15.1 dBf)
Stereo	.....21 µV (37.7 dBf)
Image Response Ratio	
[U.S.A., Canada, China and General models]	.....45 dB
[Australia and Singapore models].....	80 dB
IF Response Ratio	
[U.S.A., Canada, China and General models]	.....70 dB
[Australia and Singapore models].....	80 dB
Spurious Response Ratio	.....70 dB
AM Suppression Ratio	.....55 dB
Capture Ratio	.....1.5 dB
Alternate Channel Selectivity (±400 kHz)	
[U.S.A., Canada, China and General models only]	.....85 dB
Selectivity (two signals, 40 kHz Dev. ±300 kHz) [Australia and Singapore models only]	.....70 dB
Signal-to-Noise Ratio (IHF) Mono/Stereo	
[U.S.A., Canada, China and General models]	.....80 dB/75 dB
(DIN-Weighted, 40 kHz Dev.) Mono/Stereo	
[Australia and Singapore models]	.....75 dB/70 dB
Harmonic Distortion (1 kHz)	
Mono/Stereo	.....0.1/0.2%
Stereo Separation	.....50 dB
Frequency Response	
20 Hz to 15 kHz	.....0 ±1.5 dB

## AM SECTION

Tuning Range	
[U.S.A., Canada, China and General models]	530 to 1,710 kHz
[Australia and Singapore models]	531 to 1,611 kHz
Usable Sensitivity	100 µV/m
Selectivity	32 dB
Signal-to-Noise Ratio	50 dB
Image Response Ratio	40 dB
Spurious Response Ratio	50 dB
Harmonic Distortion (1 kHz)	0.3%

## AUDIO SECTION

Output Level/Impedance	
FM (100% mod., 1 kHz)	500 mV/2.2 k-ohms
[U.S.A. and Canada models]	
[Australia, Singapore, China and General models (40 kHz Dev.)]	400 mV/2.2 k-ohms
AM (30% mod., 1 kHz)	150 mV/2.2 k-ohms

## GENERAL

Power Supply	
[U.S.A. and Canada models]	AC 120V, 60 Hz
[Australia model]	AC 240V, 50 Hz
[Singapore model]	AC 230V, 50 Hz
[China and General models]	AC 110/120/220/240V, 50/60 Hz
Power Consumption	
[U.S.A. model]	300W
[Canada model]	350W/420 VA
[Australia, Singapore, China and General models]	350W
Maximum Power Consumption [General model only]	690W
AC Outlets	
2 SWITCHED OUTLETS	
[U.S.A., Canada, Singapore, China and General models]	100W max. total
1 SWITCHED OUTLET	
[Australia model]	100W max. total
Dimensions (W x H x D)	
	435 x 151 x 391 mm
	(17-1/8" x 5-15/16" x 15-3/8")

## Weight

[U.S.A. and Canada models]	12.0 kg (26 lbs. 6 oz.)
[Australia, Singapore, China and General models]	13.0 kg (28 lbs. 10 oz.)

Accessories	AM loop antenna
	Indoor FM antenna
	Remote control transmitter
	Batteries
	User function stickers
	Antenna adapter
	(U.S.A. and Canada models only)

Specifications are subject to change without notice.

## SECTION AM

### Gamme de syntonisation

[Modèles pour les Etats-Unis, le Canada, la Chine et général] .....530 à 1.710 kHz  
[Modèles pour l'Australie et Singapour] .....531 à 1.611 kHz

Sensibilité utilisable.....100 µV/m

Sélectivité.....32 dB

Rapport signal/bruit.....50 dB

Rapport de réponse d'image.....40 dB

Rapport de réponse de bruit .....50 dB

Distorsion harmonique (1 kHz).....0,3%

## SECTION AUDIO

### Niveau de sortie/impédance

FM (100% mod., 1 kHz)

[Modèles pour les Etats-Unis et le Canada] .....500 mV/2,2 k-ohms

[Modèles pour l'Australie, Singapour, la Chine et général (40 kHz Dev.)] .....400 mV/2,2 k-ohms

AM (30% mod., 1 kHz)

.....150 mV/2,2 k-ohms

## GENERALES

### Alimentation

[Modèles pour les Etats-Unis et le Canada] .....CA 120V, 60 Hz  
[Modèle pour l'Australie].....CA 240V, 50 Hz  
[Modèle pour Singapour].....CA 230V, 50 Hz  
[Modèles pour la Chine et général] .....CA 110/120/220/240V, 50/60 Hz

### Consommation

[Modèle pour les Etats-Unis] .....300W  
[Modèle pour le Canada] .....350W/420 VA  
[Modèles pour l'Australie, Singapour, la Chine et général] .....350W

Consommation maximale [Modèle général seulement].....690W

### Prises CA

2 prises commutées  
[Modèles pour les Etats-Unis, le Canada, Singapour, la Chine et général] .....100W max. au total

1 prise commutée  
[Modèle pour l'Australie] .....100W max. au total

### Dimensions (L x H x P)

.....435 x 151 x 391 mm

### Poids

[Modèles pour les Etats-Unis et le Canada] .....12,0 kg  
[Modèles pour l'Australie, Singapour, la Chine et général].....13,0 kg

Accessoires.....Cadre-antenne AM

Antenne FM intérieure

Emetteur de télécommande

Piles

Etiquettes de fonctions d'utilisateur

Adaptateur d'antenne (Modèles pour les Etats-Unis et le Canada seulement)

Caractéristiques techniques modifiables sans préavis.