

YAMAHA

CC-90

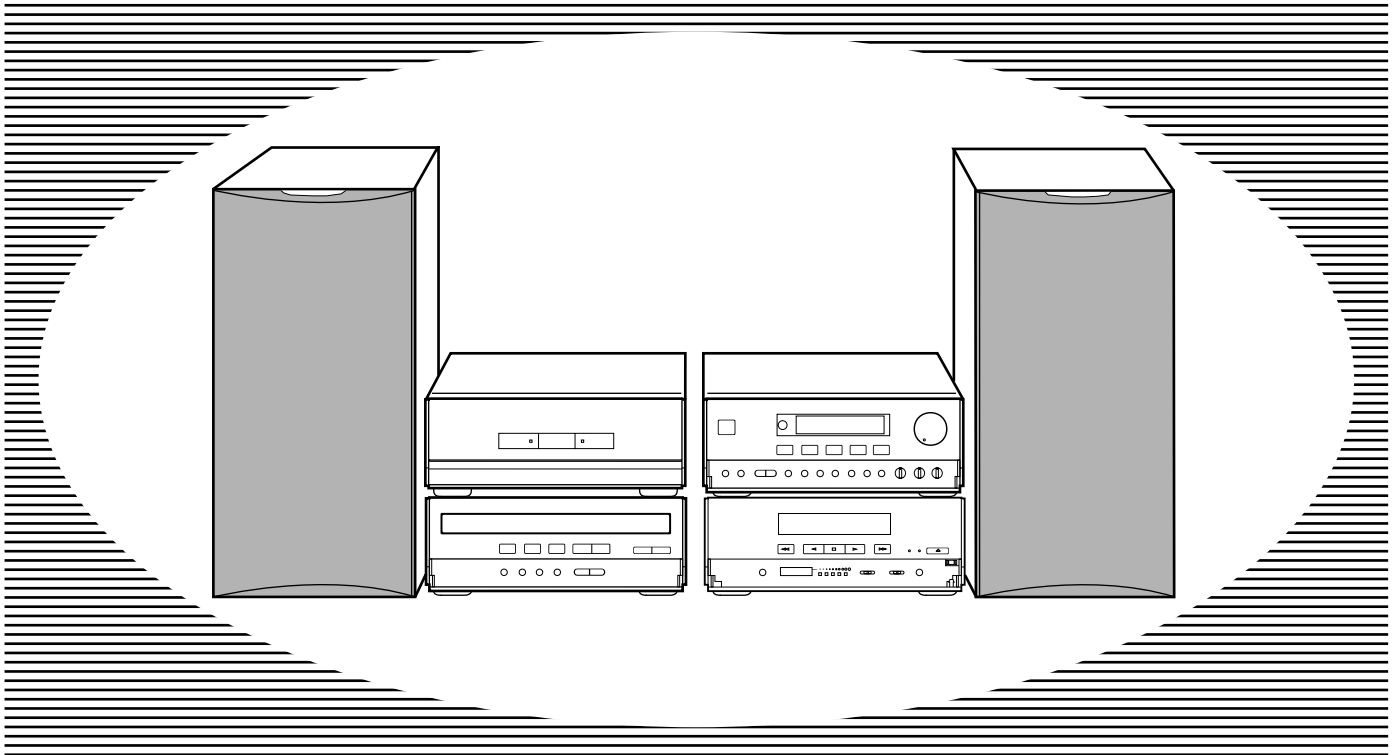

Natural Sound Mini Component System



CC-90 is composed of CTX-S90, MX-S90, CDC-S90, KX-S90 and NX-S90.



OWNER'S MANUAL

IMPORTANT!

Please record the serial number of this unit in the space below.

Model:
Serial No.:

The serial number is located on the rear of the unit.
Retain this Owner's Manual in a safe place for future reference.

CONTENTS

	Page
SAFETY INSTRUCTIONS.....	Inside Front Cover-1
INTRODUCTION.....	2
FEATURES.....	2
SUPPLIED ACCESSORIES.....	2
PRECAUTIONS.....	3
NAMES OF CONTROLS, INDICATORS AND REAR PANEL PARTS.....	4-6
REMOTE CONTROL TRANSMITTER.....	7-9
REMOVING THE FRONT GRILLE (for Speaker System NX-S90 only).....	9
PREPARATION FOR USE.....	10-12
OPEN/CLOSE THE CONTROL DOOR.....	13
TURNING THE POWER ON/OFF TO THIS SYSTEM.....	13
SETTING THE CLOCK.....	14

	Page
SOUND CONTROL.....	15
COMPACT DISC PLAYER OPERATION.....	15-22
TUNING OPERATION.....	23-25
TAPE DECK OPERATION.....	26-28
RECORDING COMPACT DISCS.....	29-34
OTHER RECORDINGS.....	35-36
HOW TO USE THE BUILT-IN TIMER.....	37-40
USING EXTERNAL UNITS.....	41-42
MAINTENANCE.....	42
SPECIFICATIONS.....	43
TROUBLESHOOTING.....	44
ACTIVE SERVO TECHNOLOGY (for Speaker System NX-S90 only).....	45

SAFETY INSTRUCTIONS (for U.S. customers)

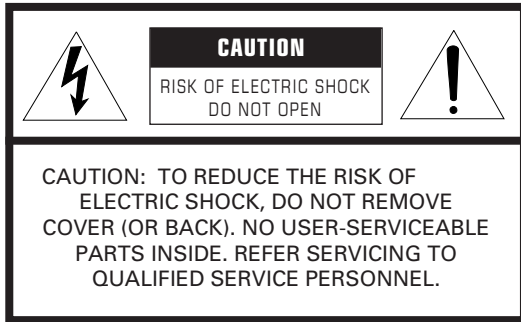

• Explanation of Graphical Symbols

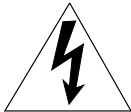

The lightning flash with arrowhead symbol, within an equilateral triangle, is intended to alert you to the presence of uninsulated "dangerous voltage" within the product's enclosure that may be of sufficient magnitude to constitute a risk of electric shock to persons.



The exclamation point within an equilateral triangle is intended to alert you to the presence of important operating and maintenance (servicing) instructions in the literature accompanying the appliance.



- 1 Read Instructions – All the safety and operating instructions should be read before the unit is operated.
- 2 Retain Instructions – The safety and operating instructions should be retained for future reference.
- 3 Heed Warnings – All warnings on the unit and in the operating instructions should be adhered to.
- 4 Follow Instructions – All operating and other instructions should be followed.
- 5 Water and Moisture – The unit should not be used near water – for example, near a bathtub, washbowl, kitchen sink, laundry tub, in a wet basement, or near a swimming pool, etc.
- 6 Carts and Stands – The unit should be used only with a cart or stand that is recommended by the manufacturer.
- 6A A unit and cart combination should be moved with care. Quick stops, excessive force, and uneven surfaces may cause the unit and cart combination to overturn.
- 7 Wall or Ceiling Mounting – The unit should be mounted to a wall or ceiling only as recommended by the manufacturer.
- 8 Ventilation – The unit should be situated so that its location or position does not interfere with its proper ventilation. For example, the unit should not be situated on a bed, sofa, rug, or similar surface, that may block the ventilation openings; or placed in a built-in installation, such as a bookcase or cabinet that may impede the flow of air through the ventilation openings.
- 9 Heat – The unit should be situated away from heat sources such as radiators, stoves, or other appliances that produce heat.



- 10 Power Sources – The unit should be connected to a power supply only of the type described in the operating instructions or as marked on the unit.
- 11 Power-Cord Protection – Power-supply cords should be routed so that they are not likely to be walked on or pinched by items placed upon or against them, paying particular attention to cords at plugs, convenience receptacles, and the point where they exit from the unit.
- 12 Cleaning – The unit should be cleaned only as recommended by the manufacturer.
- 13 Nonuse Periods – The power cord of the unit should be unplugged from the outlet when left unused for a long period of time.
- 14 Object and Liquid Entry – Care should be taken so that objects do not fall into and liquids are not spilled into the inside of the unit.
- 15 Damage Requiring Service – The unit should be serviced by qualified service personnel when:
 - A. The power-supply cord or the plug has been damaged; or
 - B. Objects have fallen, or liquid has been spilled into the unit; or
 - C. The unit has been exposed to rain; or
 - D. The unit does not appear to operate normally or exhibits a marked change in performance; or
 - E. The unit has been dropped, or the cabinet damaged.
- 16 Servicing – The user should not attempt to service the unit beyond those means described in the operating instructions. All other servicing should be referred to qualified service personnel.
- 17 Power Lines – An outdoor antenna should be located away from power lines.
- 18 Grounding or Polarization – Precautions should be taken so that the grounding or polarization is not defeated.
- 19 Outdoor Antenna Grounding – If an outside antenna is connected to this unit, be sure the antenna system is grounded so as to provide some protection against voltage surges and built-up static charges. Article 810 of the National Electrical Code, ANSI/NFPA 70, provides information with regard to proper grounding of the mast and supporting structure, grounding of the lead-in wire to an antenna discharge unit, size of grounding conductors, location of antenna discharge unit, connection to grounding electrodes, and requirements for the grounding electrode.

EXAMPLE OF ANTENNA GROUNDING

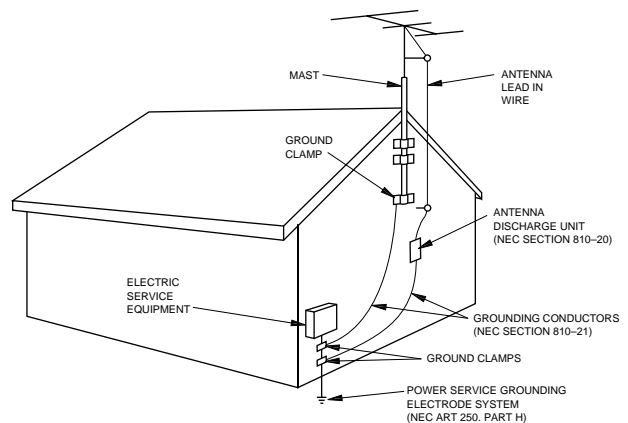

NEC – NATIONAL ELECTRICAL CODE

Note to CATV system installer:

This reminder is provided to call the CATV system installer's attention to Article 820-40 of the NEC that provides guidelines for proper grounding and, in particular, specifies that the cable ground shall be connected to the grounding system of the building, as close to the point of cable entry as practical.

SPECIAL NOTES FOR FCC COMPOSITE DEVICE

This device is a composite system. The digital device component may not cause harmful interference.

FCC INFORMATION**1. IMPORTANT NOTICE : DO NOT MODIFY THIS UNIT!**

This product, when installed as indicated in the instructions contained in this manual, meets FCC requirements. Modifications not expressly approved by Yamaha may void your authority, granted by the FCC, to use the product.

2. IMPORTANT : When connecting this product to accessories and/or another product use only high quality shielded cables. Cable/s supplied with this product **MUST** be used. Follow all installation instructions. Failure to follow instructions could void your FCC authorization to use this product in the USA.**3. NOTE :** This product has been tested and found to comply with the requirements listed in FCC Regulations, Part 15 for Class "B" digital devices. Compliance with these requirements provides a reasonable level of assurance that your use of this product in a residential environment will not result in harmful interference with other electronic devices.

This equipment generates/uses radio frequencies and, if not installed and used according to the instructions found in the users manual, may cause interference harmful to the operation of other electronic devices.

Compliance with FCC regulations does not guarantee that interference will not occur in all installations. If this product is found to be the source of interference, which can be determined by turning the unit "OFF" and "ON", please try to eliminate the problem by using one of the following measures:

Relocate either this product or the device that is being affected by the interference.

Utilize power outlets that are on different branch (circuit breaker or fuse) circuits or install AC line filter/s.

In the case of radio or TV interference, relocate/reorient the antenna. If the antenna lead-in is 300 ohm ribbon lead, change the lead-in to coaxial type cable.

If these corrective measures do not produce satisfactory results, please contact the local retailer authorized to distribute this type of product. If you can not locate the appropriate retailer, please contact Yamaha Electronics Corp., U.S.A. 6660 Orangethorpe Ave, Buena Park, CA 90620.

The above statements apply **ONLY** to those products distributed by Yamaha Corporation of America or its subsidiaries.

We Want You Listening For A Lifetime

YAMAHA and the Electronic Industries Association's Consumer Electronics Group want you to get the most out of your equipment by playing it at a safe level. One that lets the sound come through loud and clear without annoying blaring or distortion – and, most importantly, without affecting your sensitive hearing.

Since hearing damage from loud sounds is often undetectable until it is too late, YAMAHA and the Electronic Industries Association's Consumer Electronics Group recommend you to avoid prolonged exposure from excessive volume levels.



INTRODUCTION

Thank you for purchasing this YAMAHA product. We hope it will give you many years of trouble-free enjoyment. For the best performance, read this manual carefully. It will guide you in operating your YAMAHA product.

FEATURES

- 70W + 70W (6Ω) RMS Output Power, 0.04 THD, 20–20,000 Hz
- 3-CD Carousel Auto Changer
- **PLAYXCHANGE:** Disc Changing Capability while Playing Another
- Random Access Programmable CD Playback
- Single Track/Entire Disc/All Disc Repeat Play
- 3-Disc Random Play
- Automatic Synchronized Recording with CD Playback
- Automatic CD Editing Function for Recording to Tape
- Continuous Tape Playback Capability by Automatic Reversing Function
- Dolby B/C Noise Reduction and HX PRO Bias Servo System
- 40 Station Automatic Preset Tuning
- Multi-Use Timer/Sleep Timer
- Active Servo Processing Speaker System (NX-S90)
- Remote Control Capability

SUPPLIED ACCESSORIES

After unpacking, check that the following parts are contained.

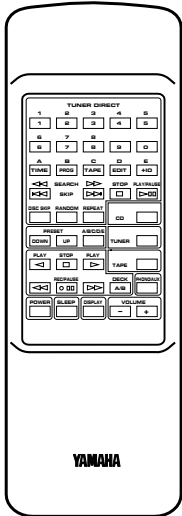
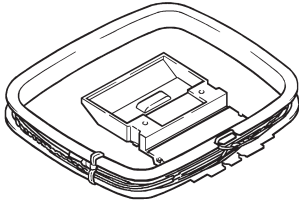
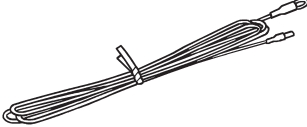
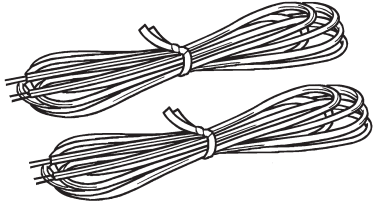
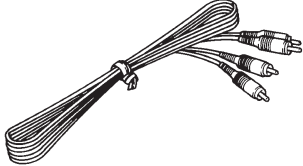
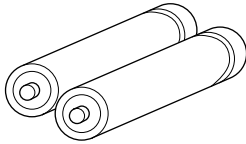
<p>Remote control transmitter</p> 	<p>AM (MW/LW) loop antenna</p> 	<p>Indoor FM antenna</p> 
	<p>Speaker cords (for NX-S90)</p> 	<p>Audio connection cord</p> 
		<p>Batteries (size AA, UM/SUM-3, R6, HP-7)</p> 

PRECAUTIONS: READ THIS BEFORE OPERATING YOUR UNIT

- To assure the finest performance, please read this manual carefully. Keep it in a safe place for future reference.
- Choose the installation location of this unit carefully. Avoid placing it in direct sunlight or close to a source of heat. Also avoid locations subject to vibration and excessive dust, heat, cold or moisture. Keep it away from sources of hum such as transformers and electric motors.
- Do not operate this unit upside-down. It may overheat, possibly causing damage.
- Never open the cabinet. If something drops into the set, contact your dealer
- The openings on the cabinet assure proper ventilation of the unit. If these openings are obstructed, the temperature inside the cabinet will rise rapidly and eventually damage the circuits. Therefore, avoid placing objects against these openings and do not install the unit where the flow of air through the ventilation openings could be impeded.
- Always set the VOLUME control to "0" before starting the audio source play: increase the volume gradually to an appropriate level after the play has been started.
- When not planning to use this unit for long periods of time (ie., vacation, etc.), disconnect the AC power plug from the wall outlet.
- Grounding or polarization – Precautions should be taken so that the grounding or polarization of an appliance is not defeated.
- Do not use force on switches, controls or connection wires. When moving the unit, first disconnect the power plug and the wires connected to other equipment. Never pull the wire itself.
- Do not attempt to clean the unit with chemical solvents; this might damage the finish. Use a clean, dry cloth.
- Be sure to read the "TROUBLESHOOTING" section regarding common operating errors before concluding that the unit is faulty.
- To prevent lightning damage, disconnect the AC power plug and the antenna cable when there is an electrical storm.
- Do not plug the AC power plug to the wall socket before you finish all connections.
- Never allow metallic items (e.g. screwdrivers, tools, etc.) to come near the cassette deck's record/playback head assembly in this unit. Doing so may not only scratch or damage the head's mirror-smooth finish, it may change the magnetic characteristics of the heads, causing a deterioration in reproduction performance quality.
- Although the cassette deck's record/playback heads used in this unit are high quality heads with outstanding reproduction characteristics, they can become dirty through the use of old tapes or from dust accumulation over time. This can have a serious effect on reproduction quality. Clean the heads regularly with one of the commonly available head cleaners or with cleaning solutions.
- The voltage to be used must be the same as that specified on this unit. Using this product with a higher voltage than that which is specified is dangerous and may result in a fire or other type of accident causing damage. YAMAHA will not be held responsible for any damage resulting from use of this unit with a voltage other than that which is specified.
- The sound level at a given volume setting depends on a combination of speaker efficiency, location and many other factors. Care should be taken to avoid exposure to sudden high levels of sound, which may occur when turning on the unit with the volume control setting at high, and to continuous high levels of sound.

- Sudden temperature changes and storage or operation in an extremely humid environment may cause condensation inside the cabinet.
Condensation can cause the unit to malfunction.
Follow the procedure below to eliminate condensation.
 - **CD pickup**
Leave the power on with no disc in the unit until normal playback is possible (about 1 hour).
 - **Tape head**
Leave the power on with no cassette in the unit until normal playback is possible (about 1 hour).
Note
If condensation forms on the tape head, foreign matter may accumulate during use.
 - **Remote control**
Wipe off condensation on the transmitter window with a soft cloth before operating the unit.

NOTE

Please check the copyright laws in your country to record from records, compact discs, radio, etc. Recording of copyright material may infringe copyright laws.

CAUTION FOR CARRYING THE CD PLAYER

Be sure not to carry or tip the CD player with discs remaining in it.

WARNING

DANGER

Invisible laser radiation when open and interlock failed or defeated. Avoid direct exposure to beam.

CAUTION

Use of controls or adjustments or performance of procedures other than those specified herein may result in hazardous radiation exposure.

As the laser beam used in this compact disc player is harmful to the eyes, do not attempt to disassemble the cabinet. Refer servicing to qualified personnel only.

To avoid electrical shock, do not open the cabinet. Refer servicing to qualified personnel only.

DANGER: The use of optical instrument with this product will increase eye hazard.

Laser Diode Properties

- Material: GaAlAs
- Wavelength: 780nm
- Emission Duration: continuous
- Laser Output: max. 44.6 μ W*

* This output is the value measured at a distance of about 200mm from the objective lens surface on the Optical Pick-up Block.

NAMES OF CONTROLS, INDICATORS AND REAR PANEL PARTS

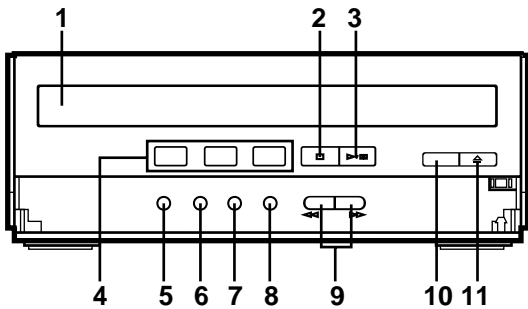

CD Player (CDC-S90)

1. Disc Table
2. Stop Button: □
3. Play/Pause Button: ▷/⏸
4. Disc Select Buttons
5. **TIME** Button
6. **EDIT** Button
7. **REPEAT** Button
8. **RANDOM** Play Button
9. **SKIP** Buttons: ◀◀/▶▶
(**SEARCH** Buttons: ◀◀/▶▶)
10. **PLAYXCHANGE** Button
11. **OPEN/CLOSE** Button: ▲
12. Disc Indicator
13. Tape Side Indicator
14. **EDIT** Indicator
15. Track Number Indicator
16. Time Display
17. (**S, F, A**) **REPEAT** Indicator
18. **RANDOM** Play Indicator
19. **PROGRAM** Indicator
20. Music Calendar Indicator
21. Music Calendar **OVER** Indicator
22. Play Indicator: ▷

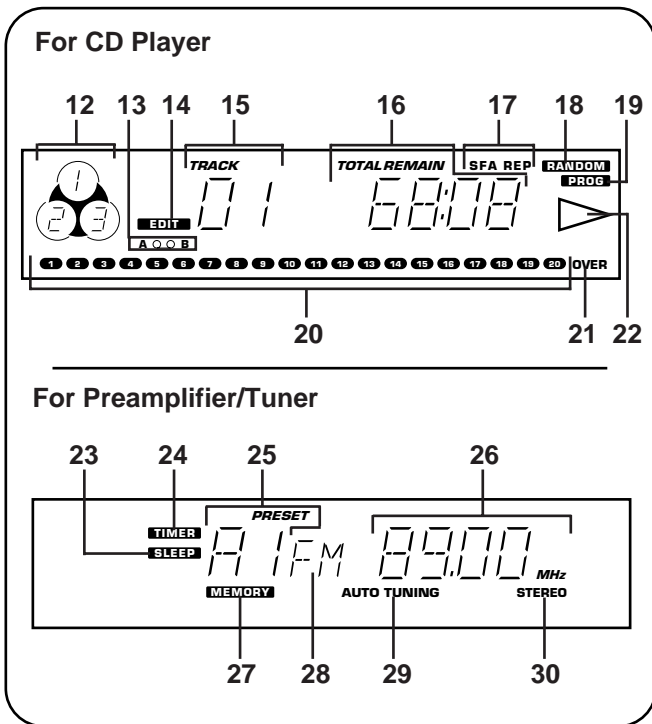

Preamplifier/Tuner (CTX-S90)

23. **SLEEP** Indicator
24. **TIMER** Set Indicator
25. Preset Number Indicator
26. Station Frequency Indicator
27. **MEMORY** Indicator
28. Band Indicator
29. **AUTO TUNING** Indicator
30. **STEREO** Indicator
31. **POWER** Switch
32. Remote Control Sensor
33. Input Selector Buttons
34. **VOLUME** Control
35. **PHONES** Jack
36. **DISPLAY** Button
37. **TUNER PRESET DOWN/UP** Buttons
38. **A/B/C/D/E (TIMER)** Button
39. **MEMORY (TIME ADJUST)** Button
40. Tuning **DOWN (HOUR)** Button
41. Tuning **UP (MINUTE)** Button
42. **AUTO/MAN'L (SEC)** Button
43. **BAND** Selector Button
44. **AUTO MEMORY** Button
45. **BASS** Tone Control
46. **TREBLE** Tone Control
47. **BALANCE** Control

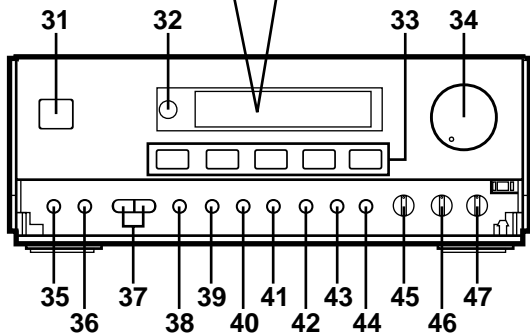

NAMES OF CONTROLS, INDICATORS AND REAR PANEL PARTS

Power Amplifier (MX-S90)

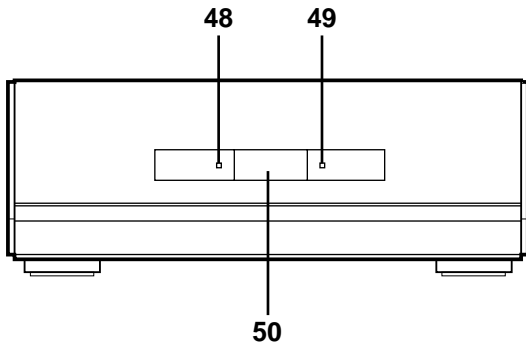

- 48. **POWER** Indicator
- 49. **CLIPPING** Indicator
- 50. **POWER** Switch

Cassette Tape Deck (KX-S90)

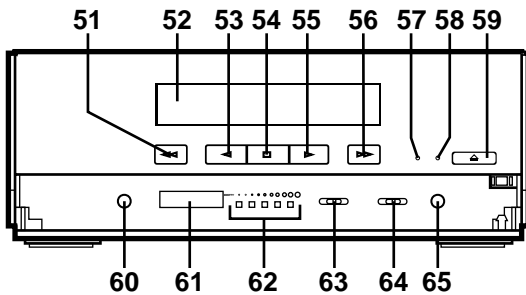

- 51. Fast Wind Button: <<
- 52. Cassette Compartment
- 53. Play Button and Play Direction Indicator: ◁
- 54. Stop Button: □
- 55. Play Button and Play Direction Indicator: ▷
- 56. Fast Wind Button: ▷▷
- 57. **PLAY** Indicator
- 58. **REC** Indicator
- 59. **OPEN/CLOSE** Button: △
- 60. **RESET** Button
- 61. Tape Counter (**LINEAR COUNTER**)
- 62. **REMAIN** Indicators
- 63. Dolby **NR** Switch
- 64. Reverse Mode Switch
- 65. **REC/PAUSE** Button

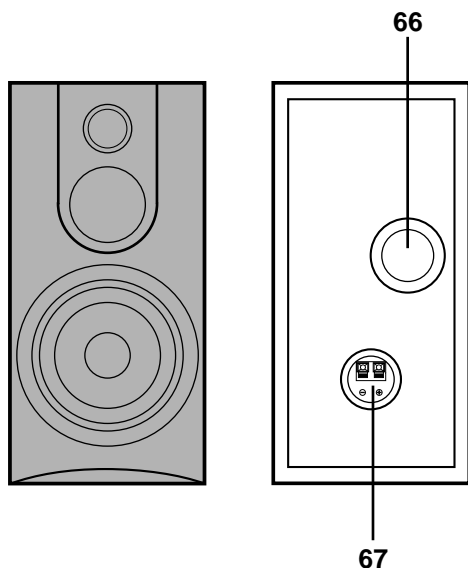

Speakers (NX-S90)

(For Europe model, NX-S90 is optional in some areas.)

- 66. YST Port
- 67. Speaker Terminals

NAMES OF CONTROLS, INDICATORS AND REAR PANEL PARTS

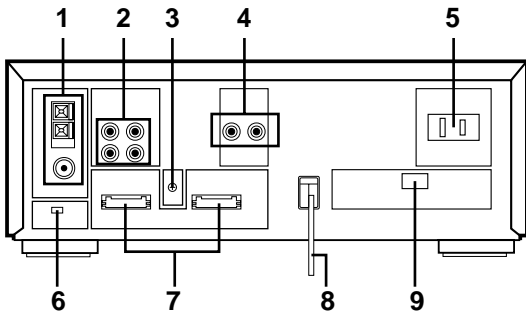

Rear Panel of Preamplifier/Tuner (CTX-S90)

1. Antenna Terminals
2. **INPUT (PHONO and AUX)** Terminals
3. **GND** Terminal
4. **PRE OUT** Terminals
5. **AC OUTLET**
(The shape of the AC OUTLET is different according to the destination of the model.)
6. **FREQUENCY STEP** Switch (General model only)
7. System Control Sockets
8. AC Supply Lead
9. **VOLTAGE SELECTOR** (General model only)

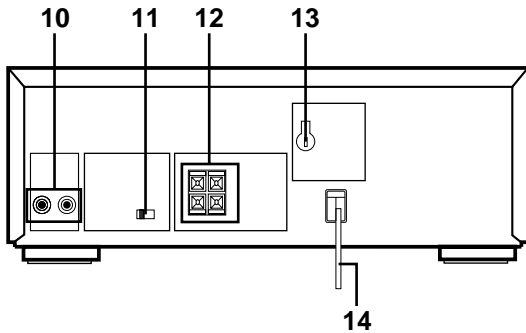

Rear Panel of Power Amplifier (MX-S90)

10. **INPUT** Terminals
11. **SPEAKERS SELECTOR** Switch
12. **SPEAKERS** Terminals
13. **VOLTAGE SELECTOR** (General model only)
14. AC Supply Lead

SPEAKERS SELECTOR switch

If you connect YAMAHA NX-S90 speaker system to this unit, set this switch to "NX-S90".
If you connect a speaker system other than NX-S90 to this unit, set this switch to "CONVENTIONAL".

FREQUENCY STEP switch (General model only)

Because the interstation frequency spacing differs in different areas, set the FREQUENCY STEP switch (located at the rear) according to the frequency spacing in your area. Before setting this switch, disconnect the AC supply lead of this unit from the AC outlet.

VOLTAGE SELECTOR (General model only)

The voltage selector on the rear panel of this unit must be set for your local main voltage **BEFORE** plugging into the AC main supply.

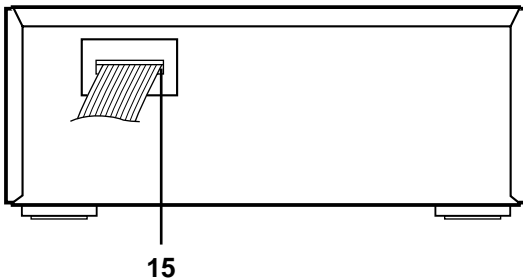

Rear Panel of Cassette Tape Deck (KX-S90)

15. System Control Connector

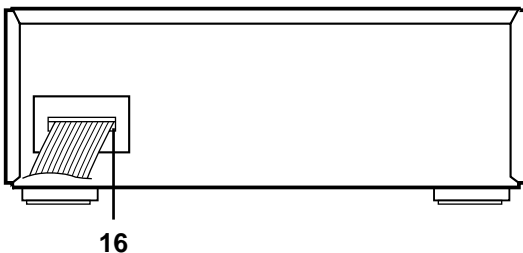

Rear Panel of CD Player (CDC-S90)

16. System Control Connector

Names of control buttons

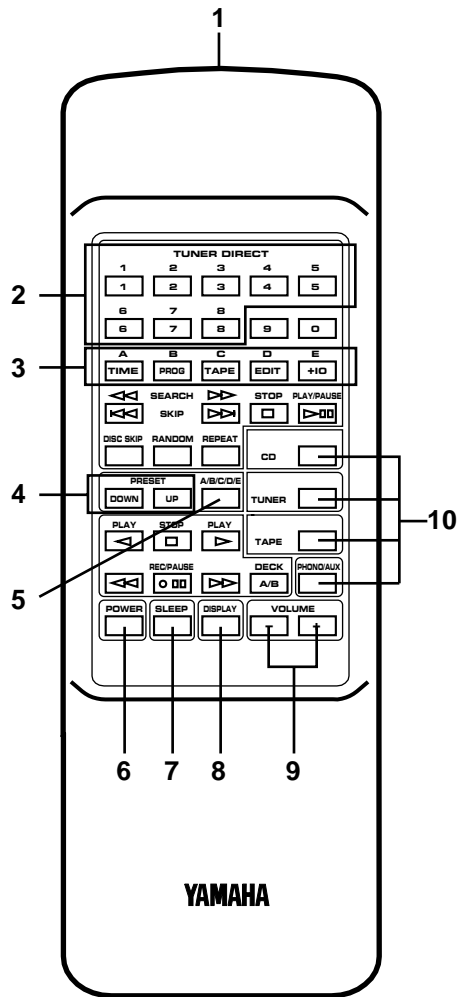

■ Preamplifier/Tuner Control Buttons

1. Remote Control Transmitter Window
2. Preset Station Number Buttons
3. A, B, C, D, E Selector Buttons
4. PRESET DOWN/UP Buttons
5. A/B/C/D/E Button
6. POWER Switch
7. SLEEP Button
8. DISPLAY Button
9. VOLUME Down (-)/Up (+) Buttons
10. Input Selector Buttons

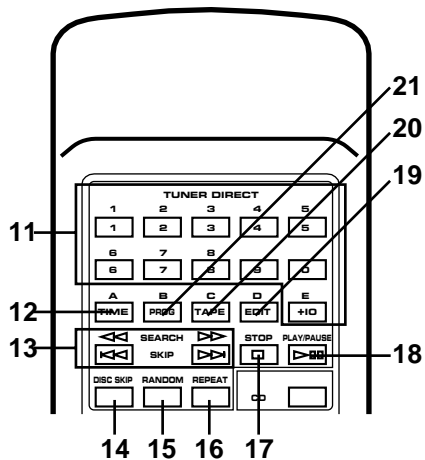

■ CD Player Control Buttons

11. Track Number Input Buttons
12. TIME Button
13. SEARCH Buttons: \ll / \gg
(SKIP Buttons: \ll / \gg)
14. DISC SKIP Button
15. RANDOM Button
16. REPEAT Button
17. STOP Button: \square
18. PLAY/PAUSE Button: $\triangleright \square$
19. EDIT Button
20. TAPE Button
21. PROGRAM Button

REMOTE CONTROL TRANSMITTER

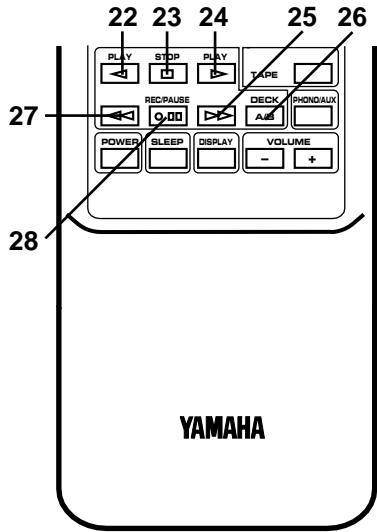

■ Tape Deck Control Buttons

- 22. Play Button: ◁
- 23. Stop Button: □
- 24. Play Button: ▷
- 25. Fast Wind Button: ▷▷
- 26. (This button is unnecessary for this system.)
- 27. Fast Wind Button: ◁◁
- 28. REC/PAUSE Button: ◯ ▯

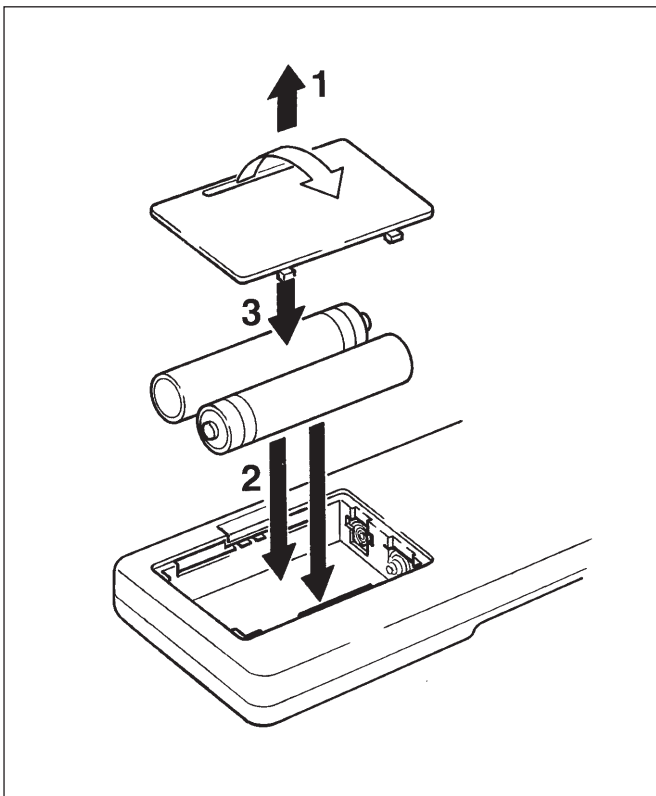

Loading the batteries for the remote control transmitter

- 1 Remove the battery compartment cover.
(Press the left edge of the cover to right with a finger, and then pull it upward.)
- 2 Insert 2 "AA" size batteries (UM/SUM-3, R6, HP-7 or equivalent) into the battery compartment.
* Installing the batteries improperly may cause failure.
- 3 Replace the battery compartment cover.

Precautions for battery use

- Insert the batteries according to the direction indicated in the battery compartment.
- Replace all batteries with new ones at the same time.
- Remove the batteries if they are weak or if the unit is not in use for long periods.
- Don't mix normal batteries with rechargeable batteries.

REMOTE CONTROL TRANSMITTER

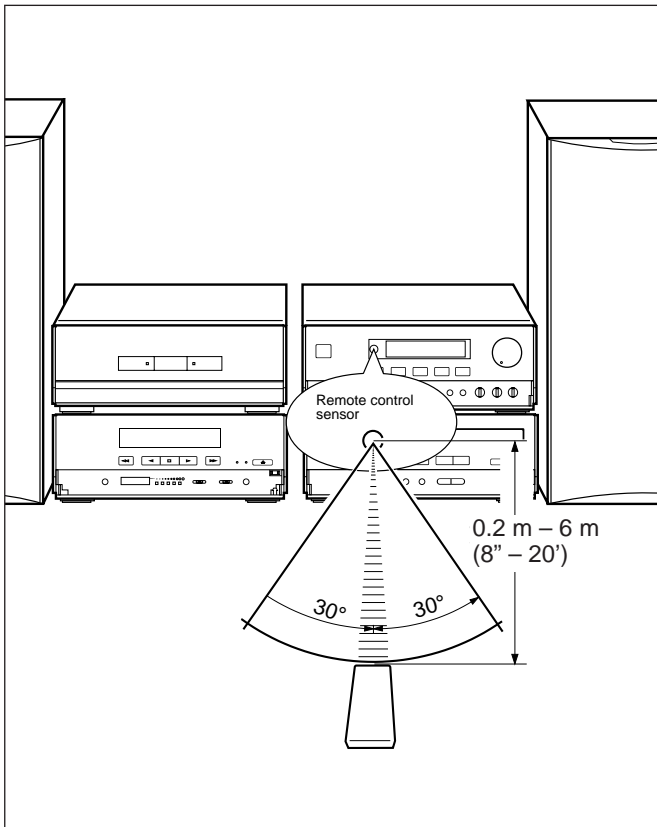

Proper use of the remote control transmitter

Aim (within the range of 60° with no obstacles) the remote control transmitter at the remote control sensor and operate as shown.

Notes concerning use

- Replace the batteries if control distance decreases or operation becomes unstable.
- Periodically clean the transmitter window on the remote control transmitter and the sensor on the main unit with a soft cloth.
- Exposing the sensor on the main unit to strong light (especially an inverter type of fluorescent lamp etc.) may interfere with operation. In this case, reposition the main unit to avoid direct lighting.
- Keep the remote control transmitter away from moisture, excessive heat, shock and vibrations.
- The remote control transmitter's usable range is within 0.2m (8") and 6m (20') away from the sensor.

REMOVING THE FRONT GRILLE (for Speaker System NX-S90 only)

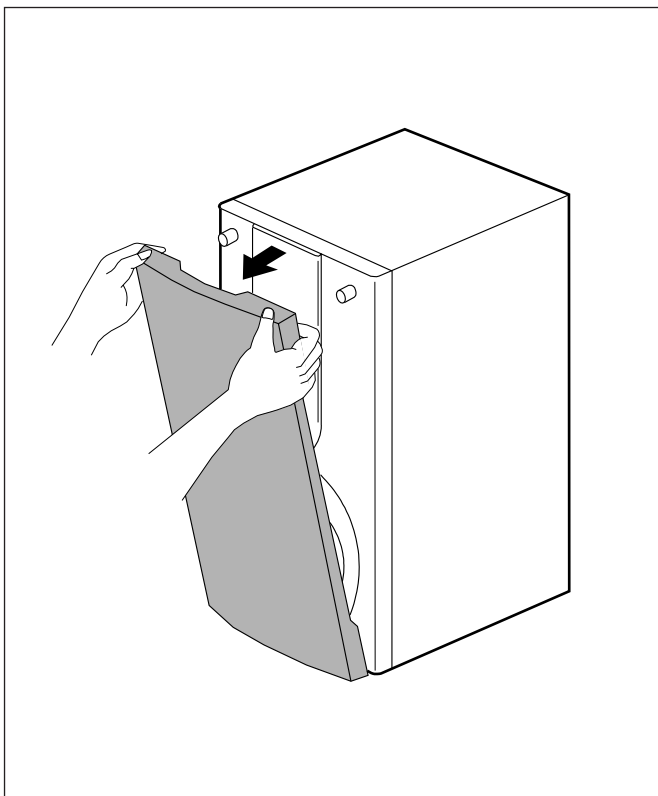

The front grille is fastened to the enclosure at four points, and can be removed if desired. To remove the grille, hold on to both sides and slowly pull straight away from the speaker. To reattach, line up the four pegs on the speaker with the four corresponding holes on the inside surface of the grille and push gently.

Note

When the grille is removed, take care not to touch the speaker units with your hands or to exert excessive force with tools.

PREPARATION FOR USE

Placing example

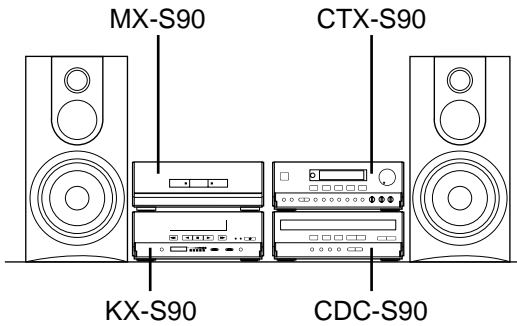

Placing the system

This system can be placed any way you like, however, be sure not to place another unit or any object on top of the power amplifier (MX-S90) to prevent the ventilation holes on the top panel of it from being obstructed. If doing so, it may damage the unit.

Notes

- If the system is put in a rack, allow a space of at least 5 cm (1-15/16") above and behind the unit.
- Disconnect the AC supply lead from the AC outlet before connecting or disconnecting any component.

Antenna connection

(1) Supplied FM antenna

Connect the FM antenna wire to the corresponding terminal and direct the FM antenna wire to the direction where the strongest signal can be received.

(2) Supplied AM (MW/LW) loop antenna

Connect the AM (MW/LW) loop antenna wire to the corresponding terminals. Position the AM (MW/LW) loop antenna for optimum reception. Place the AM (MW/LW) loop antenna on a shelf etc., or install it on the rack or wall with screws (not supplied).

Notes

- When static is still heard even after adjusting the position of the AM (MW/LW) loop antenna, try reversing the connection (top to bottom).
- Do not place the AM (MW/LW) loop antenna on the unit. It will result in noise generation, since the unit is equipped with digital electronics. Place the AM (MW/LW) loop antenna away from the unit.

(3) External FM antenna

Use an external FM antenna instead of an indoor FM antenna if you need better reception. Consult your dealer.

(4) External AM (MW/LW) antenna

Use an external AM (MW/LW) antenna if you need better reception. Consult your dealer.

Note

When using an external AM (MW/LW) antenna, be sure to keep the wire of the AM (MW/LW) loop antenna connected.

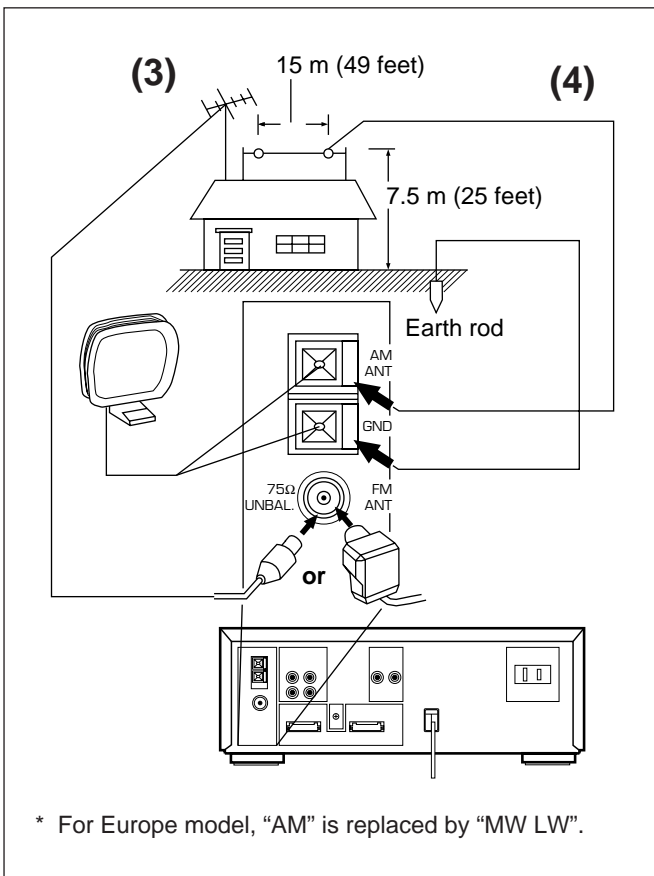
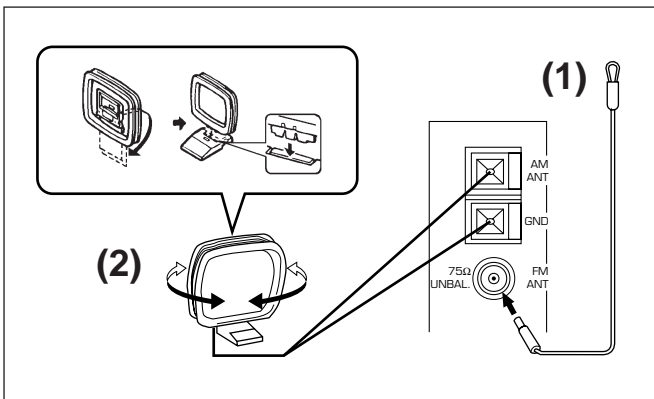

PREPARATION FOR USE

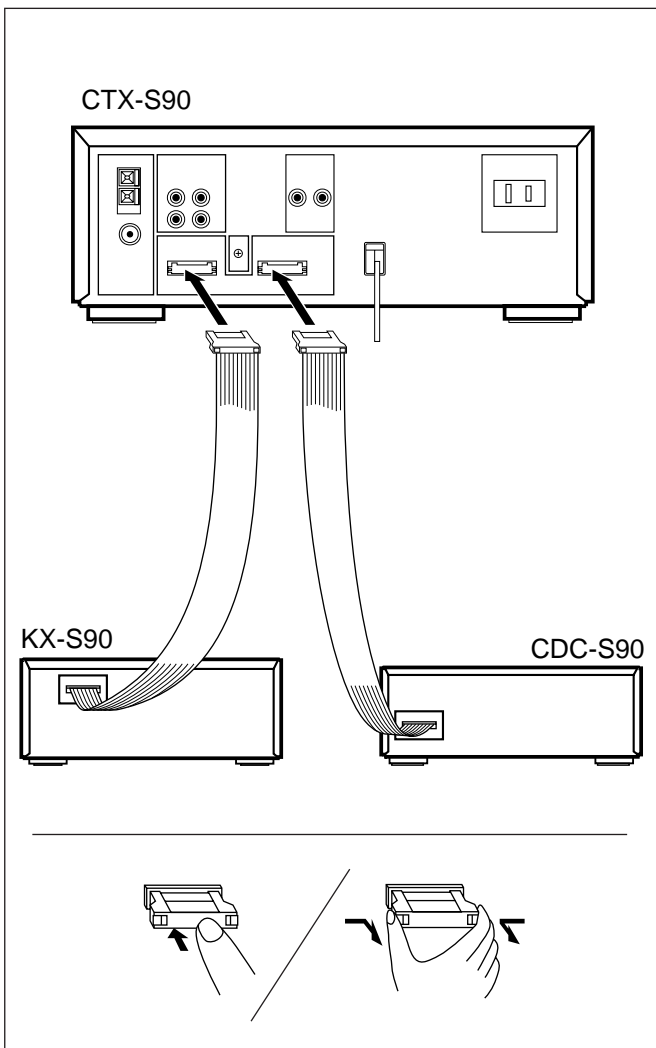

System connection

- Connect the red connector on the rear of CDC-S90 to the red socket on the rear of CTX-S90.
- Connect the black connector on the rear of KX-S90 to the black socket.

How to disconnect the system connector

Grasp both sides of the connector to disconnect the connector.

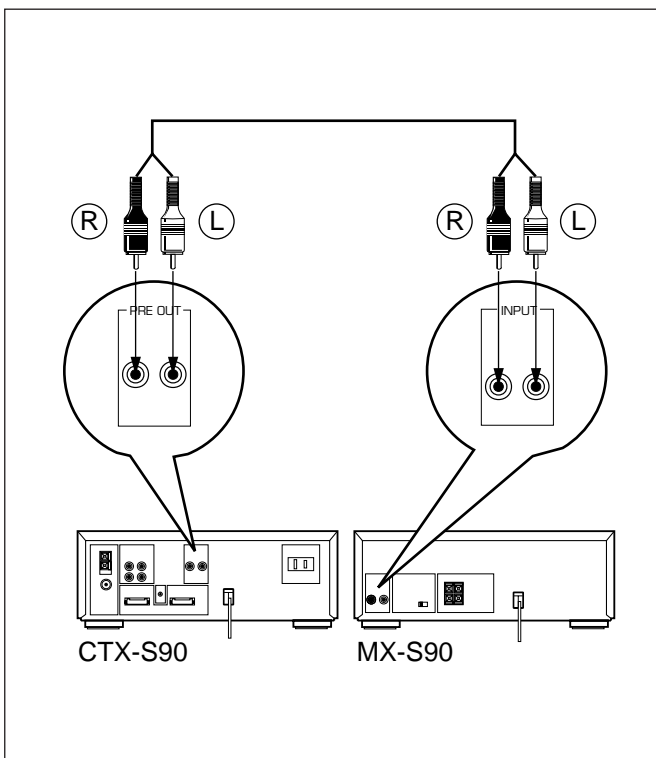

- Connect the PRE OUT terminals on the rear of CTX-S90 to the INPUT terminals on the rear of MX-S90 by using the supplied pin-type audio connection cords. Make connections correctly from "R" (right) to "R" and from "L" (left) to "L".

PREPARATION FOR USE

For connecting with NX-S90

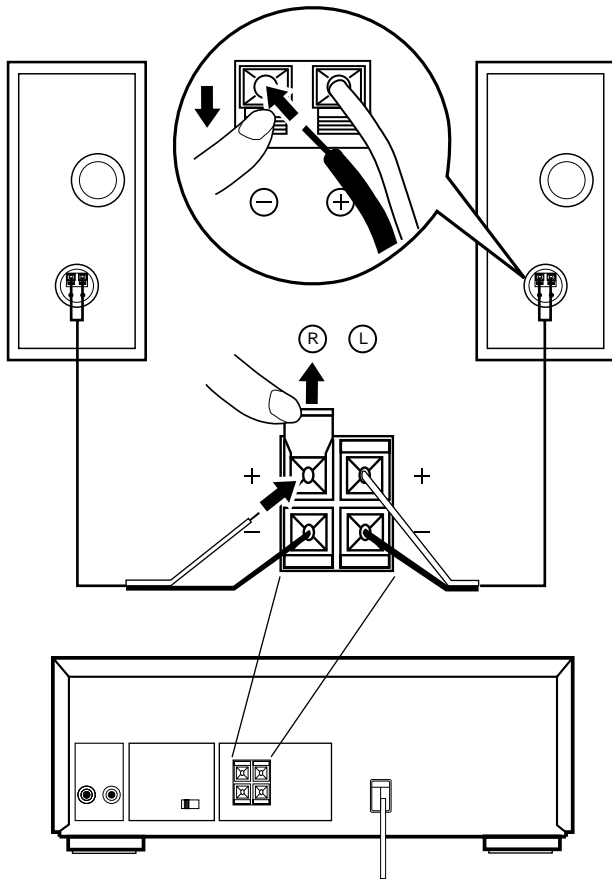

(Black wire with white line → plus (+) terminal,
black wire → minus (-) terminal)

Speaker connection

Connect each speaker wire to the SPEAKERS terminals.

Cautions

- Do not let the bare speaker wires touch each other as this could damage the amplifier and/or speakers.
- When connecting the speakers to this system, be sure to connect the speaker wires properly. Do not mistake the right channel for the left channel and the plus (+) terminal for the minus (-) terminal.
- Set the SPEAKERS SELECTOR switch on the rear panel of MX-S90 to the proper position before connections. If you use YAMAHA Active Servo Processing Speaker System NX-S90, set this switch to "NX-S90". If you use a speaker system other than NX-S90, set this switch to "CONVENTIONAL".

Connecting the AC supply leads

These connections must be done after all other connections have been completed.

- First, plug the AC supply lead of MX-S90 into the AC OUTLET on the rear of CTX-S90.
 - Next, plug the AC supply lead of CTX-S90 into a wall AC outlet.
- * Unplug the AC supply lead of CTX-S90 from the AC outlet if the system is not to be used for a long period of time.

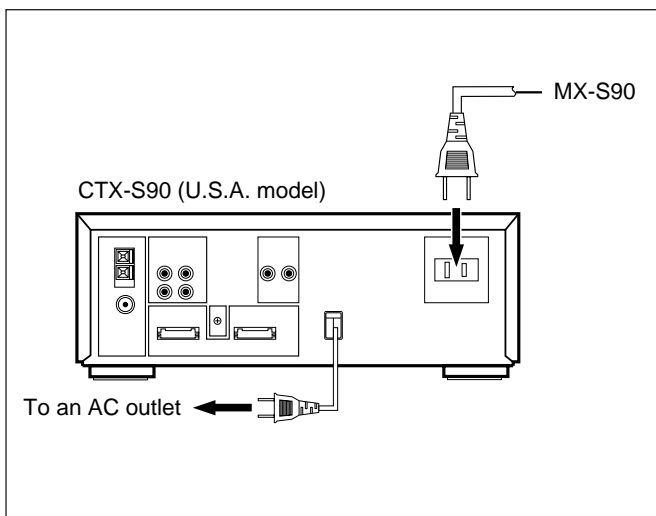

AC OUTLET (SWITCHED) on the rear panel of CTX-S90

Use this to connect the AC supply lead from another component to CTX-S90.

The power to this outlet is controlled by the POWER switch of CTX-S90 or the provided remote control transmitter.

This outlet will supply power to the connected component whenever CTX-S90 is turned on.

The maximum power (power consumption of component) that can be connected to the AC OUTLET (SWITCHED) is 420 watts.

It is the best way to connect the AC supply lead of MX-S90 to this outlet. By doing so, the power of the whole system can be turned on/off by the POWER switch of CTX-S90 or the provided remote control transmitter.

After the connection, keep the POWER switch of MX-S90 in the ON position.

OPEN/CLOSE THE CONTROL DOOR

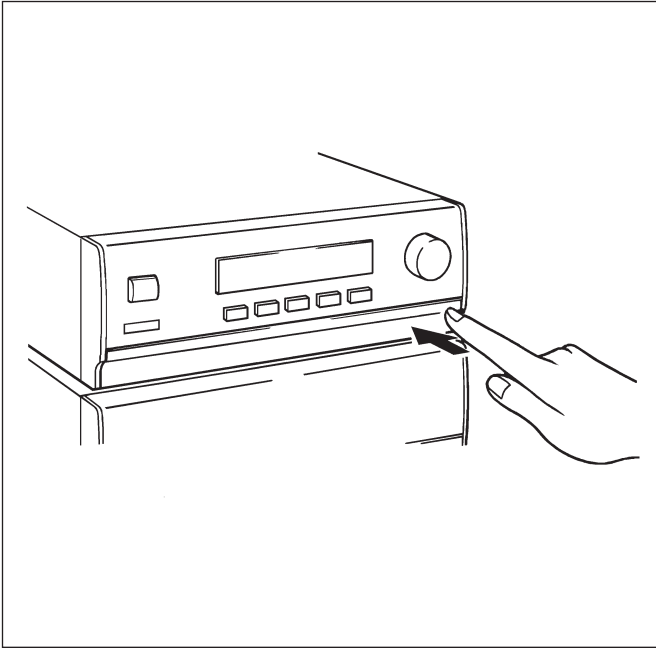

When it is not necessary to operate controls inside the control door, close the door.

To open or close the door, press the right edge until it clicks.

TURNING THE POWER ON/OFF TO THIS SYSTEM

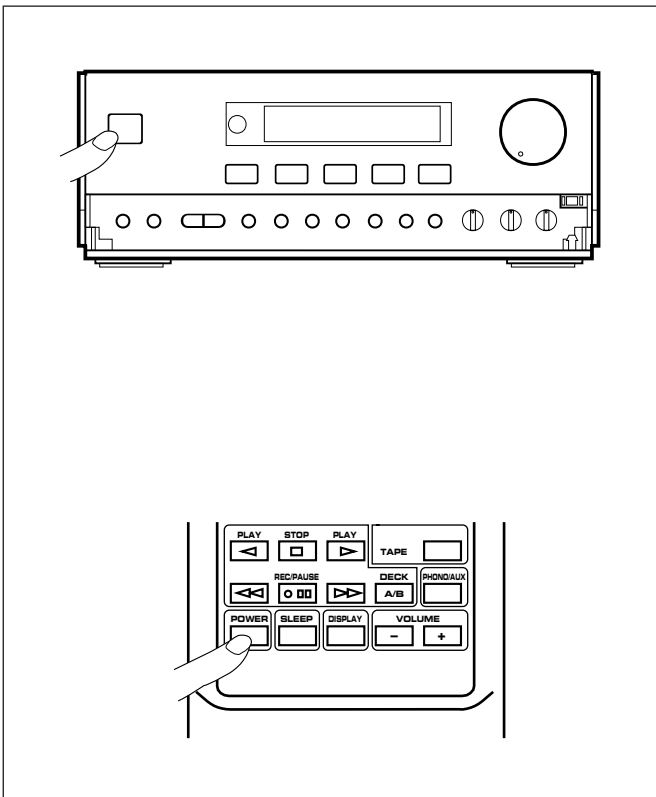

If the AC supply lead of CTX-S90 is connected to the AC outlet, this system can be turned ON and OFF (STANDBY mode) by pressing the POWER switch on the front panel of CTX-S90 or on the remote control transmitter.

* If the AC supply lead of MX-S90 is not connected to the AC OUTLET on the rear panel of CTX-S90, the POWER switch of MX-S90 must also be pressed to turn it on separately.

STANDBY mode

While the power is on, pressing the POWER switch (or the POWER switch on the remote control transmitter) switches the system to the STANDBY mode. (In this mode, the display shows only the time.) In this mode, main voltage is still present inside the system. If you want to switch off the system completely, disconnect the AC power plug from the AC outlet.

SETTING THE CLOCK

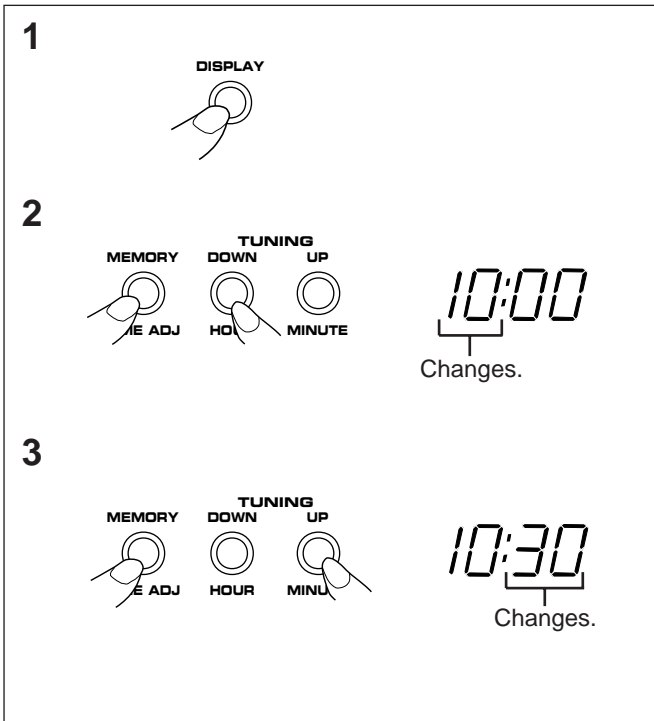

- 1 While the power is on, press the **DISPLAY** button to display the time. If the power is off, you can proceed to the next step.
- 2 While pressing the **TIME ADJUST** button, press the **HOUR** button and set the hour.
 - * Press the **HOUR** button once to advance the time by 1 hour. Press and hold to advance continuously.
- 3 While pressing the **TIME ADJUST** button, press the **MINUTE** button and set the desired time.
 - * Press the **MINUTE** button once to advance the time by 1 minute. Press and hold to advance continuously.
 - * The hour setting will not advance even if the minute advance from "59" to "00".

To display the time by "second"

While pressing the **SEC** button, the current time is displayed by minute and second.

To reset the second to "00"

While pressing the **SEC** button, press the **TIME ADJUST** button.

- * If the current second is lower than 30, it is reset to 00.

- * If the current second is higher than 30, the minute is advanced by 1 minute and the second is reset to 00.

(If the current minute is "59", in this case, the hour is also advanced by 1 hour.)

In the event of a power failure or when the AC supply lead is disconnected.

The time display will go out, however, the clock will function for about 30 minutes without power supply. So you do not have to reset the time if the AC power supply is resumed within about 30 minutes.

When the AC power supply is resumed after more than 30 minutes pass without power supply, the time display will flash on and off to indicate that the time must be reset.

Note

If this system is left for several minutes without setting the time after the AC power lead of this system is connected to the AC outlet, there may be a case that the display is turned into a demonstration mode. (This mode is virtually unnecessary for using this system.)

In this case, first turn the power on by pressing the **POWER** switch to cancel the mode, and then set the time.

SOUND CONTROL

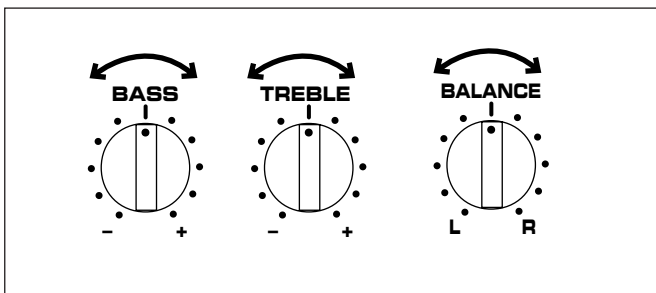
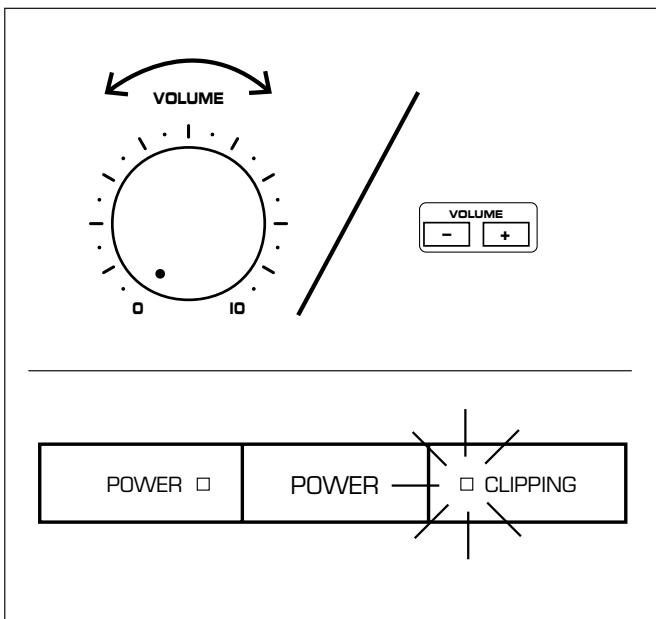

Volume

Front panel operation

Rotate the VOLUME control towards 10 to increase the volume, and towards 0 to decrease the volume.

Remote control operation

Press the VOLUME + button to increase the volume and the VOLUME - button to decrease the volume.

CLIPPING indicator

The CLIPPING indicator illuminates if an overload is applied to this system due to excessive input. In this case, reduce the input level by using the VOLUME control.

Balance

Adjust the balance of the output volume to the left and right speakers to compensate for sound imbalance caused from the speaker settings or the listening room condition.

Turn this clockwise to emphasize the right and counterclockwise for the left.

Tone

BASS : Turn this clockwise to increase (or counterclockwise to decrease) the low frequency response.

TREBLE : Turn this clockwise to increase (or counterclockwise to decrease) the high frequency response.

COMPACT DISC PLAYER OPERATION

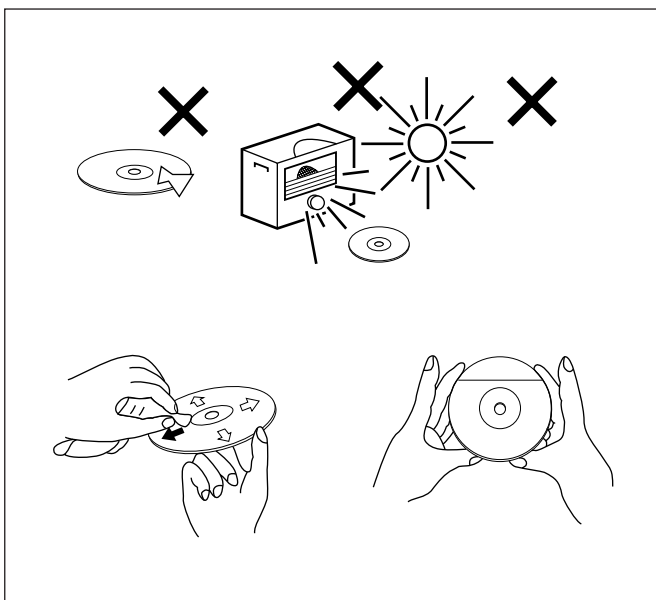

Care of compact discs

Compact discs are fairly resistant to damage, however mistracking can occur due to an accumulation of dirt on the disc surface.

Follow the guidelines below for maximum enjoyment from your CD collection and player.

- Do not write on either side of the disc, particularly the non-label side. Signals are read from the non-label side. Do not mark this surface.
- Keep your discs away from direct sunlight, heat and excessive moisture.
- Always hold the CDs by the edges. Fingerprints, dirt or water on the CDs can cause noise or mistracking. If a CD is dirty or does not play properly, clean it with a soft, dry cloth, wiping straight out from the center, along the radius.

COMPACT DISC PLAYER OPERATION

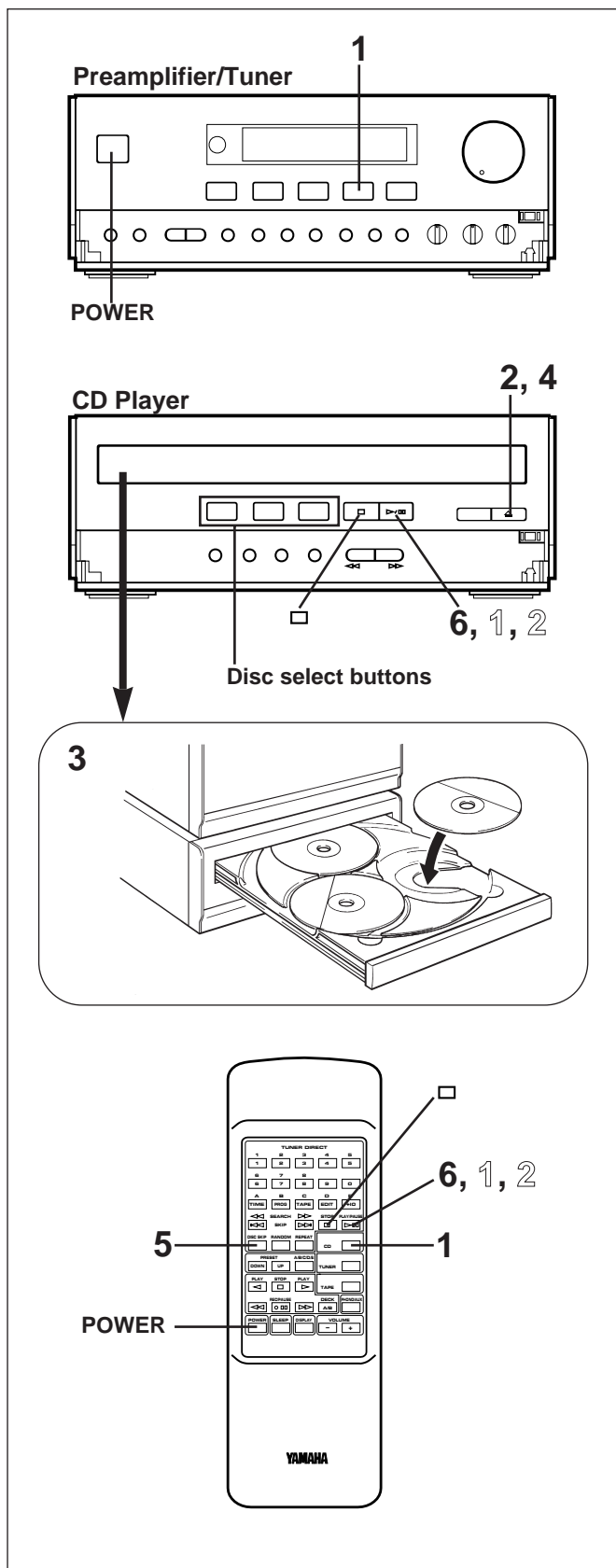

CD playback

- 1** Press the CD input selector button.
- 2** Press the OPEN/CLOSE button to open the disc table.
- 3** Place discs on the trays, label side up.
 - * Up to three discs can be loaded on the trays.
 - * 8 cm (3") discs may be played without an adaptor.
- 4** Press the OPEN/CLOSE button to close the disc table.
 - * The total number of tracks and the total playing time of the disc being selected will be displayed for several seconds.
 - * The music calendar will be displayed only for the number of tracks on the disc being selected.
 - * If the compact disc contains more than 21 tracks, the "OVER" indicator will light up on the music calendar.

The disc on the tray located on top of this indicator is now being selected.

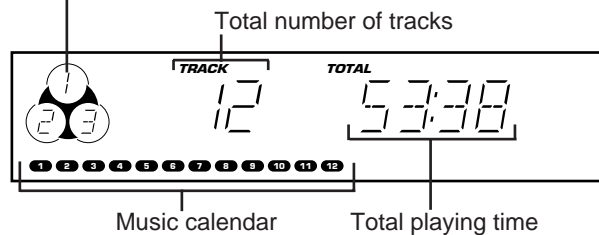

- 5** If necessary, select another disc by pressing the DISC SKIP button on the remote control transmitter once or more (so that the corresponding disc tray number is located on top of the disc indicator).
- 6** Press the play/pause button to start playback from track 1.
 - * The "▷" indicator will appear and playback will begin.
 - As the playback of each track on the music calendar is finished, that track number will go out.

For easier operation

Pressing the disc select button (1, 2 or 3) will select the disc directly, and playback will begin from track 1 automatically.

To interrupt playback

- 1** Press the play/pause button.
 - * The "▷" indicator will flash.
- 2** Press the play/pause button to resume playback from the same point.

To stop playback

Press the stop □ button.

To switch the unit off after use

Turn the unit off by pressing the POWER switch. (The indicators will go off except for the current time display.)

Direct operation

Even when an input source other than CD player is selected, pressing the play/pause button, a disc select button, a track number input button or the RANDOM play button, or pressing the front edge of the disc table gently will start playback directly. In this case, if the tape deck is playing back a tape, it will be stopped automatically.

* These ways of playback can also be used to close the disc table. If the table is closed in these ways, playback will begin automatically, however, the display will not show the total number of tracks and the total playing time of the disc to be played.

PLAYXCHANGE

During playback, you can open the disc table by pressing the PLAYXCHANGE button without interrupting disc playback. However, in this case, pressing the DISC SKIP button on the remote control transmitter has no effect.

Precautions

- If TV or radio interference occurs during CD player operation, move the unit away from the TV or radio.
- Subjecting the unit to shock or vibration can cause mistracking.
- Playing some compact discs at high volume can cause mistracking. In this case, listen at lower volume.
- Do not push the disc table while it is moving.
- If the power fails while the table is open, wait until the power supply returns or gently push the table manually to close it.
- The temperature range for playing compact discs is recommended to be 5°C (41°F) – 35°C (95°F).

Direct-selection play

By using the track number input buttons on the remote control transmitter, any track you wish to listen to can be played directly.

Use the track number input buttons to select the desired track number. Play will begin automatically.

A. For example, to choose selection 5
Press the "5" button.

B. For example, to choose selection 12
(1) Press the "+10" button.
(2) Within 3 seconds, press "2" button.

C. For example, to choose selection 20
(1) Press the "+10" button.
(2) Within 3 seconds, press the "+10" button again.
(3) Within 3 seconds, press the "0" button.

Note

A track number higher than the number of tracks on the disc cannot be selected. Also, if a higher track number is selected while the disc table is open, play will begin from the last track on the disc when the disc table is closed.

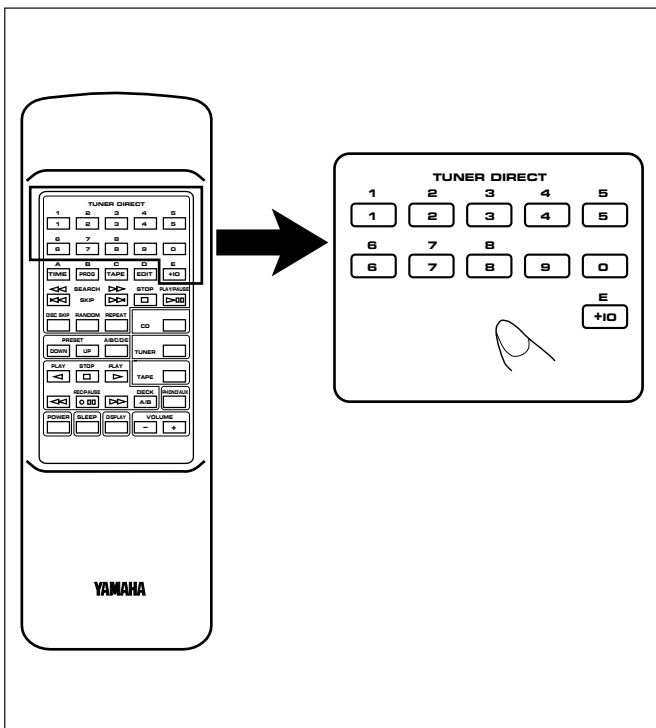

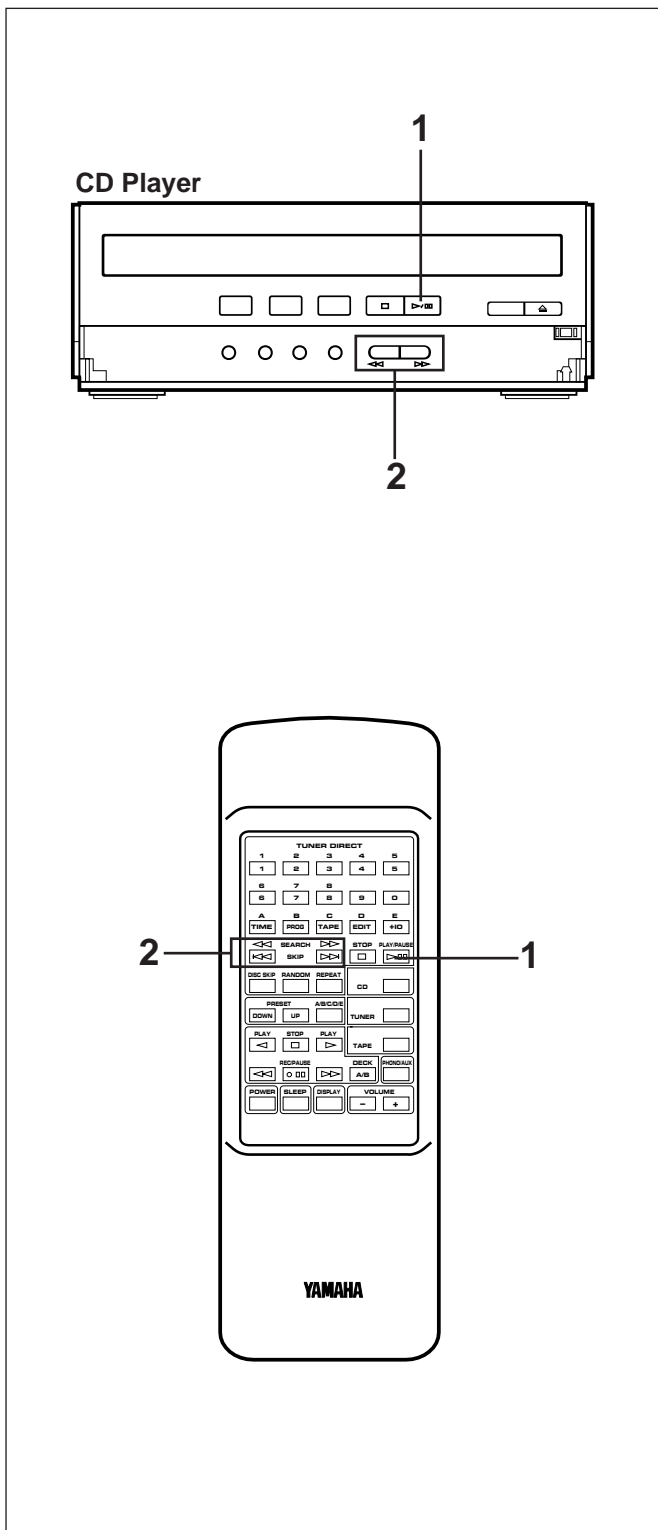

“Skip search” and “Manual search” are performed using the same buttons.

Skip search

The beginning of any track can be found automatically.

- 1 Select a disc and begin playback.
- 2 Press the $\triangleright\triangleright$ button to advance or $\triangleleft\triangleleft$ button to reverse through the disc. Press once for each track to be advanced or reversed.
 - Press $\triangleright\triangleright$ once to advance to the track following the one now playing back.
 - Press $\triangleleft\triangleleft$ once to return to the start of the track now playing back.
 - Press $\triangleleft\triangleleft$ twice to return to the track before the track now playing back.

Notes

- This function can also be performed while the unit is stopped. Press the play/pause button when your desired track number appears in the track number display. Playback will begin from the beginning of the track.
- This function will be performed forward or backward from any point on the disc. However, it will not move forward during playback of the final track.

Manual search

- 1 Begin playback.
- 2 Press and hold the $\triangleright\triangleright$ button to advance play rapidly, and the $\triangleleft\triangleleft$ button to reverse play rapidly.
 - * The sound can be heard (although slightly garbled) during manual search in either direction. This is convenient for reviewing the contents quickly.

Note

Manual search can also be performed while playback is paused, though no sound will be heard.

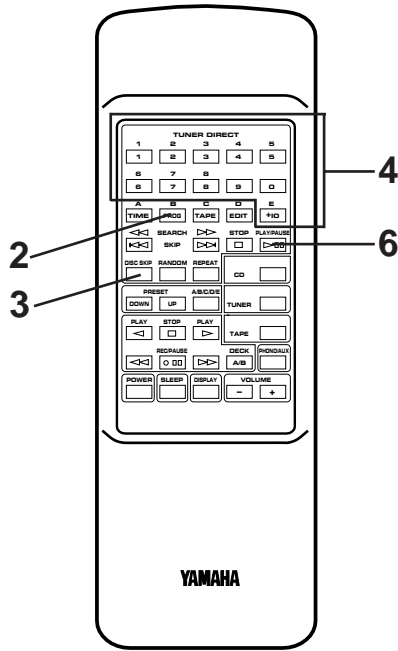
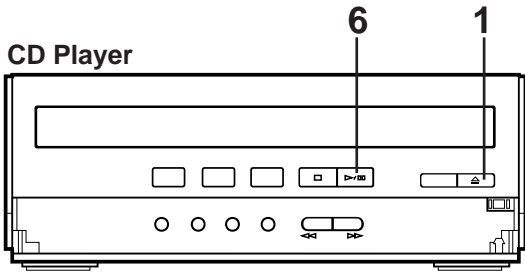

Display information during programming

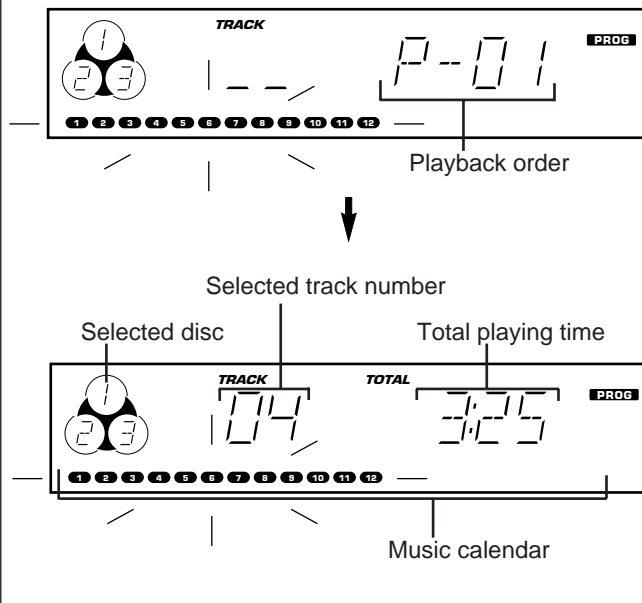

Program play

You can program up to 20 tracks in any desired order.

- 1** Load discs and close the disc table.
- 2** When in the stop mode, press the PROGRAM button to prepare for programming.
 - * "PROG" and "P-01" illuminate on the display, and all track numbers on the selected disc begin flashing.
- 3** If necessary, select a desired disc by pressing the DISC SKIP button.
- 4** Use the track number input buttons to select the desired track number.
 - * The selected track number and the total play time of the programmed tracks will illuminate on the display, and soon it is replaced by the display of the next playback order. Programmed track numbers on the selected disc will stop flashing and illuminate on the music calendar.
 - * Pressing the TIME button displays the total play time of the programmed tracks for about 1 second, and then it is replaced by the display of the next playback order.
- * **For example, to choose selection 12**
 - (1) Press the "+10" button.
 - (2) Within 3 seconds, press the "2" button.
- 5** Repeat steps 3 and 4 for any other track. Up to 20 tracks can be programmed.
- 6** Press the play/pause button to start playback of programmed tracks.

Notes

- It is also possible to program a sequence of tracks while looking at the list of tracks on the surface of the disc before closing the disc table.
- During playback or pause, programming is not possible.
- If the total time of the programmed tracks reaches 100 minutes or more, only the last two-digits will be displayed for the three-digit number.
- The total time of the programmed tracks will not be displayed, if a track number higher than 19 is programmed.
- Skip search can be performed during playing back, but only within the range of the programmed tracks.
- Manual search can be performed during playing back to search through all tracks, including unprogrammed tracks.
- If programs are made selecting tracks from more than one disc, pressing the PLAYXCHANGE button is useless during program play.

COMPACT DISC PLAYER OPERATION

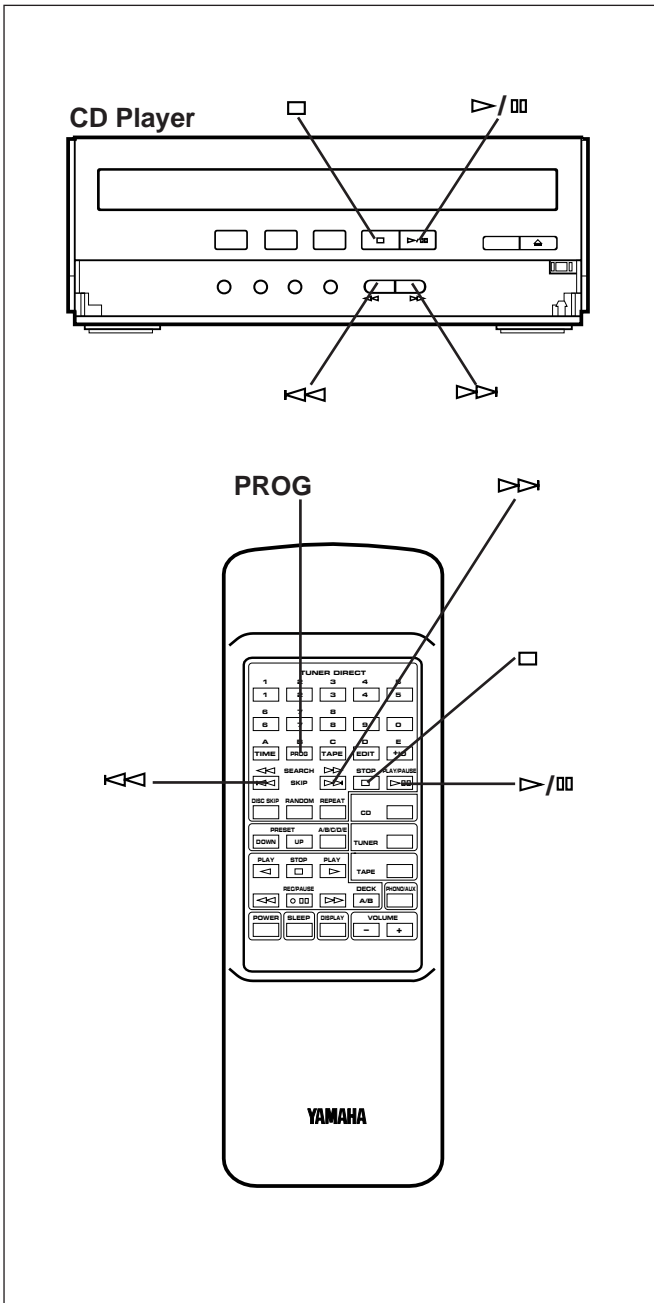

To stop program play

- Press the stop □ button. The first track number programmed will be displayed.
- To resume playback, press the play/pause ▷/⏸ button. Playback will begin from the beginning of the program.

To cancel a programmed sequence

There are several methods as described below.

- Press the stop □ button while the unit is stopped.
- Open the disc table
- Switch off the power.

To check program data

1. If during playing back, press the stop □ button.
2. Press the PROGRAM button.
3. Each time the SKIP ▷▷ button is pressed, the track numbers and sequential order of the programmed tracks can be checked one after another. The display of the track number can be returned (sequentially in reverse order) by pressing the SKIP ◀◀ button.

To correct program data

1. Follow the procedure described in "To check program data".
2. Display the track number to be corrected by pressing the SKIP button.
3. Press a track number input button to select a track to replace the one displayed. The previously programmed track will be cleared from the memory and the new one will be programmed.
4. After the correction has been completed, press the PROGRAM button or play/pause ▷/⏸ button once again.

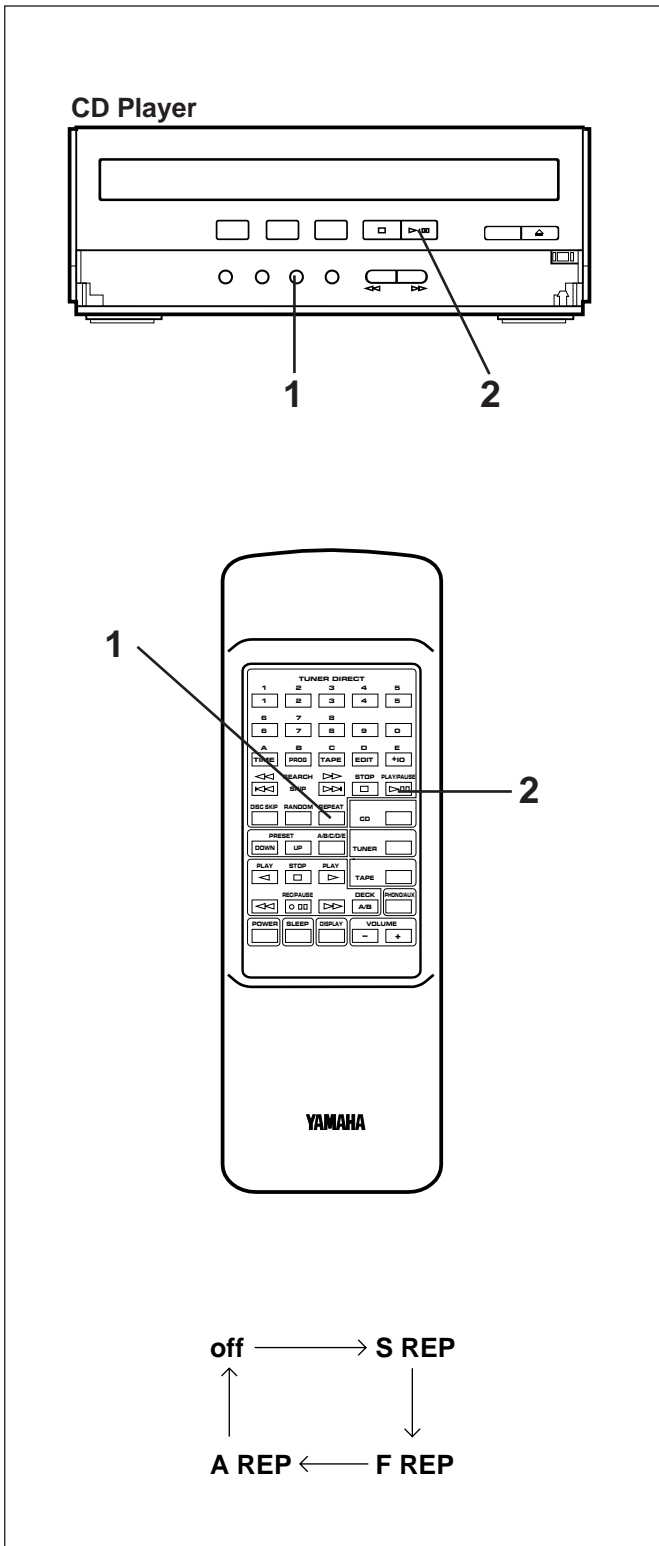

Repeat play

All discs, an entire disc, a single track or a programmed sequence can be continuously repeated.

- 1 While watching the display, press the REPEAT button once or more to select a desired repeat play mode (S REP, F REP or A REP).
- 2 Press the play/pause button.

Repeat play modes

SINGLE REPEAT (S REP)

A single track is played back repeatedly.

- * This is also available in the program play mode and the random play mode. (If the repeat play mode is switched off, the program play mode or the random play mode will be resumed.)

FULL REPEAT (F REP)

A designated disc is played back repeatedly.

- * In the random play mode, the selected disc is repeatedly played back, but the order of tracks is different every time.

ALL REPEAT (A REP)

All discs in the disc table are played back repeatedly.

- * In the program play mode, a sequence of programmed tracks is played back repeatedly.
- * In the random play mode, the random play is performed among all discs and repeated with a different order of tracks every time.

To cancel the repeat play

Press the REPEAT button once or more so that the (S, F, A) REP indicator goes out.

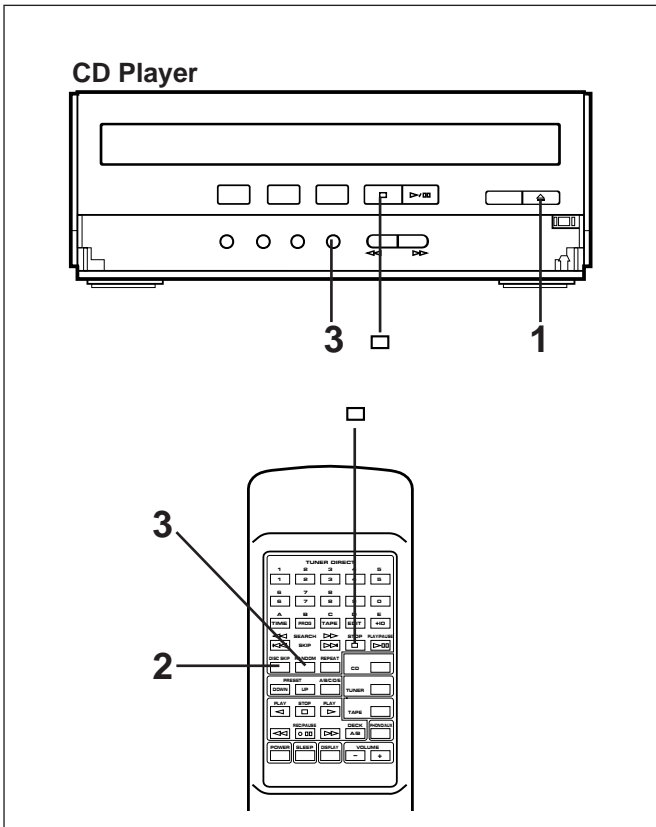

Random play

The tracks on the selected disc can be played back in a random order.

- 1 Load discs and close the disc table.
- 2 Select a desired disc by pressing the DISC SKIP button.
- 3 Press the RANDOM button to begin random play.
 - * The "RANDOM" indicator will light up.

To cancel the random play

Press the stop  button. The "RANDOM" indicator goes out.

Note

This feature will not function during programming, or during program play.

Switching the time display

Each time the TIME button is pressed, the display will change as described below.

[Example]

When the second track is being played back (Refer to the illustration on the left.)

- ① The elapsed play time for the track now playing back will be displayed.
 - * 8 seconds have passed since the beginning of the second track.
- ② The remaining play time for the current track will be displayed.
 - * 2 minutes and 58 seconds remain till the end of the second track.
- ③ The total play time of the disc will be displayed. (If the unit is in the program play mode, the total play time of the programmed tracks will be displayed.)
- ④ The total remaining play time from the point being played at that time will be displayed.
 - * 41 minutes remain till the end of the disc.

Notes

- During random play, the total remaining play time on the disc will not be displayed.
- The total remaining play time will not be displayed for track number 20 or higher.

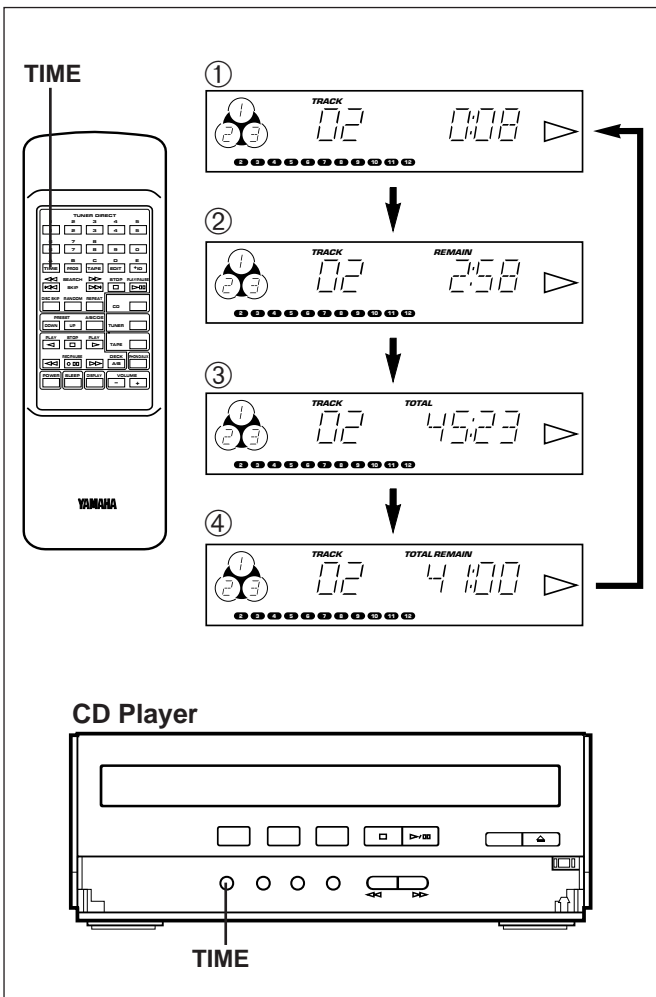

TUNING OPERATION

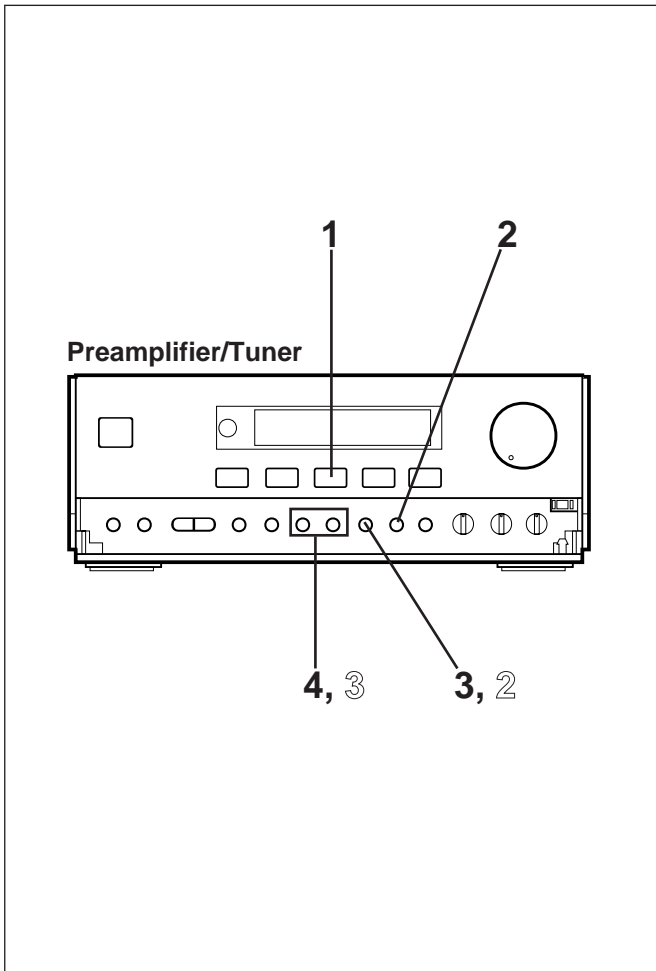

"AM" is for U.S.A., Canada and General models.
"MW/LW" is for Europe model.

Normally, if station signals are strong and there is no interference, quick automatic-search tuning (Automatic tuning) is possible. However, if signals of the station you want to select are weak, you must tune to it manually (Manual tuning).

Automatic tuning

- 1 Press the TUNER input selector button.
 - 2 Select the reception band [FM or AM (MW or LW)] by pressing the BAND button while watching the display.
 - 3 Press the AUTO/MAN'L button so that "AUTO TUNING" appears on the display.
(In this mode, stations are received in stereo or monaural automatically.)
 - 4 Press the TUNING UP button to tune to a higher frequency, or press the TUNING DOWN button to tune to a lower frequency.
 - 5 If the station where tuning search stopped is not the desired one, follow step 4 again.
- * If the tuning search does not stop at the desired station, change to the Manual tuning method as described below.
 - * STEREO indicator will illuminate when an FM stereo broadcast with sufficient signal strength is received.

Manual tuning

- 1 Follow steps 1 and 2 of the Automatic tuning method.
- 2 Press the AUTO/MAN'L button so that "AUTO TUNING" disappears from the display.
(In this mode, stations are received in monaural.)
- 3 Press and hold the TUNING UP button to tune to a higher frequency, or press and hold the TUNING DOWN button to tune to a lower frequency.
Release it just before reaching the desired frequency, and then press it repeatedly until the desired frequency appears.

Note

If you tune to an FM station manually, it is received in monaural automatically to increase the signal quality.

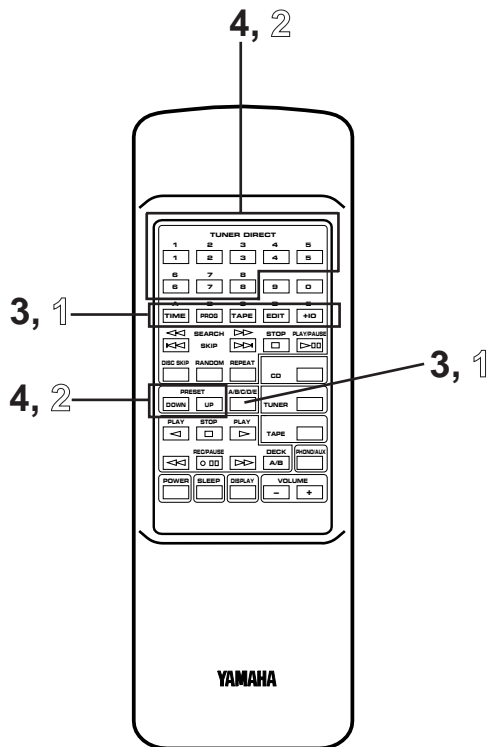
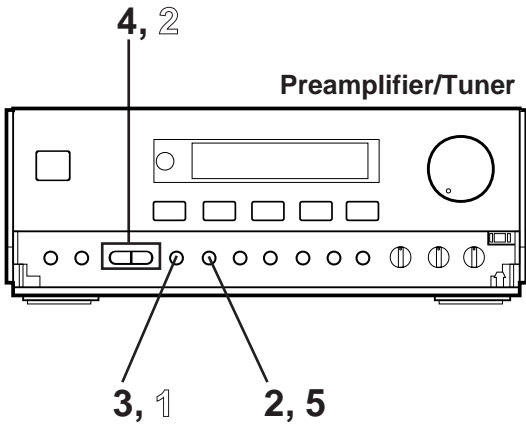

Preset tuning

This unit can store station frequencies selected by tuning operation. With this function, you can select any desired station by only calling the corresponding preset station number. Up to 40 stations (8 stations x 5 areas) can be stored.

To store stations

(Example: To store a station to A1)

- 1 Tune to a desired station.
(Refer to the previous page for tuning procedure.)
- 2 Press the MEMORY button.
* The MEMORY indicator will flash for about 5 seconds.
- 3 Select a desired area (A – E) by pressing the A/B/C/D/E button while watching the display, before the MEMORY indicator goes out.
(In this case, select area A)
- 4 Select a preset station number by pressing the TUNER PRESET DOWN or UP button repeatedly before the MEMORY indicator goes out.
(In this case, select "1".)
- 5 Within about 5 seconds, press the MEMORY button again.

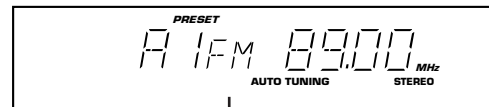

Shows the displayed station has been programmed to A1.

- * In the same way, program other stations to A2, A3 ... A8.
- * You can program more stations to the preset station numbers on other areas in the same way by selecting other areas in step 2.

To recall a preset station

- 1 Select the area of preset station numbers by pressing the A/B/C/D/E button.
- 2 Select the desired preset station number by pressing the TUNER PRESET DOWN or UP button repeatedly.

Notes

- A new setting can be programmed in place of the former one.
- For presets the setting of the AUTO/MAN'L button is stored along with the station frequency.

For easier operation

By using the preset station number buttons and the A,B,C,D,E selector buttons on the remote control transmitter, a preset station number and an area can be selected directly.

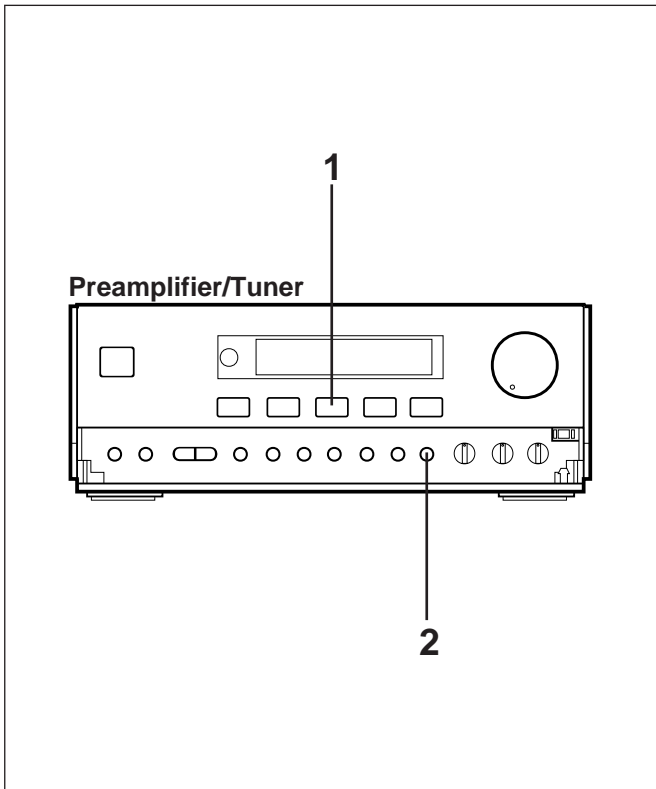

Automatic preset tuning

You can also make use of an automatic preset tuning function. By this function, this unit performs automatic tuning and stores stations with strong signals sequentially. Up to 40 stations are stored automatically in the same way as in the manual preset tuning method on the previous page.

- 1** Press the TUNER input selector button.
- 2** Press and hold the AUTO MEMORY button for about 2 seconds.
 - * The MEMORY and AUTO TUNING indicators will flash.

This unit performs automatic tuning and received stations are programmed to A1, A2 ... A8 sequentially.

After the automatic preset tuning is completed

The display shows the frequencies of the first preset station (stored to A1). Check the contents and the number of preset stations by following the procedure of the section "To recall a preset station" on the previous page.

To recall a preset station

Simply follow the procedure of the section "To recall a preset station" on the previous page.

Notes

- The automatic preset tuning search will be performed through all frequencies until 40 stations are stored. If the number of received stations is less than 40, the search will stop after searching through all frequencies.
- With this function, only stations with sufficient signal strength are stored automatically. If the station you want to program is weak in signal strength, tune to it in monaural manually and program it by following the procedure of the section "To store stations" on the previous page.
- You can replace a preset station by another FM or AM (MW or LW) station manually by simply following the procedure of the section "To store stations" on the previous page.

Fundamental rules of internal automatic preset tuning operation

Basically, FM stations are programmed onto area A, B and C, and AM stations are programmed onto area D and E (MW stations are onto D and LW stations are onto E) in that order automatically.

* If, for example, the number of received FM stations is not enough to fill up three areas (A, B and C), AM (MW or LW) stations are programmed closely from the preceding empty areas. In such a case, AM (MW) stations are programmed from area B or C (and LW stations are from area C or D.)

* Moreover, one area is programmed with stations of the same band only. If, for example, the last FM station is programmed to B4, B5–B8 will be programmed with no station, and AM (MW) stations are programmed from area C.

Memory back-up

The memory back-up circuit prevents the programmed data from being lost even if the AC supply lead is disconnected from the AC outlet or the power is cut due to temporary power failure. If, however, the power is cut for more than one week, the memory may be erased. If so, it can be re-programmed by simply following the Preset tuning steps.

TAPE DECK OPERATION

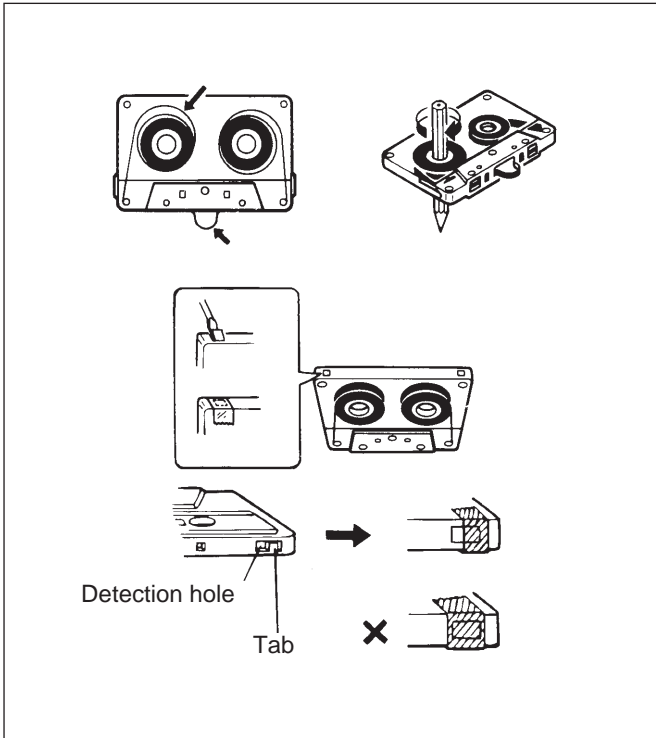

General information

- Do not use C-120 tapes, tapes with internal reels or poor-quality tapes, since they can cause malfunctions.
- Before loading a tape into the cassette compartment, tighten the slack tape with a pen or pencil.
- Tapes have removable tabs which prevent accidental recording or erasing from taking place. Removing the tab on the top left protects the side facing you from erasure. Cover the tab holes with adhesive tape to erase or record again.
- This deck is a Single Cassette Deck with Automatic Reverse Function.
- This deck features an auto tape selector. Just load the tape, and the tape formula being used will be sensed automatically.
- This unit can play back metal tapes as well as normal or chrome tapes, and recording can also be done on metal tapes.
- When covering erasure prevention tab holes, do not cover the chrome and metal detection holes. Otherwise, the deck will treat tape as normal tape.
- Do not press the OPEN/CLOSE button during playback or recording.

Tape playback

- 1 Press the TAPE input selector button.
- 2 Open the cassette compartment by pressing the OPEN/CLOSE button.
- 3 Load the tape into the cassette compartment.
- 4 Set the Dolby NR switch to B or C if the tape has been recorded with Dolby noise reduction, and to OFF if Dolby NR was not used.
* For selection of the Dolby B or C position, refer to the "Dolby B and C Type Noise Reduction" on page 27.
- 5 Set the reverse mode switch as desired.

The reverse mode switch can be operated before or during playback, and changes tape playback as follows:

	Side A only	Side A → Side B	Side A → Side B Continuous play (8 times)
	Side B only	Side B only	Side B → Side A Continuous play (8 times)

- 6 Press the play button to listen to side A, or the play button for side B.

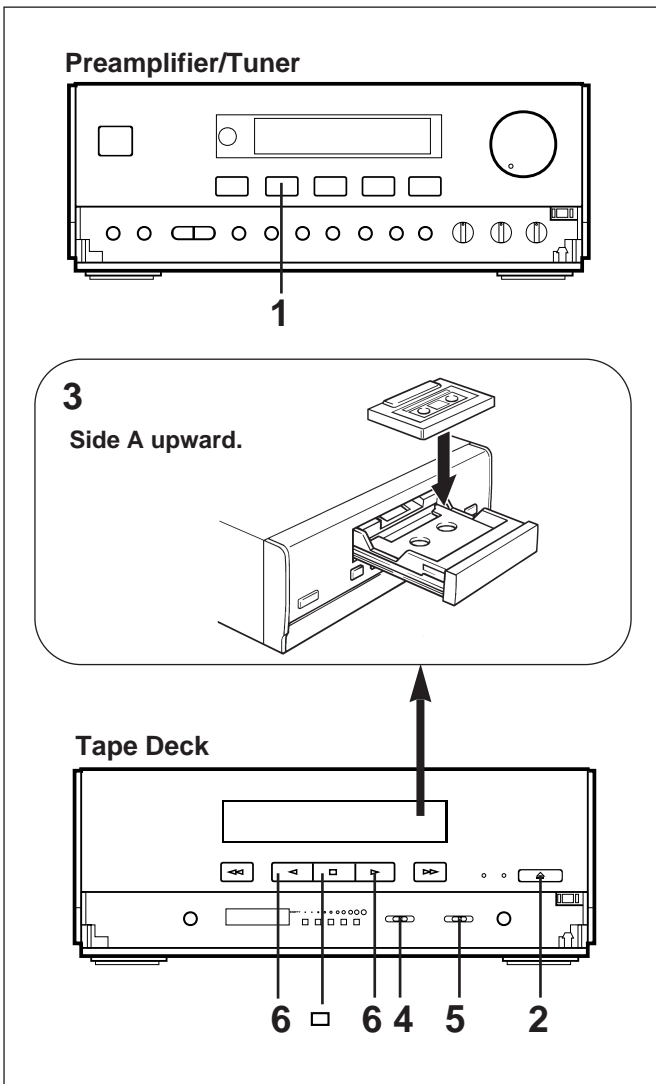

To stop playback

Press the stop button.

Note

When removing the tape, press the stop button, and then open the cassette compartment.

Direct operation

Even if an input source other than tape deck is selected, pressing the play button (or the fast wind button) will start playback (or fast winding) directly.

Tape Counter (LINEAR COUNTER) and RESET button

This unit is equipped with a tape counter which is useful for searching and locating a desired point on tape. The tape counter is displayed by minutes and seconds, though the displayed time is not so close to the actual elapsed time. (It will be close to the actual elapsed time by using a tape with the length of 60 minutes or 90 minutes.)

Pressing the RESET button on the left side of the tape counter resets the tape counter to "0:00".

REMAIN indicators

The remaining amount of the tape for the side now being played back is shown by the illumination of these indicators. According as the tape is played back, the indicators will go out one by one.

When the tape playback nears the end of the side, the indicator at the left end flashes rapidly. However, when using a tape with large hubs, the tape may stop before the indicator flashes. This is because the error between the displayed time and the actual elapsed time becomes large when using these tapes.

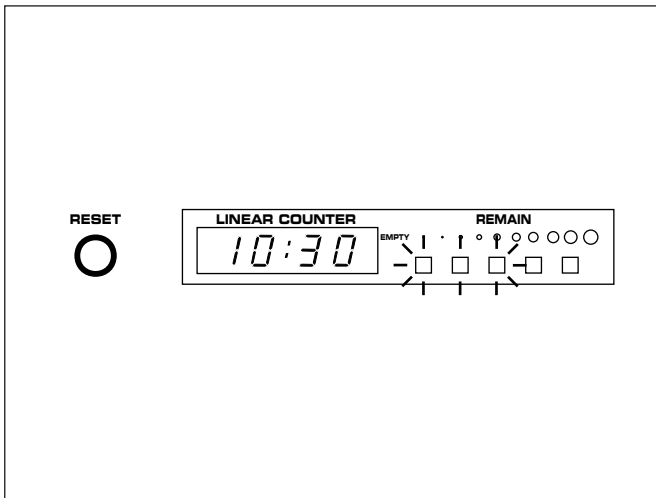

Dolby B and C Type Noise Reduction

With cassette tapes, the most noticeable form of noise is high frequency hiss. To reduce this hiss noise, this unit has been equipped with a newly developed Dolby C noise reduction system in addition to its conventional Dolby B NR. Either type of noise reduction may be selected with the switch provided. Dolby B NR has a noise reduction effect of about 10 dB in the high frequency range. The corresponding figure with Dolby C NR is about 20 dB, but this is over the entire range where the human ear is most sensitive to noise (2 kHz to 8 kHz). Also, Dolby C NR has the same noise reduction effect at both high and low signal levels. In addition, Dolby C NR improves the tape's MOL (Maximum Output Level). Dolby noise reduction is a 2 part process that acts both on recording and playback; be sure that the noise reduction button is set to the same position on record and play.

* Noise in the source material cannot be reduced with the Dolby NR system.

Dolby HX PRO Dynamic Bias Servo System

This unit incorporates the Dolby HX Pro system which automatically controls the effective bias to reduce distortion and noise, improving high frequency response during recording. Tapes recorded with this system retain the same high quality even when played back on any other tape deck.

DOLBY B-C NR HX PRO



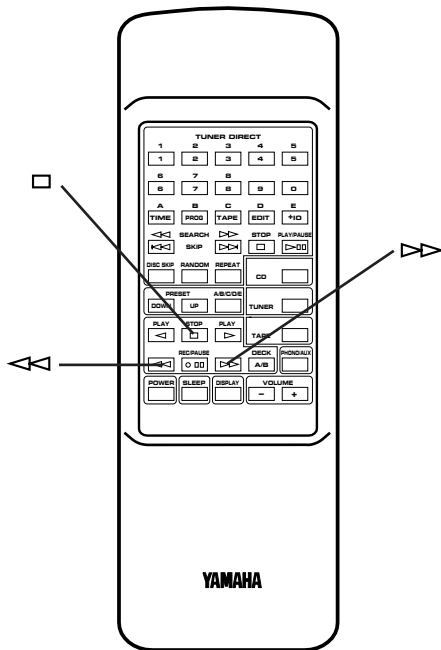
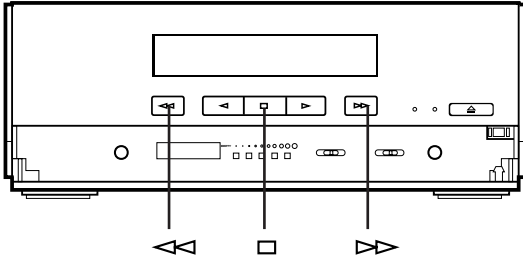

Dolby noise reduction and HX Pro headroom extension manufactured under license from Dolby Laboratories Licensing Corporation, HX Pro originated by Bang & Olufsen.

"DOLBY", the double-D symbol  and "HX PRO" are trademarks of Dolby Laboratories Licensing Corporation.

Tape Deck



Winding the tape



- 1 If during playback, first press the stop  button.
- 2 Next press the fast wind  or fast wind  button to wind the tape.
- 3 Press the stop  button to stop.

* While winding the tape, the corresponding play direction indicator flashes rapidly.

Note

When the tape is wound to the end, this unit will then function as described below, according to the setting of the reverse mode switch.

 : The tape stops at the end.

 : If the winding direction is , when the tape reaches the end, playback automatically starts from the reverse side.



If the winding direction is , the tape stops at the end.



 : When the tape reaches the end, playback automatically starts from the reverse side.

Searching for the beginning of a desired selection



Carry out the following operation during playback to find the beginning of a desired selection on the tape.



To listen to the same selection

Press the  button if the direction of the current playback is .

Press the  button if the direction of the current playback is .

To listen to the next selection

Press the  button if the direction of the current playback is .

Press the  button if the direction of the current playback is .

* While searching, the corresponding play direction indicator flashes slowly.

Notes

- This function may not work for tapes with
 - * Material with long pauses or quiet passages.
 - * Low recording levels or excessive noise.
 - * Pauses of less than 4 seconds between selections.
- If searching is carried out at the first or the last part of a selection, the searching may not function correctly.

RECORDING COMPACT DISCS

Preamplifier/Tuner

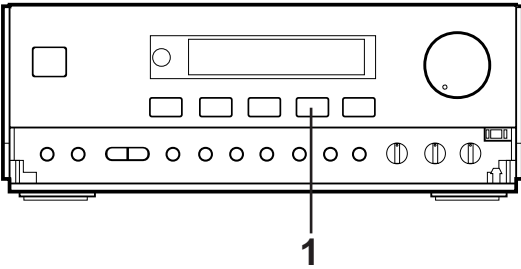

CD Player

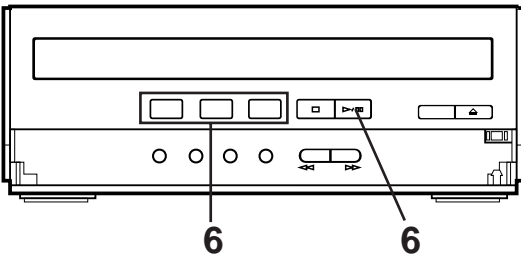

Tape Deck

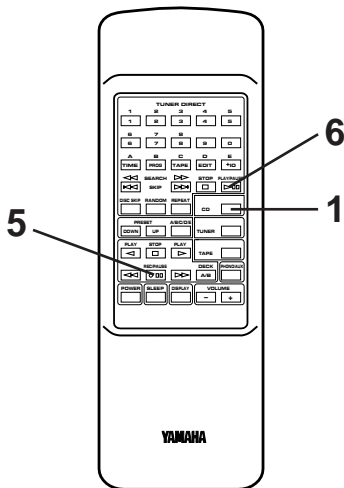
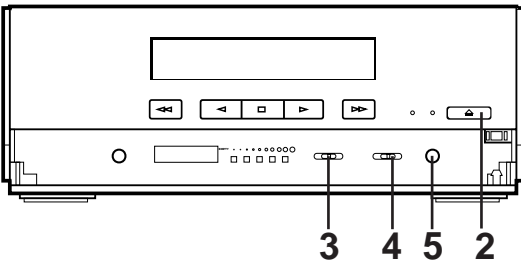

- When recording important selections, be sure to make a preliminary test to ensure that the desired source material is being properly recorded with good sound quality.
- The automatic recording level control circuit automatically controls the level of the input signal used for recording.
- Adjusting the VOLUME, BALANCE, TREBLE and BASS controls have no effect on the recorded sound.

CD synchronized recording

- 1 Press the CD input selector button and load the disc to be recorded.
- 2 Load a tape into the cassette compartment.
 - * Wind past the beginning part of the tape on which recording can not be performed.
- 3 When recording with the Dolby NR system, set the Dolby NR switch to B or C; if not, set it to OFF.
 - * For selection of the Dolby B or C position, refer to the "Dolby B and C Type Noise Reduction" on page 27.
- 4 Set the reverse mode switch as desired.

When the tape is set so that side A faces you, recording will be done as follows automatically according to the selected reverse mode.



	Side A only	Side A → Side B	Side A → Side B
	Side B only	Side B only	Side B only

- 5 Press the REC/PAUSE button.
 - * The corresponding indicator will light up and the play direction indicators flash.
- 6 Start CD playback by pressing the corresponding disc select button, or by pressing the play/pause button if the disc is already selected.
 - * Before CD playback begins, recording automatically begins on the side of the tape now selected.

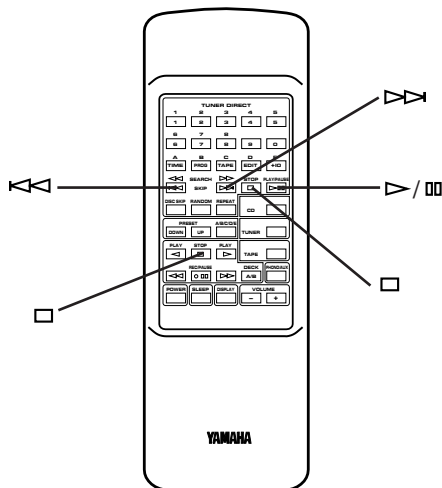
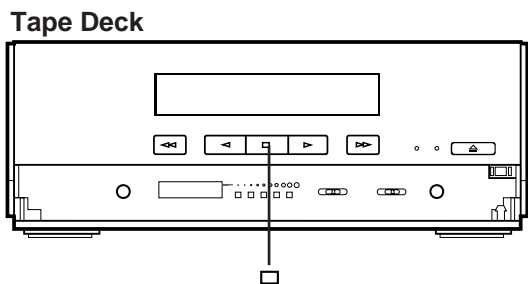
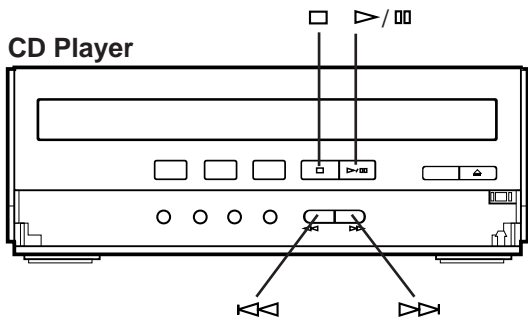
RECORDING COMPACT DISCS



To stop recording temporarily

- 1 Press the stop  button of the CD player.
- 2 Choose the selection to be recorded next by using the SKIP  or  button, and then press the play button of the CD player to resume recording (or simply press the track number input button on the remote control transmitter).

To stop recording

Press the stop  button of the tape deck.
(At this time, CD playback does not stop.)

Recording programmed tracks

Programmed tracks from one or more discs can also be recorded in the same way.

- 1 Program desired tracks from one or more discs. (Refer to page 19 for the programming procedure.)
- 2 Follow steps 2–5 on the previous page.
- 3 Press the play/pause  button of the CD player.

Notes

- During CD Synchronized Recording, when more than 4 seconds elapse between tracks, the tape will stop automatically and resume recording when the beginning of the next track is found.
- The CD Synchronized Recording will function even when the CD player is turned into random play mode.

Preamplifier/Tuner

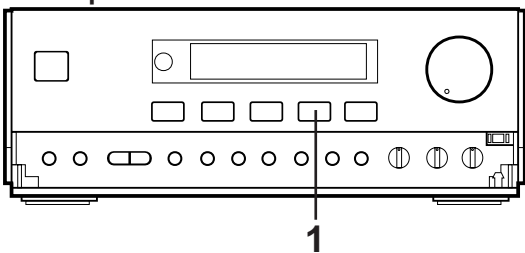

CD Player

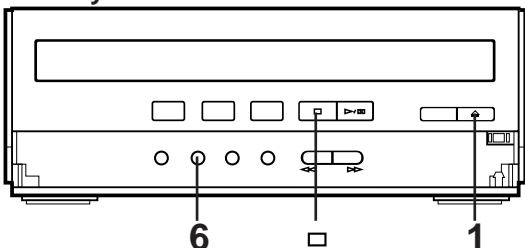

Tape Deck

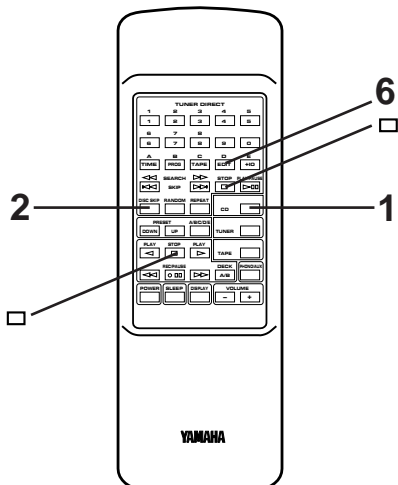
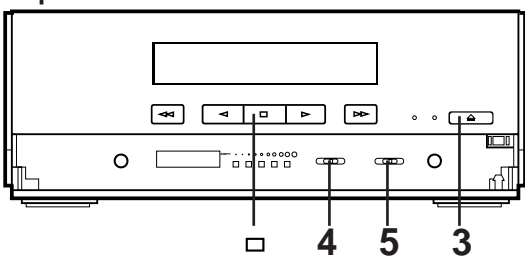

Recording CD(s) on both sides of a tape automatically

- 1 Press the CD input selector button and load the disc to be recorded.
- 2 Select the disc by pressing the DISC SKIP button.
- 3 Load a tape into the cassette compartment.
- 4 When recording with the Dolby NR system, set the Dolby NR switch to B or C; if not, set it to OFF.
 - * For selection of the Dolby B or C position, refer to the "Dolby B and C Type Noise Reduction" on page 27.
- 5 Set the reverse mode switch to or .
- 6 Press the EDIT button. ("EDIT" appears on the display.) CD playback and recording starts. Recording is carried out on side A and B of the tape continuously.
 - * If the tape has not rewound to the end, it is rewound to the end rapidly before recording starts. Recording starts from the first part of the tape on which recording can be done.
 - * "A " (or " B") on the display shows the side of the tape on which recording is being carried out.
 - * When the recording on side A finishes while a track is being played back, the sound is automatically faded out, and then the recording stops. The recording on side B starts from the beginning of the same track.

Notes

- If the tape's total possible recording time is longer than the total playing time of the selected disc, tracks on another disc are recorded automatically. In this case, as many as three discs can be recorded continuously.
- During recording, the PLAYXCHANGE button on the CD player is disabled.
- The CD player's repeat play mode (except for the "A REP" mode) will be canceled during this recording mode. If the "A REP" repeat play mode is selected, it will not be canceled, but it will not function until the recording is finished.

Recording programmed tracks

Programmed tracks from one or more discs can also be recorded in the same way.

- 1 Program desired tracks from one or more discs. (Refer to page 19 for the programming procedure.)
- 2 Follow steps 3–6 described above.

To cancel this function

Before recording, press the stop button of the CD player or the tape deck.

To stop recording

Press the stop button of the tape deck. (At this time, CD playback automatically stops.)

Preamplifier/Tuner

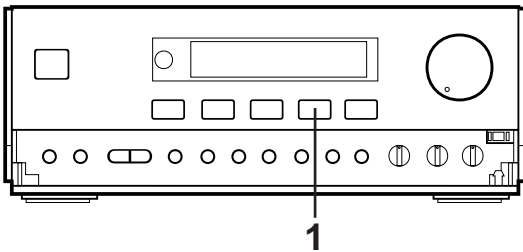

CD Player

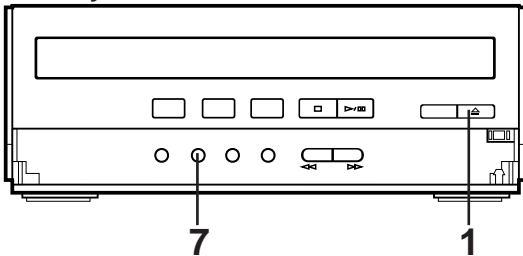

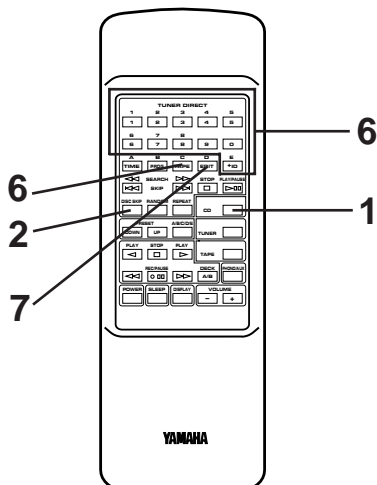
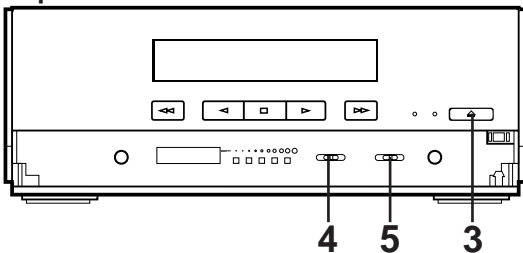

Tape Deck



Automatic tape-editing

This convenient feature can be used to program tracks on a disc (or discs) for recording to tape. By only memorizing the tape's total possible recording time, the unit will automatically program tracks or help you to program tracks so they will fit onto the tape with the least amount of unrecorded space remaining at each end of the tape.

To record a disc with the order of tracks unchanged

- 1 Press the CD input selector button and load the disc to be recorded.
- 2 Select the disc by pressing the DISC SKIP button.
- 3 Load a tape into the cassette compartment.
- 4 When recording with the Dolby NR system, set the Dolby NR switch to B or C; if not, set it to OFF.
* For selection of the Dolby B or C position, refer to the "Dolby B and C Type Noise Reduction" on page 27.
- 5 Set the reverse mode switch to  or .
- 6 Press the TAPE button to select the length of the tape to be used. Whenever pressed, C-46, C-54, C-60 and C-90 appear on the display in turn, and next it returns to the normal display mode.

off → C-46 → C-54 → C-60 → C-90
↑

When using tapes other than C-46, C-54, C-60 or C-90

When C-46, C-54, C-60 or C-90 is appearing on the display, input the tape length by using the track number input buttons on the remote control transmitter (Examples)

C-62: Press "6" and then "2".

C-30: Press "3" and then "0", or press "+10" three times and then "0".

- 7 Press the EDIT button. ("EDIT" appears on the display.) The following internal operations are carried out before recording is automatically started.

- 1) Tracks on the disc are automatically divided between side A and side B. You can check the process by watching the display.
- 2) The end part of the tape on which recording cannot be done is wound.
- 3) This unit starts searching a peak level through all tracks to be recorded. (While searching, "LEVEL" flashes on the display.) When searching is finished, this unit adjusts the recording level properly on the basis of this data.
- 4) CD playback and recording starts. Recording is carried out on both side A and B of the tape.

RECORDING COMPACT DISCS

CD player

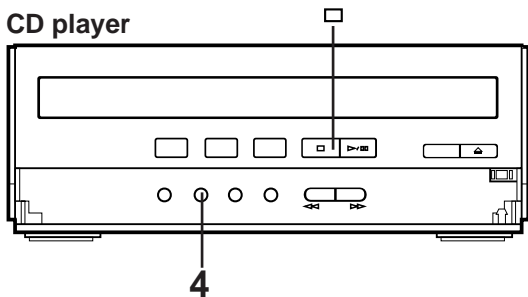

Tape Deck

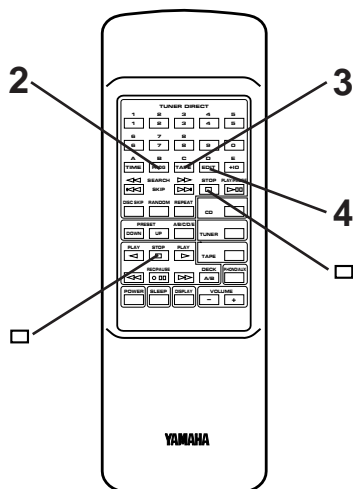
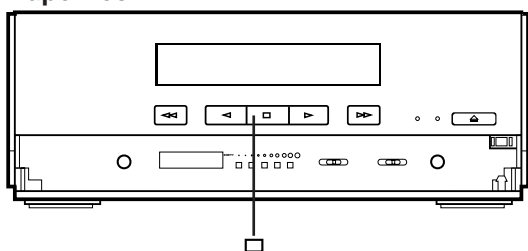

Notes

- If the tape's total possible recording time is longer than the total playing time of the selected disc, tracks on another disc are recorded automatically. In this case, as many as three discs can be recorded continuously.
- If programs are made selecting tracks from more than one disc, during recording, the PLAYXCHANGE button on the CD player is disabled.
- The CD player's repeat play mode (except for the "A REP" mode) will be canceled during this recording mode. If the "A REP" repeat play mode is selected, it will not be canceled, but it will not function until the recording is finished.

To cancel tape-editing function

Before recording, press the stop button of the CD player or the tape deck.

To stop recording

Press the stop button of the tape deck.
(At this time, CD playback automatically stops.)

To make this unit program tracks on a disc automatically so that the least amount of unrecorded space remains on the tape

- 1 Follow steps 1–6 on the previous page.
- 2 Press the PROGRAM button.
- 3 Press the TAPE button.
"AP A> " illuminates during programming for side A, and "AP B> " illuminates during programming for side B.

* After "AP B> " goes out from the display, you can check the programmed contents for side A and B respectively.
To check, cancel or correct program data, refer to page 20.
- 4 Press the EDIT button. ("EDIT" appears on the display.)
The recording is automatically started.

* The unit searches a peak level on each track to adjust the recording level properly. The search is carried out before recording each track. (While searching, "LEVEL" flashes on the display, and recording is paused.)

RECORDING COMPACT DISCS

Preamplifier/Tuner

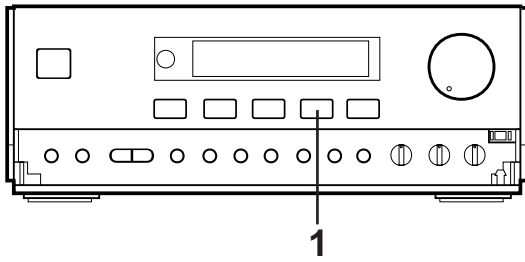

CD Player

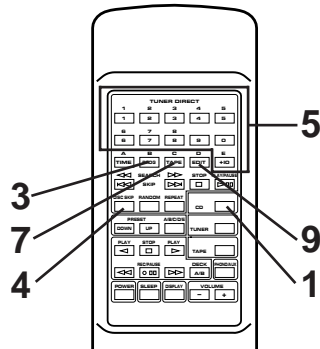
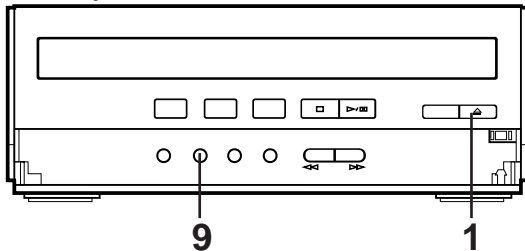

Display information during programming

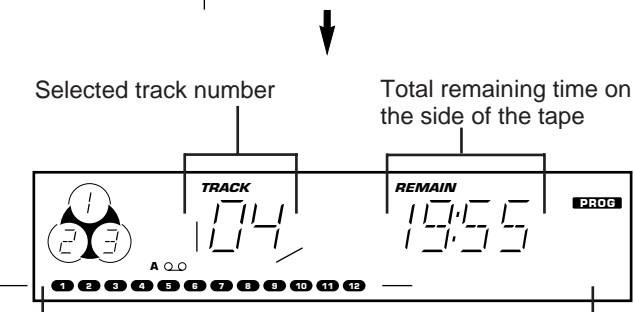
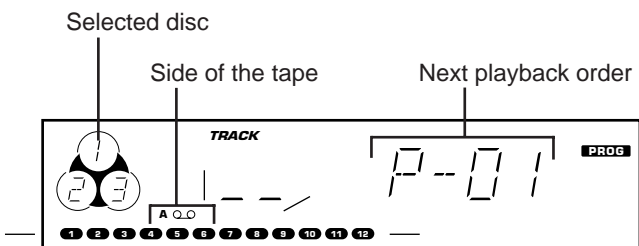

Programmed track numbers illuminate and unprogrammed ones flash.

To record programmed tracks from one or more discs

- 1** Press the CD input select button and load a disc (or discs) on the disc table.
- 2** Follow steps 3–6 on page 32.
- 3** Press the PROGRAM button.
 - * “PROG” and “P-01” illuminate on the display, and all track numbers on the selected disc begin flashing. (If there is a track whose length of time is longer than the selected tape length, its track number will not flash.)
- 4** If necessary, select a desired disc by pressing the DISC SKIP button.
- 5** Use the track number input buttons to select the desired track number.
- 6** Repeat steps 4 and 5 to set more programs for the side A of the tape. You can select the same track again.
 - * Pressing the TIME button displays the total remaining time on the side of the tape for about 1 second, and then it is replaced by the display of the next playback order.
 - * If “ERR” appears on the display, the track number just selected cannot be programmed because there is not enough time remaining on the side A of the tape. However, at this time, if any other track number is flashing continuously on the display, you can program it instead of the unprogrammable one.
- 7** After you finish the programming for the side A, press the TAPE button.
 - * “Pu” appears on the display, then you can begin programming for side B.
- 8** Repeat steps 4 and 5 to set more programs for the side B of the tape. You can select the same track again.
 - * If “ERR” appears on the display, the track number just selected cannot be programmed because there is not enough time remaining on the side B of the tape. However, at this time, if any other track number is flashing continuously on the display, you can program it instead of the unprogrammable one.
- 9** Press the EDIT button. (“EDIT” appears on the display.) The recording is automatically started.
 - * The unit searches a peak level on each track to adjust the recording level properly. The search is carried out before recording each track. (While searching, “LEVEL” flashes on the display, and recording is paused.)

Notes on tape-editing

- To check, cancel or correct program data, refer to page 20.
- The maximum number of tracks that can be programmed is 20.
- This function can be used to program up to track number 20. If the disc has more than 20 tracks, track number 20 and thereafter will not be programmed.

Preamplifier/Tuner

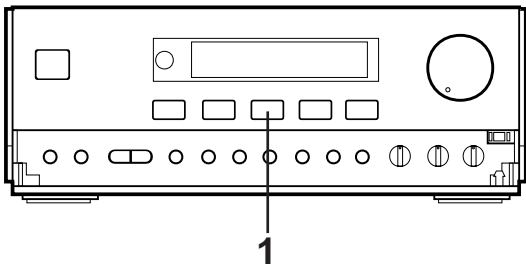

Tape Deck

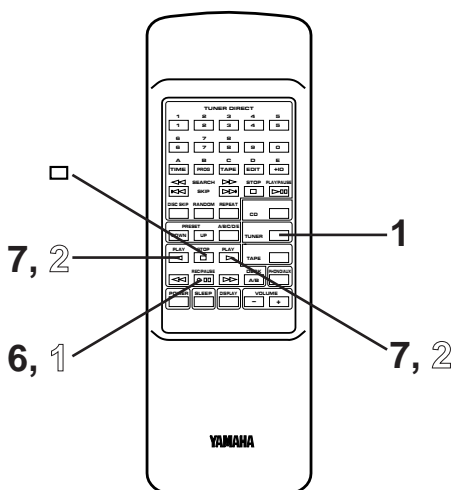
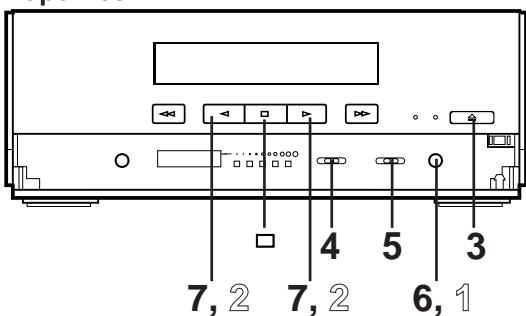

Recording from the built-in tuner

- 1** Press the TUNER input selector button.
- 2** Tune to the desired station. (Refer to the "TUNING OPERATION" on pages 23 and 24.)
- 3** Load a tape into the cassette compartment.
- 4** When recording with the Dolby NR system, set the Dolby NR switch to B or C; if not, set it to OFF.
* For selection of the Dolby B or C position, refer to the "Dolby B and C Type Noise Reduction" on page 27.
- 5** Set the reverse mode switch to to record on only one side, or to (or) for continuous recording on both sides.
- 6** Press the REC/PAUSE button.
* The corresponding indicator lights up and the play direction indicators flash.
- 7** Press the play button to record on side A, or the play button to record on side B.
* For continuous recording on both sides, begin on side A. Recording stops automatically at the end of side B.

To stop recording temporarily

- 1** Press the REC/PAUSE button.
- 2** To resume recording, press the play button whose indicator is flashing.

To stop recording

Press the stop button.



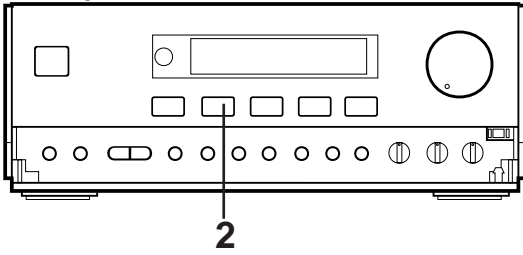

Preamplifier/Tuner

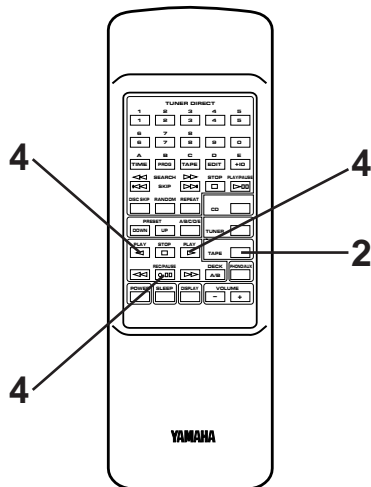
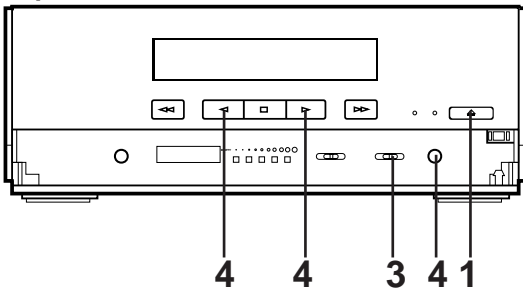

Tape Deck



Erasing recorded tapes

- 1** Load the tape to be erased into the cassette compartment.
- 2** Press the TAPE input selector button.
- 3** Set the reverse mode switch to  to erase only one side and to  (or ) to erase both sides.
- 4** Press the REC/PAUSE button, then press the play  button to erase side A of the tape, or the play  button to erase side B.

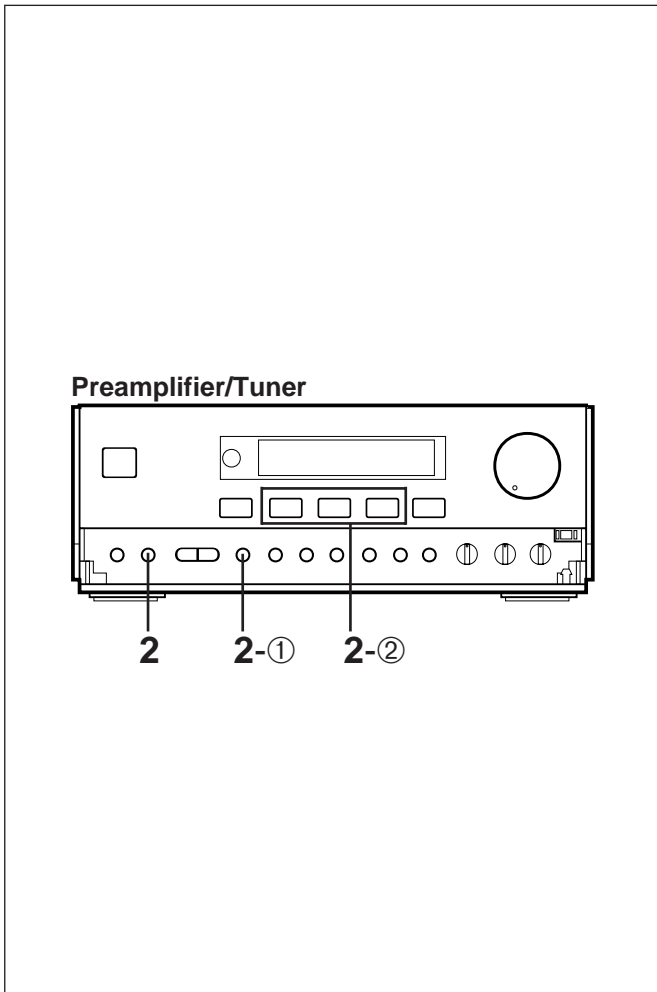

Timer play

By using the built-in timer, you can set the time when the unit turns on and a source begins playing automatically, and the time when the unit turns off automatically.

- 1 Prepare the source to be played.

For tuner:

Tune in to the station you will listen to.

For tape deck:

Load a tape into the cassette compartment.

For CD player:

Load a disc on the disc table. If more than one disc are loaded on the disc table, select the disc by using the disc select buttons or the DISC SKIP button.

- 2 Press the DISPLAY button.

Whenever the DISPLAY button is pressed, the display mode changes as follows. At each mode, make a setting for the timer play, referring to the setting procedure described below.

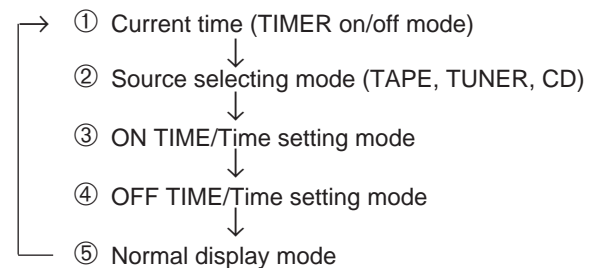

* The display mode will be changed to the next mode after about 8 seconds elapse automatically. If the mode is changed before the setting is completed, call the mode again by pressing the DISPLAY button once or more.

Setting procedure:

- ① **At the display of current time**
Check to be sure that the current time is correct, and press the TIMER button so that "TIMER" appears on the display.
- ② **At source selecting mode**
Select the source (TAPE, TUNER or CD) to be played by pressing the corresponding input selector button.
* If "TUNER" is selected, soon it is changed to the frequency display mode. In this mode, you can select the station to listen to with the timer play by using the BAND button, A/B/C/D/E button and TUNER PRESET DOWN/UP buttons.

HOW TO USE THE BUILT-IN TIMER

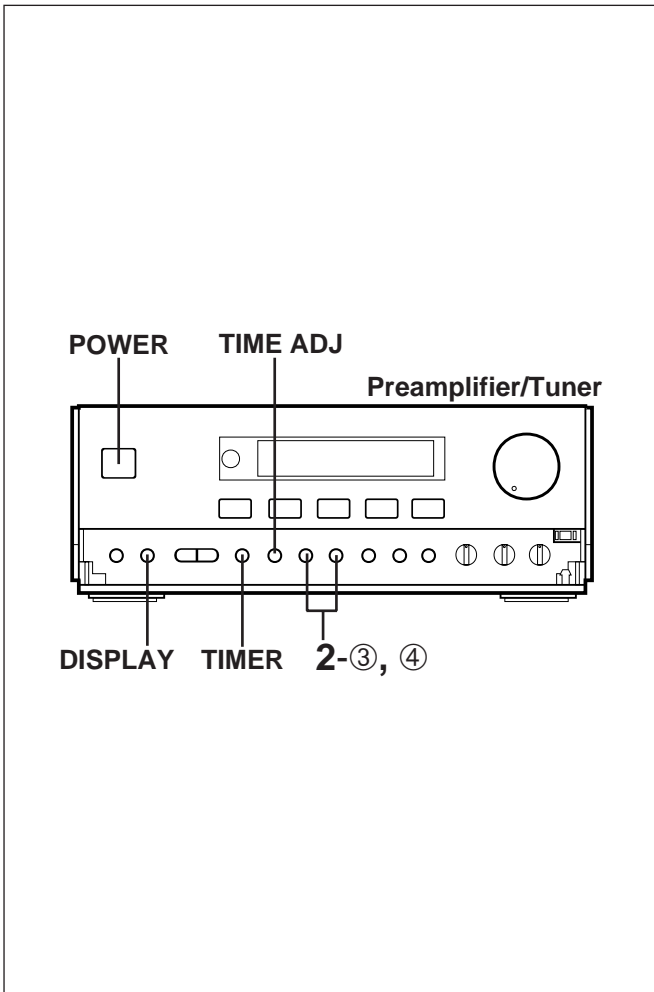

③ **At ON TIME/time setting mode**
["ON TIME" appears on the display, and soon it is changed to a time setting mode.]
Set to the time when the timer play begins by using the HOUR button and the MINUTE button.

④ **At OFF TIME/time setting mode**
["OFF TIME" appears on the display, and soon it is changed to a time setting mode.]
If necessary, set to the time when you want to finish the timer play (to turn this unit off) by using the HOUR button and the MINUTE button. Even if you do not set the time, it has already been set so that the timer play finishes after 1 hour.

* The TIMER button functions also in the time (ON TIME or OFF TIME) setting mode.

3 If you will not use this unit until the timer play begins, turn the power off by pressing the POWER switch or the TIMER button.

Note

If a timer play setting is made and the power is not turned off, the source set for the timer play will begin playing when the time comes in place of the source played at that time.

To cancel the timer play setting

After the timer play is finished, press the DISPLAY button to call the current time. While the current time is displayed, press the TIMER button so that "TIMER" goes out from the display.

If it is not canceled, the system will be turned on at the same time every day, so it can be used as an alarm. However, if you will be out at that time, cancel the timer play setting.

* Unless the AC supply lead is unplugged or there is a power failure for more than 30 minutes, the time set on the timer will be retained until it is reset.

How to make time setting in the ON TIME or OFF TIME mode

For the hour:

Press the HOUR button to change the hour to a higher value. Press and hold to change continuously.

To change the hour to a lower value, while pressing the TIME ADJUST button, press the HOUR button.

For the minute:

Use the MINUTE button and operate it in the same way as you did to change the hour.

HOW TO USE THE BUILT-IN TIMER

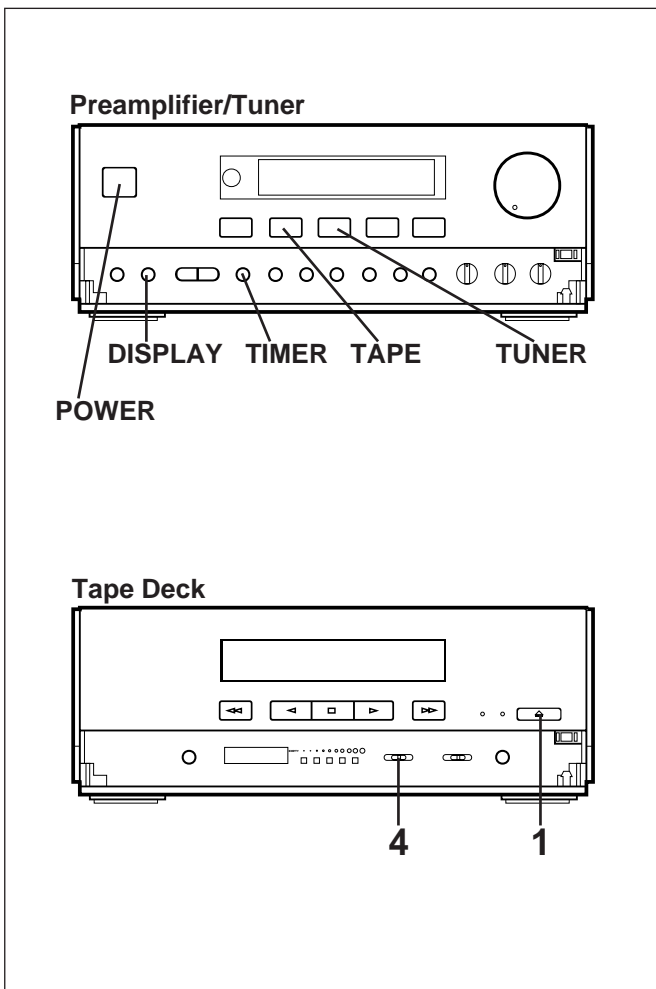

Timer recording (To record a tuner program)

- 1 Load a blank tape into the cassette compartment.
- 2 Tune to the station of which program you want to record.
- 3 Follow step 2 of the "Timer play" on pages 37 and 38.
 - * However, in step 2-②, press the TAPE input selector button twice so that "REC" flashes on the display. While "REC" is flashing, press the TUNER input selector button.
- 4 If desired, change the setting of the reverse mode switch and the Dolby NR switch.
- 5 If you will not use this unit until the timer recording begins, turn the power off by pressing the POWER switch or the TIMER button.

To confirm the timer time setting

Press the DISPLAY button.

To cancel the setting of timer recording

Press the DISPLAY button once or more so that "REC" flashes on the display. While "REC" is flashing, press the TAPE input selector button.

* Unless the AC supply lead is unplugged or there is a power failure for more than 30 minutes, the time set on the timer will be retained until it is reset.

Note

When the timer recording is finished, the timer setting is automatically canceled to avoid repeating timer recording of the same setting.

HOW TO USE THE BUILT-IN TIMER

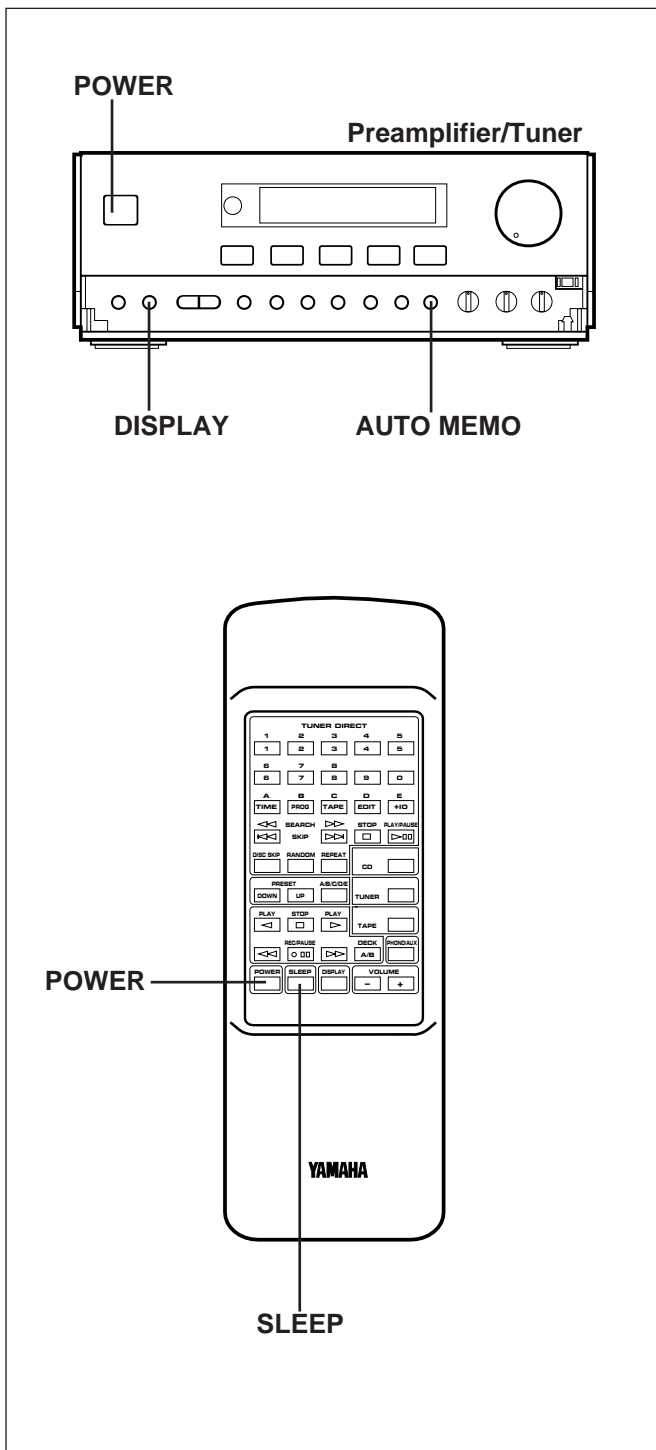

Sleep timer operation

This unit can be turned off automatically.

- 1 Play the desired sound source.
- 2 Press the SLEEP button. "SLEEP" appears on the display, and soon it is replaced by "120".
- 3 Press the SLEEP button repeatedly until the desired sleep time appears in the display. The display will change as described below. (Time is displayed by the minute.)

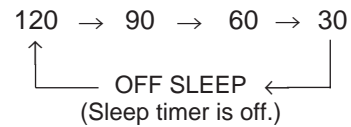

- * The original display mode will resume about 4 seconds after the selection is made.
- * The SLEEP indicator illuminates to indicate that the sleep timer is on.

- 4 The unit will turn off automatically when the preset sleep time has passed.

To confirm the sleep time setting

Press the SLEEP button once. "SLEEP" appears on the display, and soon it is replaced by the remaining time of the preset sleep time.

To change the sleep time

While the SLEEP indicator illuminates, press the SLEEP button repeatedly until the desired time appears.

To stop the sleep timer operation

Press the POWER switch, or press the SLEEP button repeatedly until "OFF SLEEP" appears on the display. (The SLEEP indicator will go out.)

To set the sleep time using front panel buttons

First press the DISPLAY button to display the current time. Within 7 seconds, press the AUTO MEMO button. Whenever the AUTO MEMO button is pressed, the sleep time changes.

Using the timer and the sleep timer at the same time

- 1 Prepare timer playback. (See pages 37 and 38.)
 - * Do not turn the power of this unit off after the timer setting is finished.

- 2 Press the SLEEP button and set the sleep time.

When the sleep timer operation finishes, the timer will function to turn the source on at the preset time.

Note

Do not set the timer time so that the timer will start during sleep timer operation. (Since sleep timer operation has priority, the timer will not operate.)

USING EXTERNAL UNITS

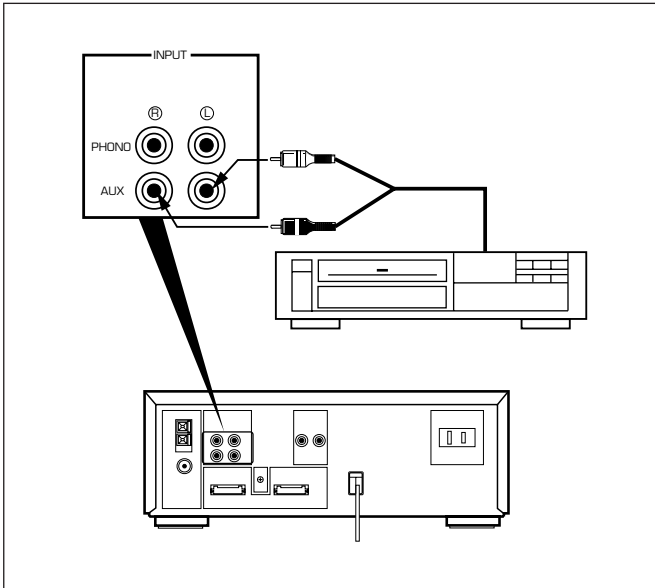

Auxiliary (AUX)

- 1 Connect the output lead of a video cassette player, video disc player, etc. to the AUX inputs of this unit. (red → right channel, white → left channel)
- 2 Press the AUX input selector button.
- 3 Operate the unit connected to the AUX inputs.
- 4 Start recording with this unit, if so desired. (See page 35.)

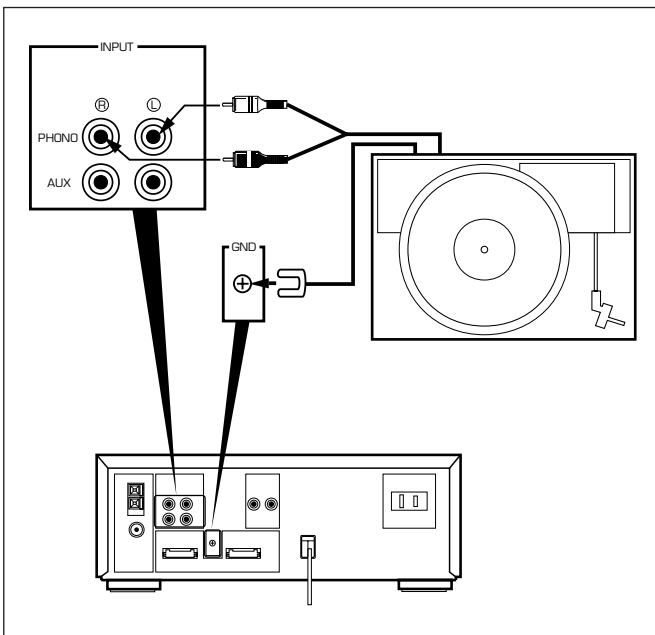

Turntable (PHONO)

- 1 Connect the output lead of a turntable. (red → right channel, white → left channel)
- 2 Connect the GND lead of a turntable.
- 3 Press the PHONO input selector button.
- 4 Operate the turntable.
- 5 Start recording with this unit, if so desired. (See page 35.)

USING EXTERNAL UNITS

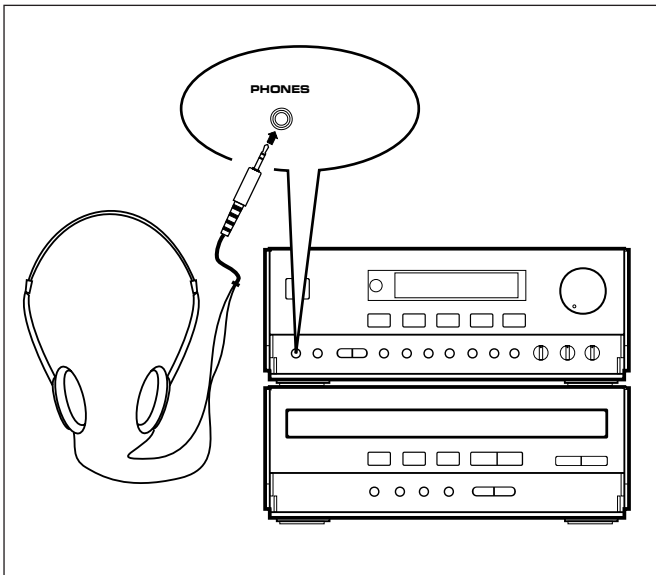

Headphones

- Be sure that your headphones have a 3.5 mm (1/8") diameter plug and are between 16 ohms and 50 ohms impedance. Recommended impedance is 32 ohms.
- When listening with headphones privately, press the POWER switch of the power amplifier to turn it off. Adjust the VOLUME control for desired volume.

MAINTENANCE

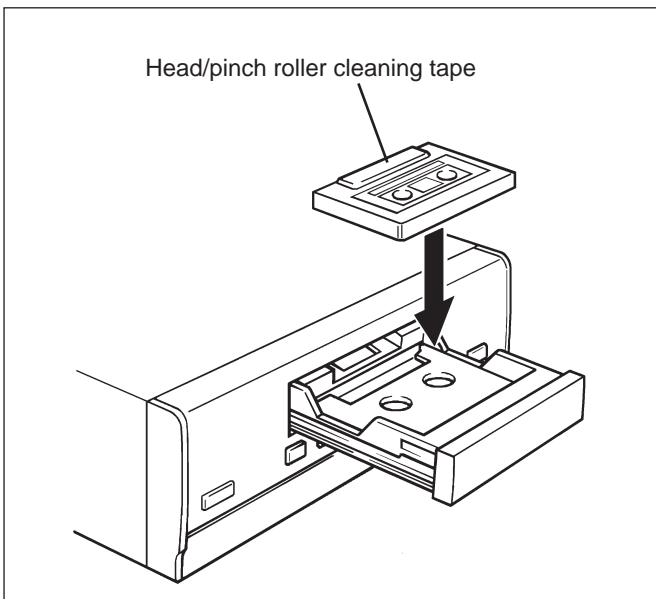

Internal care

- Dirty heads, capstans and pinch rollers can cause poor sound and tape jams. Clean these parts with a commercially available head/pinch roller cleaning tape.
- After long use, the deck's heads and capstans may become magnetized, causing poor sound. Demagnetize these parts once every 30 hours of playing/recording time by using a commercial tape head demagnetizer. Read the demagnetizer's instructions carefully before use.

External care

- Periodically clean the surfaces of this system, especially the top panel of the power amplifier to prevent the ventilation holes from being blocked with dust etc.
- Do not use chemically treated cleaning cloths or other chemicals. (See "Precautions".)

SPECIFICATIONS

As a part of policy of continuous improvement, YAMAHA reserves the right to make design and specification changes for product improvement without prior notice. The performance specification figures indicated are nominal values of production units.

■ Preamplifier/Tuner (CTX-S90)

Input Sensitivity/Impedance	
PHONO MM	2.5 mV/47 k-ohms
AUX	150 mV/25 k-ohms
Headphone Output Impedance	68 ohms
Total Harmonic Distortion (20 Hz to 20 kHz)	
AUX to LINE OUT	0.007%
Signal-to-Noise Ratio (IHF-A Network)	
AUX (Input Shorted)	102 dB
Output voltage	500 mV
Tone Control Characteristics	
BASS: Boost/cut	±10 dB (50 Hz)
TREBLE: Boost/cut	±10 dB (20 kHz)
Tuning Range	
FM	
[U.S.A. and Canada models]	87.5 to 107.9 MHz
[Europe and General models]	87.5 to 108.0 MHz
AM (MW)	
[U.S.A., Canada and General models]	530 – 1,710 kHz
[Europe model]	531 – 1,611 kHz
LW	
[Europe model only]	153 – 288 kHz
Usable Sensitivity	
FM (75 ohms)	
(30 dB S/N Quieting, 1 kHz, 100% mod.)	
[Except Europe model]	1.2 µV (12.8 dBf)
(DIN, Mono, S/N 26 dB) [Europe model]	1.5 µV
AM (MW)	280 µV/m
LW	560 µV/m
Power Supply	
[U.S.A. and Canada models]	AC 120V, 60 Hz
[Europe model]	AC 230V, 50 Hz
[General model]	AC 110/120/220/240V, 60/50 Hz
Power consumption	25W
Dimensions (W x H x D)	280 x 107.5 x 339.5 mm (11" x 4-1/4" x 13-3/8")
Weight	3.8 kg (8 lbs. 6 oz.)

■ Power amplifier (MX-S90)

Minimum RMS Output Power per Channel	
6 ohms, 20 Hz to 20 kHz, 0.04% THD	70W+70W
6 ohms, 1 kHz, 10% THD	
[U.S.A., Canada and General models only]	100W+100W
DIN Standard Output Power per Channel [Europe model only]	
4/6 ohms, 1 kHz, 1% THD	85/80W
IEC Power [Europe model only]	
6 ohms, 1 kHz, 0.1% THD	80W
Total Harmonic Distortion (20 Hz to 20 kHz)	
(35W/6 ohms)	0.04%
Signal-to-Noise Ratio (IHF-A Network)	105 dB
Power Supply	
[U.S.A. and Canada models]	AC 120V, 60 Hz
[Europe model]	AC 230V, 50 Hz
[General model]	AC 110/120/220/240V, 60/50 Hz
Power consumption	
[U.S.A. and Canada models]	150W
[Europe and General models]	160W
Dimensions (W x H x D)	280 x 107.5 x 332.4 mm (11" x 4-1/4" x 13-1/16")
Weight	5.6 kg (12 lbs. 5 oz.)

■ CD player (CDC-S90)

Power Source	AC supplies from CTX-S90
Type	3 DISC Carousel Auto-changer
Signal Readout	
.....	Non-contact, 3-beam semi-conductor laser pick-up
D/A Converter	1-bit DAC
Filter	8-time oversampling 18-bit digital filter
Wow and Flutter	Below measurable limits
Dimensions (W x H x D)	280 x 107.5 x 323 mm (11" x 4-1/4" x 12-11/16")
Weight	3.8 kg (8 lbs. 6 oz.)

■ Tape Deck (KX-S90)

Power Source	AC supplies from CTX-S90
Type	Auto Reverse 4-Track 2-Channel recording and playback stereo Cassette Deck
Heads	REC/PB : Hard Permalloy Erase : Double Gap Ferrite
Motor	DC servo motor
Wow and Flutter	±0.19%, W.PEAK 0.09%, W.RMS
Fast Winding Time (C-60 Tape)	About 120 seconds
Frequency Response (-20 dB)	
.....	30 – 16,000 Hz ±3 dB (Normal)
.....	30 – 17,000 Hz ±3 dB (CrO ₂)
.....	30 – 19,000 Hz ±3 dB (Metal)
Signal-to-Noise Ratio	58 dB (Dolby NR OFF) 66 dB (Dolby B NR ON) 74 dB (Dolby C NR ON)
Harmonic Distortion	No more than 1.2%
Channel Separation (Input Shorted 1 kHz)	
.....	More than 40 dB
Crosstalk (Input Shorted 125 Hz)	More than 55 dB
Dimensions (W x H x D)	280 x 107.5 x 323 mm (11" x 4-1/4" x 12-11/16")
Weight	3.5 kg (7 lbs. 11 oz.)

■ Speaker (NX-S90)

Type	Active Servo Processing type
Speakers	16 cm (6-5/16") woofer 6.5 cm (2-9/16") tweeter 1.1 cm (7/16") super tweeter
Frequency Range	35 – 30,000 Hz
Sound Pressure Level	88 dB
Maximum Power Handling Capacity	120W
Impedance	6 ohms
Dimensions (W x H x D)	210 x 430 x 250 mm (8-1/4" x 16-15/16" x 9-13/16")
Weight	6.7 kg (14 lbs. 12 oz.) x 2

TROUBLESHOOTING

If your unit fails to operate normally, check the following points to determine whether the fault can be corrected by the simple measures suggested. If it cannot, or if the fault is not listed in the SYMPTOM column, disconnect the power cord and contact your authorized YAMAHA dealer or service center for help.

Should be service required, the servicer will need all four pieces (CTX-S90, MX-S90, CDC-S90, KX-S90).

	SYMPTOM	CAUSE	REMEDY
PREAMPLIFIER/TUNER	No power even if the POWER switch is pressed.	AC supply lead is not plugged in.	Plug in the AC supply lead.
	No sound from one speaker	Loose speaker connections.	Connect properly.
	No sound from speakers.	Internal protection circuit is functioning.	Unplug the AC supply lead from the wall AC outlet, and then plug in again.
	Excessive static in FM broadcasts.	Interference from starting motor of nearby car.	Position the FM antenna as high and as far away from nearby roads as possible. Connect using a coaxial cable.
		Interference from thermostat of nearby electrical appliance.	
	Noise increases during stereo broadcasts.	Antenna input is too weak due to obstructions or excessive distance from broadcasting station.	Check antenna connections. Install a multi-element type FM antenna if possible.
	Stereo broadcasts are noisy and STEREO indicator blinks on and off.	Insufficient antenna input.	Install an antenna appropriate for the electric field strength of your area.
	Cannot select preset stations.	Preset memory has been erased.	Reprogram memory presets.
	Buzzing or static during AM (LW or MW) broadcasts.	Interference from source such as lightning, fluorescent lights, electric motors or thermostat of nearby electrical appliance.	Problem is difficult to eliminate but can be lessened by grounding MW/LW (AM) loop antenna.
		TV or microprocessor is being used nearby.	Move away from TV or microprocessor.
	AM (LW or MW) broadcast sensitivity is poor.	Radio signal is weak or antenna is not properly connected.	Properly connect MW/LW (AM) loop antenna.
			Change orientation of MW/LW (AM) loop antenna.
			Install an external MW/LW (AM) antenna.
Can't set timer.	Current time is not set.	Set current time.	
This unit will not operate properly.	The internal microcomputer has been frozen by an external electric shock (lightning, excessive static electricity, etc.) or power supply with low voltage.	Unplug the AC supply lead from the wall AC outlet, and then plug in again after about one minute.	
CD PLAYER	Play does not begin even if disc is loaded.	Disc is upside down.	Load disc label side up.
		Disc is dirty.	Clean disc.
	No sound.	Input selector setting is incorrect.	Select the CD input selector button.
	Sound stops suddenly (always at same spot).	Disc is dirty.	Clean disc.
Volume set too high.		Lower volume.	
TAPE DECK	Tape won't move during playback or recording.	Slack tape wrapped around pinch roller.	Take up slack with a pencil before using.
	Can't record.	Erasure prevention tab is broken off.	Replace tape or cover erasure prevention hole with cellophane tape.
		Head is dirty.	Clean heads.
	Sound is distorted or fades out.	Head is dirty.	Clean heads.
		Head has become magnetized.	Demagnetize heads with head eraser.
		Tape is worn.	Replace tape.
	Poor sound quality.	Dolby NR switch is set to wrong position.	Set to positions matching those used when tape was recorded.
	Stereo balance is poor.	Head is dirty.	Clean heads.
	Excessive noise.	Head is dirty.	Clean heads.
		Head has become magnetized.	Demagnetize heads with head eraser.
		Tape is worn.	Replace tape.
	Tape travel stops in middle of playback or recording.	Slack tape coming out of cassette shell.	Take up slack by turning reels with a pencil.
		Tape is creased or torn.	Replace with new tape.
Endless tape is being used.		Don't use endless tapes.	
Can't find the beginning of desired selections on tape.	Silent gaps between selections are too short.	The function for searching the beginning of desired selections won't operate unless the silent gaps between selections are at least four seconds long.	
	Excessively soft passages in middle of selections.		
	Conversation etc. is recorded.		
REMOTE CONTROL	Remote control doesn't work.	Batteries are dead.	Replace batteries.
		Remote control is too far away or is being used at incorrect angle.	Use within 6 m and 60° radius.
		Direct sunlight or lighting (of an inverter type of fluorescent lamp etc.) is striking the remote control sensor of the main unit.	Change position of the main unit.
	TV functions strangely when the remote control is used.	Remote control is being used near TV set with a remote control sensor.	Move TV farther away or cover its remote control sensor.

ACTIVE SERVO TECHNOLOGY (for Speaker System NX-S90 only)

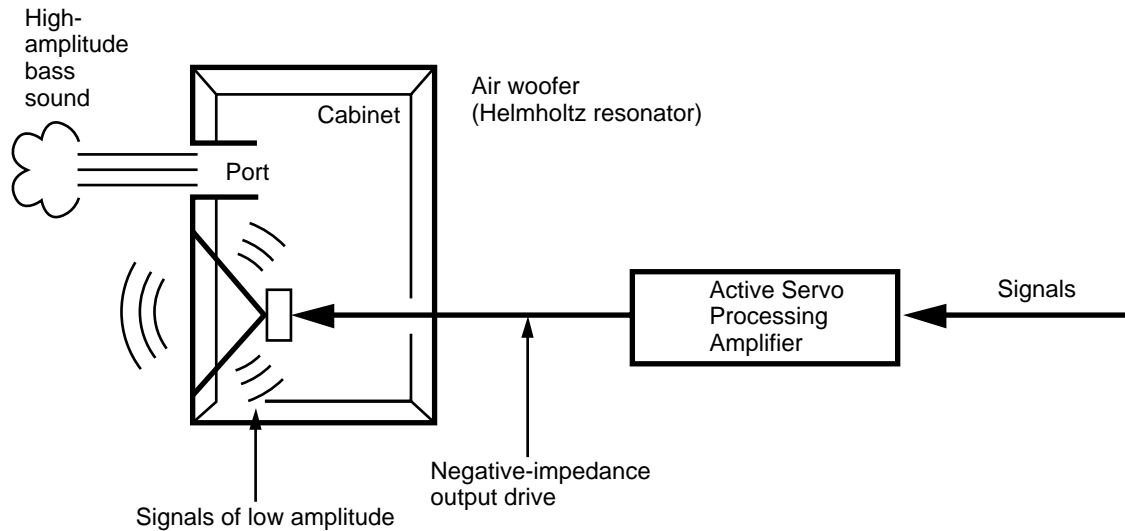

The theory of the Active Servo Technology is based upon two major factors, the Helmholtz resonator and negative-impedance drive. Active Servo Processing speakers reproduce the bass frequencies through an "air woofer", which is a small port or opening in the speaker's cabinet. This opening is used instead of, and performs the functions of, a woofer in a conventionally designed speaker system. Thus, signals of low amplitude within the cabinet can, according to the Helmholtz resonance theory, be output from this opening as waves of great amplitude if the design is such that the size of the opening and the volume of the cabinet are in the correct proportion to satisfy a certain ratio. In order to accomplish this, moreover, the amplitudes within the cabinet must be both precise and of sufficient power because these amplitudes must overcome the "load" presented by the air that exists within the cabinet.

Thus it is this problem that is resolved through the employment of a design in which the amplifier functions to supply the signals. If the electrical resistance of the voice coil is reduced to zero, the movement of the speaker unit would become linear with respect to signal voltage, and, to accomplish this, a special negative-impedance output-drive amplifier for subtracting output impedance of the amplifier is used.

By employing negative-impedance drive circuits, the amplifier is able to generate precise, low-amplitude low-frequency waves with superior damping characteristics, and these waves are then radiated from the cabinet opening as high-amplitude signals. The system can, therefore, by employing the negative-impedance output drive amplifier and a speaker cabinet with the Helmholtz resonator, reproduce an extremely wide range of frequencies with amazing sound quality and less distortion.

The features described above are combined to be the fundamental structure of the Active Servo Technology.

YAMAHA

YAMAHA ELECTRONICS CORPORATION, USA 6660 ORANGETHORPE AVE., BUENA PARK, CALIF. 90620, U.S.A.
YAMAHA CANADA MUSIC LTD. 135 MILNER AVE., SCARBOROUGH, ONTARIO M1S 3R1, CANADA
YAMAHA ELECTRONIK EUROPA G.m.b.H. SIEMENSSTR. 22-34, 25462 RELLINGEN BEI HAMBURG, F.R. OF GERMANY
YAMAHA ELECTRONIQUE FRANCE S.A. RUE AMBROISE CROIZAT BP70 CROISSY-BEAUBOURG 77312 MARNE-LA-VALLÉE CEDEX02, FRANCE
YAMAHA ELECTRONICS (UK) LTD. YAMAHA HOUSE, 200 RICKMANSWORTH ROAD WATFORD, HERTS WD1 7JS, ENGLAND
YAMAHA SCANDINAVIA A.B. J A WETTERGRENS GATA 1, BOX 30053, 400 43 VÄSTRA FRÖLUNDA, SWEDEN
YAMAHA MUSIC AUSTRALIA PTY, LTD. 17-33 MARKET ST., SOUTH MELBOURNE, 3205 VIC., AUSTRALIA

YAMAHA CORPORATION