

YAMAHA YST-99CD

*Natural Sound Tabletop CD Stereo System
Powerful Bass Sound with Active Servo Technology System
Program, Repeat and Resume play
Built-In Timer Function
19 Preset Station Memories
Remote Control Capabilities*

Thank you for purchasing the YAMAHA YST-99CD Tabletop CD Stereo System

TABLE OF CONTENTS

Safety Instructions	2
The Active Servo Technology System	8
Supplied Accessories	8
Connections	8
Installation Precaution	9
Using The Remote Control Transmitter	10
Controls and Their Functions	11
Current Time Setting	12
Operation	12
Notes on Handling Disc	17
Troubleshooting	18
Specifications	19

OWNER'S MANUAL



IMPORTANT

Please record the serial number of your unit in the space below.

Model: **YST-99CD**

Serial No.:

The serial numbers are located on the bottom of the units.
Retain this Owner's Manual in a safe place for future reference.

マイコン変更及び誤記訂正

SAFETY INSTRUCTIONS

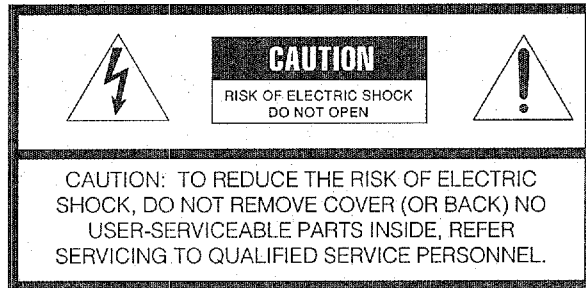

● Explanation of Graphical Symbols



The lightning flash with arrowhead symbol, within an equilateral triangle, is intended to alert you to the presence of uninsulated "dangerous voltage" within the product's enclosure that may be of sufficient magnitude to constitute a risk of electric shock to persons.

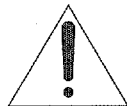

The exclamation point within an equilateral triangle is intended to alert you to the presence of important operating and maintenance (servicing) instructions in the literature accompanying the appliance.

WARNING

To reduce the risk of fire or electric shock, do not expose this appliance to rain or moisture.

- 1** Read Instructions — All the safety and operating instructions should be read before the appliance is operated.
- 2** Retain Instructions — The safety and operating instructions should be retained for future reference.
- 3** Heed Warnings — All warnings on the appliance and in the operating instructions should be adhered to
- 4** Follow Instructions — All operating and other instructions should be followed.
- 5** Water and Moisture — The appliance should not be used near water — for example, near a bathtub, washbowl, kitchen sink, laundry tub, in a wet basement, or near swimming pool, etc.

2

6 Carts and Stands — The appliance should be used only with a cart or stand that is recommended by the manufacturer.

6A An appliance and cart combination should be moved with care. Quick stops, excessive force, and uneven surfaces may cause the appliance and cart combination to overturn.



7 Wall or Ceiling Mounting — The appliance should be mounted to a wall or ceiling only as recommended by the manufacturer.

8 Ventilation — The appliance should be situated so that its location or position does not interfere with its proper ventilation. For example, the appliance should not be situated on a bed, sofa, rug or similar surface, that may block the ventilation openings; or placed in a built-in installation, such as a bookcase or cabinet that may impede the flow of air through the ventilation openings.

9 Heat — The appliance should be situated away from heat sources such as radiators, stoves, or other appliances that produce heat.

10 Power Sources — The appliance should be connected to a power supply only of the type described in the operating instructions or as marked on the appliance.

11 Power-Cord Protection — Power-supply cords should be routed so that they are not likely to be walked on or pinched by items placed upon or against them, paying particular attention to cords at plugs, convenience receptacles, and the point where they exit from the appliance.

12 Cleaning — The appliance should be cleaned only as recommended by the manufacturer.

13 Nonuse Periods — The power cord of the appliance should be unplugged from the outlet when left unused for a long period of time.

14 Object and Liquid Entry — Care should be taken so that objects do not fall into and liquids are not spilled into the inside of the appliance.

15 Damage Requiring Service — The appliance should be

serviced by qualified service personnel when:

- A. The power-supply cord or the plug has been damaged; or
- B. Objects have fallen, or liquid has been spilled into the appliance; or
- C. The appliance has been exposed to rain; or
- D. The appliance does not appear to operate normally or exhibits a marked change in performance; or
- E. The appliance has been dropped, or the cabinet damaged.

16 Servicing — The user should not attempt to service the appliance beyond those means described in the operating instructions. All other servicing should be referred to qualified service personnel.

17 Power Lines — An outdoor antenna should be located away from power lines.

18 Grounding or Polarization — The precautions that should be taken so that the grounding or polarization of an appliance is not defeated.

19 Outdoor Antenna Grounding — If an outside antenna or cable system is connected to the unit, be sure that antenna or cable system is grounded so as to provide some protection against voltage surges and built-up static charges. Section 810 of the National Electrical Code, ANSI/NFPA No. 70-1984, provides information with respect to proper grounding of the mast and supporting structure, grounding of the lead-in wire to an antenna discharge unit, size of grounding conductors, location of antenna-discharge unit, connection to grounding

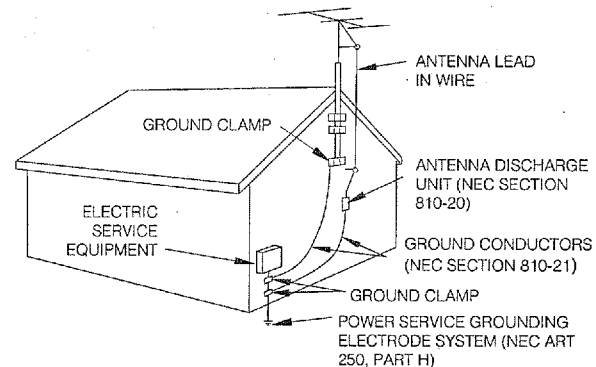

NEC - NATIONAL ELECTRICAL CODE

CAUTION: READ THIS BEFORE OPERATING YOUR YST-99CD

1. To ensure the finest performance, please read this manual carefully. Keep it in a safe place for future reference.
2. Install your unit in a cool, dry, clean place — away from windows, heat sources, and too much vibration, dust, moisture, or cold. Avoid sources of hum (transformers, motors.). To prevent fire or electrical shock, do not expose to rain and water.
3. Never open the cabinet. If a foreign object drops into the set, contact your dealer.
4. Do not use force on switches, knobs or cords. When moving the unit, first disconnect the power plug and the cords connecting the other equipment. Never pull the cord itself.
5. Do not attempt to clean the unit with chemical solvents; this might damage the finish. Use a clean, dry cloth.
6. Be sure to read the "troubleshooting" section on common operating errors before concluding that your unit is faulty.
7. **If your unit has a voltage selector (General model only), check that it is set to your local voltage before you plug it in. If not properly set, reset the switch to indicate your supply voltage.**

WARNING

DANGER

Invisible laser radiation when open and interlock failed or defeated.
Avoid direct exposure to beam.

CAUTION

Use of controls or adjustments or performance of procedures other than those specified herein may result in hazardous radiation exposure.

As the laser beam used in this compact disc player is harmful to the eyes, do not attempt to disassemble the cabinet. Refer servicing to qualified personnel only.

To avoid electrical shock, do not open the unit. Refer servicing to qualified personnel only.

DANGER: The use of optical instrument with this product will increase eye hazard.

FCC INFORMATION (U.S.A.)

1. **IMPORTANT NOTICE: DO NOT MODIFY THIS UNIT!**
This product, when installed as indicated in the instructions contained in this manual, meets FCC requirements. Modifications not expressly approved by Yamaha may void your authority, granted by the FCC, to use the product.
2. **IMPORTANT:** When connecting this product to accessories and/or another product use only high quality shielded cables. Cable/s supplied with this product **MUST** be used. Follow all installation instructions. Failure to follow instructions could void your FCC authorization to use this product in the USA.
3. **NOTE:** This product has been tested and found to comply with the requirements listed in FCC Regulations, Part 15 for Class "B" digital devices. Compliance with these requirements provides a reasonable level of assurance that your use of this product, in a residential environment, will not result in harmful interference with other electronic devices.
This equipment generates/uses radio frequencies and, if not installed and used according to the instructions found in the users manual, may cause interference harmful to the operation of other electronic devices. Compliance with FCC regulations does not guarantee that interference will not occur in all installations. If this product is found to be the source of interference, which can be determined by turning the product "OFF" and "ON", please try to eliminate the problem using one of the following measures:

Relocate either the product generating the interference or the device that is being affected by the interference.

Utilize power outlets that are on different branch (circuit breaker or fuse) circuits or install AC line filter/s.

In the case of radio or TV interference, relocate/reorient the antenna. If the antenna lead-in is 300 ohm ribbon lead, change the lead-in to coaxial type cable. If these corrective measures do not produce satisfactory results, please contact your local retailer that is authorized to distribute this type of product. If you cannot locate the appropriate retailer, please contact *Yamaha Electronics Corp., U.S.A. 6722 Orangethorpe Ave. Buena Park, CA 90620.

The above statements apply **ONLY** to those products distributed by Yamaha Corporation of America or its subsidiaries.

WARNING: CHEMICAL CONTENT NOTICE!

The solder used in the manufacture of this product contains LEAD. In addition, the electrical/electronic and/or plastic (where applicable) components may also contain traces of chemicals found by the California Health and Welfare Agency (and possibly other entities) to cause cancer and/or birth defects or other reproductive harm.

DO NOT REMOVE ANY ENCLOSURE COMPONENTS! There are no user serviceable parts inside. All service should be performed by a service representative authorized by Yamaha to perform such service.

IMPORTANT MESSAGE: Yamaha strives to produce products that are both user safe and environmentally "friendly". We sincerely believe that our products meet these goals. However, in keeping with both the spirit and the letter of various statutes we have included the messages shown above and others in various locations in this manual.

Note to CATV system installer:

This reminder is provided to call the CATV system installer's attention to Article 820-40 of the NEC in USA (and to the Canadian Electrical Code in Canada) that provides guidelines for proper grounding and, in particular, specifies that the cable ground shall be connected to the grounding system of the building, as close to the point of cable entry as practical.

1

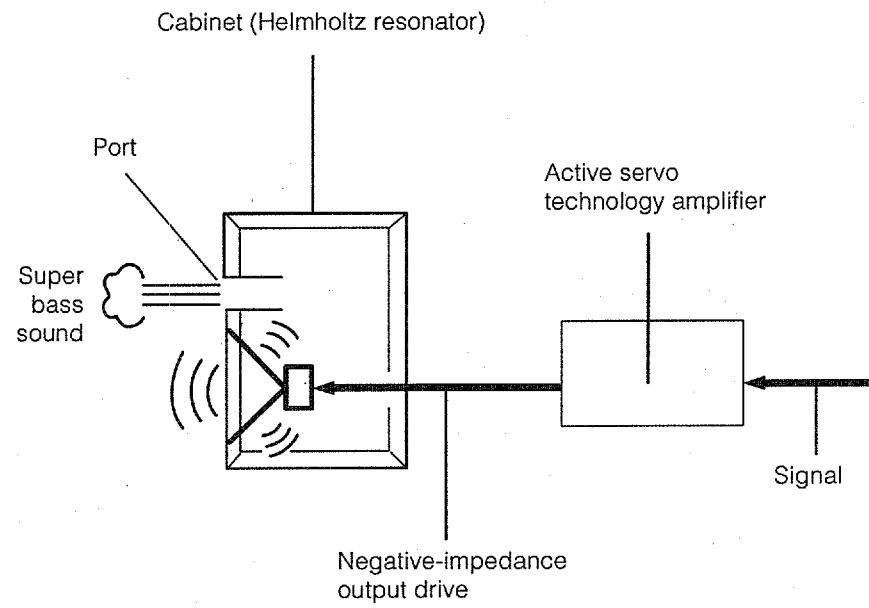

2

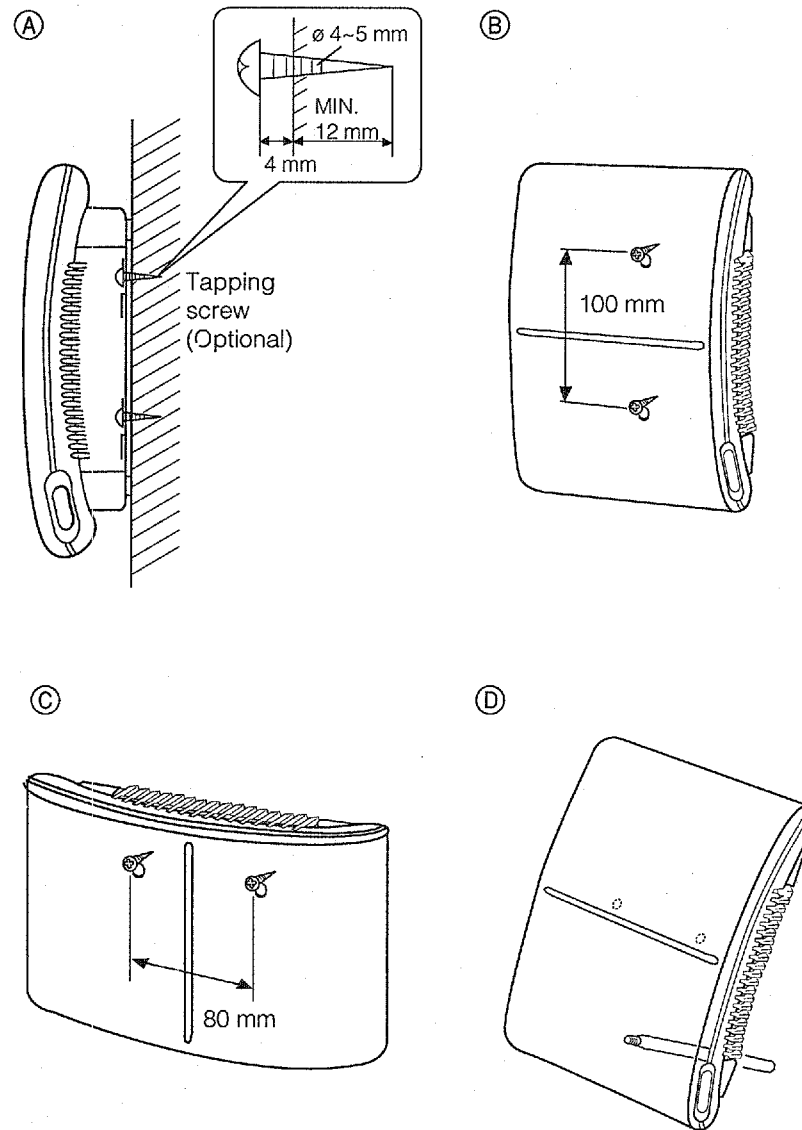

3

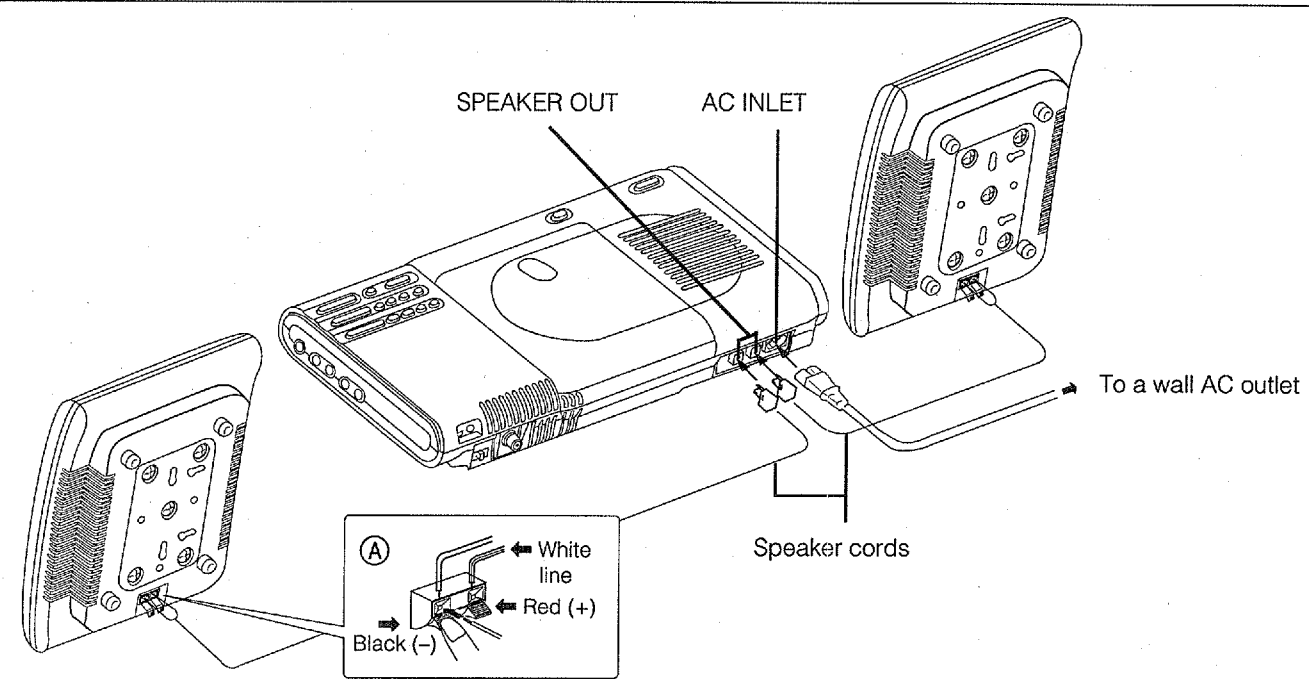

4

(A)

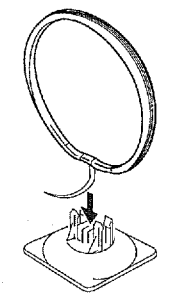

(B)

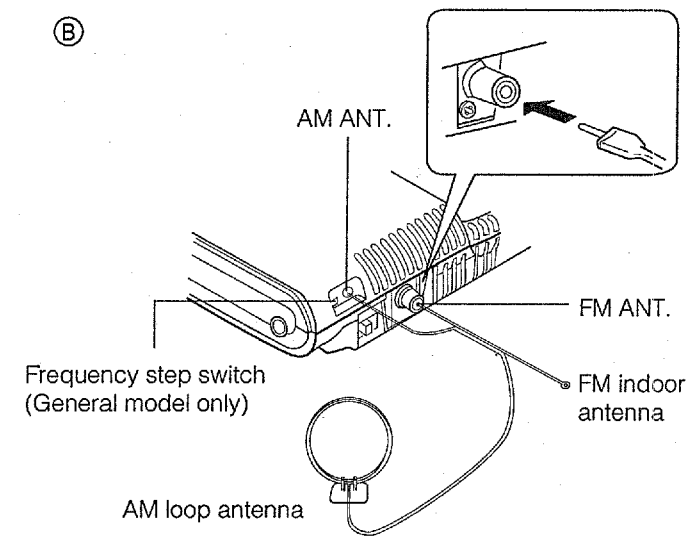

(C)

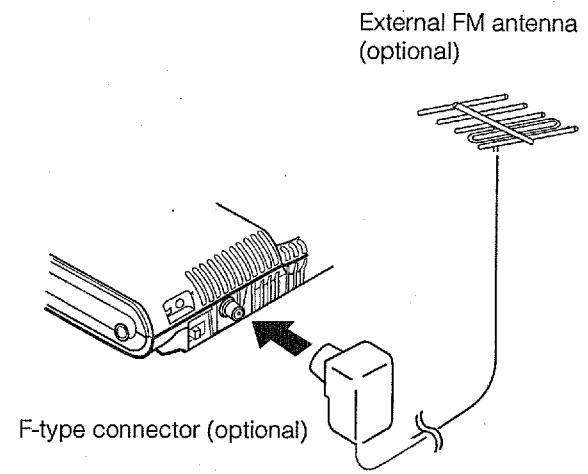

5

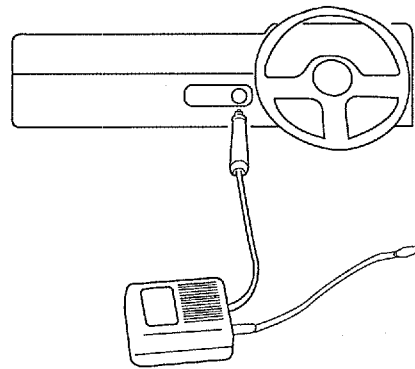

Use only DCA-12
(YAMAHA).

Left side of the unit

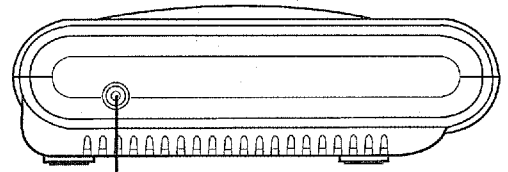

DC IN jack

Right side of the unit

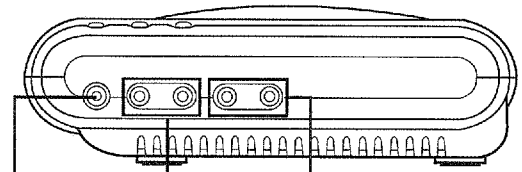

PHONES INPUT A/B TAPE IN/OUT

6

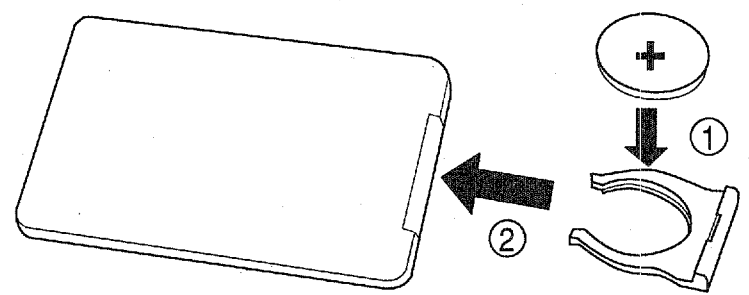

7

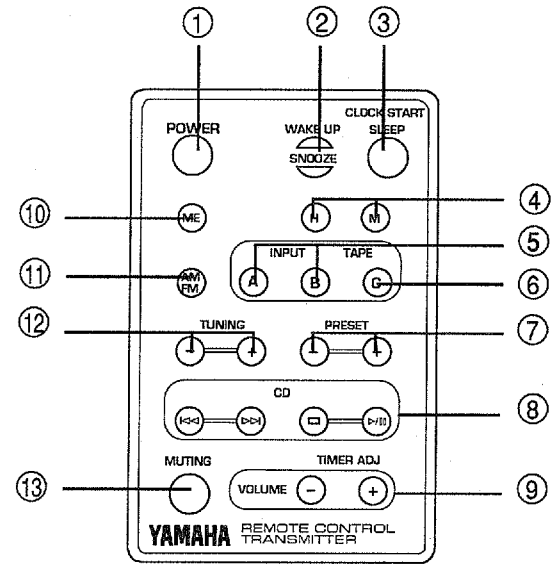

Top panel of the unit

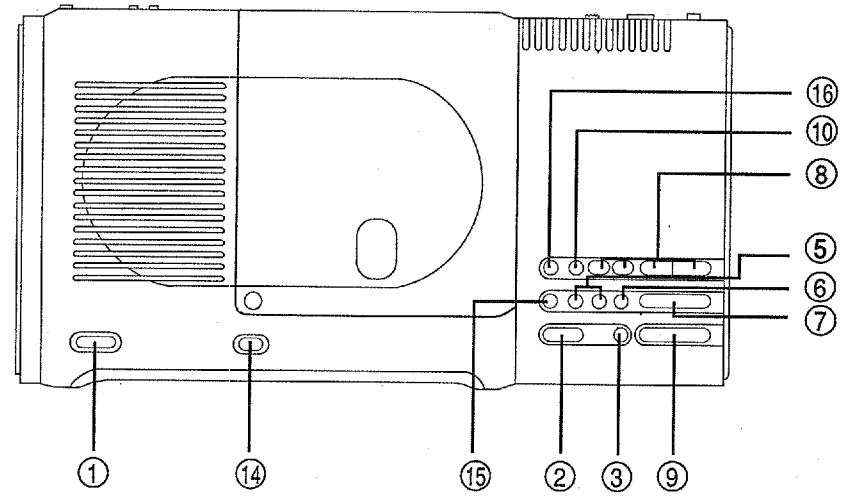

Front side of the unit

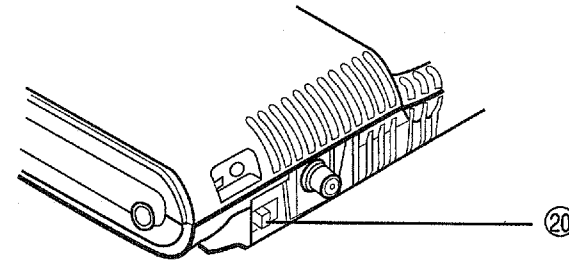
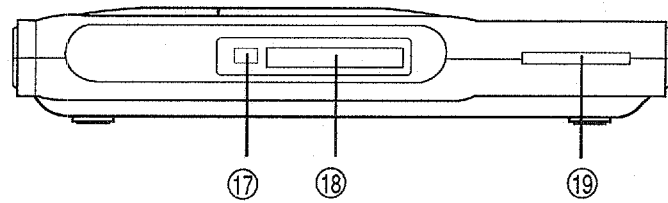

THE ACTIVE SERVO TECHNOLOGY SYSTEM

(See Fig. 1.)

The theory of the Active Servo Technology system is based upon two major factors, the Helmholtz resonator and negative-impedance drive. Active Servo Technology speakers reproduce the bass frequencies through a port, which is a small port or opening in the speaker's cabinet. This opening is used instead of, and performs the functions of, a woofer in a conventionally designed speaker system. Thus, signals of low amplitude within the cabinet can, according to the Helmholtz resonance theory, be output from this opening as waves of great amplitude if the design is such that the size of the opening and the volume of the cabinet are in the correct proportion to satisfy a certain ratio.

In order to accomplish this, moreover, the amplitudes within the cabinet must be both precise and of sufficient power because these amplitudes must overcome the "load" presented by the air that exists within the cabinet.

Thus it is that this problem is resolved through the employment of a design in which this Tabletop CD Stereo System functions to supply the signals. If the electrical resistance of the voice coil is reduced to zero, the movement of the speaker unit would become linear with respect to signal voltage, and, to accomplish this, a special negative-impedance output-drive amplifier for subtracting output impedance of the receiver is used.

By employing negative-impedance drive circuits, this receiver is able to generate precise, low-amplitude low-frequency waves with superior damping characteristics, and these waves are then radiated from the cabinet opening as high-amplitude signals. The system can, therefore, by employing the negative-impedance output drive amplifier and a speaker cabinet with the Helmholtz resonator, reproduce an extremely wide range of frequencies (45 Hz ~ 18 kHz) with amazing sound quality and less distortion.

The features described above, are combined to the fundamental structure of the Active Servo Technology system.

SUPPLIED ACCESSORIES

After unpacking, check that the following parts are included.

● Card-type Remote Control Unit.....	1
● Battery (CR2025)	1
● AC Cord	1
● AM Loop Antenna/FM Indoor Antenna	1
● Speaker Cables.....	2
● Speakers	2
● Speaker Stands	2

CONNECTIONS

SPEAKERS

■ SETTING UP THE SPEAKERS

(See Fig. 2.)

● Attaching the speakers to a wall

The speakers can be attached to a wall by using the hooks provided on the speakers' back panels. Screw in 2 tapping screws (\varnothing 4 ~ 5 mm), with a length of more than 16 mm, into a wall so that the heads of the screws protrude by about 4 mm from the surface of the wall.

(See Fig. 2 - (A).)

For upright configuration, see Fig. 2 - (B).

For side long configuration, see Fig. 2 - (C).

● Setting the speakers up on a rack or table

As shown in Fig. 2 - (D), the speakers can be stood in an upright configuration on either racks or tables, by attaching one of the supplied supports to the back of each speaker.

NOTES

- The speakers weigh 1.5 kg each. Do not attach them to thin plywoods or soft wall surface materials, as the screws may tear free from flimsy surfaces, causing the speakers to fall and be damaged, or resulting in personal injury.
- Do not fasten the screws to walls with adhesives or other unsound hardware. Long term use and vibrations may cause them to pull free.
- To avoid accidents resulting from tripping over loose speaker cables, fix them to the wall along with the speakers.

■ SPEAKER CONNECTION

(See Fig. 3.)

Connect the input terminals on the back of the speakers to the SPEAKER OUT terminals of this unit with the supplied speaker cords. Make sure to connect the left speaker cables to the L terminals and the right speaker cables to the R terminals.

To connect the supplied speaker cord to the speaker, press the speaker terminal lever and insert the bare end of the speaker cable into the terminal opening, making sure that the polarity (+ and -) markings are observed. If the polarity is reversed at either speaker, the sound will be distorted and will lack bass. (See Fig. 3 - (A).) The cord will be set when the lever is depressed. Lightly pull the speaker cables to make sure that the cables are properly connected.

AC INLET (See Fig. ③.)

Connect the one plug of supplied power cord to the AC INLET at the rear and the other plug to the wall AC outlet.

ANTENNA CONNECTION (See Fig. ④.)

When using the AM loop antenna

1. Attach the loop antenna to the antenna stand. (See Fig. ④ - ①.)
 2. Connect to the AM ANT jack of this unit. (See Fig. ④ - ②.)
 3. Adjust the direction of the AM loop antenna for best reception.
- Straighten the loop antenna cord.

When using the FM indoor antenna

1. Connect to the FM ANT jack of this unit. (See Fig. ④ - ③.)
 2. Check whether the broadcast is well received with combining the AM loop antenna cord and the FM indoor antenna cord.
 3. If the reception is weak, divide the AM loop antenna cord and the FM indoor antenna cord.
 4. Adjust the direction of the FM indoor antenna for better reception.
For example, when you have obtained a good direction of the antenna, fix the antenna on a wall with pins.
- Straighten the antenna.

External FM antenna (See Fig. ④ - ④.)

When the FM reception is weak, connect the external FM antenna to the FM ANT jack with the F-type connector. (The external FM antenna and F-type connector are optional.)

DC IN jack (See Fig. ⑤.)

Connect the optionally available car adaptor DCA-12 to this jack to use this unit in a car. Only the DCA-12 (YAMAHA) can be used for this jack.

PHONES jack (See Fig. ⑤.)

Connect the headphones plug into this jack for private listening.

When connecting other audio equipment

INPUT A and B (See Fig. ⑤.)

Connect the output jack of other audio equipment such as a headphone stereo to the INPUT A or B jack using an optionally available mini-plug cable.

- Turn off the unit when connecting.
- In case of connecting to the PHONES jack of other audio equipment, the sound is often distorted when the output level of the PHONES jack of other equipment is too high.
- Turntable cannot be connected to this jack.
- Use a stereo mini-plug cable without resistor.
- With the optionally available convert cable (Stereo mini-plug ↔ Pin jack), you can connect this unit to other audio equipment.

TAPE IN and OUT (See Fig. ⑤.)

Connect the TAPE IN jack of this unit to the output jack of a tape deck and the TAPE OUT jack to the input jack of the tape deck with the optionally available stereo mini-plug cable.

- Turn off the unit when connecting.
- When connecting to the MIC jack of a tape deck, the sound level from the speakers may be decreased.
- Use a stereo mini-plug cable with resistor when connecting to the MIC jack.

INSTALLATION PRECAUTION

- **The bottom of this unit is heat radiator board so do not touch this part.**
Install this unit in a well ventilated location, otherwise the unit will be damaged.
- Do not place the unit in a place subject to direct sunlight.
- Do not use the unit in the car of a high temperature.

On condensation

When this unit is brought into a warm room from previously cold surroundings, when the room temperature rises sharply or when the unit is exposed to direct wind from the air conditioner, condensation may form inside or pick-up lens of CD player, and the unit may not function properly. In this case, turn on the power of this unit and leave for few hours indoors.

On a protection circuit

This unit is built in the protection circuit to prevent the temperature of inside the unit from going up excessively. When the temperature of inside the unit goes up more than the designated one, the output from the speaker jacks is automatically cut. If the protection circuit operates, turn off the power of this unit and wait until the temperature of inside the unit goes down at an appropriate level.

When you use this unit outdoor or in a car

This unit is basically designed for indoor use, so when you use the unit outdoor or in a car please bear in mind the following notes.

- Do not use this unit in a place subject to shock, rain, dew or excessive dust.
- If the car is parked for a long time in the sun or in a cold location, the temperature inside the car will reach extreme levels. As the unit may not function properly in such a case, use it only after the ambient temperature has returned to normal.

Use this unit in the temperature from 5°C to 35°C.

- When you place this unit, make sure that the unit is level.
- The sound may be noisy by the influence of the ignition noise etc.
- The reception of the broadcast may be poor by the influence of an antenna etc.
- Do not use this unit while driving.
- If the unit is used at high power levels for an extended period while the engine is not running, the car battery may become exhausted.

USING THE REMOTE CONTROL TRANSMITTER

The remote control transmitter supplied with your receiver is designed to control the features of the receiver. Note that features such as the clock, memory, AM/FM, tuning (auto or manual), and muting functions are controllable only from the remote control transmitter.

BATTERY INSTALLATION (See Fig. 6.)

The remote control transmitter uses 1 battery (CR2025). Install the battery according to the illustration. Make sure that the battery is properly installed.

Note

Keep the lithium battery out of the children.
If the battery is swallowed, consult a doctor immediately.

BATTERY REPLACEMENT

When the remote control operating distance becomes short, the battery may be weak. Replace it with a new battery.

BATTERY CAUTIONS

Incorrect use of a battery may cause leakage or an explosion. Be careful of the following items:

When replacing:

- Replace only with CR2025 battery.
- Replace the battery in the correct (+) and (-) polarities as indicated in the battery holder.

Care of the remote control transmitter:

- When the remote control transmitter will not be used for an extended period of time, remove the battery.
- Replace weak battery early.

To prevent accidents:

- Never disassemble, heat, or throw a battery into a fire. Dispose of battery in specified places according to the regulation of your country if you have one.
- Never connect or short-circuit the (+) and (-) terminals directly with a metal piece, wire, etc.

OPERATION RANGE

The remote control transmitter should be facing toward the receiver and be within 7 meters (23 feet) and 30 degrees perpendicular of the receiver for proper operation.

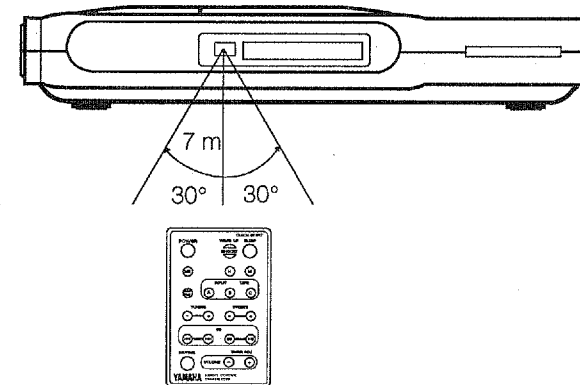

CONTROLS AND THEIR FUNCTIONS

(See Fig. 7.)

① POWER

Press to turn the power of this unit ON and OFF.

When the power is on, the color of the display turns orange and when the power is off, the color of the display turns green.

② WAKE UP (SNOOZE)

Press to set the wake-up timer to the desired time or cancel the wake-up timer setting.

③ SLEEP (CLOCK START)

Press to set or cancel the sleep timer and to start the current time display

④ Time controls

These are used to set the current time or the desired wake-up time.

HOURL

Press to set the hour of the current time or the desired wake-up time using the VOLUME/TIMER ADJ - and +.

MIN

Press to set the minute of the current time or the desired wake-up time using the VOLUME/TIMER ADJ - and +.

⑤ INPUT

Press these to select the corresponding input source (A or B).

⑥ TAPE (C)

Press this button to select the tape deck connected to this unit.

⑦ PRESET -/+

These are used to select the desired broadcast station preset of this unit.

Up to 19 broadcast station preset can be stored using PRESET -/+.

-: Press to call the desired broadcast station preset. Each time this is pressed, the preset number is decreased by one. (Ex: P8 → P7)

+: Press to call the desired broadcast station preset. Each time this is pressed, the preset number is increased by one. (Ex: P16 → P17)

⑧ CD controls

PLAY/PAUSE (▶/⏸)

Press this button to start playback.

When this button is pressed during playback, disc play is stopped temporarily.

STOP (□)

Press to stop playback.

SKIP/SEARCH (◀◀/▶▶)

Press ◀◀ or ▶▶ to skip to the desired track. (The skip function)

During playback, press and hold ▶▶ to play the disc in forward at high speed, press and hold ◀◀ to play the disc in reverse at high speed. (The search function)

⑨ VOLUME/TIMER ADJ control

Press to adjust the volume level heard from the speakers or headphones connected to this unit. When VOLUME/TIMER ADJ - or + is pressed, the volume level appears on the display (0 ~ 80) for about 5 seconds and then returns to the current time.

-: Press to decrease the volume.

+: Press to increase the volume.

⑩ MEMORY/ME

Press to set or cancel the preset station function in the tuner mode and the program play function in the CD mode.

⑪ AM/FM

Press to select the reception band between FM and AM.

⑫ TUNING -/+

Press to conduct auto tuning or manual tuning.

⑬ MUTING

Press to mute the volume. Press once again to cancel muting.

In the muting mode, the last volume level blinks.

Note

In this mode, other buttons or keys except MUTING and POWER do not function. When operating other function, press MUTING to cancel the muting mode.

⑭ OPEN (△)

Press to open the disc lid.

⑮ DISPLAY

Press this button to change the display mode for 5 seconds. The current time is usually displayed.

⑯ ◀/RESUME

Every time this button is pressed, the CD play mode is changed in the following order: NORMAL → REPEAT → RESUME → RESUME + REPEAT → NORMAL.

⑰ Remote control sensor

⑱ Display window

⑲ Remote control transmitter slot

⑳ BASS EXTENSION switch

The BASS BOOST ON/OFF switch at the rear is used to activate a circuit which effectively extends the low frequency output.

CURRENT TIME SETTING

- The current time setting can be operated with the remote control transmitter.
 - The current time can be set even when the power is off.
1. Press the HOUR key on the remote control transmitter to set the hour of the current time. While the hour blinks, use VOLUME/TIMER ADJ – or + to decrease or increase the hour.
 2. Once the hour is set, press the MIN key on the remote control transmitter to set the minute of the current time. While the minute blinks, use VOLUME/TIMER ADJ – or + to decrease or increase the minute.
 3. Once the hour and minute are adjusted to the current time, press the SLEEP (CLOCK START) key on the remote control transmitter to start the current time display.
- If the time display is blinking after a power failure or the AC cord is disconnected, repeat the above procedure.

OPERATION

LISTENING TO RADIO

■ AUTO TUNING

If signals are strong and there is no interference, quick automatic search tuning is possible.

1. Press POWER to turn on the unit and the color of display changes from green to orange.
2. Select the reception band with the AM/FM key on the remote control transmitter.
3. Press the TUNING – or + key on the remote control transmitter for more than 0.5 seconds. Tuning will start automatically and will stop at the broadcast station frequency with a sufficient signal strength.
4. If the station where tuning stops is not the one you desire, keep pressing the TUNING – or + key once again.
5. Adjust the volume with VOLUME/TIMER ADJ – or +.

■ MANUAL TUNING

Auto tuning may not stop if the station signal is weak. In this case, use manual tuning.

1. Select the reception band with the AM/FM key.
2. Press the TUNING – or + key on the remote control transmitter. Each time the TUNING – or + key is pressed, the frequency changes.
3. Adjust the volume with VOLUME/TIMER ADJ – or +.

■ PRESET TUNING

The Preset Station can be used to select any desired station which has been preset.

Up to 19 stations can be stored.

Presetting station

1. Tune to the desired station using the auto or manual tuning.
 2. Press the ME key on the remote control transmitter. The MEMORY indicator blinks for approximately 5 seconds.
 3. While the MEMORY indicator blinks, select the desired preset station number (P1 - P19) using the PRESET – or + key on the remote control transmitter.
 4. Once the desired preset station is chosen, press the ME key on the remote control transmitter once again to set the preset station.
- The step 3 and 4 should be performed while the MEMORY indicator blinks.
 - Follow the same procedure for the remaining Preset Station. The new setting will be stored in place of the former one.

Selecting the presetting station

1. Press PRESET –/+ so that the desired frequency and program number appear on the display. The frequency display changes to the current time display after approximately 5 seconds.
2. Adjust the volume with VOLUME/TIMER ADJ – or +.

Memory back-up

The stored stations are maintained for approximately one day even if the AC cord is disconnected from the AC outlet. If they are erased, store the stations by simply following the above procedure. Power must be supplied for at least 72 hours before full back up facility is operative.

Playing a CD

■ Loading a CD

1. Press POWER to turn on the unit and the color of display changes from green to orange.
2. Press the OPEN button to open the disc lid.
3. Place a compact disc on the disc tray with the label side up fitting the center hole to the axis of the disc tray. (A 3-inch CD can be also used.)
4. Push the left side of the disc lid (marked with CLOSE ▼) to close it. When the disc is loaded, the total play time and the total track number are indicated on the display.

- A compact disc is played the only one side.
- Place only one compact disc on the disc tray.
- Do not use an commercially available disc stabilizer. This could result in a malfunction.

■ Normal play

Playback starts from the beginning of a disc.

1. Press ▷/⏮ to start playback. When playback begins, the elapsed time of the first track appears for a few seconds and returns to the current time.
 2. Adjust the volume with VOLUME/TIMER ADJ – or + .
- When playback is completed, the unit stops at the beginning of the disc.

To stop playback temporarily

Press ▷/⏮. The current track number blinks.

To resume playback, press ▷/⏮ again.

To stop playback completely

Press □.

To check the elapsed time

Press the DISPLAY button on the unit. The elapsed time of the track being played is displayed for about 5 seconds and then the display returns to the current time and current track number.

To check the total track number/play time of a disc

1. Press ▷/⏮.
 2. Press □ to stop playback.
- The total track number and the total play time are displayed for about 5 seconds and then the display changes to the current time and total track number. Even after the display changes to the current time, the total track number and the total play time are displayed by pressing the DISPLAY button.

Notes

- When a CD is played, the sound or picture of the tuner or TV located near this unit may be noisy or fluctuate. Because this is likely to happen especially to the tuner or TV connected to an indoor antenna, it is recommended to use an outdoor antenna.
- If the unit is given a shock or used in an unstable place, the sound will skip during playback.
- When you remove a disc during playback, press □ and then the OPEN button after checking the disc completely stops. Do not press the OPEN button during rotating a disc. This could damage a disc.

■ Skip play

This function allows you to play a desired track.

To listen to the track following the one presently playing:

Press ▷/⏮ in succession.

To listen to the presently playing track once again

Press ◀◀ once.

To listen to the track previous to the one presently playing

Press the ◀◀ in succession.

- When ◀◀ or ▷/⏮ is pressed in the play mode, play will begin automatically at the selected track.
- When ◀◀ or ▷/⏮ is pressed in the stop or pause mode, press ▷/⏮ to start playback.

■ Manual search

This function allows you to locate the desired part during playback.

To go back at high speed

Keep pressing ◀◀. When you have found the desired part, release ◀◀ and normal play will begin from that point.

To go ahead at high speed

Keep pressing ▷/⏮. When you have found the desired part, release ▷/⏮ and normal play will begin from that point.

■ Program play

This function allows you to program up to 24 tracks (up to 120 minutes of total play time) in the desired order.

* This function cannot be performed in the tuner mode.

1. Press \square to set the unit into stop mode.
2. Press the MEMORY button or the ME key on the remote control transmitter. The MEMORY indicator blinks.

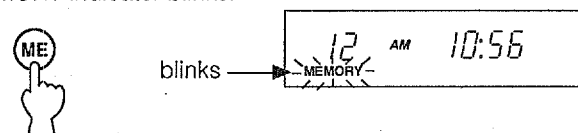

3. Select the desired track to be played first with \lll or \ggg .

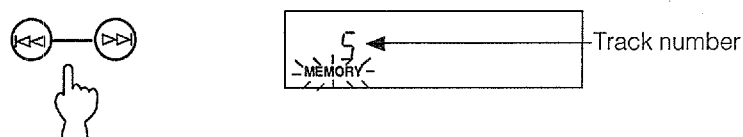

4. Press the MEMORY button or the ME key to set the program. The program number is displayed. The display changes from the program number to the total play time of a programmed track 2 seconds later.

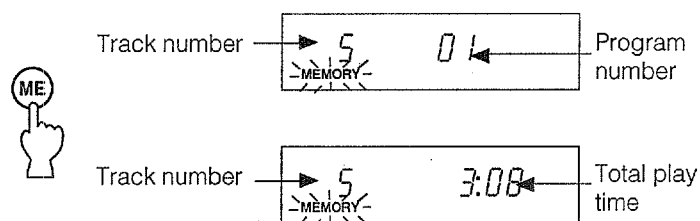

5. Repeat the step 3 and 4 above to program the desired tracks.
6. When the last track has been programmed, press \square . The number of programmed tracks and the total play time are indicated on the display.

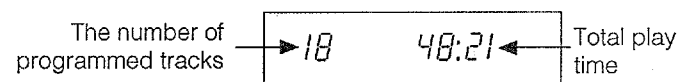

7. Press $\triangleright/\text{III}$ to start a program play.
 - When a program play is completed, the unit enters stop mode.
 - You can program the same track more than one time.
 - With the CD which contains 24 tracks or more, the total play time is not displayed.

- A program is maintained as long as the disc lid is closed even if the power is turned off.
- A program can be played with the repeat or resume function.

To cancel a programmed track

1. Press \square .
 2. Press \lll or \ggg so that the track number to be canceled appears on the display. (The track number to be cancelled blinks.)
 3. Press the MEMORY button or the ME key on the remote control transmitter.
 4. Repeat the step 2 and 3 above to cancel a programmed track.
 5. To stop cancelling a program, press \square .
- While programming, the selected track cannot be canceled.

To cancel all program contents

1. Press \square .
2. Press the OPEN button to open the disc lid. All program contents are cancelled.

■ Repeat play

This function allows you to repeat all tracks of a disc or a program.

To repeat all tracks of a disc

1. Press the \curvearrowright /RESUME button so that the \curvearrowright indicator is displayed.
 - When the unit is in stop mode or pause mode, press $\triangleright/\text{III}$ to start playback.

To repeat a program play

1. Program the desired tracks in the desired order.
2. Press the \curvearrowright /RESUME button so that the \curvearrowright indicator is displayed.
 - When the unit is in stop mode or pause mode, press $\triangleright/\text{III}$ to start playback.

To cancel a repeat play

Press the \curvearrowright /RESUME button so that the \curvearrowright indicator disappears from the display window.

■ Resume play

Once the resume play mode is selected, the unit starts playback from the previously played track when the unit is turned on or returns to the CD mode. Press the \curvearrowright /RESUME button so that the RESUME indicator is displayed.

- If the OPEN button is pressed to open the disc lid, playback starts from the first track.
- When the last track is completed, the unit enters the stop mode automatically.

Resume repeat play

To enter the resume repeat play, press the \curvearrowright /RESUME button so that the \curvearrowright and RESUME indicators are displayed.

Once the resume repeat play mode is selected, resume playback starts when the unit is turned on or returns to the CD mode. When the resume play is completed, all tracks of a disc or a program will be played repeatedly.

TIMER OPERATION

- Set the current time before performing the WAKE-UP TIMER or SLEEP TIMER functions.

WAKE-UP TIMER

At the preset time, the wake-up timer function will turn on this unit.

- The wake-up timer setting can be operated with the remote control transmitter.
- The wake-up timer can be set even when the power is off.
- When you select the source connected to the A, B or C jack, use the equipment with the timer function.
- **If any key is not pressed for more than about 8 seconds in steps 1, 3 and 4, the display changes to the following one. So decide the program source and the volume level in advance.**
- The setting of the wake-up timer function is performed in the following procedure: 1. Display the WAKE-UP indicator. → 2. Set the wake-up time. → 3. Select the source. → 4. Adjust the volume.

- To enter the wake-up timer setting mode.

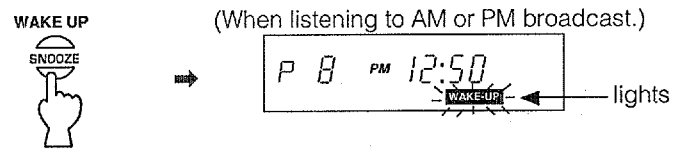

- Set the hour of the desired wake-up time.

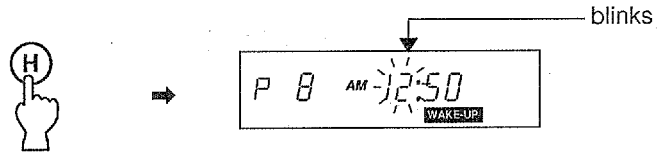

- While the hour is blinking, press VOLUME/TIMER ADJ - or +.

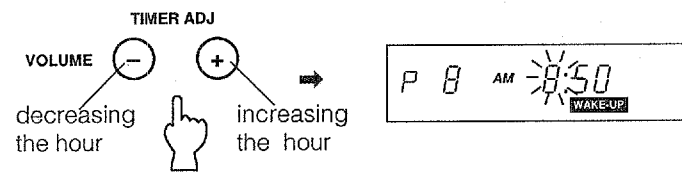

- Set the minute of the desired wake-up time.

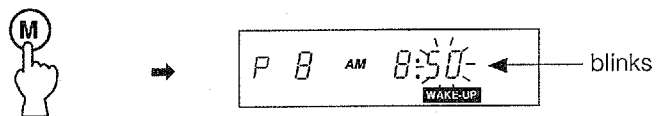

- While the minute is blinking, press VOLUME/TIMER ADJ - or +.

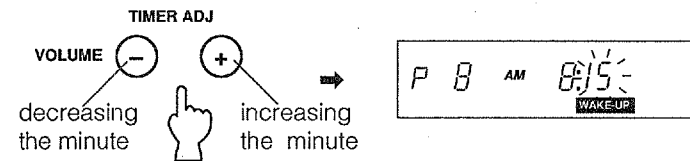

- To enter the source mode.



- Select the desired source.

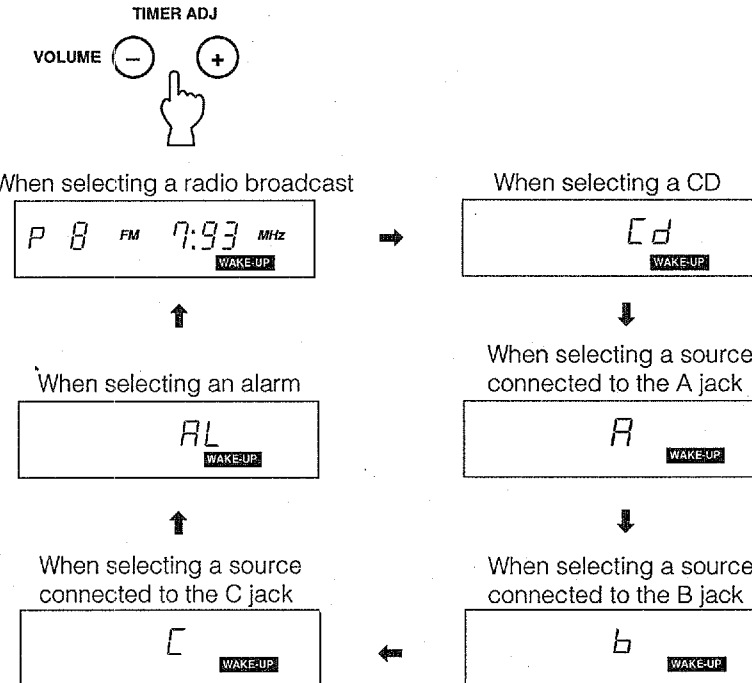

- In case of selecting the radio broadcast, the preset station can be selected with PRESET -/+.

5. To enter the volume mode.

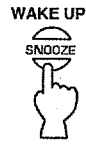

6. Adjust the volume level. (0 ~ -80)

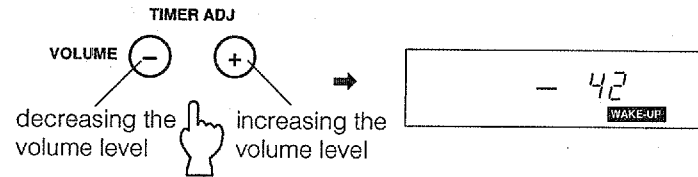

7. Complete the wake-up timer setting.



- If the power is on, press POWER to turn off the unit.

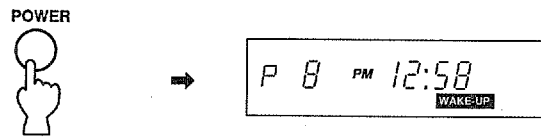

- If any button or key on the remote control is not pressed in the steps above, each of the display except that of the wake-up time setting changes in 8 seconds.
- If WAKE UP (SNOOZE) is pressed while the alarm is generated, the alarm stops and then sounds again 5 minutes later (Snooze mode). The snooze mode continues for approximately 60 minutes as long as the alarm is stopped with WAKE UP (SNOOZE). In the snooze mode, the time display blinks.
- After the power is turned on by the wake-up timer function, the unit is turned off in approximately 130 minutes when CD, radio broadcast, or source connected to the A, B or C jack is selected and in approximately 60 minutes when the alarm is selected. (In case of changing the source during the wake-up timer mode, the unit will not be turned off automatically.)
- To stop the alarm, radio broadcast, or play of the selected source after the wake-up time is reached, press POWER.

To cancel the wake-up timer mode

Press WAKE UP (SNOOZE) so that the WAKE-UP indicator disappears. The wake-up timer mode will function as long as the mode is not cancelled.

To check the setting of the wake-up timer mode

After pressing WAKE UP (SNOOZE) to make the WAKE UP indicator disappear, press WAKE UP (SNOOZE) again.

Each time the WAKE UP (SNOOZE) button is pressed, the setting time of the wake-up timer, selected source and the volume level as well as the WAKE UP indicators are displayed in sequence.

- If you check the alarm volume when the power is off, you can monitor the alarm sound.

■ SLEEP TIMER

This function is convenient to listen to CD or the radio broadcast in a bed.

To set the sleep timer

When the POWER of this unit is on, press SLEEP. The SLEEP indicator is displayed and the unit will be off one hour later.

To cancel the sleep timer

Turn off the unit or press SLEEP again and the SLEEP indicator disappears.

NOTES

- Both the sleep timer and the wake-up timer functions can be set. For example, you can use the sleep timer function at night and wake up with the wake-up timer function.

To operate with other audio equipment

Playing back other sources

1. Turn on the power of both this unit and the connected other audio equipment.
 2. Select the audio equipment (A, B or C) with the INPUT button.
 3. Set the selected audio equipment to playback mode.
 4. Adjust the volume level with VOLUME/TIMER ADJ - or +.
- Set the volume control of the connected equipment to the same level as radio broadcast beforehand.

Recording with cassette recorder

By connecting the TAPE OUT Jack of this unit to the LINE IN or MIC jack of a cassette deck with optionally available stereo mini-plug cable, you can record the sound of this unit.

NOTES ON HANDLING DISC

- Your unit has been specifically designed for the reproduction of compact discs bearing the "CD" mark. No other discs should be loaded into the player.
- To remove a disc from its storage case, press down on the center of the opened case and lift the disc out carefully, holding it by the edges.

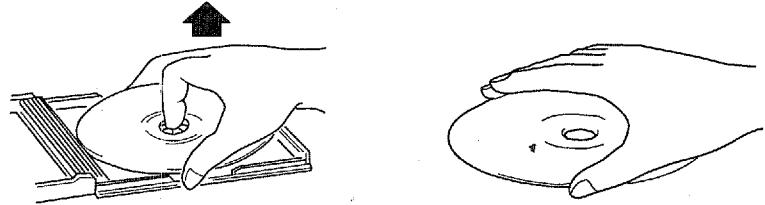

- Although compact discs are impervious to wear during play, damage to surface of a disc through improper handling will result in play irregularities.
- Although minute dust particles and finger prints should have no effect on play, you should keep the recorded side surface of your discs clean by wiping them with a clean, dry cloth. Wipe in a straight motion from the inside to the outside. Do not wipe in a circular motion.

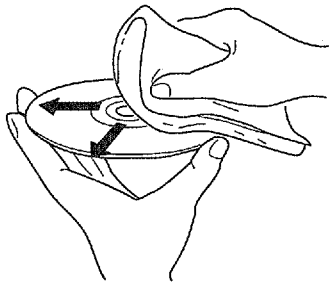

- Never use record cleaner, record spray, antistatic sprays or liquids, or any chemical-based liquid to clean the surface of a disc as these may irreparably damage the disc's plastic case.
- Avoid exposing discs to direct sunlight, high temperature, or high humidity for extended periods of time. Long exposure to high temperatures may warp a disc.



- Carefully handle the compact disc so that its surface is not scratched.

TROUBLESHOOTING

If the unit fails to function properly, check the following points to determine whether the problem can be corrected by the simple measures suggested. If it cannot, or if the problem is not listed in the SYMPTOM column, disconnect the unit's power cord and contact your YAMAHA dealer or service center for assistance.

SYMPTOM	POSSIBLE CAUSE	REMEDY
The unit fails to turn on when POWER is pressed.	The power cord is not connected or not completely.	<ul style="list-style-type: none"> ● Securely connect the power cord.
No sound.	The speaker connection is incorrect.	<ul style="list-style-type: none"> ● Securely connect the speaker cords.
	The VOLUME/TIMER ADJ is not set to the proper level.	<ul style="list-style-type: none"> ● Press VOLUME/TIMER ADJ to adjust the sound level.
	The setting of the INPUT button is incorrect.	<ul style="list-style-type: none"> ● Set the INPUT button properly.
No sound. Other buttons or keys except MUTING and POWER cannot be operated.	MUTING is pressed.	<ul style="list-style-type: none"> ● Press MUTING to cancel the muting mode.
Broadcast cannot be received.	Insufficient antenna input.	<ul style="list-style-type: none"> ● Tighten the an antenna and rotate it for best reception. ● Use the external FM antenna.
In the FM mode, crackling sounds from time to time (especially in weak signal areas).	Ignition noise from passing vehicles.	<ul style="list-style-type: none"> ● Tighten the an antenna and rotate it for best reception. ● The FM outdoor antenna should be put up as high as possible, away from the road, and a coaxial cable used.
	Noise from other electrical equipment with thermostats.	
Preset tuning cannot be carried out.	The preset memory is erased.	<ul style="list-style-type: none"> ● Repeat the presetting procedure.
In the AM mode, there are continuous crackling and hiss noises.	These noises results from lightning, fluorescent lamps, motors, thermostats and other electrical equipment.	<ul style="list-style-type: none"> ● Tighten the an antenna and rotate it for best reception. ● Use an outdoor antenna and a ground wire. This will help somewhat but it is difficult to eliminate all noise.
	The unit is used near a TV, computer and so on.	<ul style="list-style-type: none"> ● Use the unit apart from a TV, computer and so on.
Disc play does not start.	The disc has been loaded upside down.	<ul style="list-style-type: none"> ● Reload the disc with the label side up.
	The disc is dirty.	<ul style="list-style-type: none"> ● Clean the disc.
Sound skips (at the same part).	The disc is dirty.	<ul style="list-style-type: none"> ● Clean the disc.
	The sound level is so high as to cause the vibration to the speakers.	<ul style="list-style-type: none"> ● Press VOLUME/TIMER ADJ to adjust the sound level.
The wake-up timer does not function.	The wake-up timer is not set.	<ul style="list-style-type: none"> ● Press WAKE UP (SNOOZE) to display the WAKE UP indicator.
	The current time is not correct.	<ul style="list-style-type: none"> ● Set the current time correctly.
The remote control transmitter cannot be operated.	The batteries are exhausted.	<ul style="list-style-type: none"> ● Replace batteries.
	The remote control transmitter is operated from an incorrect distance or angle.	<ul style="list-style-type: none"> ● Operate it from less than 7 meters (about 20 ft.) and 30°.
	The remote control sensor is lighted strongly.	<ul style="list-style-type: none"> ● Place the unit away from the strong light.

YAMAHA

YAMAHA ELECTRONICS CORPORATION, USA 6722 ORANGETHORPE AVE., BUENA PARK, CALIF. 90620, U.S.A.
YAMAHA CANADA MUSIC LTD. 135 MILNER AVE., SCARBOROUGH, ONTARIO M1S 3R1, CANADA
YAMAHA ELECTRONIK EUROPA G.m.b.H. SIEMENSSTR. 22-34, D-2084 RELINGEN BEI HAMBURG F.R. OF GERMANY
YAMAHA ELECTRONIQUE FRANCE S.A. 17 RUE DES CAMPANULES, LOGNES 77321 MARNE LA VALLEE CEDEX 2 FRANCE
YAMAHA ELECTRONICS (UK) LTD. YAMAHA HOUSE, 200 RICKMANSWORTH ROAD WATFORD, HERTS WD1 7JS, ENGLAND
YAMAHA SCANDINAVIA A.B. J A WETTERGRENS GATA 1, BOX 30053, 400 43 VASTRA FRÖLUNDA, SWEDEN
YAMAHA MUSIC AUSTRALIA PTY, LTD. 17-33 MARKET ST., SOUTH MELBOURNE, 3205 VIC., AUSTRALIA

YAMAHA CORPORATION

VK38510-0 BWWB,g Printed in Japan ©

A. 12
B. 12

1 2