

YAMAHA

EM-202VCD

VIDEO CD CHANGER RECEIVER

小影碟转换器接收机

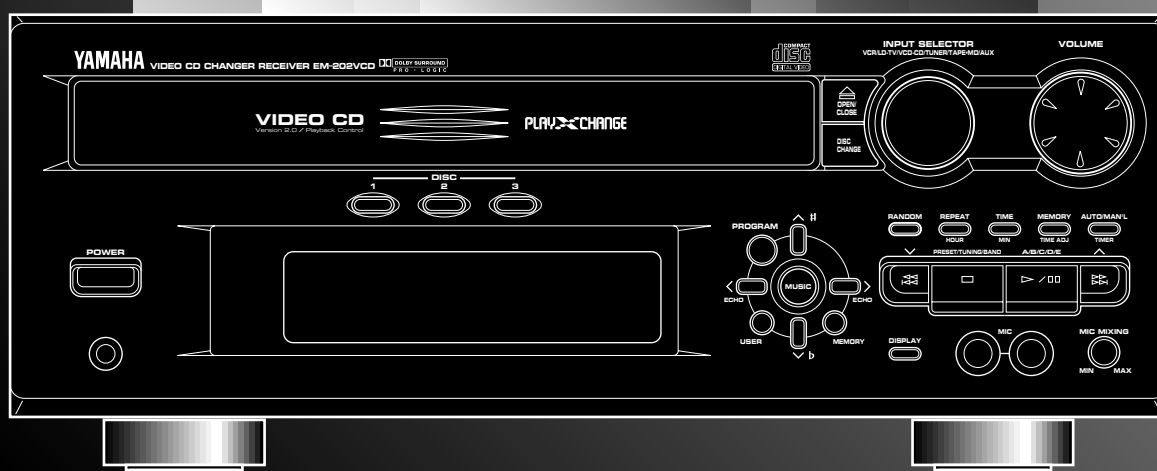

OWNER'S MANUAL

使用说明书

SUPPLIED ACCESSORIES

- After unpacking, check that the following parts are contained.

- Remote control transmitter
- 遥控器

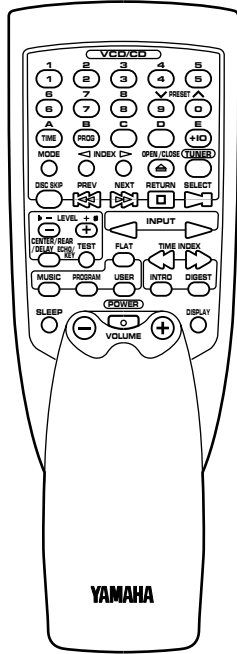

- AM loop antenna
- AM 环形天线

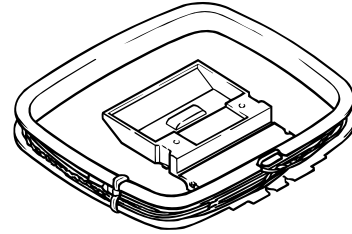

- Indoor FM antenna
- 室内 FM 天线

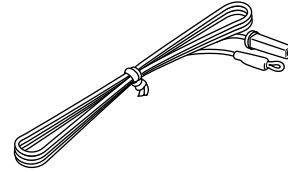

- Batteries (size AA, UM/SUM-3, R6, HP-7)
- 电池 (尺寸: AA, UM/SUM-R6, HP-7)

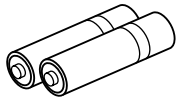

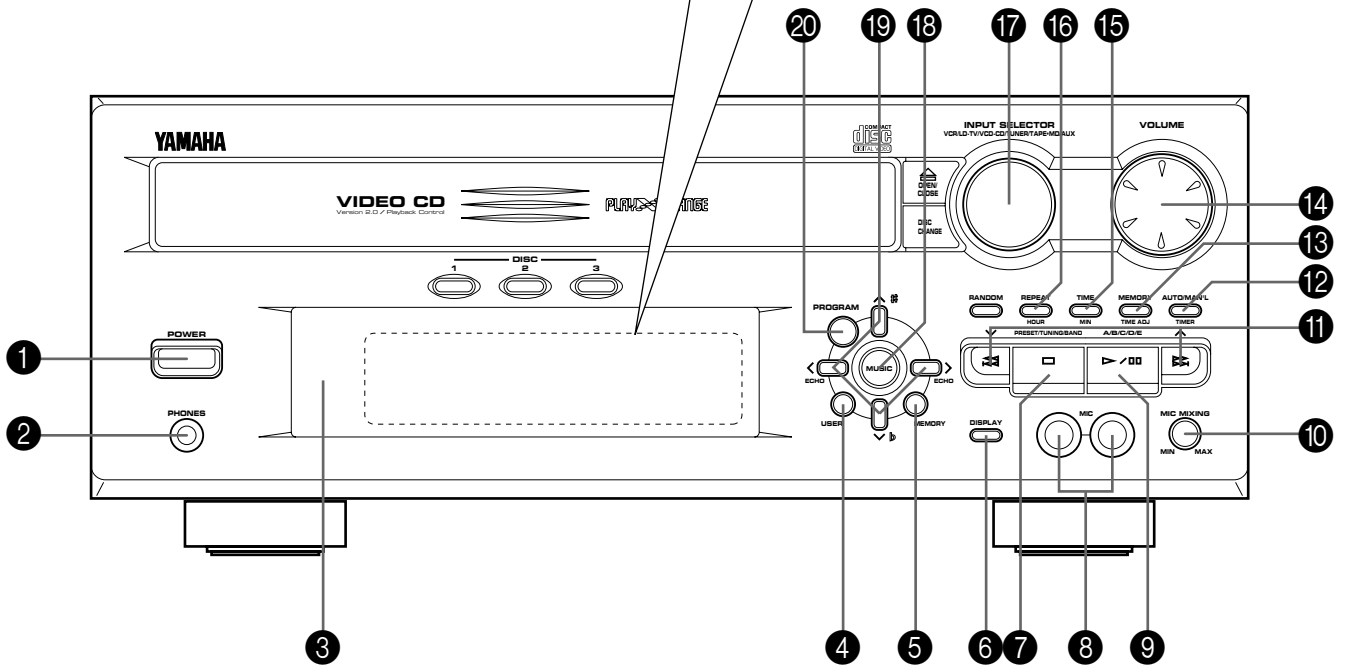
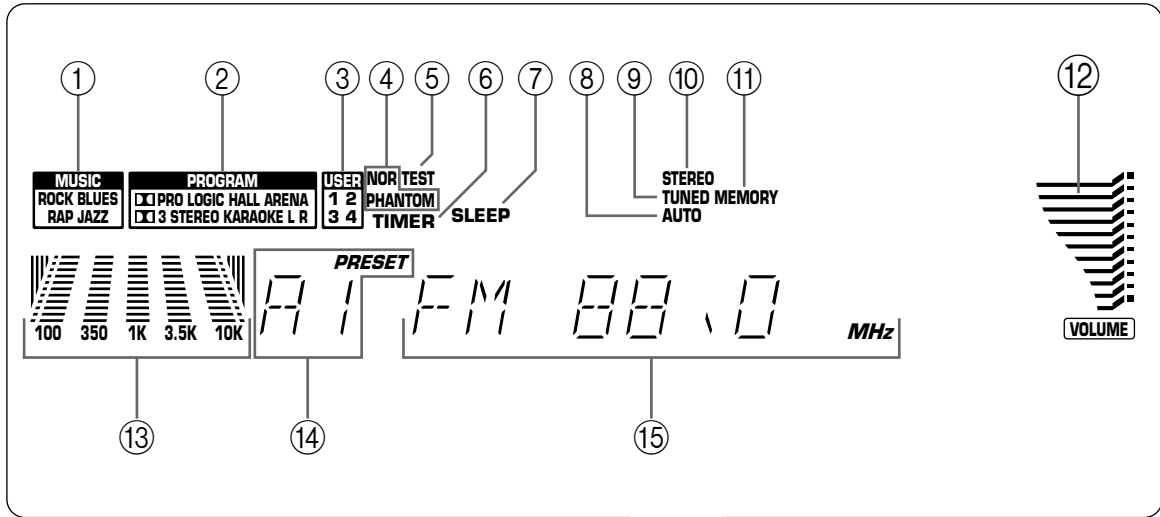

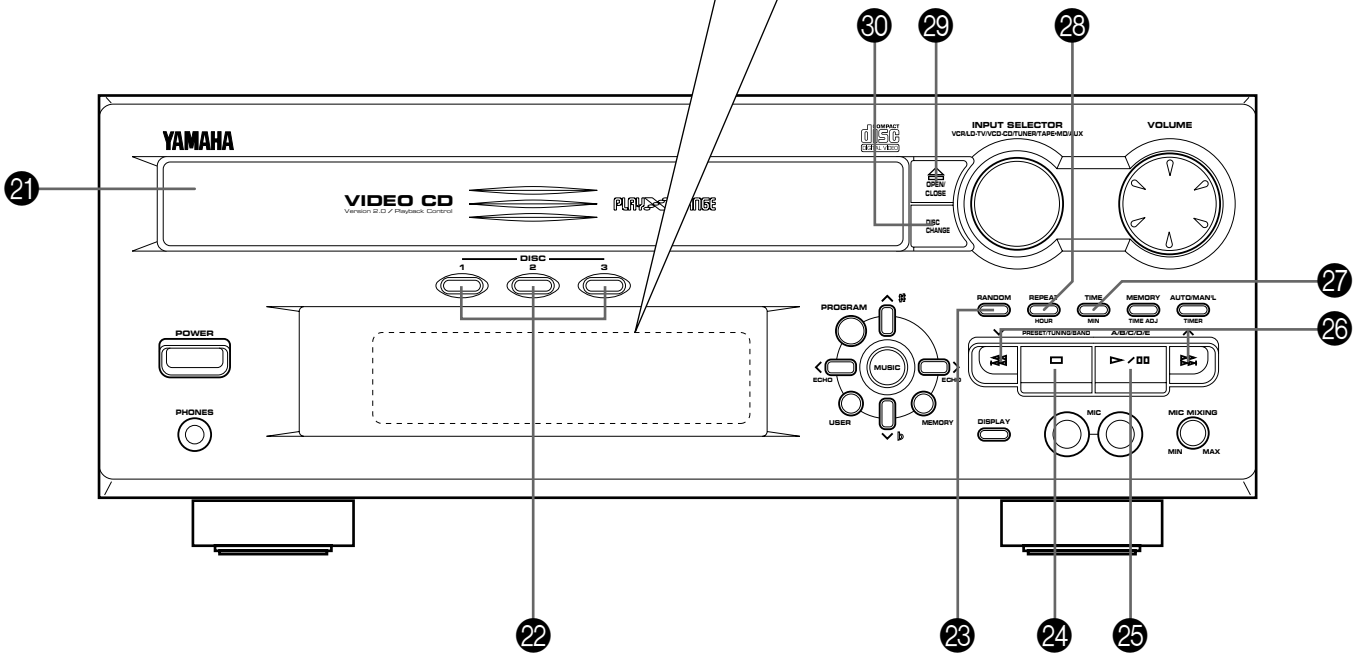
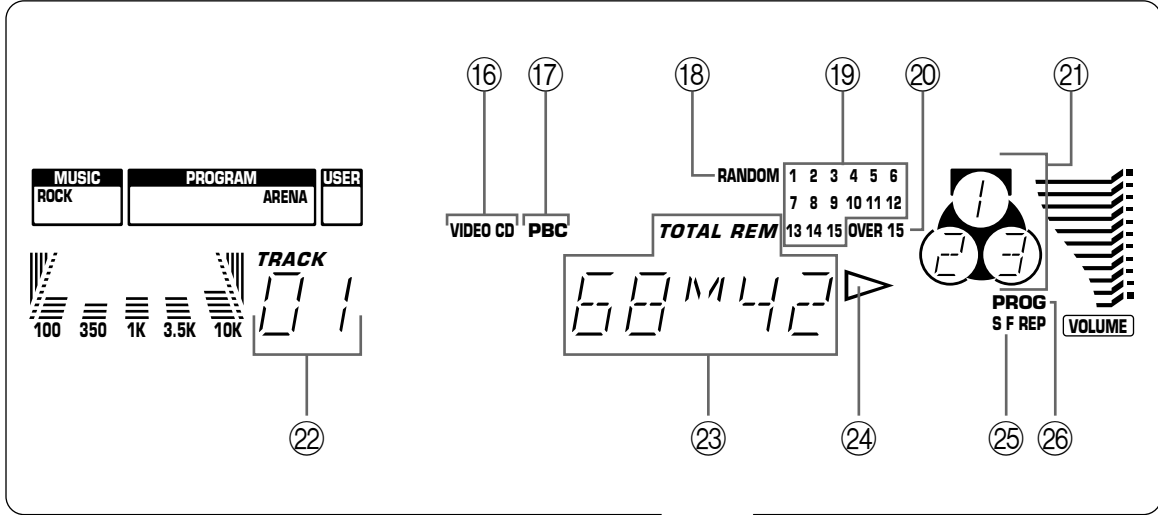

3

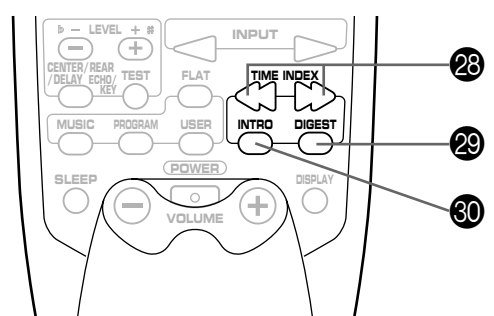
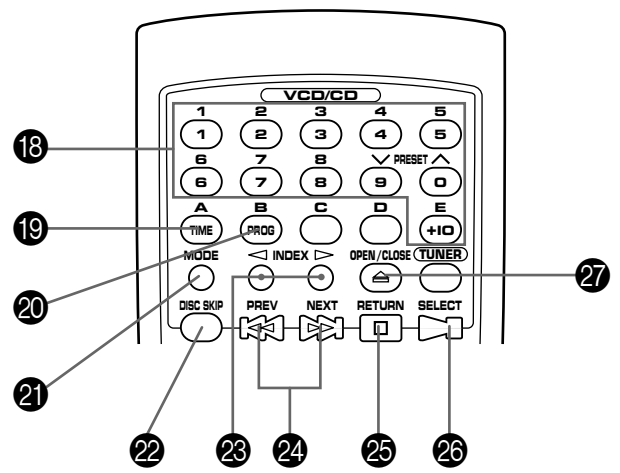
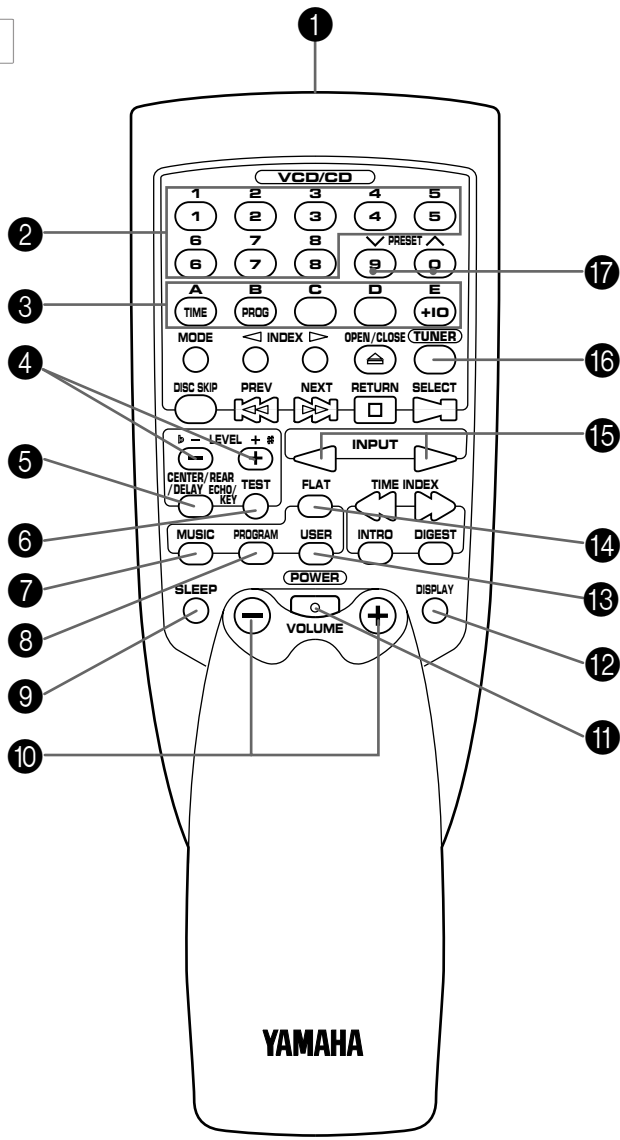

4

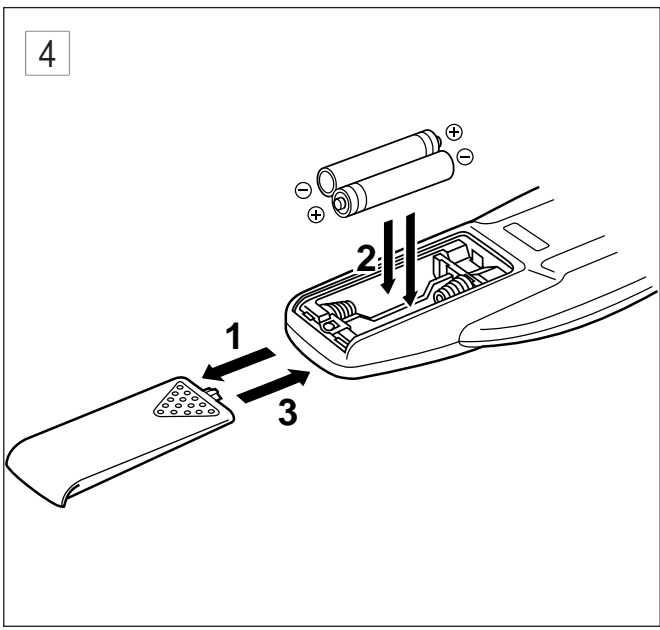

5

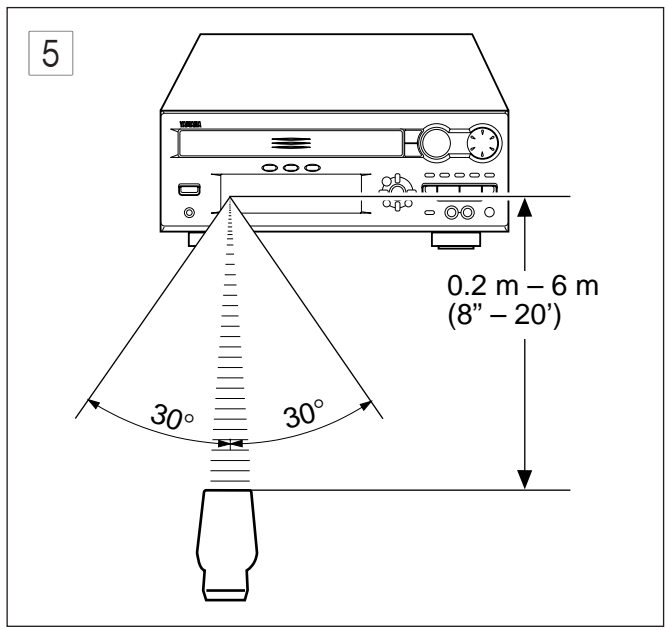

Rear speakers
后置扬声器

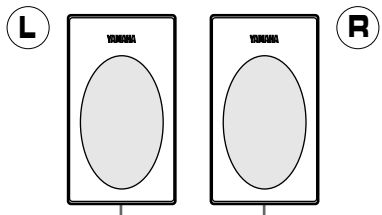

Center speaker
中置扬声器

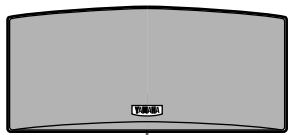

Front speakers
前置扬声器

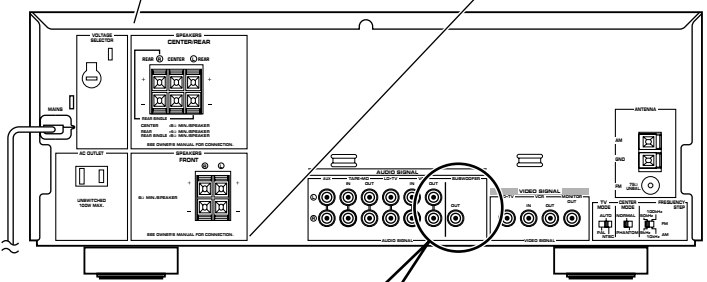
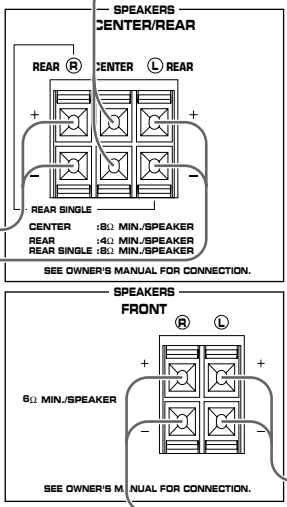
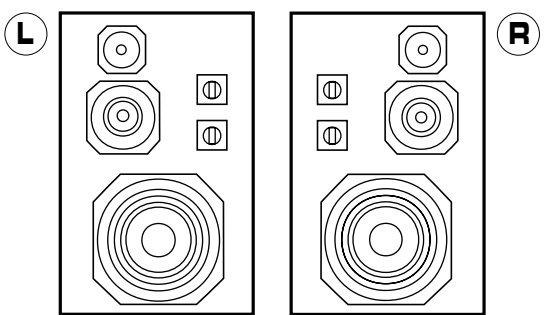

Subwoofer
超低音扬声器系统

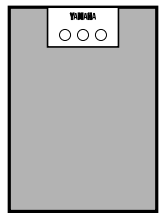
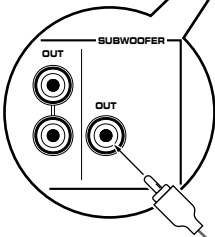

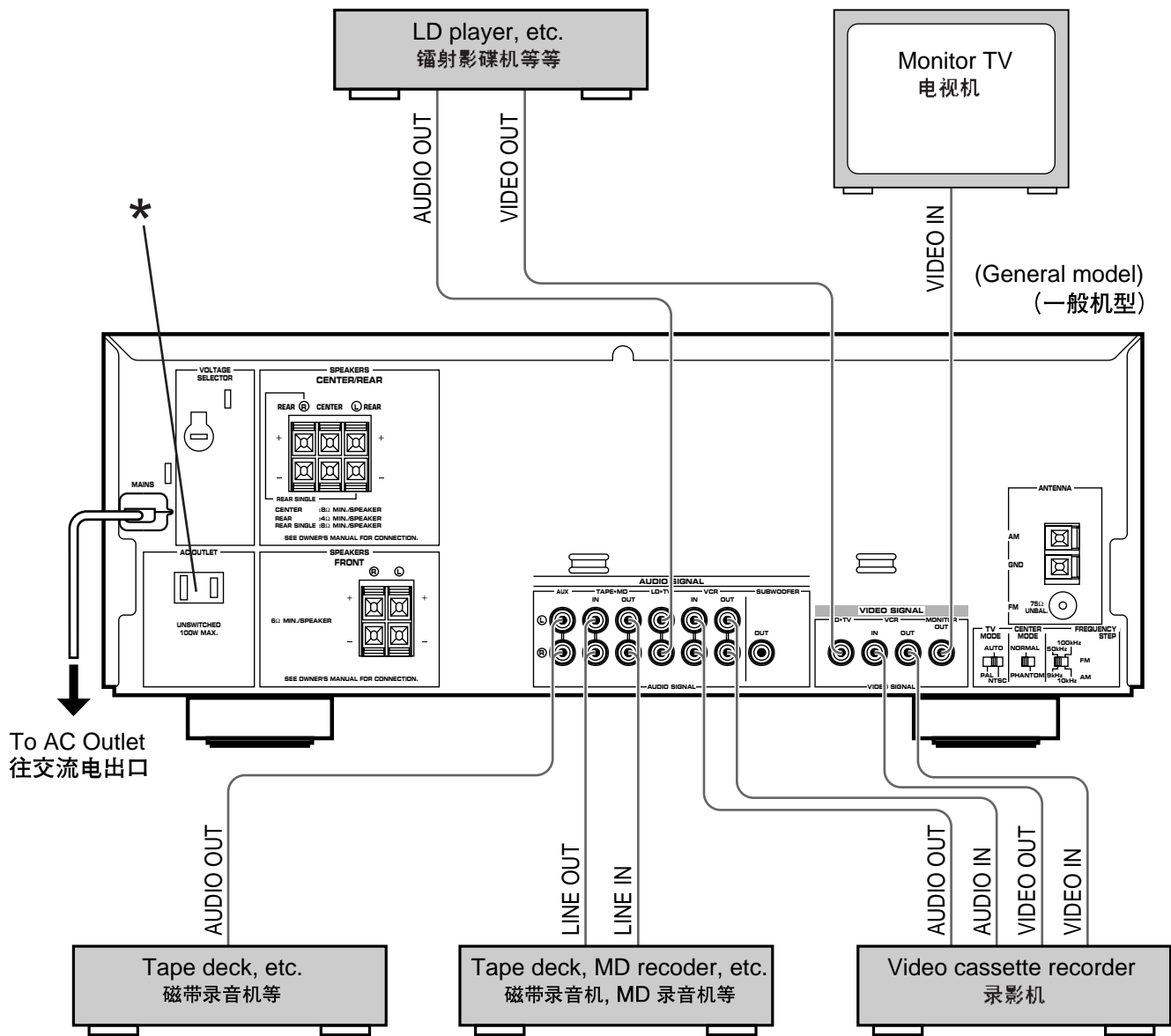

8

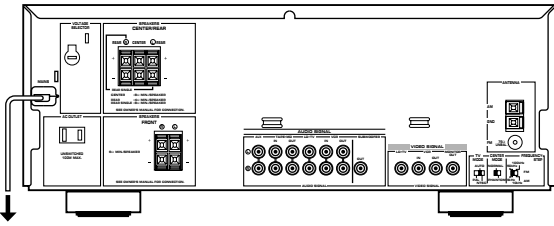

To AC Outlet
往交流电出口

9

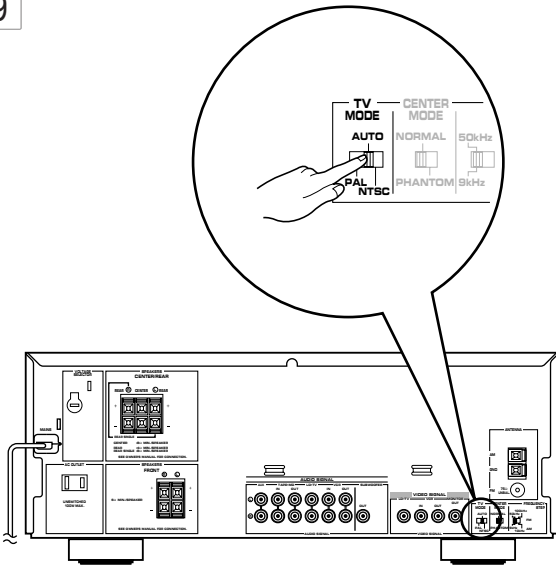

10

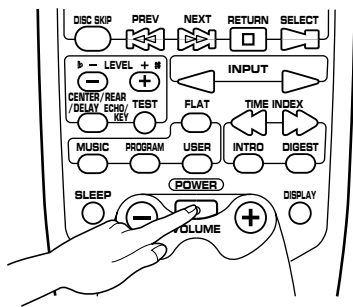
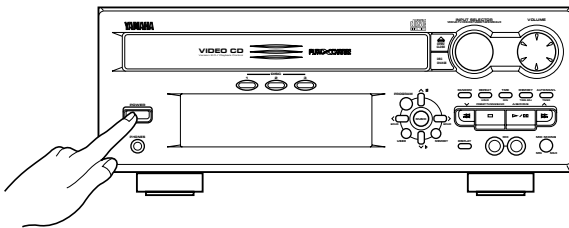

11

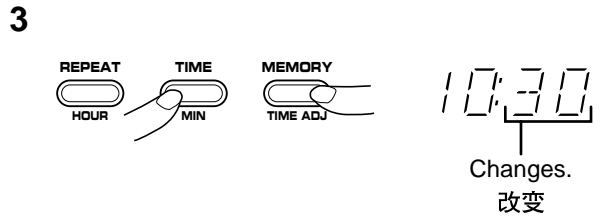
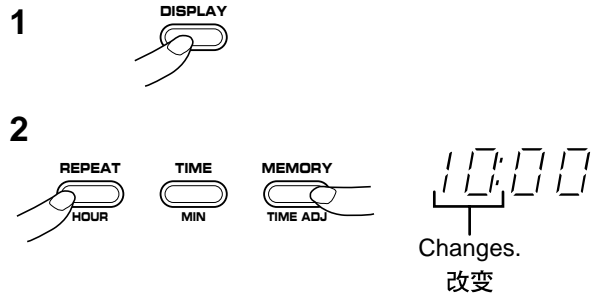

12

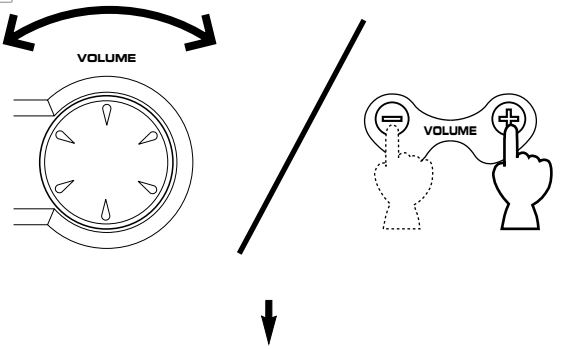

VOL 25



13

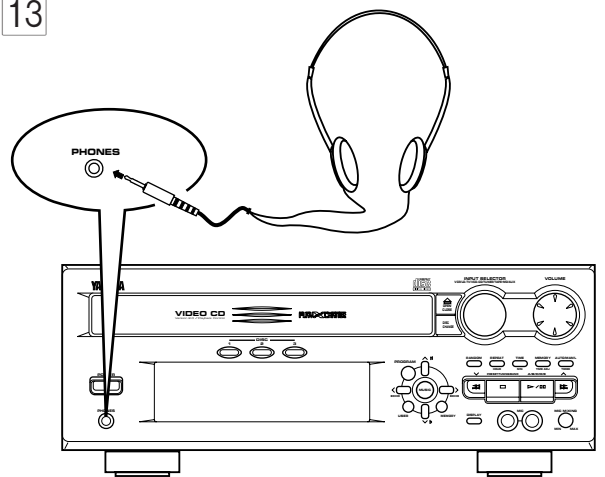

ENGLISH

INTRODUCTION

Thank you for purchasing this YAMAHA product. We hope it will give you many years of trouble-free enjoyment. For the best performance, read this manual carefully. It will guide you in operating your YAMAHA product.

CONTENTS

	Page		Page
PRECAUTIONS.....	2-3	CARE OF VIDEO CDS (CDS)	11
FEATURES	4	SPEAKER BALANCE ADJUSTMENT	12-13
NAMES OF CONTROLS AND INDICATORS	5	VIDEO CD PLAYER OPERATION	14-21
REMOTE CONTROL TRANSMITTER	6	PLAYBACK CONTROL OF VIDEO CD (Ver. 2.0)	22-24
SETTING UP THE SPEAKERS.....	7	TUNING OPERATION	25-27
CONNECTIONS	8-9	OPERATING EXTERNAL UNITS CONNECTED WITH THIS UNIT.....	28
SETTING THE VIDEO OUTPUT FORMAT SELECTOR (TV MODE) SWITCH.....	10	USING GRAPHIC EQUALIZER	29-30
TURNING THE POWER TO THIS UNIT ON OR IN THE STANDBY MODE.....	10	USING SOUND FIELD PROCESSOR	31-34
SETTING THE CLOCK.....	10	STORING YOUR OWN PROGRAMS	35
ADJUSTING BRIGHTNESS OF THE DISPLAY	11	KARAOKE OPERATION	36-37
VOLUME CONTROL	11	HOW TO USE THE BUILT-IN TIMER	38-40
LISTENING WITH HEADPHONES.....	11	TROUBLESHOOTING.....	41
		SPECIFICATIONS	42

For basic source play, the following illustrations on top of pages will help you to look for the section you need.



.....Video CD (CD) playback



.....Tuning

PRECAUTIONS: READ THIS BEFORE OPERATING YOUR UNIT

- To assure the finest performance, please read this manual carefully. Keep it in a safe place for future reference.
- Choose the installation location of this unit carefully. Avoid placing it in direct sunlight or close to a source of heat. Also avoid locations subject to vibration and excessive dust, heat, cold or moisture. Keep it away from sources of hum such as transformers and electric motors.
- Do not operate this unit upside-down. It may overheat, possibly causing damage.
- Never open the cabinet. If something drops into the set, contact your dealer.
- The openings on the cabinet assure proper ventilation of the unit. If these openings are obstructed, the temperature inside the cabinet will rise rapidly. Therefore, avoid placing objects against these openings, and install the unit in well-ventilated condition. Make sure to allow a space of at least 20 cm behind, 20 cm on the both sides and 30 cm above the top panel of the unit. Otherwise it may not only damage the unit, but also cause fire.
- Always set the VOLUME control to minimum before starting an audio source play: increase the volume gradually to an appropriate level after play has started.
- When not planning to use this unit for long periods of time (ie., vacation, etc.), disconnect the AC power plug from the wall outlet.
- Grounding or polarization – Precautions should be taken so that the grounding or polarization of the unit is not defeated.
- Do not use force on switches, controls or connection wires. When moving the unit, first disconnect the power plug and the wires connected to other equipment. Never pull the wire itself.
- Do not attempt to clean the unit with chemical solvents; this might damage the finish. Use a clean, dry cloth.
- Be sure to read the “TROUBLESHOOTING” section regarding common operating errors before concluding that the unit is faulty.
- To prevent lightning damage, disconnect the AC power plug and the antenna cable when there is an electrical storm.
- Do not plug the AC power plug to the wall socket before you finish all connections.
- The voltage to be used must be the same as that specified on this unit. Using this unit with a higher voltage than that which is specified is dangerous and may result in a fire or other type of accident causing damage. YAMAHA will not be held responsible for any damage resulting from use of this unit with a voltage other than that which is specified.
- The sound level at a given volume setting depends on speaker location and other factors. Care should be taken to avoid exposure to sudden high levels of sound, which may occur when turning on the unit with the volume control setting at high, and to continuous high levels of sound.
- Sudden temperature changes and storage or operation in an extremely humid environment may cause condensation inside the cabinet. Condensation can cause the unit to malfunction. To eliminate condensation:
 - **Pickup**
Leave the power on with no disc in the unit until normal playback is possible (about 1 hour).
 - **Remote control**
Wipe off condensation on the transmitter window with a soft cloth before operating the unit.

IMPORTANT

Please record the serial number of this unit in the space below.

Serial No.:

The serial number is located on the rear of the unit. Retain this Owner's Manual in a safe place for future reference.

WARNING

TO REDUCE THE RISK OF FIRE OR ELECTRIC SHOCK, DO NOT EXPOSE THIS APPLIANCE TO RAIN OR MOISTURE.

PRECAUTIONS: READ THIS BEFORE OPERATING YOUR UNIT

NOTE

Please check the copyright laws in your country to record from records, compact discs, radio, etc. Recording of copyright material may infringe copyright laws.

CAUTION FOR CARRYING THIS UNIT

Be sure not to carry or tip this unit with discs remaining in it.

CAUTION FOR MOVING THIS UNIT

Before moving this unit, first remove all discs from the disc table and close the table by pressing the OPEN/CLOSE button. After you confirm that "NO DISC" lights up on the display, switch off the power by pressing the POWER switch, and then disconnect the power plug from the AC outlet.

This unit is not disconnected from the AC power source as long as it is connected to the wall outlet, even if this unit itself is turned off. In this state, this unit is designed to consume a very small quantity of power.

VOLTAGE SELECTOR (General model only)

The voltage selector on the rear panel of this unit must be set for your local main voltage BEFORE plugging into the AC main supply.

Voltages are 110/120/220/240V AC, 50/60 Hz.

WARNING

To reduce the risk of fire or electric shock, do not expose this unit to rain or moisture.

To avoid electrical shock, do not open the cabinet. Refer servicing to qualified personnel only.

CAUTION 1

Use of controls or adjustments or performance of procedures other than those specified herein may result in hazardous radiation exposure.

CAUTION 2

As the laser beam used in this unit is harmful to the eyes, do not attempt to disassemble the cabinet. Refer servicing to qualified personnel only.

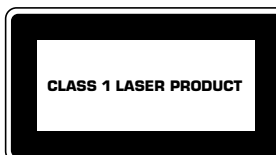

This unit is classified as a CLASS 1 LASER product. The CLASS 1 LASER PRODUCT label is located on the rear exterior.





Laser component in this product is capable of emitting radiation exceeding the limit for Class 1.

Laser Diode Properties

- Material: GaAlAs
- Wavelength: 780nm
- Emission Duration: continuous
- Laser Output: max. 44.6μW*

* This output is the value measured at a distance of about 200mm from the objective lens surface on the Optical Pick-up Block.

The Video CD player on this unit can play discs of the following types only.

Type of disc	Mark printed on the disc	Type of signal recorded	Size (Dimension)	Maximum possible play time
Video CD	 	Sound + Picture (Movie)	12 cm	74 minutes
			8 cm (Single type)	20 minutes
CD (including CD-G)	 	Sound only / Sound + Still picture	12 cm	74 minutes
			8 cm (Single type)	20 minutes

Never attempt to load a disc other than above on this unit because it may cause a damage to this unit and/or other units connected to this unit.

VIDEO CD

Video CDs are classified into two types, version 1.1 and 2.0. This unit can play not only discs of version 1.1, but also version 2.0 on which a Playback Control can be made.

Video CD, version 1.1: With the same operation as compact discs, you can enjoy sounds and pictures (movies).

Video CD, version 2.0: In addition to a normal play which is the same as discs of version 1.1, you can make a Playback Control. (For details on Playback Control, refer to page 22.)

FEATURES

The System

- **5 speaker Configuration**
 - Front L, R: 75W + 75W (6 Ω) RMS Output Power, 10% THD, 1 kHz
 - 65W + 65W (6 Ω) RMS Output Power, 1% THD, 1 kHz
 - Center: 30W (8 Ω) RMS Output Power, 10% THD, 1 kHz
 - 20W (8 Ω) RMS Output Power, 1% THD, 1 kHz
 - Rear 30W (8 Ω) RMS Output Power, 10% THD, 1 kHz
 - 20W (8 Ω) RMS Output Power, 1% THD, 1 kHz
- **Adjustable Display Brightness**
- **2 Microphone Jacks and Mic Mixing Level Control for Karaoke**
- **Echo Level and Key Level Control Capability**
- **Multi-Use Timer/Sleep Timer**
- **Automatic Power-Off Function**
- **5 External Audio/Video Component Connecting Capability**
- **SUBWOOFER Output Terminal Which Passes Low Frequencies Only**
- **Video Output Format Selector (TV MODE) Switch**
- **Remote Control Capability**

Video CD Player

- **3-Disc Carousel Auto-Changer (for Playing Back Video CDs and Compact Discs)**
- **PLAYXCHANGE; Disc Changing Capability while Playing Back Another**
- **20-Track Random Access Programmable Playback**

- **Single Track/Entire Disc/All Disc Repeat Play**
- **Random-sequence Play**
- **Playback Control Function Available for Video CDs, Version 2.0**
- **Quick Overview of a Track and a Disc with a Touch of the DIGEST and INTRO Buttons**

Tuner

- **40 Station Random Access Preset Tuning**
- **40 Station Automatic Preset Tuning**

Sound Field Processor Including Dolby Pro Logic Surround Decoder

- **2 Programs for Dolby Surround Decoding (DOLBY PRO LOGIC and DOLBY 3 STEREO)**
- **2 Programs for Sound Field Processing (HALL and ARENA)**
- **4 Programs for Singing Karaoke**
- **Automatic Input Balance Control for Dolby Pro Logic Surround**
- **2 Center Channel Modes (NORMAL/PHANTOM)**
- **Test Tone Generator for Easier Speaker Balance Adjustment**

Graphic Equalizer

- **5-Band Adjustable Graphic Equalizer**
- **4 Preset Graphic Equalizer Modes Selectable According to the Music Source (ROCK, BLUES, RAP and JAZZ)**
- **4-Sound Field and 4-Equalizer Control Mode Storing Capability**

Dolby Pro Logic Surround

This unit employs a Dolby Pro Logic Surround decoder similar to professional Dolby Stereo decoders used in many movie theaters. By using the Dolby Pro Logic Surround decoder, you can experience the dramatic realism and impact of Dolby Surround movie theater sound in your own home. Dolby Pro Logic employs a four channel five speaker system. The Pro Logic Surround system divides the input signal into four levels: the left and right main channels, the center channel (used for dialog), and the rear surround sound channels (used for sound effects, background noise, and other ambient noises). The center channel allows listeners seated in even less-than-ideal positions to hear the dialog originating from the action on the screen while experiencing good stereo imaging.

Dolby Surround is encoded on the sound track of pre-recorded video tapes, laser discs, and some TV/cable broadcasts. When you play a source encoded with Dolby Surround on this unit, the Dolby Pro Logic Surround decoder decodes the signal and distributes the surround-sound effects.



In addition, this unit features a built-in automatic input balance control. This always assures you the best performance without manual adjustment.

Manufactured under license from Dolby Laboratories Licensing Corporation. "Dolby", the double-D symbol and "Pro Logic" are trademarks of Dolby Laboratories Licensing Corporation.

NAMES OF CONTROLS AND INDICATORS

For amplifier/tuner

(See figure 1 on page 3 at the beginning part of this manual.)





- 1 **POWER** Switch
- 2 **PHONES** Jack
- 3 Remote Control Sensor
- 4 **USER** Button
- 5 User Program **MEMORY** Button
- 6 **DISPLAY** Button
- 7 **PRESET/TUNING/BAND** Selector Button
- 8 **MIC** (Microphone) Jacks
- 9 **A/B/C/D/E** Button
- 10 **MIC MIXING** (Microphone Mixing) Level Control
- 11 ∨ (Down)/ ^ (Up) Buttons
- 12 **AUTO/MAN'L (TIMER)** Button
- 13 Tuner **MEMORY (TIME ADJUST)** Button
- 14 **VOLUME** Control
- 15 **MIN** Button
- 16 **HOUR** Button
- 17 **INPUT SELECTOR**
- 18 **MUSIC** Button
- 19 Equalizer Control Buttons
(**ECHO** Buttons)
(Key Level Control  /  Buttons)
- 20 **PROGRAM** Selector Button

Display

- 1 Preset Equalizer Mode Indicator (**MUSIC**)
- 2 Sound Field Program Indicator (**PROGRAM**)
- 3 User Program Number Indicator
- 4 Center Channel Mode (**NOR/PHANTOM**) Indicator
- 5 **TEST** Indicator
- 6 **TIMER** Set Indicator
- 7 **SLEEP** Indicator
- 8 **AUTO** Tuning Indicator
- 9 **TUNED** Indicator
- 10 **STEREO** Indicator
- 11 **MEMORY** Indicator
- 12 Volume Level Meter
- 13 Graphic Equalizer Level Indicators
- 14 Preset Number Indicator
- 15 Multi Information Display
(Time, Station Frequency, Volume Level, etc.)

For Video CD player

(See figure 2 on page 4 at the beginning part of this manual.)

- 21 Disc Table
- 22 **DISC** Selector Buttons
- 23 **RANDOM** Button
- 24 Stop Button: 
- 25 Play/Pause Button:  / 
- 26 Skip Buttons:  / 
(Search Buttons:  / )
- 27 **TIME** Button
- 28 **REPEAT** Button
- 29 **OPEN/CLOSE** Button: 
- 30 **DISC CHANGE** Button

Display

- 16 **VIDEO CD** Indicator
- 17 **PBC** Indicator
- 18 **RANDOM** Play Indicator
- 19 Music Calendar Indicator
- 20 Music Calendar **OVER 15** Indicator
- 21 Disc Indicator
- 22 Track Number Indicator
- 23 Time Display
- 24 Play Indicator: 
- 25 (**S, F**) **REPEAT** Indicator
- 26 Program (**PROG**) Play Indicator

REMOTE CONTROL TRANSMITTER

Names of control buttons

(See figure 3 on page 5 at the beginning part of this manual.)

■ Amplifier/tuner control buttons

- 1 Remote Control Transmitter Window
- 2 Preset Station Number Buttons
- 3 A, B, C, D, E Selector Buttons
- 4 LEVEL Control Buttons
- 5 CENTER/REAR/DELAY Selector Button (ECHO/KEY Selector Button)
- 6 TEST Button
- 7 MUSIC Button
- 8 PROGRAM Button
- 9 SLEEP Button
- 10 VOLUME – (Down)/+ (Up) Buttons
- 11 POWER Switch
- 12 DISPLAY Button
- 13 USER Button
- 14 FLAT Button
- 15 INPUT Selector Buttons
- 16 TUNER Input Selector Button
- 17 PRESET Number ∨ (Down)/ ^ (Up) Buttons

■ Video CD player control buttons

- 18 Track Number Input Buttons
- 19 TIME Button
- 20 PROGRAM Button
- 21 Disc Play MODE Selector Button
- 22 DISC SKIP Button
- 23 INDEX Buttons
- 24 Skip Buttons: ◀◀/▶▶
(Search Buttons: ◀◀/▶▶)
(PREV/NEXT Buttons)
- 25 Stop Button: □
(RETURN Button)
- 26 Play/Pause Button: ▷/⏸
(SELECT Button)
- 27 OPEN/CLOSE Button: △
- 28 TIME INDEX Buttons
- 29 DIGEST Button
- 30 INTRO Button

Loading the batteries for the remote control transmitter

(See figure 4 on page 5.)

- 1 Remove the battery compartment cover.
(Slide the cover in the direction of the arrow.)
- 2 Insert 2 “AA” size batteries (UM/SUM-3, R6, HP-7 or equivalent) into the battery compartment.
* Installing the batteries improperly may cause failure.
- 3 Replace the battery compartment cover.

Precautions for battery use

- Insert the batteries according to the direction indicated in the battery compartment.
- Replace all batteries with new ones at the same time.
- Remove the batteries if they are weak or if the unit is not in use for long periods.
- Don't mix normal batteries with rechargeable batteries.

Proper use of the remote control transmitter

(See figure 5 on page 5.)

Aim (within the range of 60° with no obstacles) the remote control transmitter at the remote control sensor and operate as shown.

Notes concerning use

- Replace the batteries if control distance decreases or operation becomes unstable.
- Periodically clean the transmitter window on the remote control transmitter and the sensor on the main unit with a soft cloth.
- Exposing the sensor on the main unit to strong light (especially an inverter type of fluorescent lamp etc.) may interfere with operation. In this case, reposition the main unit to avoid direct lighting.
- Keep the remote control transmitter away from moisture, excessive heat, shock and vibrations.
- The remote control transmitter's usable range is within 0.2m (8") and 6m (20') away from the sensor.

SETTING UP THE SPEAKERS

This unit designed to provide the best sound-field quality with a 5-speaker configuration: front speakers, rear speakers and a center speaker. You may omit the center speaker, if for some reason it is not practical to use a center speaker. (Refer to the “**4-Speaker Configuration**” shown below.)

The front speakers are used for the main source sound plus the effect sounds. The rear speakers are used for the effect and surround sounds, and the center speaker is for the center sounds (dialog etc.).

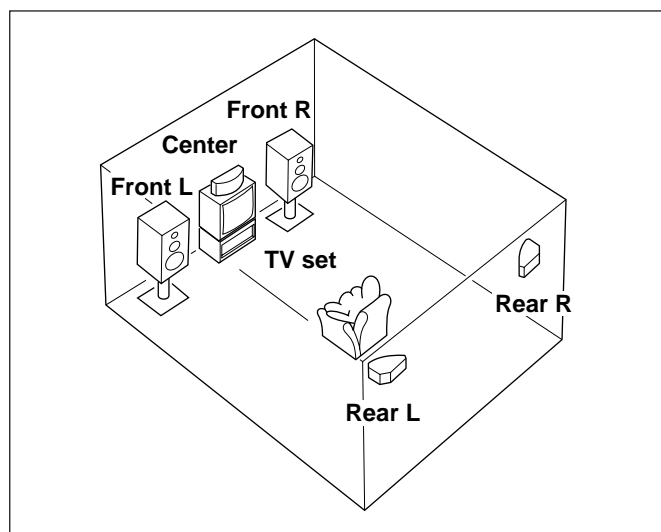
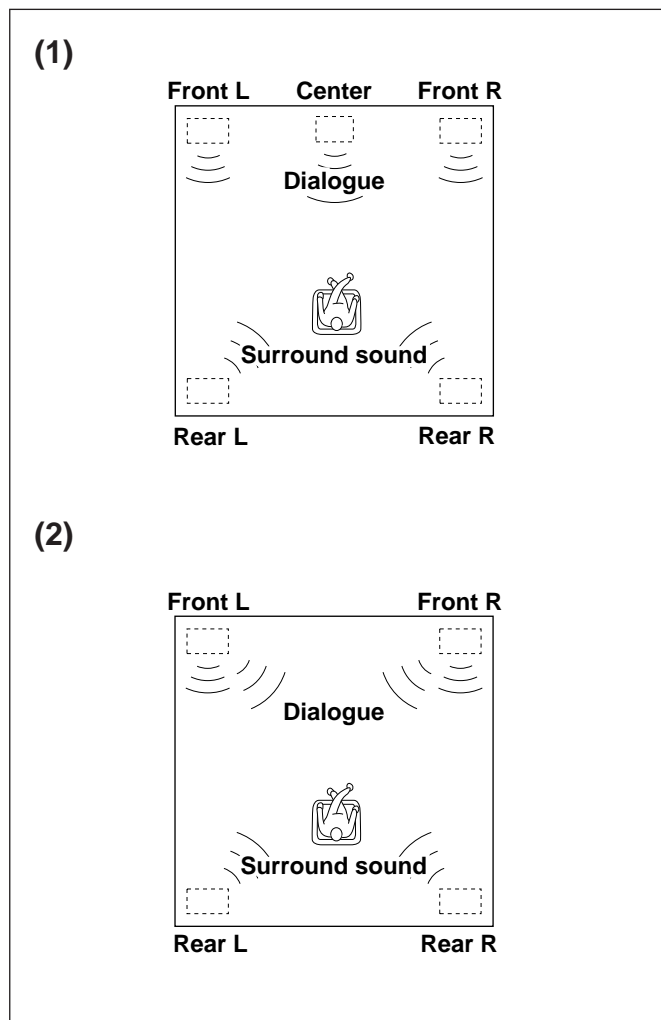

Speaker configuration

(1) 5-Speaker Configuration

This configuration is the most effective and recommended one. In this configuration, the center speaker is necessary as well as the rear speakers. If the sound field program **DOLBY PRO LOGIC** or **DOLBY 3 STEREO** is selected, conversations will be output from the center speaker and the ambience will be excellent.

- Set the center channel mode to the “**NORMAL**” position. (For details, refer to page 12.)

(2) 4-Speaker Configuration

The center speaker is not used in this configuration. If the sound field program **DOLBY PRO LOGIC** is selected, the center sound is output from the left and the right front speakers, although the program **DOLBY 3 STEREO** is useless in this configuration. However, the sound effect of other programs can be the same as that of the 5-speaker configuration.

- Be sure to set the center channel mode to the “**PHANTOM**” position. (For details, refer to page 12.)

Note

Be sure to use two rear speakers. If you connect one rear speaker only, sound will not be output from the rear speaker.

Speaker placement

- Front speakers:** In normal position.
- Rear speakers:** Behind your listening position, facing slightly inward. Nearly 1.8 m (approx. six feet) up from the floor.
- Center speaker:** Precisely between the front speakers.

CONNECTIONS

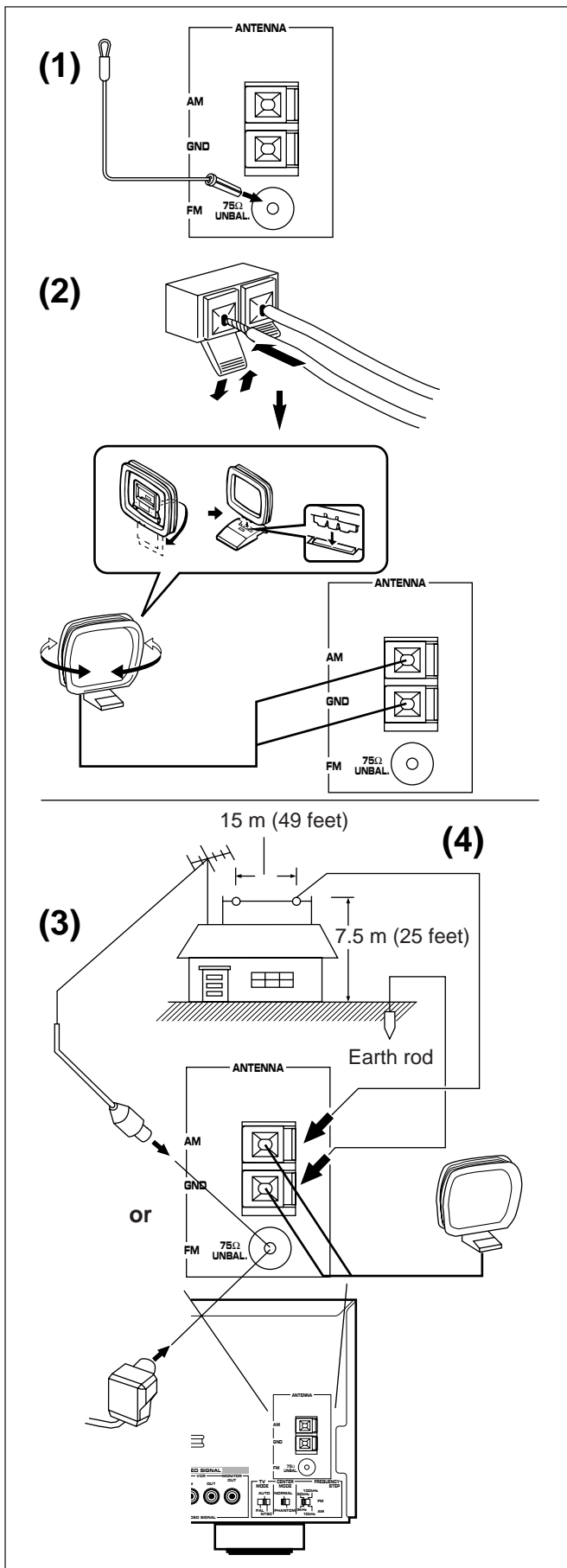

Antenna connection

(1) Supplied FM antenna

Connect the FM antenna wire to the corresponding terminal and direct the FM antenna wire to the direction where the strongest signal can be received.

(2) Supplied AM loop antenna

Connect the AM loop antenna wires to the corresponding terminals. Position the AM loop antenna for optimum reception. Place the AM loop antenna on a shelf etc., or install it on the rack or wall with screws (not supplied).

Notes

- When static is still heard even after adjusting the position of the AM loop antenna, try reversing the wire connections (from the upper terminal to the lower terminal, and vice versa).
- Do not place the AM loop antenna on the unit. It will result in noise generation, since the unit is equipped with digital electronics. Place the AM loop antenna away from the unit.

(3) External FM antenna

Use an external FM antenna instead of an indoor FM antenna if you need better reception. Consult your dealer.

(4) External AM antenna

Use an external AM antenna if you need better reception. Consult your dealer.

Note

When using an external AM antenna, be sure to keep the wire of the AM loop antenna connected.

FREQUENCY STEP switch (China and General models only)

Because the interstation frequency spacing differs in different areas, set the FREQUENCY STEP switch (located at the rear) according to the frequency spacing in your area. Before setting this switch, disconnect the AC supply lead of this unit from the AC outlet.

CONNECTIONS

Never plug the AC supply lead of this unit into the AC outlet until all connections are completed.

Connecting speakers

(See figure 6 on page 6.)

Connect the front speakers to the FRONT SPEAKERS terminals, the center speaker to the CENTER SPEAKERS terminals and the rear speakers to the REAR SPEAKERS terminals.

Note

Use speakers with the specified impedance shown on the rear of this unit.

Note on connecting a subwoofer (separate purchase)

You may wish to add a subwoofer to reinforce the bass frequencies.

Connect the SUBWOOFER OUT terminal on the rear of this unit to the INPUT terminal of the subwoofer amplifier, and connect the speaker terminals of the subwoofer amplifier to the subwoofer.

With some subwoofers, including the Yamaha Active Servo Processing Subwoofer System, the amplifier and subwoofer are in the same unit.

* The SUBWOOFER OUT terminal is for output to a monaural amplifier driving a subwoofer. Only frequencies below 200 Hz from the front and center channels are output.

How to Connect:

Connect the **SPEAKERS** terminals to your speakers with wire of the proper gauge, cut as short as possible. If the connections are faulty, no sound will be heard from the speakers. Make sure that the polarity of the speaker wires is correct, that is the + and – markings are observed. If these wires are reversed, the sound will be unnatural and lack bass.

Caution

Do not let the bare speaker wires touch each other as this could damage the amplifier and/or speakers.

Red: positive (+)
Black: negative (–)

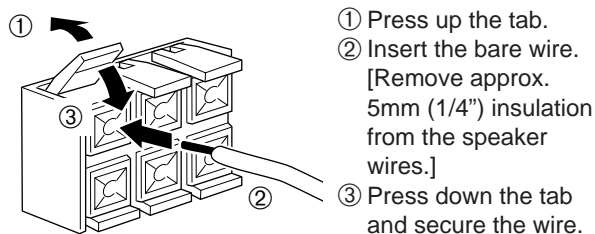

Connecting external components

(See figure 7 on page 7.)

This unit can be connected with external audio and video components. Make connections between this unit and other components using RCA pin plug connector cables correctly, that is to say **L** (left) to **L** and **R** (right) to **R**. Also, refer to the owner's manual for each component to be connected to this unit.

*

AC OUTLET (UNSWITCHED)

The power cord of any audio/video unit can be connected to this outlet.

The power to this outlet is not controlled by this unit's POWER switch. This outlet will supply power to the connected unit even if this unit is in the standby mode.

The maximum power that can be connected to this outlet is 100 watts.

Connecting the AC supply lead

(See figure 8 on page 8.)

- After completing all connections, plug the AC supply lead into a convenient AC outlet.
- Unplug the AC supply lead from the AC outlet if the unit is not to be used for a long period of time.

SETTING THE VIDEO OUTPUT FORMAT SELECTOR (TV MODE) SWITCH

(See figure 9 on page 8.)

The Video CD player on this unit is designed for use with the NTSC and PAL television formats. Set this switch to the position for the format your monitor TV employs.

PAL: Outputs signals in the PAL format no matter which format (PAL or NTSC) the currently playing disc employs.
Set to this position if your monitor TV employs the PAL format.

AUTO: Outputs signals in the same format as the currently playing disc employs.
Set to this position if your monitor TV can be switched in between the PAL and NTSC formats automatically.

NTSC: Outputs signals in the NTSC format no matter which format (PAL or NTSC) the currently playing disc employs.
Set to this position if your monitor TV employs the NTSC format.

Note

Make sure to play back a disc which employs the same format that your monitor TV employs, otherwise a picture will not be played back normally.

TURNING THE POWER TO THIS UNIT ON OR IN THE STANDBY MODE

(See figure 10 on page 8.)

If the AC supply lead is connected to the AC outlet, this unit can be turned on and turned into the standby mode by pressing the POWER switch on the front panel or the POWER switch on the remote control transmitter.

- While the power is on, the display shows the name of currently selected input source or other information.
In the standby mode, the display shows only the time.

Automatic function to turn this unit into the standby mode

The power of this unit will be automatically turned into the standby mode if there is no operation on the control parts of this unit, no illumination on the graphic equalizer level indicators and no playback of Video CD (CD) for about 30 minutes.

- * This function is not available unless time setting is made on the built-in clock.

Standby mode

While the power is on, pressing the POWER switch (or the POWER switch on the remote control transmitter) switches this unit to the Standby mode. (In this mode, the display shows only the time.) In this mode, main voltage is still present inside this unit. If you want to switch off this unit completely, disconnect the AC power plug from the AC outlet.

SETTING THE CLOCK

(See figure 11 on page 8.)

- 1 While the power is on, press the DISPLAY button to display the time. If this unit is into the standby mode, you can proceed to the next step.
- 2 While holding the TIME ADJ button pressed, press the HOUR button and set the hour.
 - * Press the HOUR button once to advance the time by 1 hour. Press and hold to advance continuously.
- 3 While holding the TIME ADJ button pressed, press the MIN button and set the minute.
 - * Press the MIN button once to advance the time by 1 minute. Press and hold to advance continuously.

Singapore model uses a 24-hour display. China and General models use either a 24-hour display or a 12-hour display [shown by "AM (PM) 12:00"] is selected depending on the setting of the FREQUENCY STEP switch on the rear panel, so you cannot select a desired type freely.

In the event of a power failure or when the AC supply lead is disconnected.

The time display will go out, however, the clock will function for about 5 minutes without power supply. So you do not have to reset the time if the AC power supply is resumed within about 5 minutes.

When the AC power supply is resumed after more than 5 minutes pass without power supply, the time display will flash on and off to indicate that the time must be reset.

ADJUSTING BRIGHTNESS OF THE DISPLAY

If desired, you can adjust brightness of the display.

- 1 Press and hold the DISPLAY button for more than 2 seconds so that "DIMMER±0" appears on the display.
- 2 Holding the DISPLAY button pressed, turn the VOLUME control clockwise to increase or counterclockwise to decrease brightness.

This adjustment can be made even though this unit is in the standby mode.

Control range

When the power is on: ±0 to -6 (Preset value: ±0)
In the standby mode: +3 to -3 (Preset value: ±0)

VOLUME CONTROL

(See figure 12 on page 8.)

Front panel operation

Rotate the VOLUME control clockwise to increase the volume, and counterclockwise to decrease the volume.

Remote control operation

Press the VOLUME + button to increase the volume and the VOLUME - button to decrease the volume.

* Adjusted volume level is shown by the volume level meter and in figures on the display.

LISTENING WITH HEADPHONES

(See figure 13 on page 8.)

- Be sure that your headphones have a 3.5 mm (1/8") diameter plug and are between 16 ohms and 50 ohms impedance. Recommended impedance is 32 ohms.
- When headphones are connected, the speakers are defeated automatically and you can listen to the sound to be output from the front speakers through headphones. Adjust the VOLUME control for desired volume.

CARE OF VIDEO CDS (CDS)

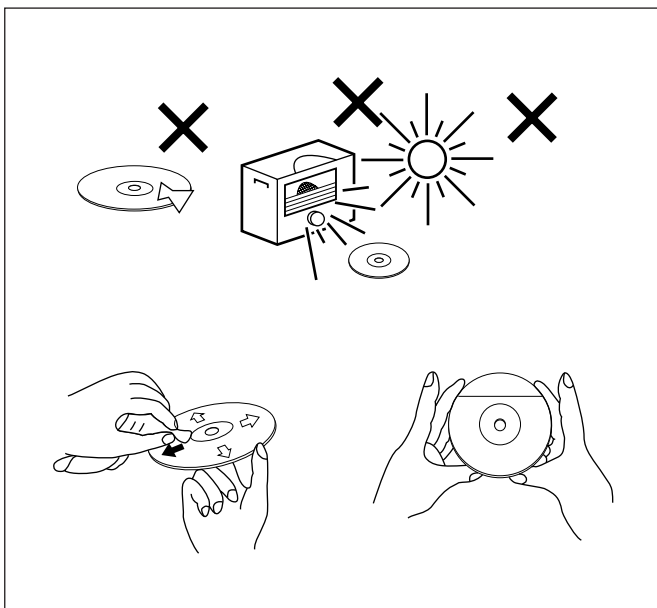

Discs are fairly resistant to damage, however mistracking can occur due to an accumulation of dirt on the disc surface. Follow the guidelines below for maximum enjoyment from your disc collection and player.

- Do not write on either side of the disc, particularly the non-label side. Signals are read from the non-label side. Do not mark this surface.
- Keep your discs away from direct sunlight, heat and excessive moisture.
- Always hold the discs by the edges. Fingerprints, dirt or water on the discs can cause noise or mistracking. If a disc is dirty or does not play properly, clean it with a soft, dry cloth, wiping straight out from the center, along the radius.

SPEAKER BALANCE ADJUSTMENT

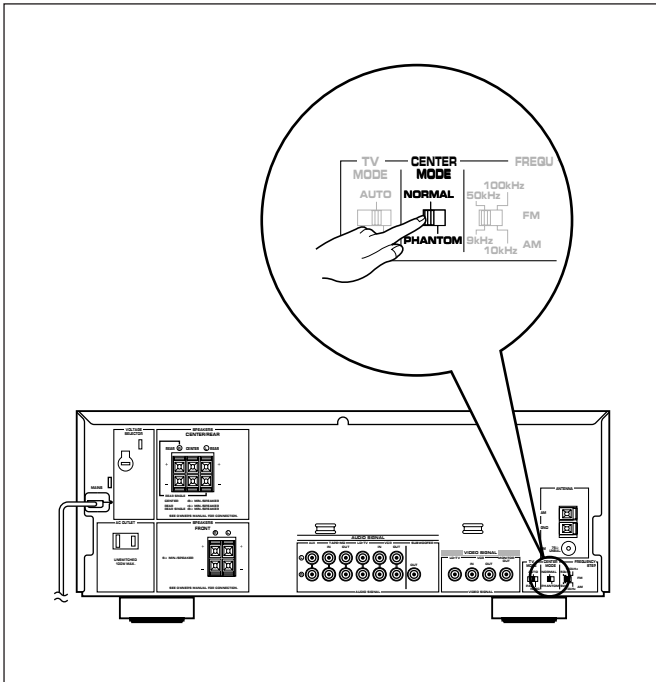

This procedure lets you adjust the sound output level balance between the front, center, and rear speakers using the built-in test tone generator. When this adjustment is performed, the sound output level heard at the listening position will be the same from each speaker. This is important for the best performance of the built-in Dolby Pro Logic surround decoder. **The adjustment of each speaker output level should be done at your listening position with the remote control transmitter. Otherwise, the result may not be satisfactory.**

Before operation

Set the CENTER MODE switch on the rear panel of this unit to the position suitable for your speaker system configuration. (Refer to page 7 for details.)

NORMAL (For 5 speaker configuration):

Select this position when you use the center speaker.

PHANTOM (For 4 speaker configuration):

Select this position when you do not use the center speaker. The center sound will be output from the left and right front speakers.

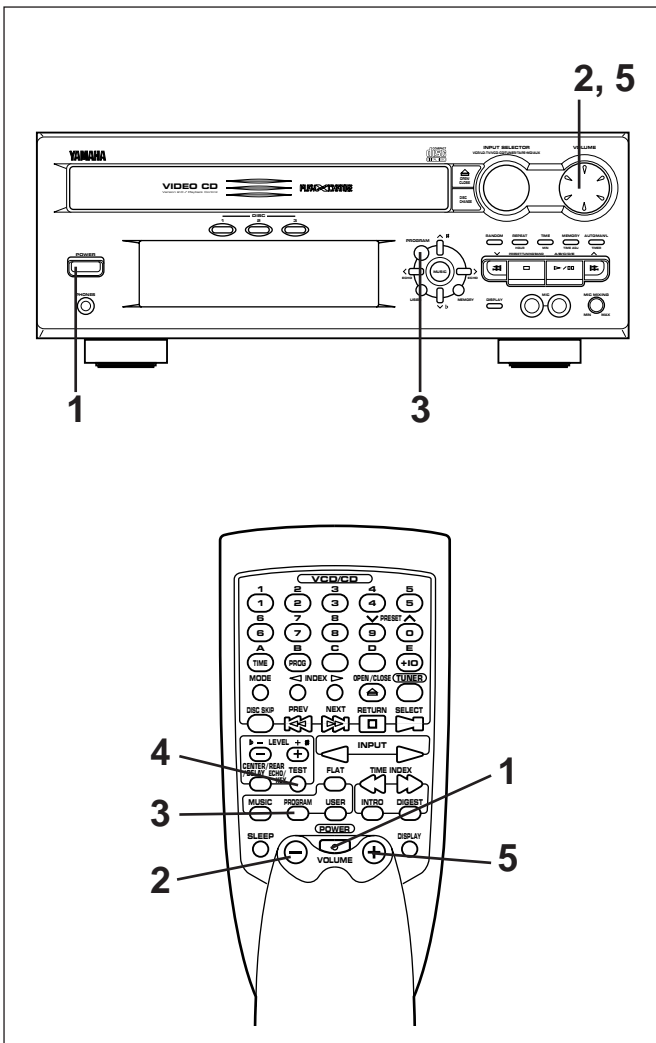

- 1 Press the POWER switch to turn the power on.
- 2 Turn the VOLUME control fully counterclockwise to decrease the volume to minimum.
- 3 Press the PROGRAM button once or more so that "PRO LOGIC" lights up on the sound field program indicator.
- 4 Press the TEST button.
* "TEST" flashes on and off on the display.
- 5 Press the VOLUME + (up) button to increase the volume.

You will hear a test tone (like pink noise) from the left front speaker, then the center speaker, then the right front speaker, and then the rear speakers, for about two seconds each. The display changes as shown below.

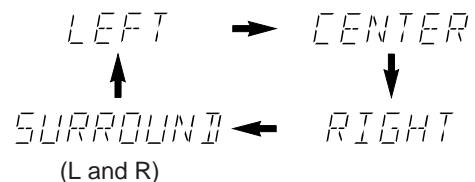

* The test tone from the left rear speaker and the right rear speaker will be heard at the same time.

SPEAKER BALANCE ADJUSTMENT

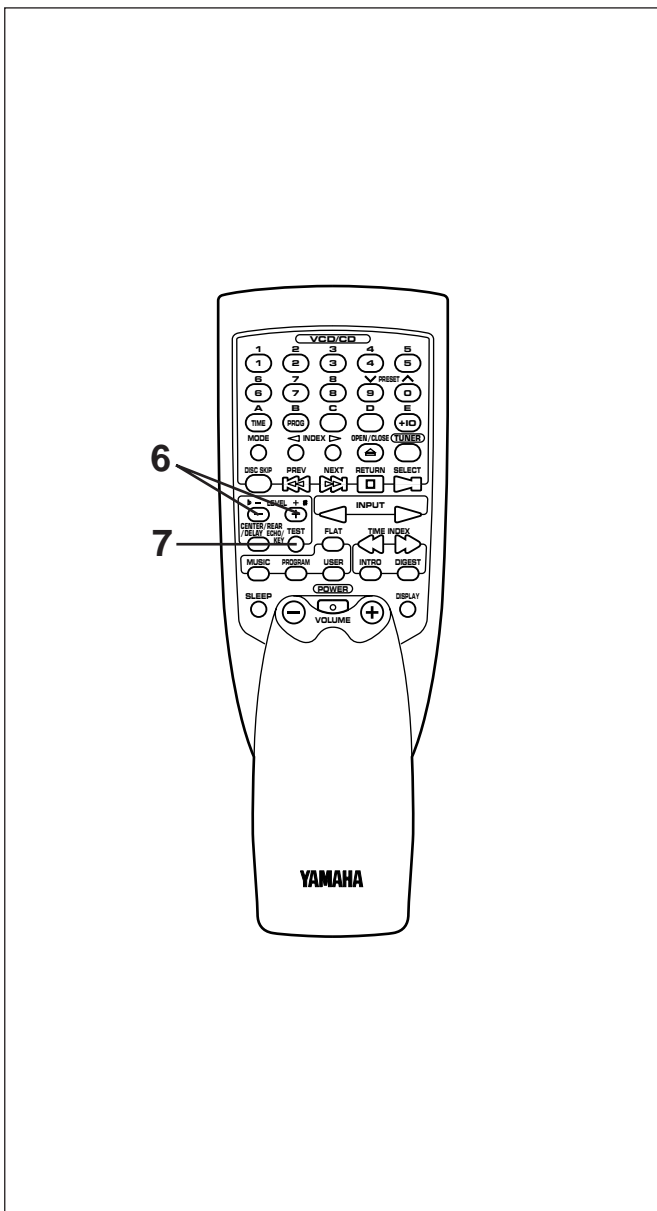

6 Adjust the sound output levels of the center speaker and the rear speakers by using the LEVEL control buttons so that they become almost as same as that of the front speakers.

- When the test tone is output from the center speaker, pressing the LEVEL control buttons change the output level of the center speaker.

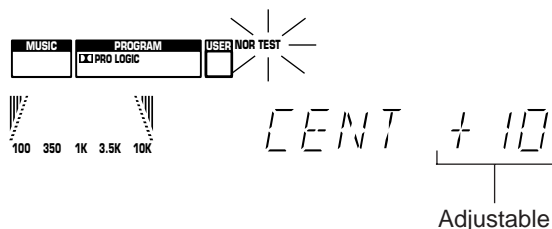

- When the test tone is output from the rear speakers, pressing the LEVEL control buttons changes the output level of the rear speakers.

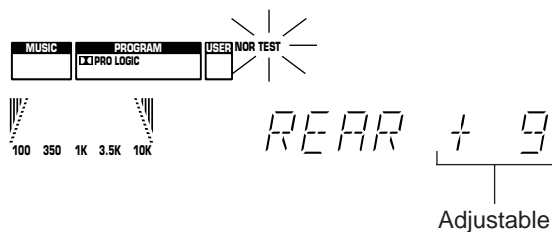

- * Pressing the + button raises and the – button lowers the level.

7 If the adjustments have finished, press the TEST button to cancel the test tone.

- * "TEST" disappears from the display.

Notes

- Once you have completed these adjustments, you can adjust whole sound level on your audio system by using the VOLUME control (or the VOLUME keys on the remote control transmitter) only.
- In step 6, if the center channel mode is in the "PHANTOM" position, the sound output level of the center speaker cannot be adjusted. This is because in this mode, the center sound is automatically output from the left and right front speakers.



VIDEO CD PLAYER OPERATION

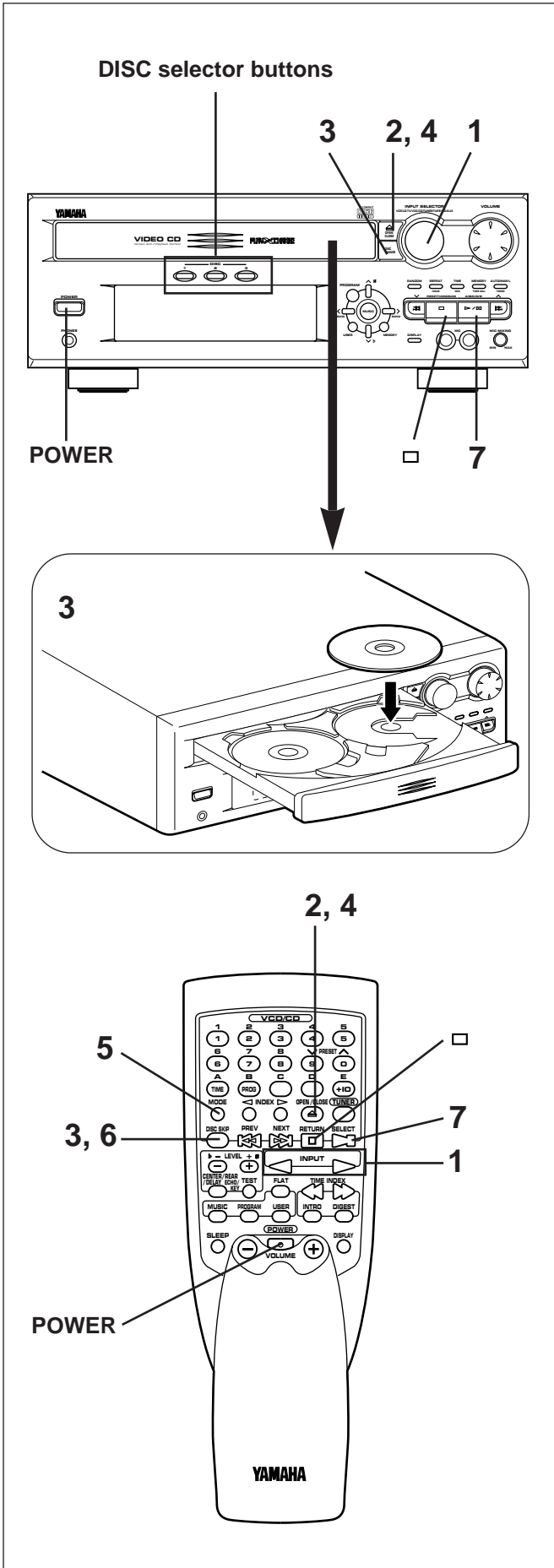

The procedures on this section (from page 14 to 21) are ineffective when this unit is in the Playback Control mode. For information about the Playback Control operation of Video CDs, version 2.0, refer to pages 22–24.

CD/Video CD playback

* If you will play back a Video CD, turn on the monitor TV connected to this unit.

- 1 Select the Video CD player by turning the INPUT SELECTOR until "VCD/CD" appears on the display.
- 2 Press the OPEN/CLOSE button to open the disc table.
- 3 Place discs on the trays, label side up.
 - * Up to three discs can be loaded on the trays.
 - To load the third disc, rotate the disc table by pressing the DISC CHANGE button on the front panel or the DISC SKIP button on the remote control transmitter.
 - * 8 cm (3") discs may be played without an adaptor.
- 4 Press the OPEN/CLOSE button to close the disc table.
 - * The total number of tracks and the total playing time of the disc being selected will be displayed for several seconds.
 - * The music calendar will be displayed only for the number of tracks on the disc being selected.
 - * If the disc contains more than 15 tracks, the "OVER 15" indicator will light up on the music calendar.
 - * If the selected disc is a Video CD, "VIDEO CD" lights up on the display.

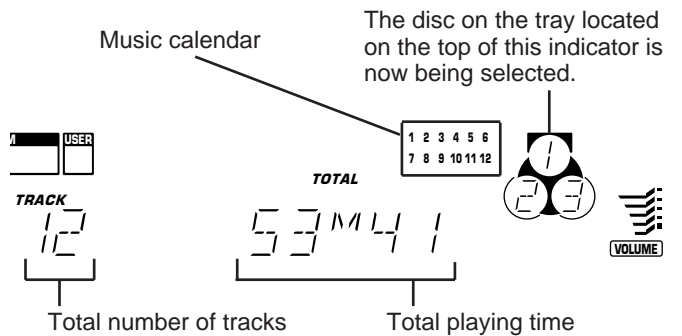

- 5 If necessary, change the disc play mode by pressing the disc play MODE selector button on the remote control transmitter watching the display.

Single disc play mode: Only a designated disc is played back.
All disc play mode: All discs on the disc table are played back sequentially.

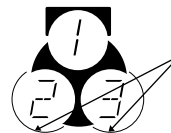

Lights up only when the all disc play mode is selected.

- 6 If necessary, select another disc by pressing the DISC SKIP button on the remote control transmitter once or more (so that the corresponding disc tray number is located on the top of the disc indicator).
- 7 Press the play/pause button to start playback from track 1.
 - * The "▶" indicator will appear and playback will begin. As the playback of each track on the music calendar is finished, that track number will go out.



VIDEO CD PLAYER OPERATION

For easier operation

Pressing the DISC selector button (1, 2 or 3) will select the disc directly, and playback will begin from track 1 automatically.

Note

If a Video CD, version 2.0 is selected, "PBC" lights up on the display, and the total number of tracks, the total playing time of the disc and the music calendar will not be displayed. In this mode, disc playback is controlled by the rule of Playback Control. (For details of Playback Control, refer to page 22-24.)

To cancel this mode and restore the normal playback mode, press the stop □ (RETURN) button. "PBC" disappears from the display.

To call the Playback Control mode again, press and hold the stop □ (RETURN) button for more than 2 seconds.

To interrupt playback

- 1 Press the play/pause ▷/⏸ button.
* The "▷" indicator will flash.

- 2 Press the play/pause ▷/⏸ button to resume playback from the same point.

To stop playback

Press the stop □ button.

To switch the unit in the standby mode after use

Turn the unit into the standby mode by pressing the POWER switch. (The indicators will go off except for the current time display.)

Direct operation

When this unit is in the standby mode, pressing the DISC selector (1, 2 or 3) button will turn the power on and start disc playback automatically.

When the power is on, even if an input source other than Video CD player is selected, pressing a DISC selector button or closing the disc table by pushing the front edge of the disc table gently will start playback directly.

* These ways of playback can also be used to close the disc table. If the table is closed in these ways, playback will begin automatically, however, the display will not show the total number of tracks and the total playing time of the disc to be played back.

PLAYXCHANGE

During playback, you can open the disc table by pressing the DISC CHANGE button without interrupting playback.

However, in this state, pressing the DISC SKIP button or a DISC selector button has no effect.

Precautions

- If TV or radio interference occurs during Video CD player operation, move the unit away from the TV or radio.
- Subjecting the unit to shock or vibration can cause mistracking.
- Playing back some discs at high volume can cause mistracking. In this case, listen at lower volume.
- Do not pull open the disc table forcibly with your hands.
- Do not push the disc table while it is moving.
- If the power fails while the table is open, wait until the power supply returns or gently push the table manually to close it.
- The temperature range for playing back discs is recommended to be 5°C (41°F) – 35°C (95°F).

Direct-selection playback

By using the track number input buttons on the remote control transmitter, any track you wish to listen to can be played back directly.

Use the track number input buttons to select the desired track number. Playback will begin automatically.

A. For example, to choose selection 5
Press the "5" button.

B. For example, to choose selection 12
(1) Press the "+10" button.
(2) Within 3 seconds, press "2" button.

C. For example, to choose selection 20
(1) Press the "+10" button.
(2) Within 3 seconds, press the "+10" button again.
(3) Within 3 seconds, press the "0" button.

Note

If you select a track number higher than the number of tracks on the disc, playback will begin from the last track on the disc.

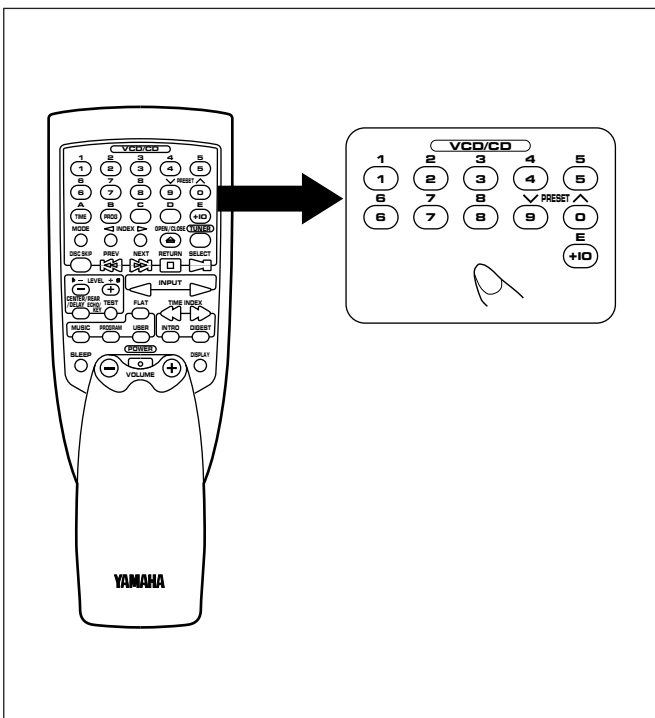



VIDEO CD PLAYER OPERATION

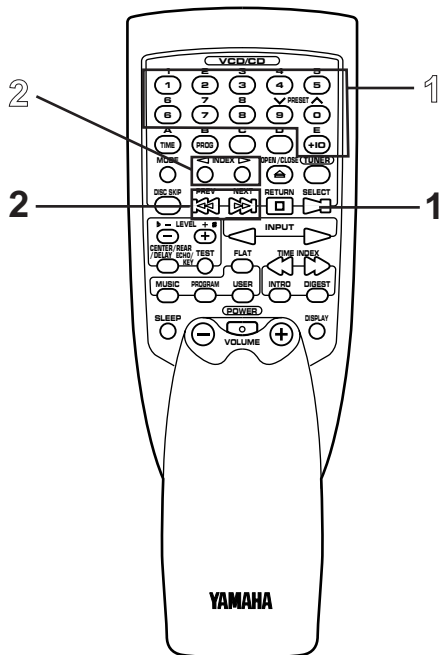
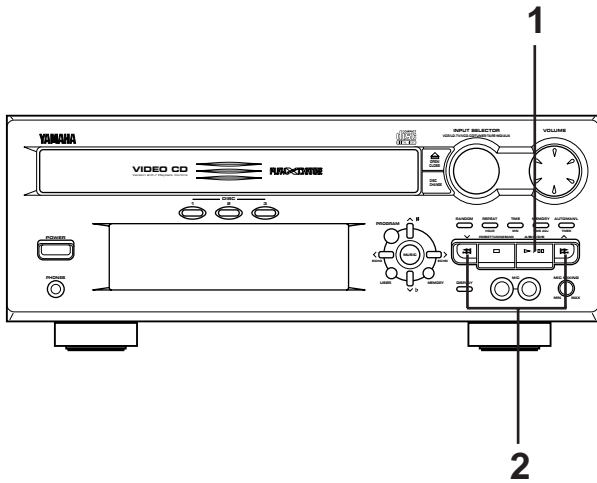

“Skip search” and “Manual search” are performed using the same buttons.

To playback a desired track on the disc (Skip search)

The beginning of any track can be found automatically.

- 1 Select a disc and begin playback.
- 2 Press the $\triangleright\triangleright$ button to advance or $\triangleleft\triangleleft$ button to reverse through the disc. Press once for each track to be advanced or reversed.
 - Press $\triangleright\triangleright$ once to advance to the track following the one now playing back.
 - Press $\triangleleft\triangleleft$ once to return to the start of the track now playing back.
 - Press $\triangleleft\triangleleft$ twice to return to the track before the track now playing back.

Notes

- This function can also be performed while the unit is stopped. Press the play/pause \triangleright/\square button when your desired track number appears on the track number display. Playback will begin from the beginning of the track.
- This function will be performed forward or backward from any point on the disc. However, it will not move forward during playback of the final track.

To advance or reverse playback rapidly (Manual search)

- 1 Begin playback.
- 2 Press and hold the $\triangleright\triangleright$ button to advance playback rapidly, and the $\triangleleft\triangleleft$ button to reverse playback rapidly.
 - * The sound can be heard (although slightly garbled) during manual search in either direction. This is convenient for reviewing the contents quickly.

Notes

Manual search can also be performed while playback is paused, though no sound will be heard.

Index search

If the currently selected disc includes index numbers, playback can be started from any desired index number.

- 1 Select a track which has index numbers by using the track number input buttons.
- 2 Pressing the INDEX \triangleleft or \triangleright button once or more searches for and select any index number. Play starts from the point of selected index number.

Notes

- If an index number is selected that is higher than any index number on that disc, playback will start from the last index number point on the disc.
- If the disc has no encoded index points, playback will begin from the start of the selected track.



VIDEO CD PLAYER OPERATION

Program play

You can program up to 20 tracks in any desired order.

- 1 Load discs and close the disc table.
- 2 When in the stop mode, press the PROG button to prepare for programming.
 - * "PROG" and "P-01" will light up on the display, and all track numbers on the selected disc begin flashing.
- 3 If necessary, select a desired disc by pressing the DISC SKIP button.
 - * Just after you change the disc, this unit reads the contents of the newly selected disc for a few seconds. During this internal operation, if you go on to the next step, "WAIT" appears on the display and your operation is canceled.
- 4 Use the track number input buttons to select the desired track number.
 - * The selected track number and the total play time of the programmed tracks will light up on the display, and soon it is replaced by the display of the next playback order. Programmed track numbers on the selected disc will stop flashing and light up on the music calendar.
 - * Pressing the TIME button displays the total play time of the programmed tracks for about 1 second, and then it is replaced by the display of the next playback order.
- * **For example, to choose selection 12**
 - (1) Press the "+10" button.
 - (2) Within 3 seconds, press the "2" button.
- 5 Repeat steps 3 and 4 for any other track. Up to 20 tracks can be programmed.
- 6 Press the play/pause button to start playback of programmed tracks.

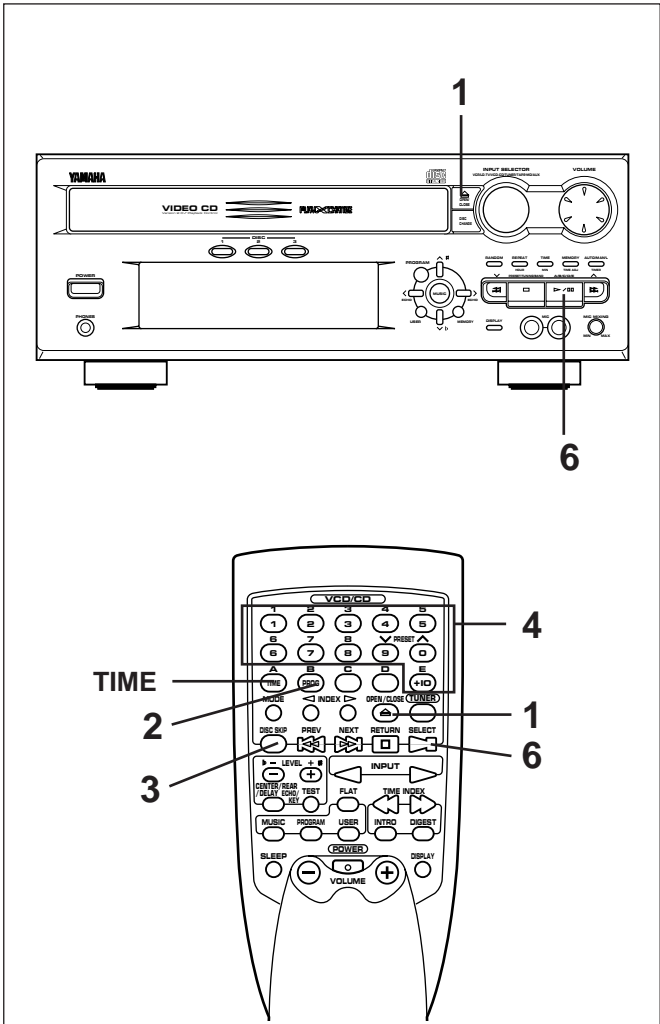

Display information during programming

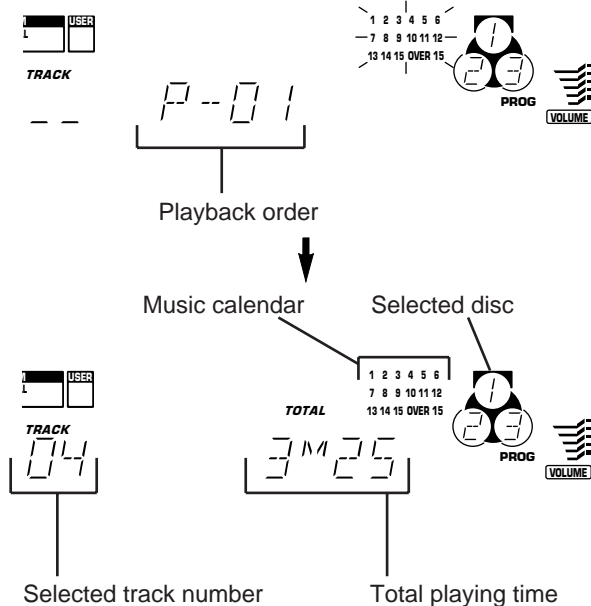

Notes

- When this unit is in the Playback Control mode ("PBC" is illuminated on the display), programming operations cannot be made.
- It is also possible to program a sequence of tracks while looking at the list of tracks on the surface of the disc before closing the disc table.
- During playback or pause, programming is not possible.
- If the total time of the programmed tracks becomes 100 minutes or more, the highest position of a figure will not be displayed.
- The total time of the programmed tracks will not be displayed, if track number 16 or higher is programmed.
- Skip search can be performed during playback, but only within the range of the programmed tracks.
- Manual search can be performed during playback to search all tracks, including unprogrammed tracks.
- If programs are made selecting tracks from more than one disc, pressing the DISC CHANGE button is useless during program play.



VIDEO CD PLAYER OPERATION

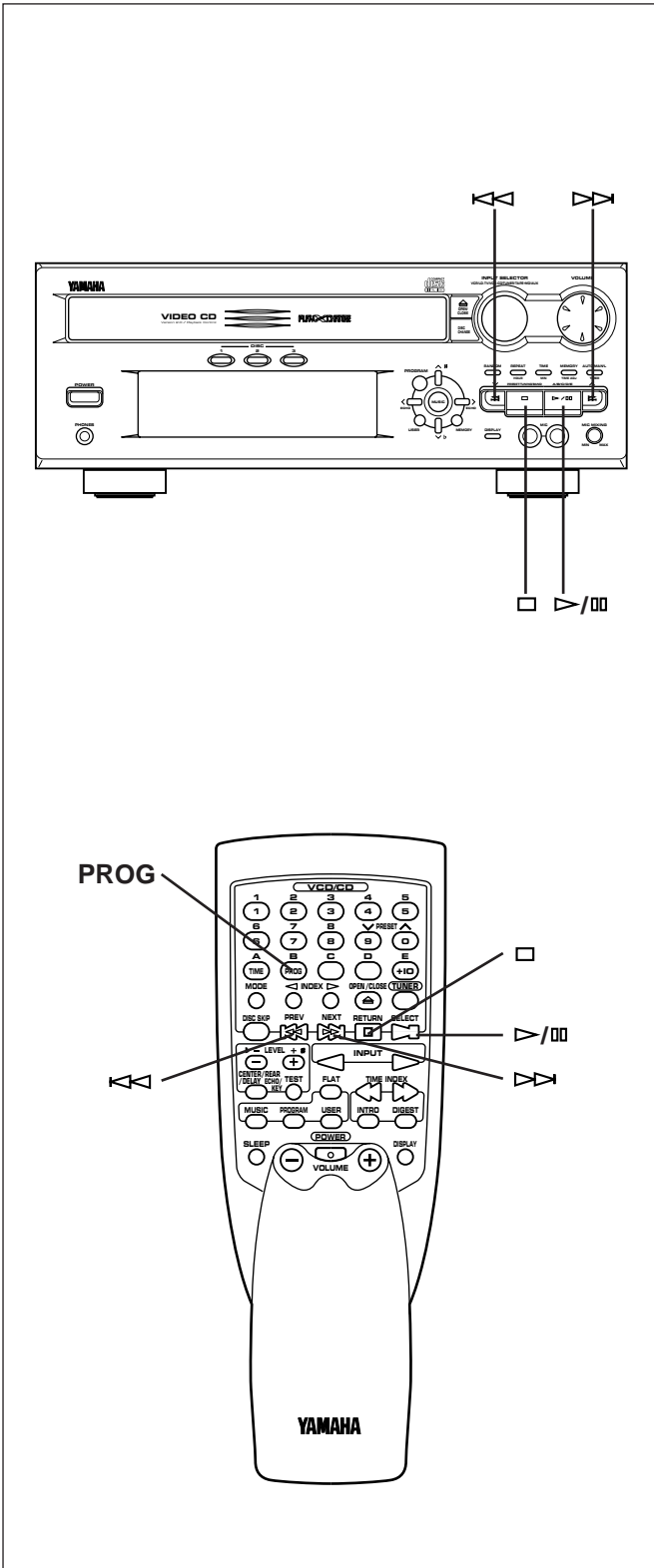

To stop program play

- Press the stop □ button. The first programmed track number will be displayed.
- To resume playback, press the play/pause ▷/⏸ button. Playback will begin from the beginning of the program.

To cancel a programmed sequence

There are several methods as described below.

- Press the stop □ button while the unit is stopped.
- Open the disc table
- Turn this unit into the standby mode.

To check program data

1. If during playing back, press the stop □ button.
2. Press the PROG button.
3. Each time the ▷▶ button is pressed, the track numbers and sequential order of the programmed tracks can be checked one after another. The display of the track number can be returned (sequentially in reverse order) by pressing the ◀◀ button.

To correct program data

1. Follow the procedure described in "To check program data".
2. Display the track number to be corrected by pressing the ▷▶ or ◀◀ button.
3. Press a track number input button to select a track to replace the one displayed. The previously programmed track will be cleared from the memory and the new one will be programmed.
4. When the correction has finished, press the PROG button or play/pause ▷/⏸ button once again.



VIDEO CD PLAYER OPERATION

Repeat play

All discs, an entire disc, a single track or a programmed sequence can be continuously repeated.

- 1 While watching the display, press the REPEAT button once or more to select a desired repeat play mode (S REP or F REP).
- 2 Press the play/pause \triangleright / \square button.

Repeat play modes

SINGLE REPEAT (S REP)

A single track is played back repeatedly.
 * This is also available in the program play mode and the random play mode. (If the repeat play mode is switched off, the program play mode or the random play mode will be resumed.)

FULL REPEAT (F REP)

When the unit is in the single disc play mode:

A designated disc is played back repeatedly.
 * In the random play mode, the selected disc is repeatedly played back, but the order of tracks is different every time.

When the unit is in the all disc play mode:

All discs on the disc table are played back repeatedly.
 * In the random play mode, the random play is performed among all discs and repeated with a different order of tracks every time.

Notes

- In the program play mode, a sequence of programmed tracks is played back repeatedly.
- When this unit is in the Playback Control mode ("PBC" is illuminated on the display), no repeat play mode can be selected.

To cancel the repeat play

Press the REPEAT button once or more so that the (S, F) REP indicator goes out.

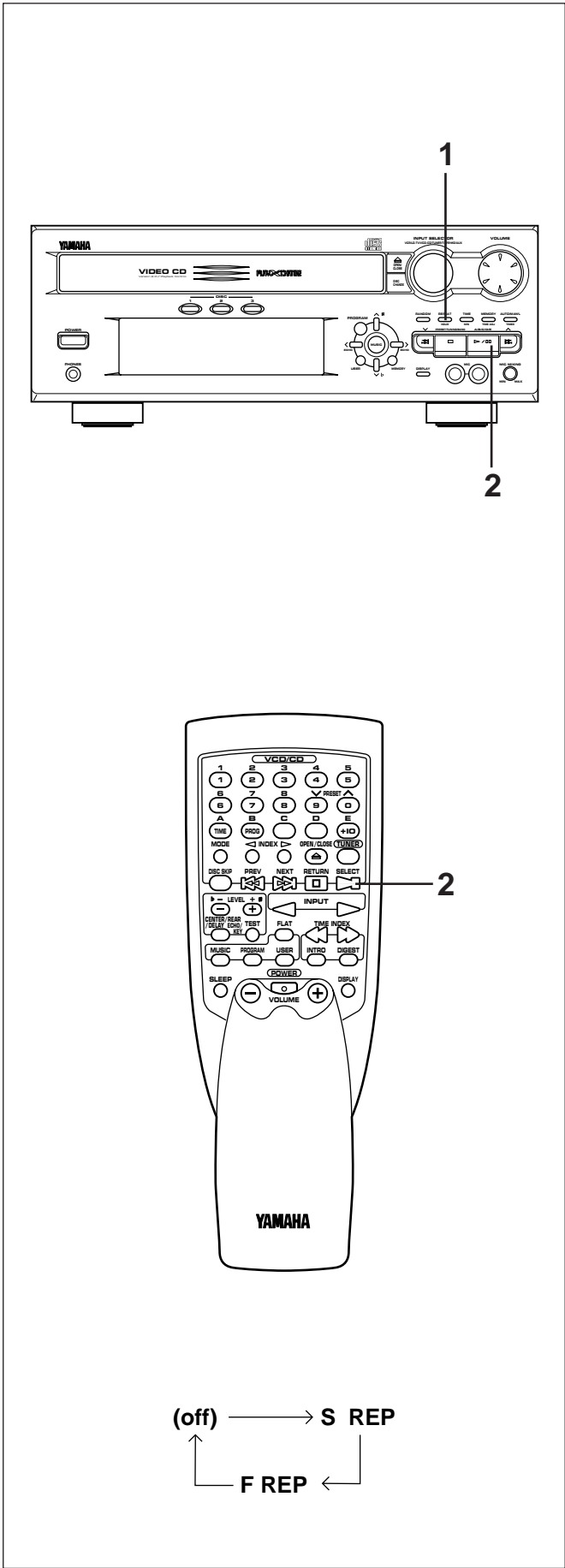



VIDEO CD PLAYER OPERATION

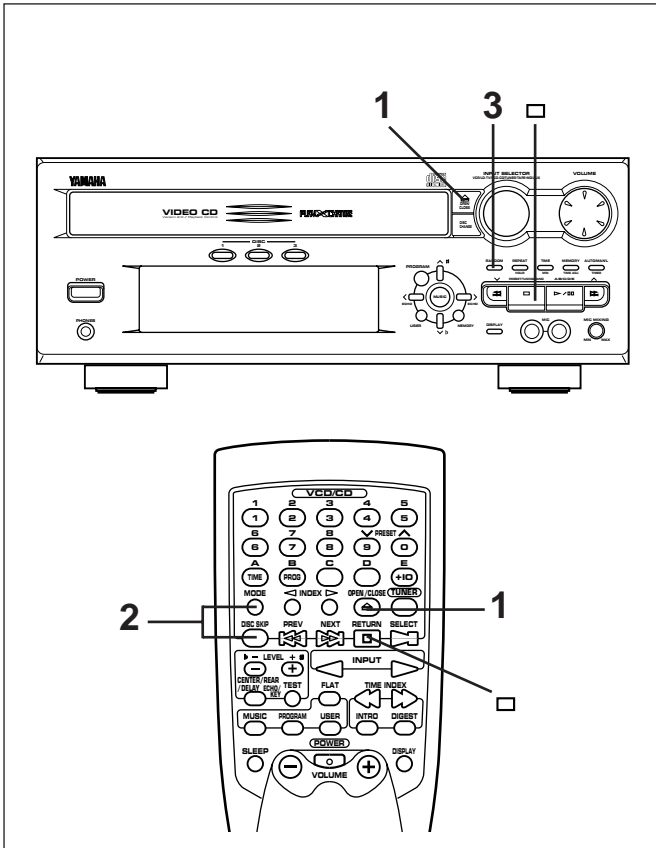

Random play

Tracks on a selected disc or all discs on the disc table can be played back in a random order.

- 1 Load discs and close the disc table.
- 2 If necessary, switch the disc play mode by pressing the disc play MODE selector button.
 - * If the single disc play mode is selected, select a desired disc by pressing the DISC SKIP button.
- 3 Press the RANDOM button to begin random play.
 - * The "RANDOM" indicator will light up.

To cancel the random play

Press the stop  button, or press the RANDOM button again. The "RANDOM" indicator will go out.

Notes

- This feature will not function during programming, or during program play.
- This feature will not function when this unit is in the Playback Control mode ("PBC" is illuminated on the display).

Switching the time display

Each time the TIME button is pressed, the display will change as described below.

[Example]

When the second track is being played back (Refer to the illustration on the left.)

- ① The elapsed play time for the track now playing back will be displayed.
 - * 8 seconds have passed since the beginning of the second track.
- ② The remaining play time for the current track will be displayed.
 - * 2 minutes and 58 seconds remain till the end of the second track.
- ③ The total play time of the disc will be displayed. (If the unit is in the program play mode, the total play time of the programmed tracks will be displayed.)
- ④ The total remaining play time from the point being played at that time will be displayed.
 - * 41 minutes remain till the end of the disc.

Notes

- During random play, the total remaining play time on the disc will not be displayed.
- The remaining play time will not be displayed for track number 16 or higher.
- If track number 16 or higher is programmed, during the program play, the total play time and the total remaining play time will not be displayed.
- When this unit is in the Playback Control mode ("PBC" is illuminated on the display), the currently selected time display mode cannot be changed to another.

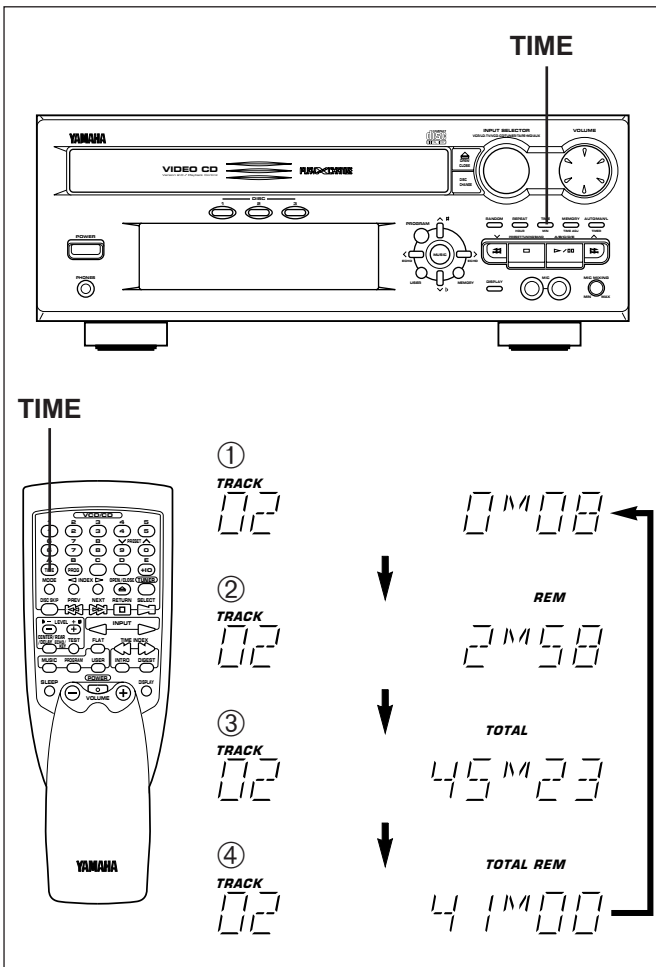



VIDEO CD PLAYER OPERATION

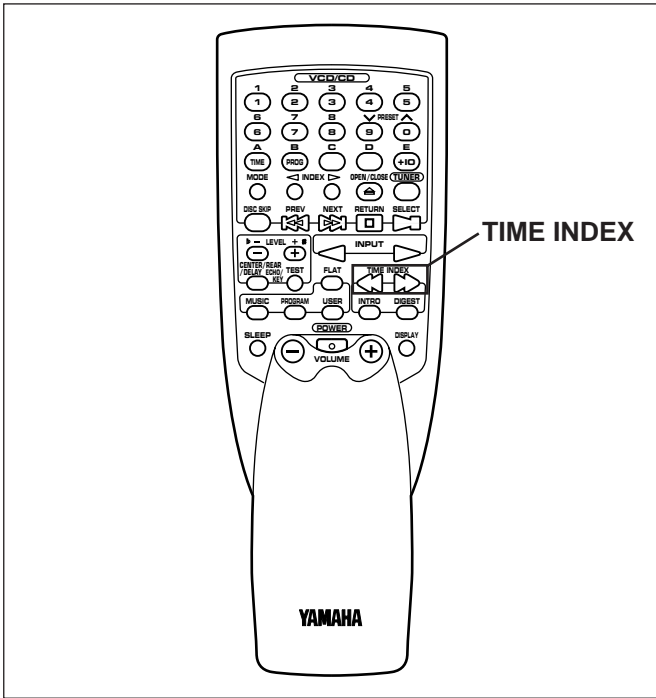

To skip through tracks or an entire disc forward or backward (for Video CDs only)

Pressing the TIME INDEX ◀ or ▶ button once allows you to skip through the track backward or forward respectively by the time shown on the display.

When you press a button several times in a short period of time, the time to skip changes on the display. Releasing the button moves the position by the displayed time before or after. The skip operation varies as follows:

- While you are playing back a disc, you can skip forward or backward through the entire disc.
- While you are playing back a Video CD, version 2.0 in the Playback Control mode, you can skip forward or backward through the selected track.

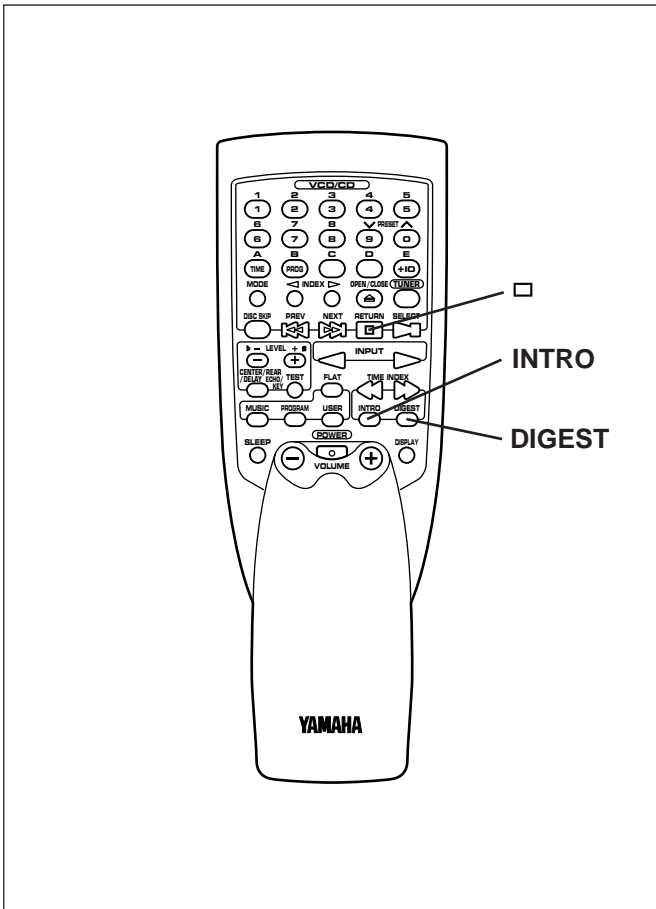

To get a quick overview of a track or a disc (for Video CDs only)

To watch scenes of a selected track on a Video CD

Press the DIGEST button.

To watch the beginning of all tracks on a Video CD

Press the INTRO button.

* You can watch up to nine screens at a time on the video monitor.

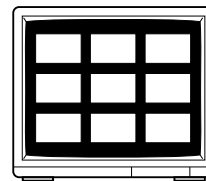

Notes

- These buttons can work only for playing back a Video CD.
- These buttons cannot work when playing back a Video CD, version 2.0 in the Playback Control mode. To make these buttons work, press and hold the stop □ button for more than 2 seconds to stop this unit.
- These DIGEST and INTRO operations repeat endlessly until you stop playback.
- The monitor can show up to nine screens at a time. The number of screens varies from disc to disc. There may be a case that the monitor can show one screen only as follows:
- These button cannot work in the program play and random play modes.

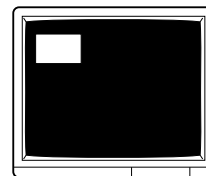

To cancel DIGEST and INTRO operations

Press the stop □ button.



PLAYBACK CONTROL OF VIDEO CD (Ver. 2.0)

This function is available for Video CDs, version 2.0 only. "PBC" will light up on the display when a version 2.0 disc is used.

The Playback Control differs with each disc. This section gives a basic explanation of Playback Control. Refer to the instruction manual for the disc for details.

Playback Control provides you with two types of new playback enjoyment.

Playback selection on a screen menu

You can select pictures, music and information to play back by selecting items on a screen menu. (Similar to having a conversation.)

Playback of high quality pictures

You can enjoy watching pictures which are four times higher in quality than moving pictures.

A Flowchart of Playback Control (as an example)

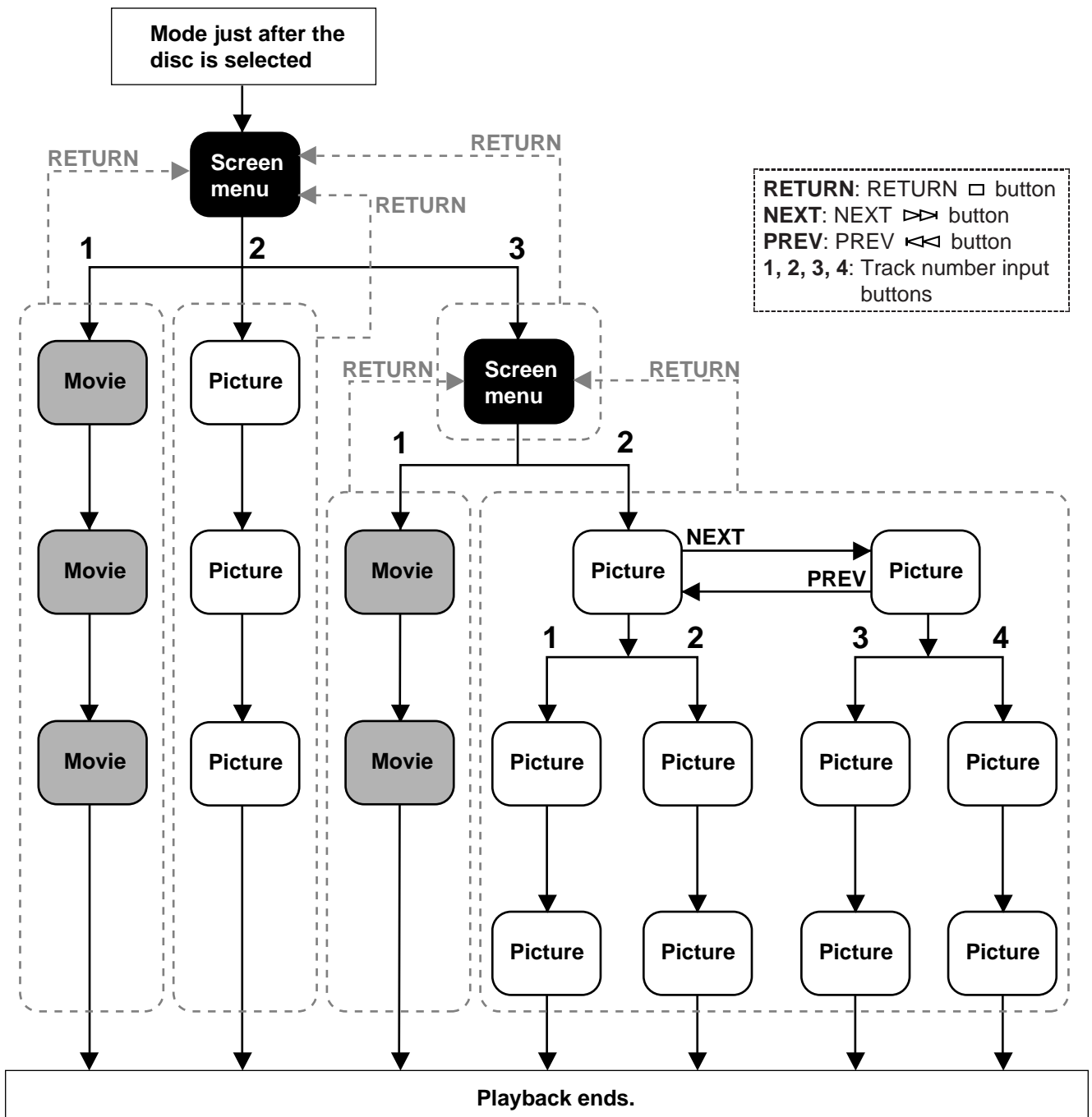



PLAYBACK CONTROL OF VIDEO CD (Ver. 2.0)

Basic operation

Use the remote control transmitter for making Playback Control operations.

Note

Disc playback in the Playback Control mode depends on the data of the disc used. So, according to the contents of disc, the following operating method may not be applied to the disc.

Be sure to refer to the instruction manual for the disc.

- 1 Stop this unit and select a Video CD (version 2.0) by pressing the DISC SKIP button on the remote control transmitter .
* "PBC" lights up on the display.
- 2 Press the SELECT button. A screen menu appears on the TV monitor.
* Some discs show several short movies sequentially instead of a menu.
- 3 Select the number of item you want to play back by using the track number input buttons.
* If the disc shows several short movies sequentially, press the SELECT button when a desired picture appears.
- 4 Playback starts, or another menu appears. If another menu appears, repeat step 3.
(Some discs have more than one screen menu.)
- 5 If "NEXT" or "▶▶" appears on the screen during playback, pressing the NEXT button will change to the next menu.

If "PREV" or "◀◀" appears on the screen during playback, pressing the PREV button will restore the previous menu.

Notes

- In the Playback Control mode, the TIME and REPEAT buttons are disabled.
- If this unit is stopped, the PROG, RANDOM, DIGEST and INTRO buttons can work even if this unit is in the Playback Control mode. In this state, pressing one of these buttons cancels the Playback Control mode.

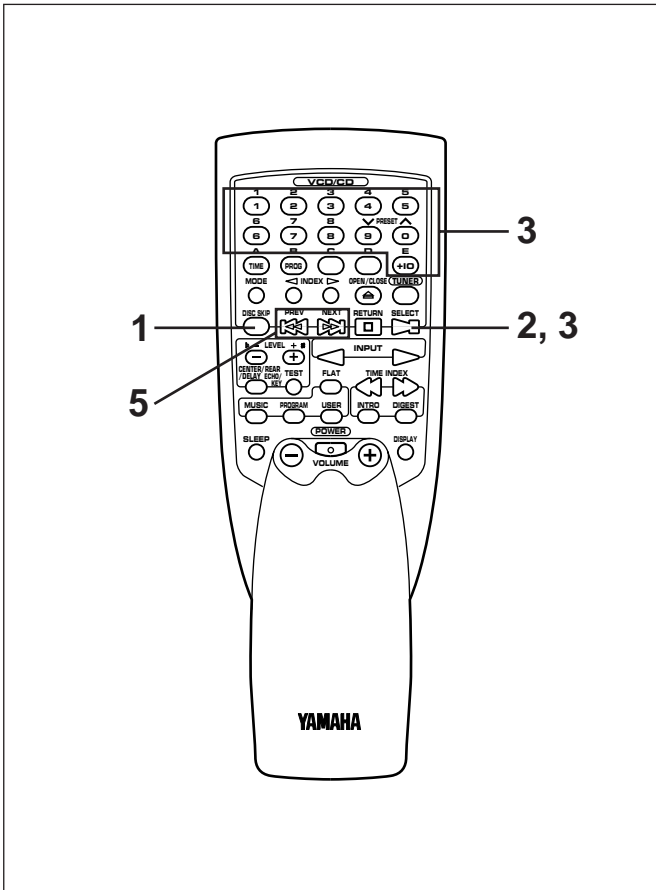



PLAYBACK CONTROL OF VIDEO CD (Ver. 2.0)

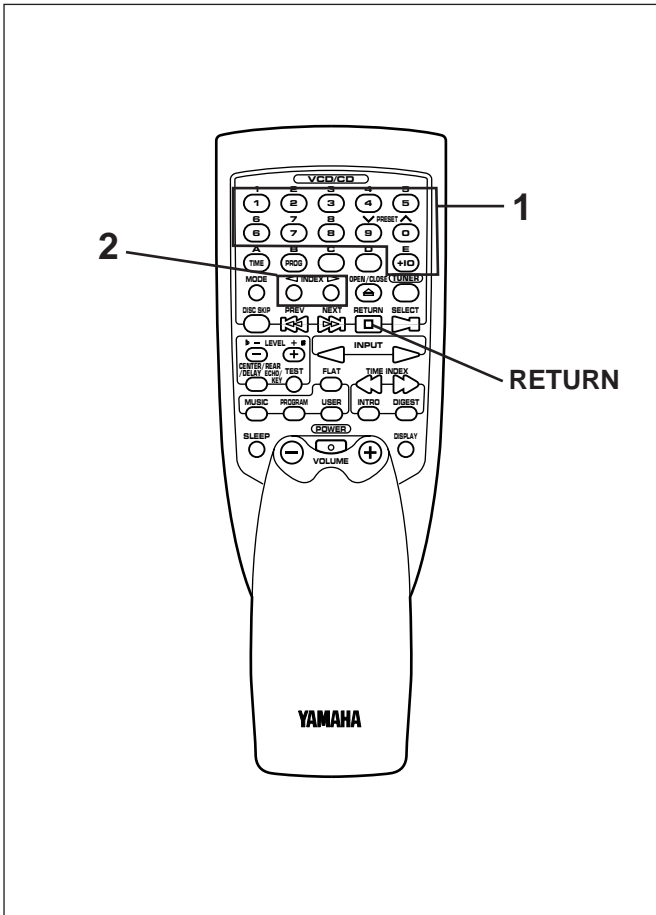

To stop playback

Press and hold the RETURN button for more than 2 seconds.

To return to a previous screen mode during playback

Press the RETURN button once.

* To return to the first screen mode, press the RETURN button repeatedly until the first screen mode appears.

If the disc has index numbers

If the currently selected disc includes index numbers, playback can be started from any desired index number.

- 1 Select a track which has index numbers by using the track number input buttons.
- 2 Pressing the INDEX < or INDEX > button once or more searches for and select any index number. Play starts from the point of selected index number.

To playback a Video CD (ver. 2.0) without Playback Control operation

Press the RETURN button when this unit is stopped. "PBC" disappears from the display, and this unit turns into a normal playback mode.

To restore the Playback Control mode again, press and hold the RETURN button for more than 2 seconds.

TUNING OPERATION

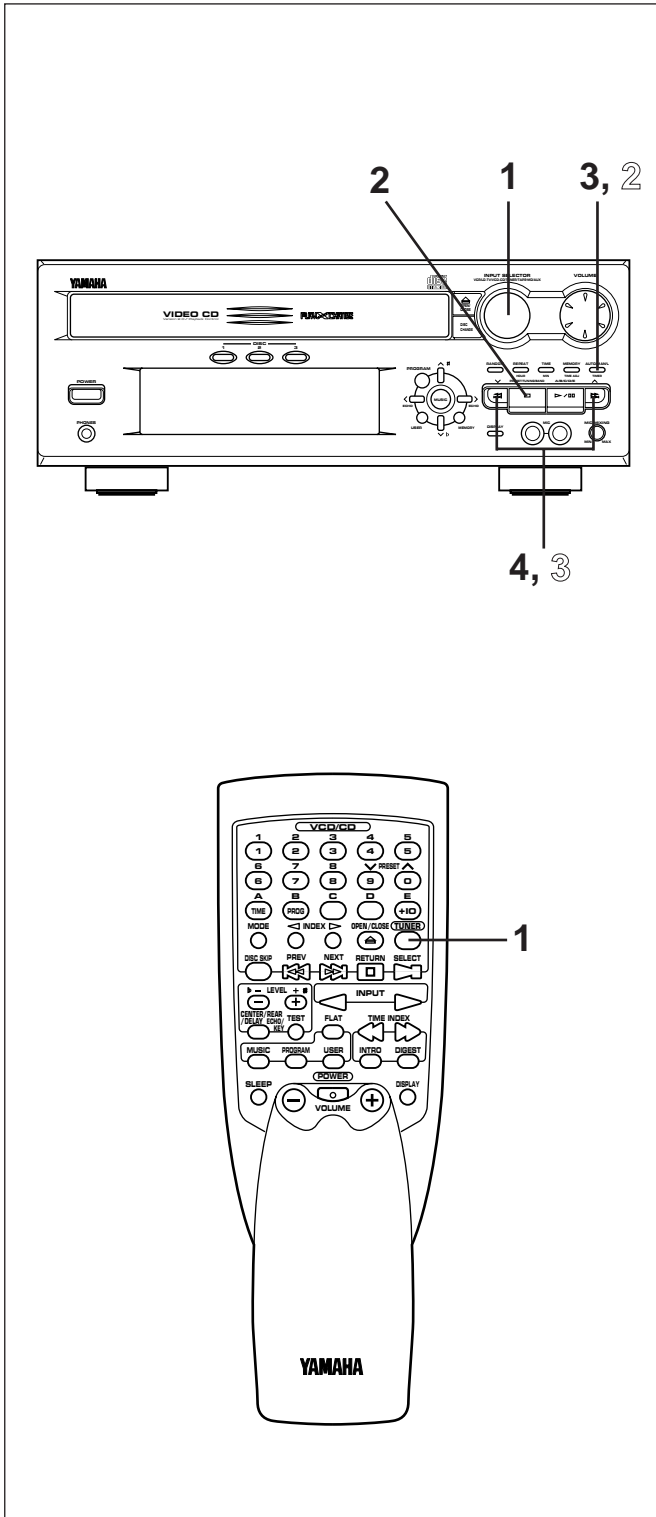

Normally, if station signals are strong and there is no interference, quick automatic-search tuning (Automatic tuning) is possible. However, if signals of the station you want to select are weak, you must tune to it manually (Manual tuning).

Automatic tuning

- 1 Select the tuner by turning the INPUT SELECTOR until "TUNER" appears on the display.
- 2 Select the reception band (FM or AM) by pressing the PRESET/TUNING/BAND button confirming it on the display.
 - * Do not select a preset tuning mode (Do not select a mode in which "PRESET" lights up on the display.)
- 3 Press the AUTO/MAN'L button so that "AUTO" appears on the display. (In this mode, stations are received in stereo or monaural automatically.)
- 4 Press the ^ button to tune to a higher frequency, or press the v button to tune to a lower frequency. (When tuned in to a station, "TUNED" will light up on the display.)
- 5 If the station where tuning search stopped is not the desired one, follow step 4 again.
 - * If the tuning search does not stop at the desired station, change to the Manual tuning method as described below.
 - * STEREO indicator will light up when an FM stereo broadcast with sufficient signal strength is received.

Manual tuning

- 1 Follow steps 1 and 2 of the Automatic tuning method.
- 2 Press the AUTO/MAN'L button so that "AUTO" disappears from the display. (In this mode, stations are received in monaural.)
- 3 Press and hold the ^ button to tune to a higher frequency, or press and hold the v button to tune to a lower frequency. Release it just before reaching the desired frequency, and then press it repeatedly until the desired frequency appears. (When tuned in to a station, "TUNED" will light up on the display.)

Note

If you tune in to an FM station manually, it is received in monaural automatically to increase the signal quality.

Note

Pressing the TUNER input selector button on the remote control transmitter switches the tuner from a normal tuning mode to a preset tuning mode and vice versa, or from FM to AM mode and vice versa.



TUNING OPERATION

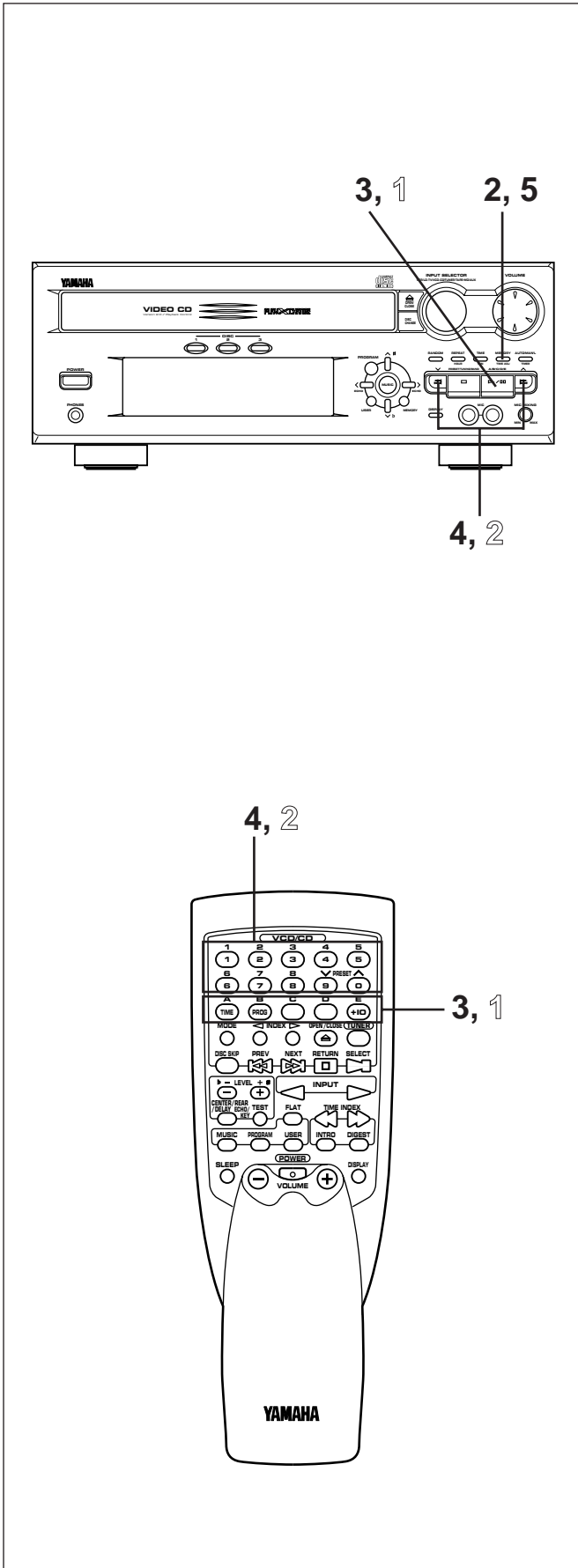

Preset tuning

This unit can store station frequencies selected by tuning operation. With this function, you can select any desired station by only calling the corresponding preset station number. Up to 40 stations (8 stations x 5 groups) can be stored.

To store stations

(Example: To store a station to A1)

- 1 Tune in to a desired station.
(Refer to the previous page for tuning procedure.)
- 2 Press the tuner MEMORY button.
* "MEMORY" and "PRESET" will flash on the display for about 5 seconds.
- 3 Select a desired group (A – E) of preset stations by pressing the A/B/C/D/E button confirming it on the display, before "MEMORY" goes out.
(In this case, select group A.)
- 4 Select a preset station number by pressing the \vee or \wedge button repeatedly before "MEMORY" goes out.
(In this case, select "1".)
- 5 Within about 5 seconds, press the tuner MEMORY button again.

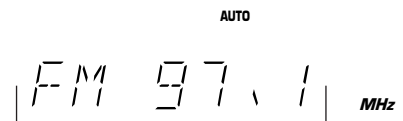

The currently displayed station has been programmed to A1.

- * In the same way, program other stations to A2, A3 ... A8.
- * You can program more stations to the preset station numbers of other groups in the same way by selecting other groups in step 3.

To recall a preset station

- 1 Select a group of preset stations by pressing the A/B/C/D/E button.
- 2 Select the desired preset station number by pressing the \vee or \wedge button repeatedly.

Notes

- A new setting can be programmed in place of the former one.
- For presets the setting of the AUTO/MAN'L button is stored along with the station frequency.

For easier operation

By using the preset station number buttons and the A,B,C,D,E selector buttons on the remote control transmitter, a preset station number and a group can be selected directly.

TUNING OPERATION

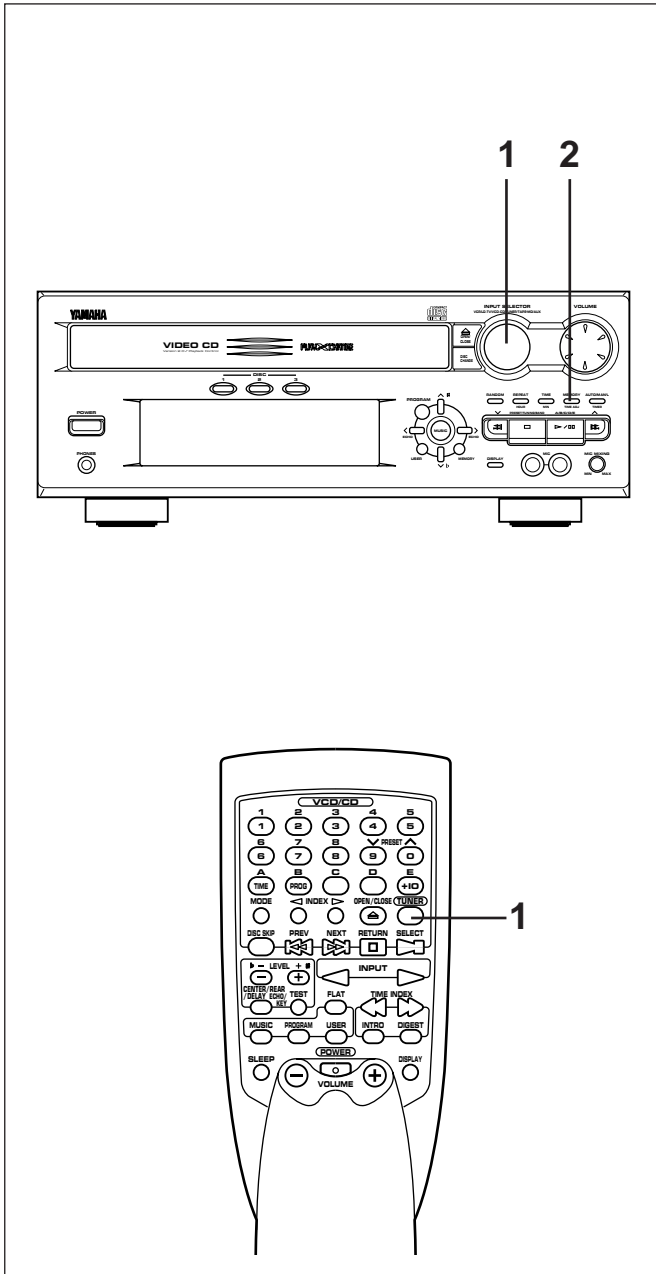

Automatic preset tuning

You can also make use of an automatic preset tuning function. By this function, this unit performs automatic tuning and stores stations with strong signals sequentially. Up to 40 stations are stored automatically in the same way as in the manual preset tuning method on the previous page.

- 1 Select the tuner by turning the INPUT SELECTOR until "TUNER" appears on the display.
- 2 Press and hold the tuner MEMORY button for about 2 seconds.
 - * The MEMORY and AUTO indicators will flash.

This unit performs automatic tuning and searches FM and AM stations in that order. Received stations are programmed to A1, A2 ... A8 sequentially.

When the automatic preset tuning is completed

The display shows the frequencies of the first preset station (stored to A1).

Check the contents and the number of preset stations by following the procedure of the section "To recall a preset station" on the previous page.

To recall a preset station

Simply follow the procedure of the section "To recall a preset station" on the previous page.

Notes

- The automatic preset tuning search will be performed through all frequencies until 40 stations are stored. If the number of received stations is less than 40, the search will stop after searching all frequencies.
 - * Since FM stations are searched for first, there may be a case that 40 preset stations are occupied by FM stations only.
- With this function, only stations with sufficient signal strength are stored automatically. If the station you want to program is weak in signal strength, tune in to it with the Manual tuning method (in monaural) and program it by following the procedure of the section "To store stations" on the previous page.
- You can replace a preset station by another FM or AM station manually by simply following the procedure of the section "To store stations" on the previous page.

Memory back-up

The memory back-up circuit prevents the programmed data from being lost even if the AC supply lead is disconnected from the AC outlet or the power is cut due to temporary power failure. If, however, the power is cut for more than one week, the memory may be erased. If so, it can be re-programmed by simply following the Preset tuning steps.

OPERATING EXTERNAL UNITS CONNECTED WITH THIS UNIT

To listen to or watch a source on an external unit connected with this UNIT

- 1 Select the position of input source (TAPE-MD, AUX, VCR or LD-TV) you will play back by turning the INPUT SELECTOR until the corresponding name appears on the display.
* The names of input source positions correspond with the names of terminals to connect with external units on the rear of this unit.
- 2 Play back the source.
(For a video source, turn the monitor TV on.)
- 3 Adjust the volume to a desired level by using the VOLUME control.
If you prefer, use the graphic equalizer and/or the sound field processor built into this unit.

To record a source to tape

Not only a source played back on this unit, but also a source played back on an external unit can be recorded by the tape deck, VCR, DAT, etc. connected with this unit.

- 1 Select the source to be recorded by turning the INPUT SELECTOR.
- 2 Play back the source and then turn the VOLUME control up to confirm the input source.
- 3 Begin recording on the tape deck or VCR etc. connected with this unit.

Note

If the built-in graphic equalizer and/or sound field processor is used, its effect is recorded along with the source when you make recording on the recording unit connected to the TAPE-MD terminals on the rear of this unit. However, the effect of the graphic equalizer and/or sound field processor cannot be recorded when you make recording on the external recording unit connected to the VCR terminals on the rear of this unit.

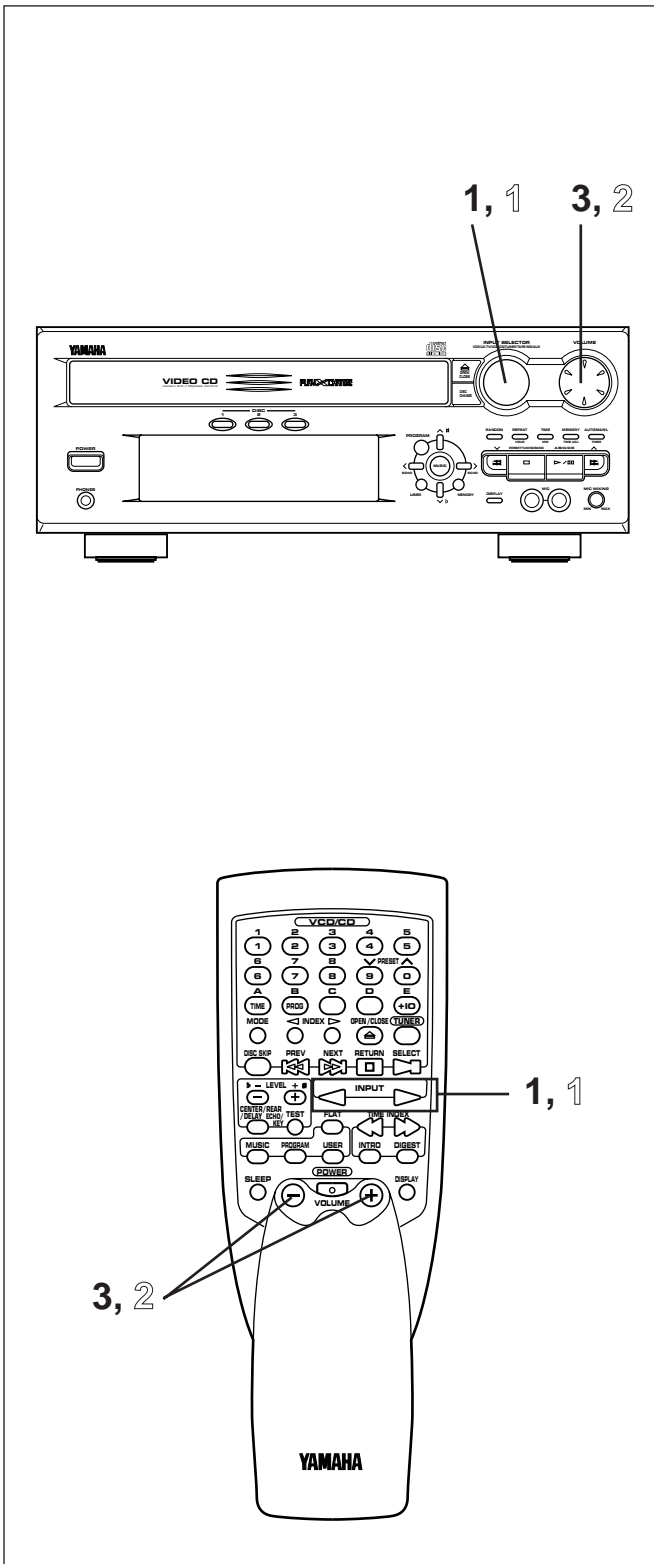

USING GRAPHIC EQUALIZER

The built-in graphic equalizer presents you with the pleasure of listening to music with various sound effects. This unit provides 4 preset equalizer modes as listed right. You can enjoy listening to music with a desired sound effect by selecting one of these modes. In addition, the built-in 5 band graphic equalizer allows you to adjust the equalizer pattern to create an effect for your desired sound taste.

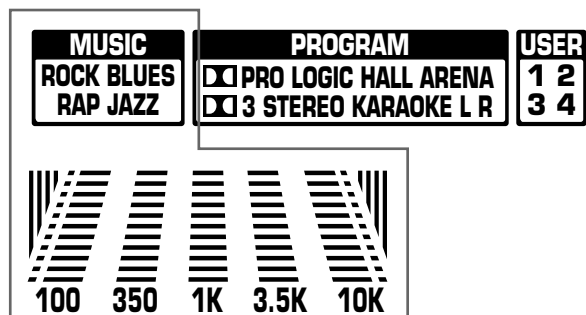

Preset graphic equalizer modes (MUSIC)

Mode	Feature
ROCK	High and low frequencies are emphasized. This mode is suitable for reproducing dynamic and powerful sounds of rock music etc.
BLUES	Low and medium frequencies are moderately emphasized. This mode is suitable for music with a blue feeling.
RAP	Low and mid-high frequencies are emphasized so that vocals become well-modulated. This mode is suitable for rap music etc.
JAZZ	Medium frequencies for vocals, piano, sax, etc. are emphasized. High and low frequencies are also emphasized moderately.

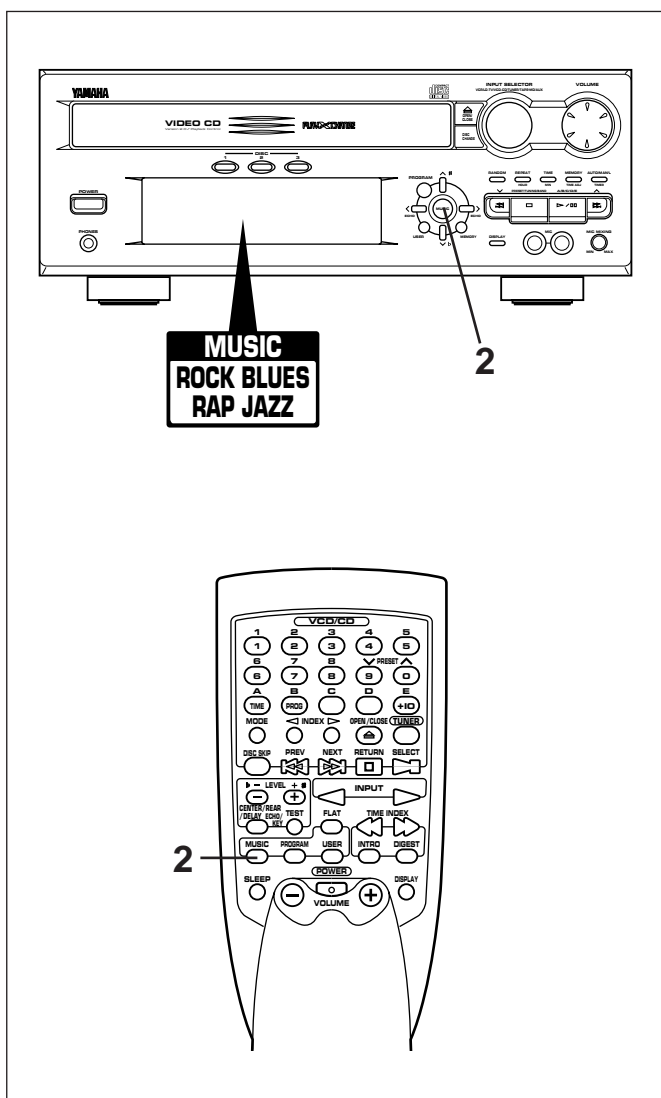

Listening to the music with a preset equalizer effect

- 1 Play back a source. (For source playback, refer to page 14–27.)
- 2 Press the MUSIC button once or more so that the name of a desired mode appears on the preset equalizer mode indicator.
 - * Whenever you press the MUSIC button, the preset mode changes and is displayed as follows.

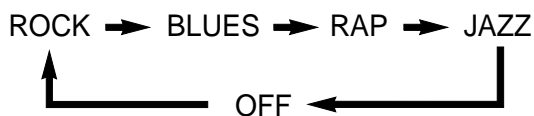

* The equalizer pattern of the selected mode is shown on the graphic equalizer level indicators.

USING GRAPHIC EQUALIZER

Adjusting the graphic equalizer for your desired sound taste

The 5 band graphic equalizer allows you to adjust the level for each frequency band.

* Make adjustment by monitoring the equalizer level indicators on the display.

- 1 Play back a source. (For source playback, refer to page 14–27.)
- 2 Press the equalizer control < or > button once or more to select the frequency band to which you will adjust the level.
 - * The selected frequency band is shown on the display.
 - * The scale bar of the selected frequency band on the graphic equalizer level indicators will flash.
- 3 Press the equalizer control ^ or v button once or more to adjust the level.
- 4 In the same way, make adjustment for other frequency band.

Note

If the KARAOKE (including L R, L ONLY and R ONLY) program is selected, cancel it or select another sound field program.

Turning the equalizer to “flat” (the state with no equalization applied)

By one of the following methods, the settings of preset graphic equalizer mode (MUSIC) and sound field program (PROGRAM) are turned off and the equalizer pattern is turned to “flat”.

- Press the FLAT button on the remote control transmitter.
 - * Pressing the FLAT button once more will restore the state before the equalizer was turned to “flat”.
- Press the MUSIC button and the PROGRAM button on the front panel at the same time.
 - * There is no way to restore the state before the equalizer was turned to “flat”.

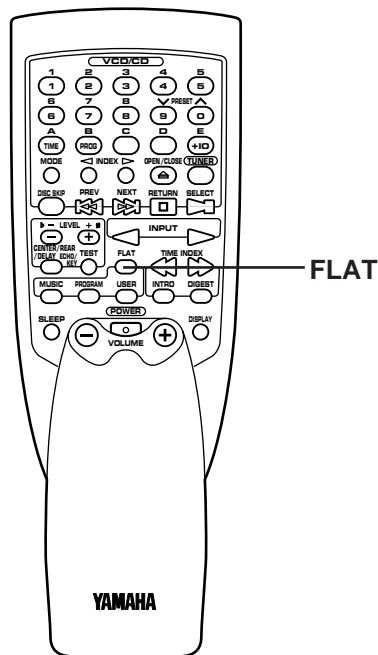
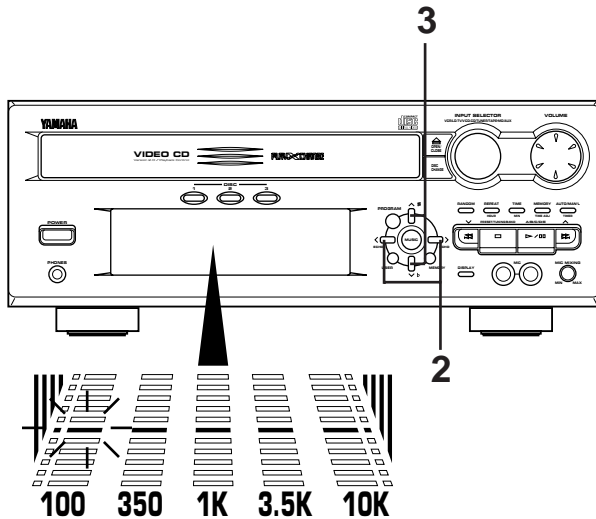

USING SOUND FIELD PROCESSOR

The Sound Field Processor built into this unit presents you with the ambience of an actual concert hall etc. by adding effects as sonic reflections or reverberations that create the sound environment of a hall etc. This unit provides preset sound field programs shown below. You can enjoy an excellent audio sound field by selecting one of them, and adding desired adjustments.

This unit incorporates a Dolby Pro Logic Surround decoder for multi-channel sound reproduction of Dolby Surround encoded video sources. The operation of the Dolby Pro Logic Surround decoder can be controlled by selecting a corresponding sound field program.



Brief Overview of Sound Field Programs

PROGRAM	FEATURE
<input checked="" type="checkbox"/> PRO LOGIC	This program is used for playback of sources encoded with Dolby Surround. Sounds are reproduced as movie creators designed by using five speakers. You can experience the dramatic realism and impact of a movie theater.
<input checked="" type="checkbox"/> 3 STEREO	This program is effective not only for playback of sources encoded with Dolby Surround, but also for sources not encoded with Dolby Surround or TV programs with 2-channel stereo sound. With this program, 2-channel stereo sound is converted into 3-channels (left front, center and right front), so the dialogs are emphasized on the center position by the use of the center speaker. As no sound is output from the rear speakers, this program is also effective in a simple Audio/Video system without rear speakers.
HALL	In this program, the center will appear to be deep behind the front speakers, creating an expansive large hall ambience. Orchestra and opera music are suited for this sound field.
ARENA	This program simulates the sound environment of a big hall with long reverberation time and many reflections of high frequencies.
KARAOKE L R KARAOKE L KARAOKE R KARAOKE	These are audio output modes useful for singing Karaoke. (Refer to page 36 for details.)

USING SOUND FIELD PROCESSOR

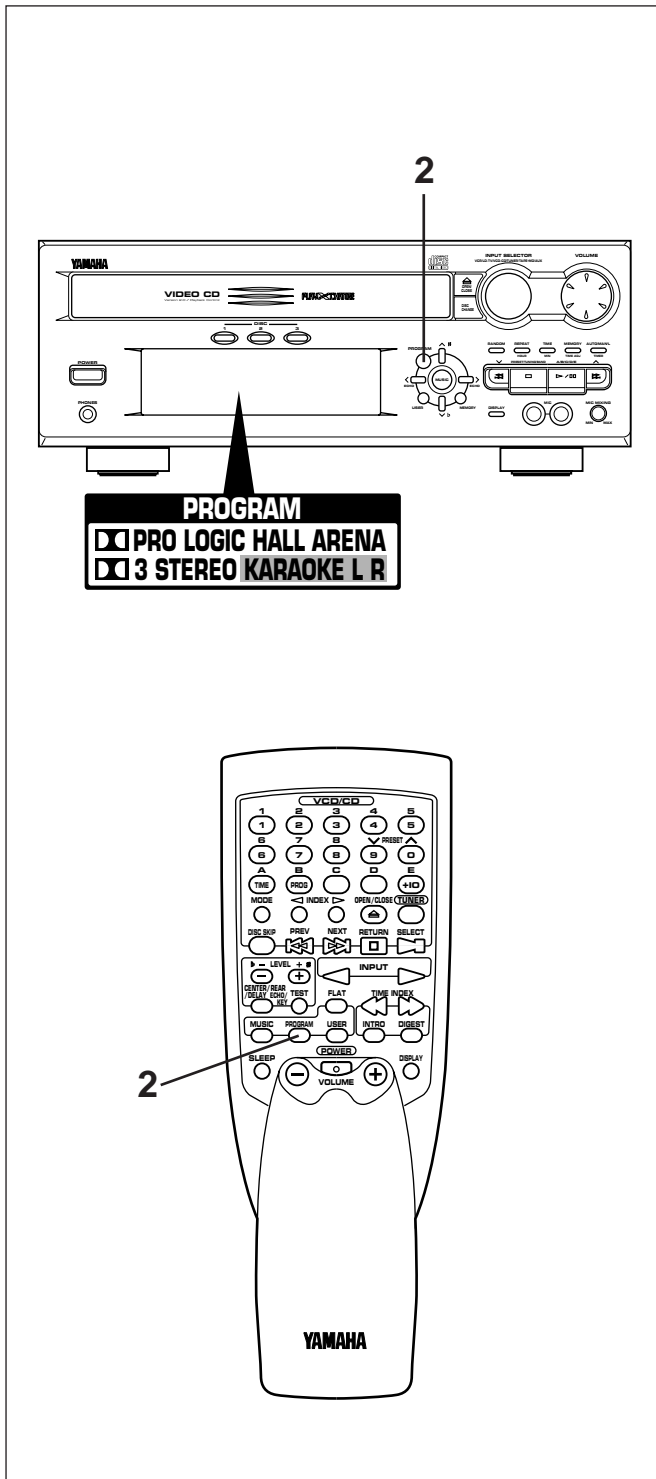

Listening to the music with a sound field effect

- 1 Play back a source. (For source playback, refer to page 14–27.)
- 2 Press the PROGRAM button once or more so that the name of a desired program appears on the sound field program indicator.
* Whenever you press the PROGRAM button, the program changes and is displayed as follows.

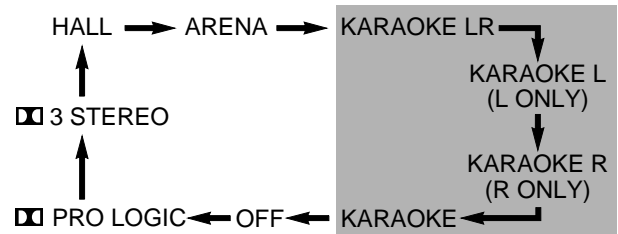

* Programs on the shaded areas are audio output modes useful for singing Karaoke. (Refer to page 36 for details.)

- 3 If desired, adjust the delay time and the output level of each speaker. (For details, refer to the corresponding descriptions on page 33–34.)

Notes

- When HALL or ARENA is selected, no sound is heard from the center speaker.
- When a monaural sound source is played with DOLBY PRO LOGIC or DOLBY 3 STEREO, no sound is heard from the front speakers and the rear speakers. Sound is heard only from the center speaker. For DOLBY PRO LOGIC only, however, if the center channel mode is in "PHANTOM", the front speakers output the sound of the center channel.

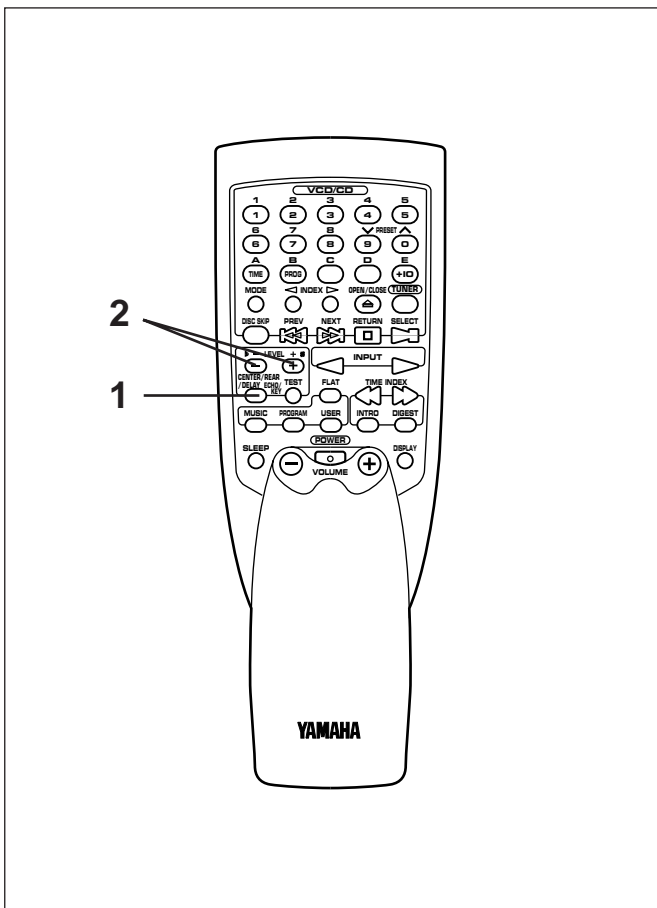

Adjusting CENTER LEVEL

If desired, you can adjust the sound output level of the center speaker even if the output level is already set in "SPEAKER BALANCE ADJUSTMENT" on page 12–13.

Control range : +10 to –21

- 1** Press the CENTER/REAR/DELAY selector button once or more so that "CENT" appears on the display.
- 2** By continuously pressing the LEVEL control + or – button, the level value changes continuously.

Notes

- This adjustment can be made only when the sound field program DOLBY PRO LOGIC or DOLBY 3 STEREO is selected.
- Once the output level is adjusted, the level value will be the same in the DOLBY PRO LOGIC and DOLBY 3 STEREO programs.
- If the center channel mode is in the "PHANTOM" position, the sound output level of the center speaker cannot be adjusted. This is because in this mode, the center sound is automatically output from the left and right front speakers.

Adjusting REAR LEVEL

If desired, you can adjust the sound output level of the rear speakers even if the output level is already set in "SPEAKER BALANCE ADJUSTMENT" on page 12–13.

Control range : +10 to –21

- 1** Press the CENTER/REAR/DELAY selector button once or more so that "REAR" appears on the display.
- 2** By continuously pressing the LEVEL control + or – button, the level value changes continuously.

Notes

- This adjustment can be made when a sound field program except DOLBY 3 STEREO is selected.
- Adjustment can be made to DOLBY PRO LOGIC, HALL and ARENA individually.

USING SOUND FIELD PROCESSOR

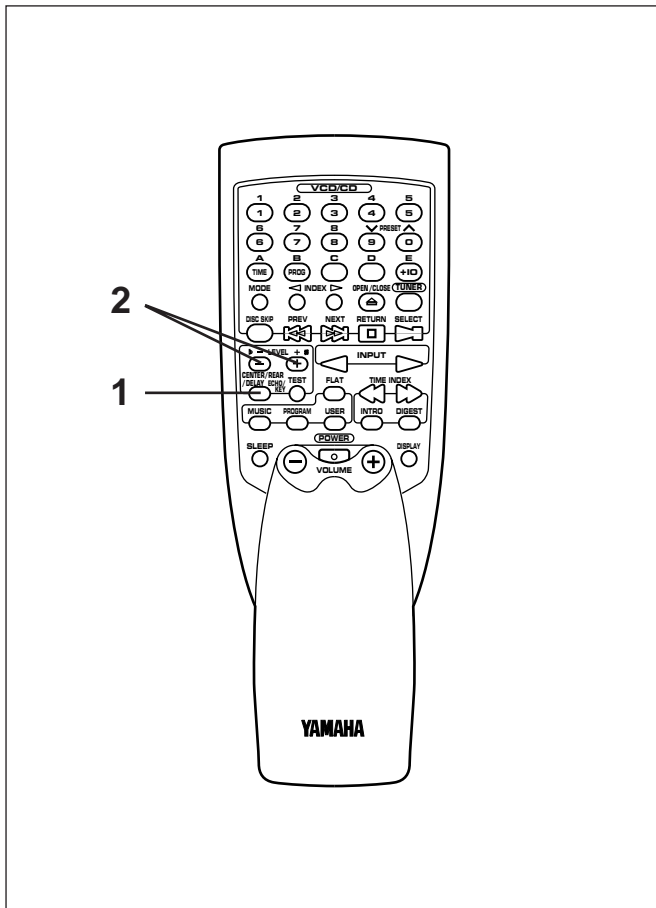

Adjusting DELAY TIME

You can adjust the time difference between the beginning of the sound from the main speakers and the beginning of the effect sound from the rear speakers.

This adjustment can be made to all programs (except DOLBY 3 STEREO) individually.

Control range

PRO LOGIC : 15, 20, 25, 30 milliseconds

HALL, ARENA : 15, 20, 25, 30, 40, 50 milliseconds

- 1 Press the CENTER/REAR/DELAY selector button once or more so that "DELAY" appears on the display.

DEL 20ms

- 2 By continuously pressing the LEVEL control + or – button, the value changes continuously. The value stops changing momentarily at the preset point.

DEL 25ms
Adjustable

Notes

- When DOLBY 3 STEREO is selected, this adjustment cannot be made.
- Adding too much delay will cause an unnatural effect with some sources.
- When the LEVEL control button is pressed, sound is momentarily interrupted.

Note

The values of the delay time, center level and rear level you set the last time will remain memorized even when this unit is in the standby mode.

However, if the power cord is kept disconnected for more than one week, these values will be automatically changed back to the original factory settings.

STORING YOUR OWN PROGRAMS

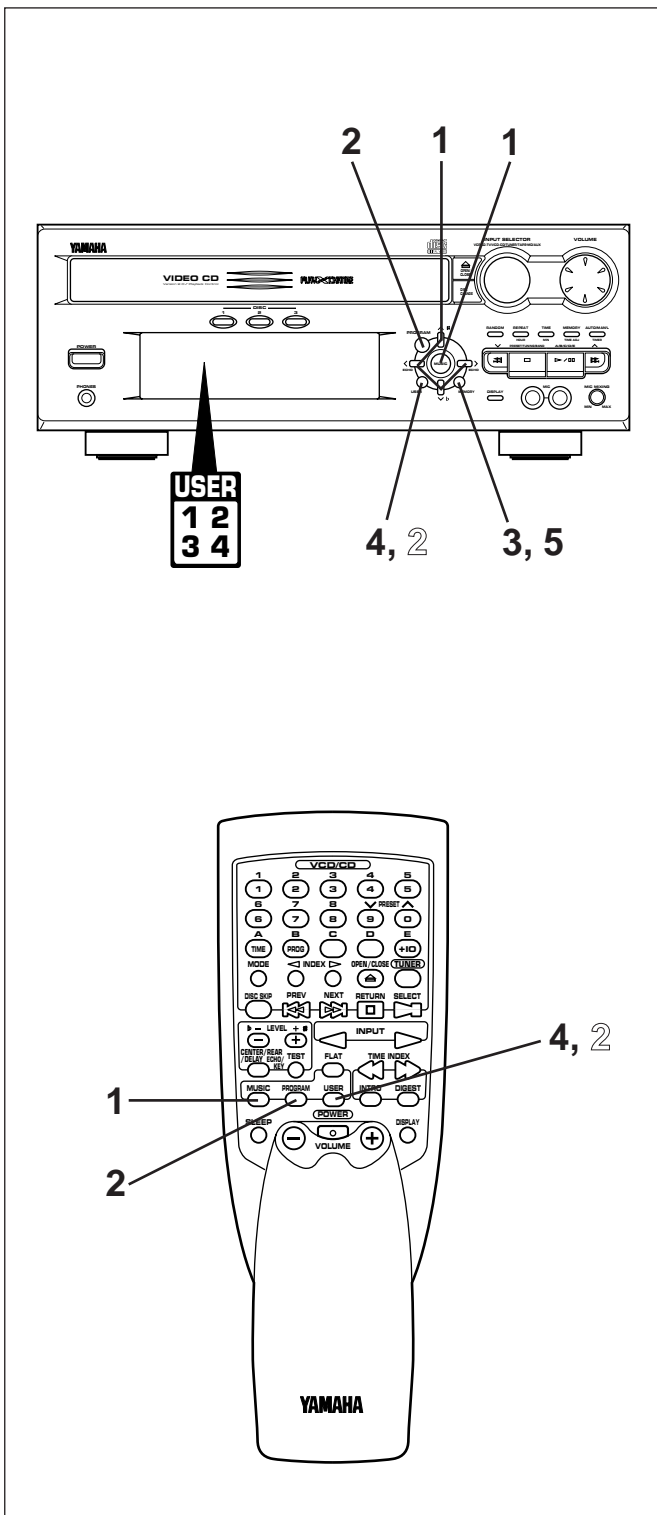

Your favorite pair of any equalizer mode (or an equalizer pattern of your own adjusting) and any sound field program can be stored as a user program. Up to 4 pairs can be stored as desired.

To store

- 1 Select a desired equalizer mode by pressing the MUSIC button.
* If desired, adjust the equalizer as you prefer by using the equalizer control buttons.
- 2 Select a desired sound field program by pressing the PROGRAM button.
- 3 Press the user program MEMORY button.
* "1" will flash on the user program number indicator and the MEMORY indicator will flash for about 5 seconds.
- 4 Select the user program number (1, 2, 3 or 4) to which you will store the selected modes by pressing the USER button once or more before "1" stops flashing.
* Whenever you press the USER button, the user program number changes and is displayed as follows.

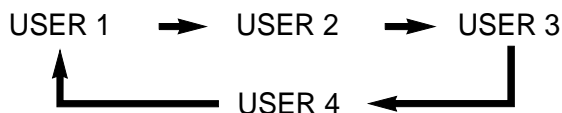

- 5 Press the user program MEMORY button before the number selected in step 4 stops flashing.

* In the same way, store other pairs to other three user positions.

* It is also a good idea to store only an equalizer pattern of your own adjusting (without storing any sound field program).

Notes

- A new program can be stored in place of the former one.
- In step 4 or 5, if the user program number indicator stops flashing before operation, return to step 3.

To recall a user program

- 1 Play back a source. (For source playback, refer to page 14–27.)
- 2 Press the USER button once or more so that the user program number you want to recall lights up.
* Whenever you press the USER button, the user program number changes and is displayed as follows.

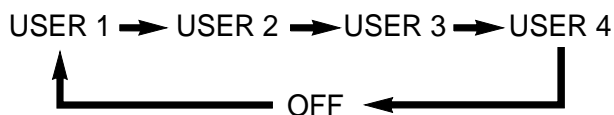

KARAOKE OPERATION

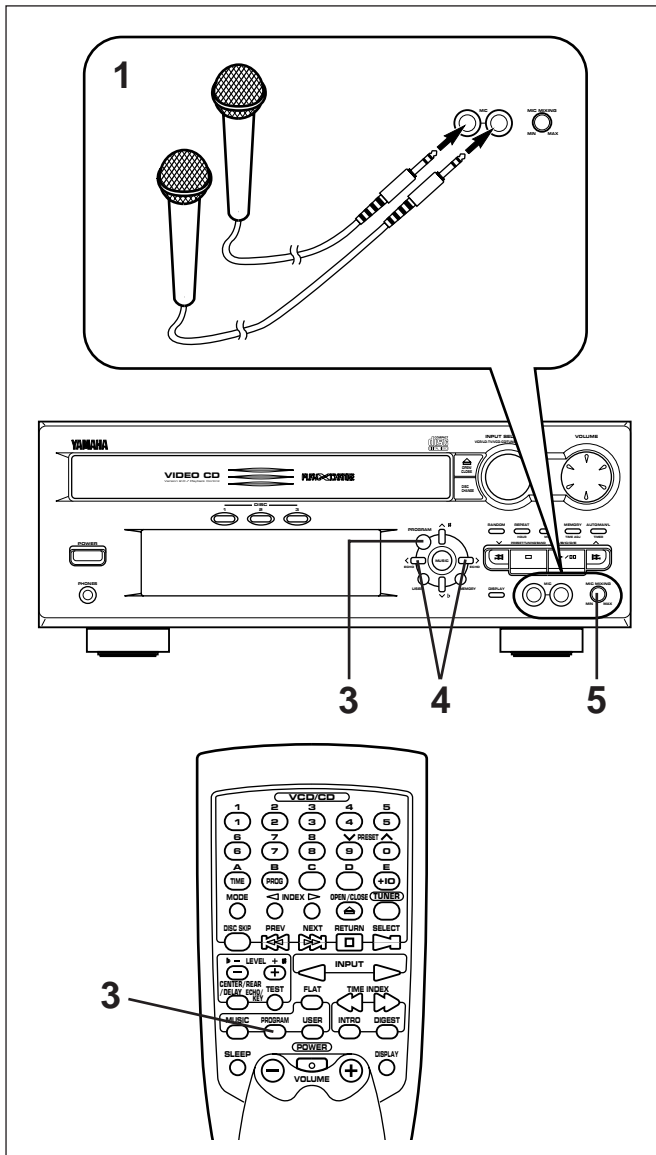

Singing karaoke

This unit allows you to enjoy singing karaoke by using not only a source for karaoke use but also any normal audio source.

- 1 Connect one or two microphones to the MIC jack(s) on the front panel.
- 2 Play back a source. (For source playback, refer to page 14–27.)
- 3 If necessary, select a karaoke mode (KARAOKE L R, KARAOKE L, KARAOKE R or KARAOKE) by pressing the PROGRAM button once or more so that the corresponding name appears on the sound field program indicator. For descriptions of the karaoke modes, see the list below.
- 4 If desired, adjust the level of echo effect and key level of the source currently played back (For details, see the next page.)
- 5 While singing, adjust the mixing level of singing voice by turning the MIC MIXING level control.

To cancel the karaoke mode

Press the PROGRAM button so that “KARAOKE L R”, “KARAOKE L”, “KARAOKE R” or “KARAOKE” disappears from the sound field program indicator.

Karaoke modes (PROGRAM)

	Mode	Feature
For a karaoke source (without vocals)	KARAOKE L R	Signals on the left channel and the right channel are output from the left and right speakers respectively. Selecting this mode is suitable for singing karaoke by using a source which contains background music and no vocal.
For a multisound source	KARAOKE L	Only signals on the left channel of the source are output from the left and right speakers. When using a karaoke source which contains both background music and original vocals on the right channel and background music only on the left channel, selecting this mode is suitable for singing karaoke.
	KARAOKE R	Only signals on the right channel of the source are output from the left and right speakers. When using a karaoke source which contains both background music and original vocals on the left channel and background music only on the right channel, selecting this mode is suitable for singing karaoke.
For a normal source	KARAOKE	Medium frequencies of the source sound (vocals etc.) are attenuated. Select this mode when you sing karaoke using a normal audio source with vocals. Note There may be a case that vocals cannot only be attenuated effectively according to a source.

Note
When using a multisound source for Karaoke use, make sure to select the KARAOKE L or KARAOKE R mode. If the KARAOKE mode is selected, depending on a source, sound may become unnatural.

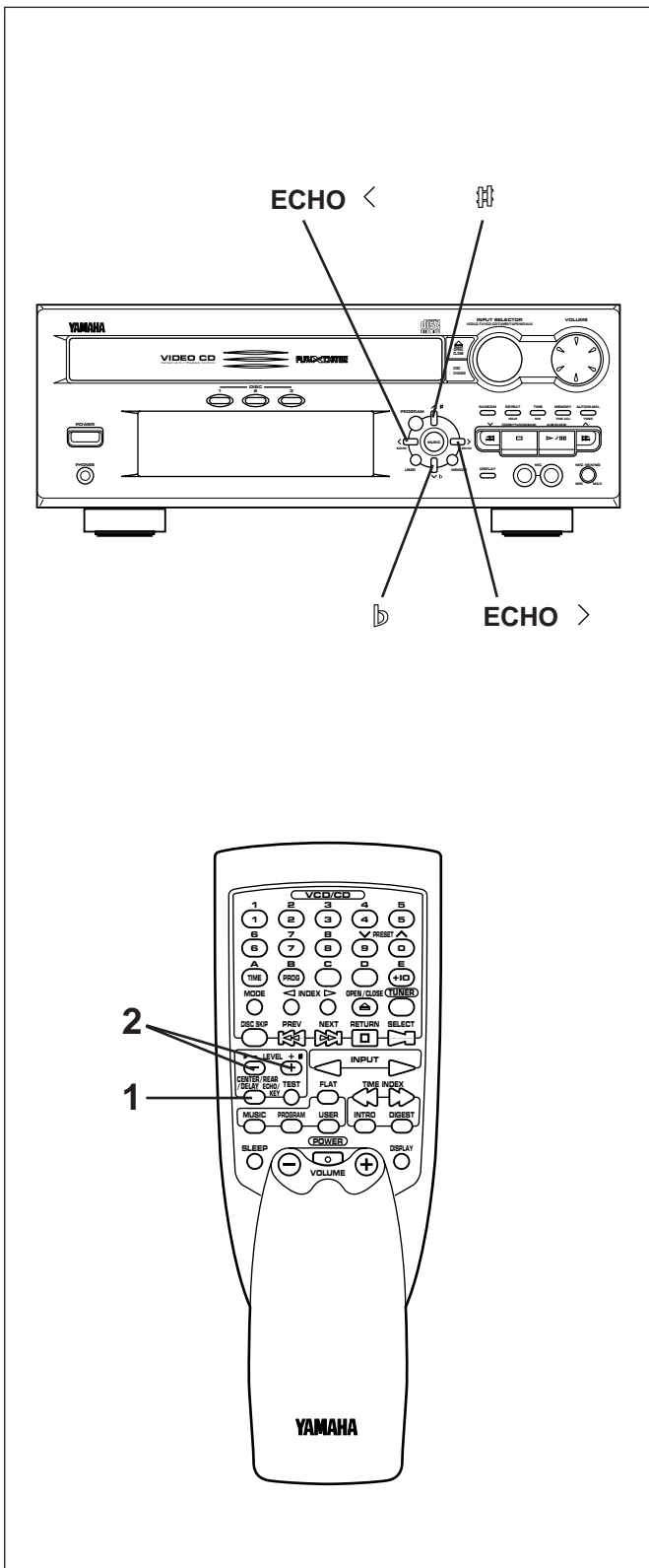

Adjusting the level of echo effect

You can adjust the level of echo effect applied to the sound input from the microphone(s).

Control range: MIN, 1–9, MAX

On the front panel:

Press the ECHO > button once or more to increase the level.
Press the ECHO < button once or more to decrease the level.

On the remote control transmitter:

- 1 Press the ECHO/KEY selector button once or more so that "ECHO" appears on the display.
- 2 Press the LEVEL + button to increase the level.
Press the LEVEL – button to decrease the level.

Notes



- This adjustment can be made only when a Karaoke mode (KARAOKE L R, KARAOKE L, KARAOKE R or KARAOKE) is selected.
- Echo effect is available even when a Karaoke mode is not selected.

Adjusting key level of the source currently played back

The key level adjustment can be made only when the Video CD player is selected as the source.

Control range: –6 to 6

On the front panel:

Press the  button once or more to increase the level.
Press the  button once or more to decrease the level.

On the remote control transmitter:

- 1 Press the ECHO/KEY selector button once or more so that "KEY" appears on the display.
- 2 Press the LEVEL + button to increase the level.
Press the LEVEL – button to decrease the level.

Notes

- This adjustment can be made only when the KARAOKE L R, KARAOKE L or KARAOKE R mode is selected.
- You can change the key level even while playing back a still picture (on a Video CD) though it is not effective until the playback of still picture end

To reset the key level to ±0

- Turn this unit into the standby mode.
- Press the PROGRAM button or the USER button (except when storing a new user program) on the front panel.
- Turn the built-in equalizer to "flat". (See page 30 for details.)

HOW TO USE THE BUILT-IN TIMER

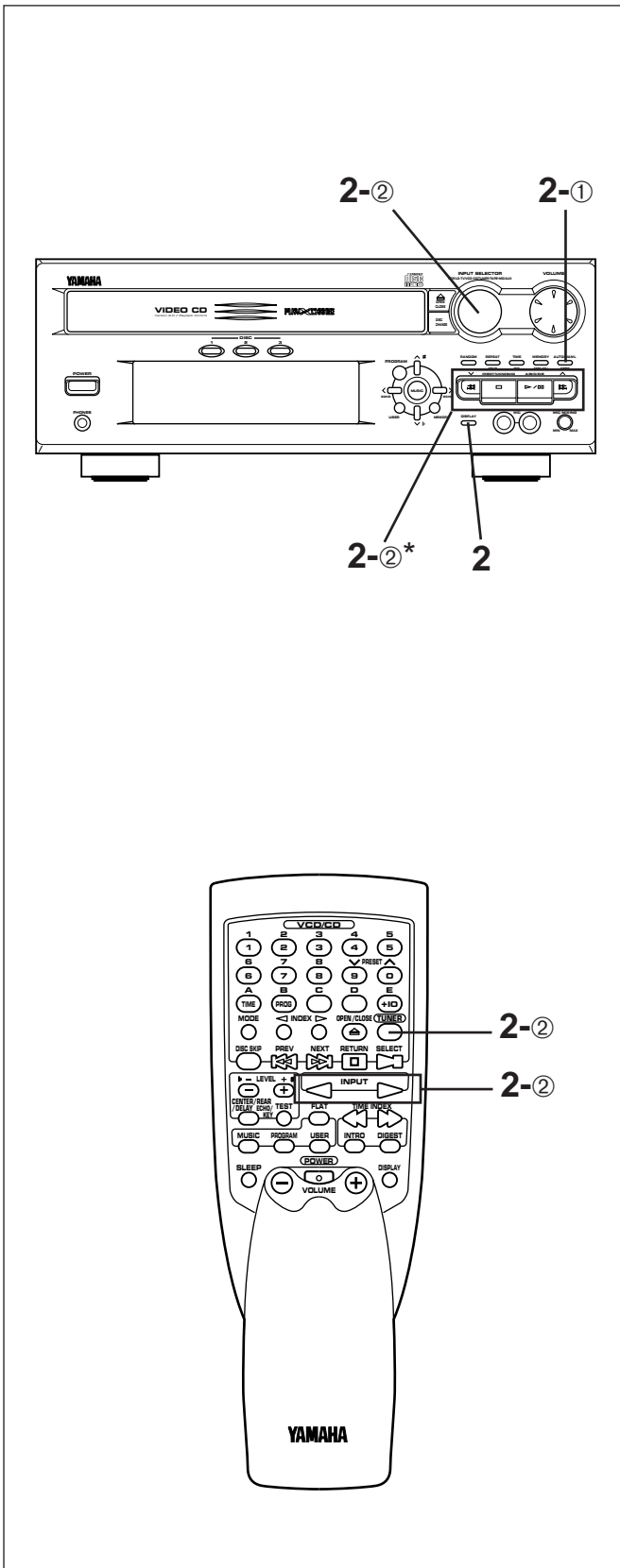

Timer play

By using the built-in timer, you can set the time when the unit turns on and a source begins playing automatically, and the time when the unit turns into the standby mode automatically.

- 1 Prepare the source to be played.

For tuner:

Tune in to the station you will listen to.

For Video CD player:

Load a disc on the disc table. If more than one disc are loaded on the disc table, select the disc by using the DISC selector buttons or the DISC SKIP button.

- 2 Press the DISPLAY button. Whenever the DISPLAY button is pressed, the display mode changes as follows. On each mode, make a setting for the timer play, following the setting procedure described below.

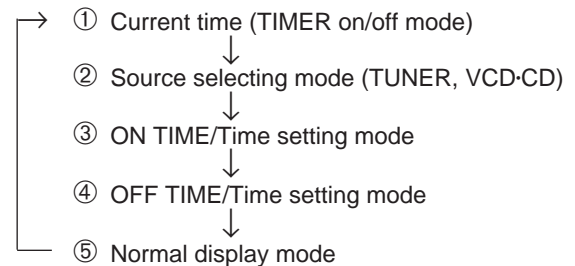

Note

The display mode will be changed to the next mode after about 8 seconds elapse in turn automatically. If the mode is changed before the setting is completed, call the mode again by pressing the DISPLAY button once or more.

Setting procedure:

- ① **Current time**
Check to be sure that the current time is correct, and press the TIMER button so that "TIMER" lights up on the display.
- ② **Source selecting mode**
Select the source (TUNER or VCD-CD) to be played turning the INPUT SELECTOR.
* If "TUNER" is selected, soon it is changed to the frequency display mode. In this mode, you can select the station to listen to with the timer play by using the PRESET/TUNING/BAND selector button, A/B/C/D/E button and ^ / v buttons.

HOW TO USE THE BUILT-IN TIMER

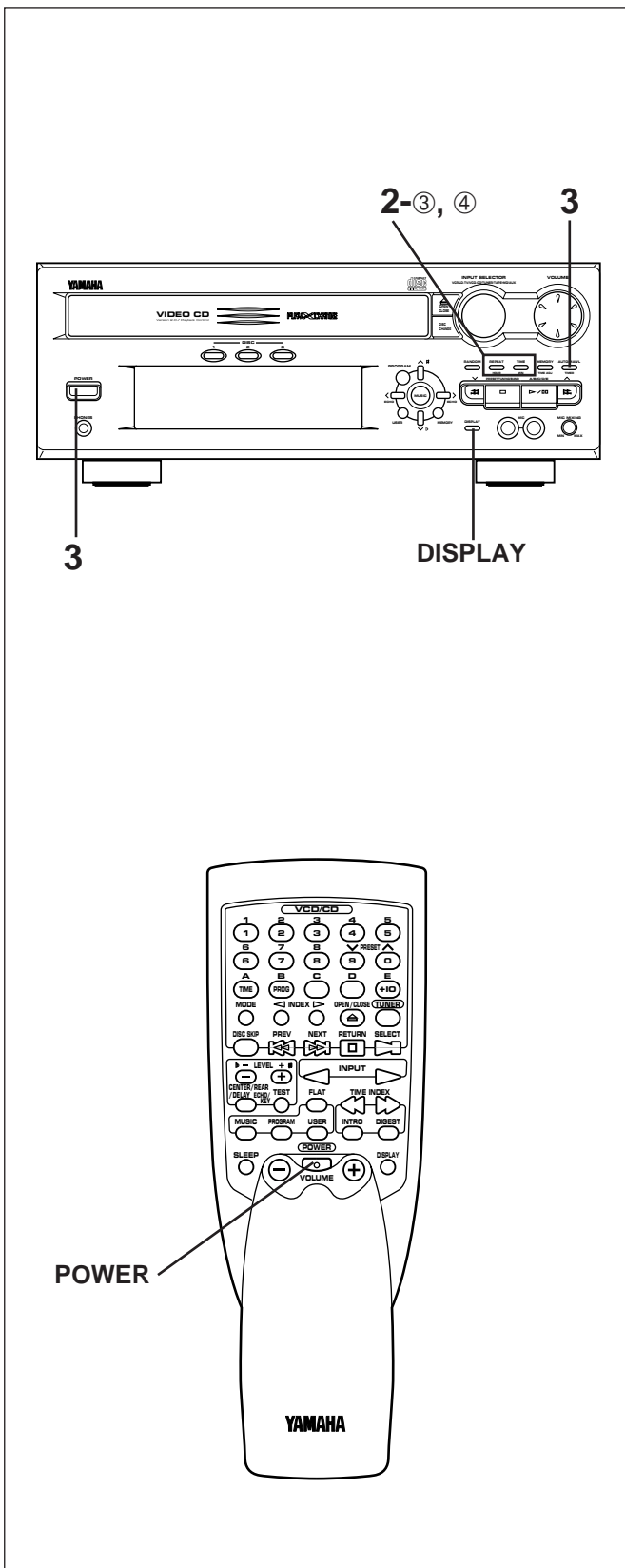

③ **ON TIME/time setting mode**
 ["ON TIME" appears on the display, and soon it is changed to a time setting mode.]
 Set to the time when you want to begin the timer play by using the HOUR button and the MIN button.

④ **OFF TIME/time setting mode**
 ["OFF TIME" appears on the display, and soon it is changed to a time setting mode.]
 If necessary, set to the time when you want to finish the timer play (to turn this unit into the standby mode) by using the HOUR button and the MIN button. Even if you do not set the time, it has already been set so that the timer play finishes after 1 hour.

Note

The TIMER button functions also in the time (ON TIME or OFF TIME) setting mode. (However, it also turns this unit into the standby mode.)

3 If you will not use this unit until the timer play begins, turn this unit into the standby mode by pressing the POWER switch or the TIMER button.

Note

If a timer play setting is made and this unit is not turned into the standby mode, the source set for the timer play will begin playing when the time comes in place of the source played at that time.

To cancel the timer play setting

After the timer play is finished, press the DISPLAY button to call the current time. While the current time is displayed, press the TIMER button so that "TIMER" goes out from the display.

If it is not canceled, this unit will be turned on at the same time every day, so it can be used as an alarm. However, if you are planning to go out at that time, cancel the timer play setting.

* Unless the AC supply lead is unplugged or there is a power failure for more than 5 minutes, the time set on the timer will be retained until it is reset.

How to make time setting in the ON TIME or OFF TIME mode

For the hour:

Press the HOUR button to change the hour to a higher value. Press and hold to change continuously.

For the minute:

Use the MIN button and operate it in the same way as you did to change the hour.

HOW TO USE THE BUILT-IN TIMER

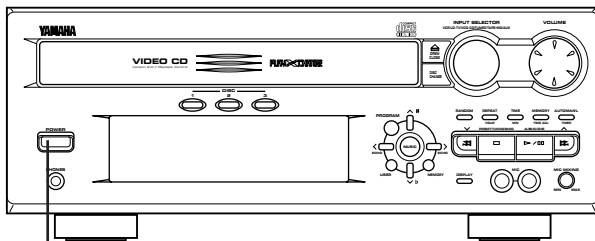

POWER

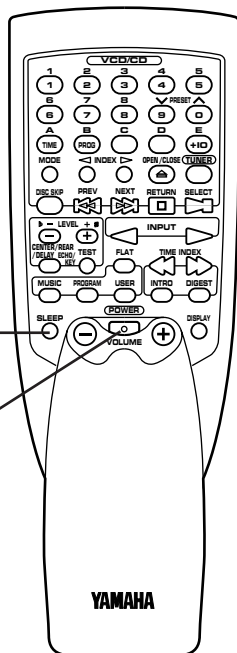

SLEEP

POWER

Sleep timer operation

This unit can be turned into the standby mode automatically.

- 1 Play the desired sound source.
- 2 Press the SLEEP button. "SLEEP" appears on the display, and soon it is replaced by "2h00m".
- 3 Press the SLEEP button repeatedly until the desired sleep time appears on the display. The display will change as described below. [Time is displayed by the hour (h) and the minute (m).]

2h00m → 1h30m → 1h00m → 0h30m

↑
OFF SLEEP ←
(Sleep timer is off.)

- * The original display mode will resume about 4 seconds after the selection is made.
- * The SLEEP indicator will light up to indicate that the sleep timer is on.

- 4 The unit will be turned into the standby mode automatically when the selected sleep time passes.

To confirm the sleep time setting

Press the SLEEP button once. "SLEEP" appears on the display, and soon it is replaced by the remaining time of the selected sleep time.

To change the sleep time

While the SLEEP indicator is illuminated, press the SLEEP button repeatedly until the desired time appears.

To stop the sleep timer operation

Press the POWER switch, or press the SLEEP button repeatedly until "OFF SLEEP" appears on the display. (The SLEEP indicator will go out.)

Using the timer and the sleep timer at the same time

- 1 Prepare timer play. (See page 38 and 39.)
 - * Do not turn this unit into the standby mode after the timer setting is finished.
- 2 Press the SLEEP button and set the sleep time.

When the sleep timer operation finishes, the timer begins functioning to turn the source on at the preset time.

Note

Do not make the timer time setting so that the timer will start during sleep timer operation. (Since sleep timer operation has priority, the timer will not operate.)

TROUBLESHOOTING

If your unit fails to operate normally, check the following points to determine whether the fault can be corrected by the simple measures suggested. If it cannot, or if the fault is not listed in the SYMPTOM column, disconnect the power cord and contact your authorized YAMAHA dealer or service center for help.

	SYMPTOM	CAUSE	REMEDY
THE SYSTEM	No power even if the POWER switch is pressed.	AC supply lead is not plugged in.	Plug into the AC supply lead.
	It happens that this unit does not work normally.	There is an influence of strong external noise (lightning, excessive static electricity, etc.) or a misoperation on this unit while using this unit.	Turn this unit in the standby mode and disconnect the AC power cord from the AC outlet. After about 30 seconds have passed, connect the power and operate this unit again.
	No sound from one speaker	Loose speaker connections.	Connect properly.
	No sound from speakers.	Internal protection circuit is functioning.	Unplug the AC supply lead from the wall AC outlet, and then plug in again.
	No sound from the rear speakers.	One rear speaker connection is loose or bad.	Connect it properly.
		The sound output level to the rear speakers is set to minimum.	Raise the sound output level to the rear speakers.
		No sound field program is selected.	Select the appropriate program.
	No sound from the center speaker.	The sound output level to the center speaker is set to minimum.	Raise the sound output level to the center speaker.
		The center channel mode is in PHANTOM mode.	Select NORMAL mode.
		Incorrect sound field program selection. No sound field program is selected.	Select the appropriate program.
	No sound (or no picture) from an external unit connected with this unit.	Incorrect cord connections.	Connect the cords properly. If the problem persists, the cords may be defective.
		Input source selection is not proper.	Make a proper input source selection.
	Can't set timer.	Current time is not set.	Set current time.
	This unit will not operate properly.	The internal microcomputer has been frozen by an external electric shock (lightning, excessive static electricity, etc.) or power supply with low voltage.	Unplug the AC supply lead from the wall AC outlet, and then plug in again after about one minute.
	Excessive static in FM broadcasts.	Interference from starting motor of nearby car.	Position the FM antenna as high and as far away from nearby roads as possible. Connect using a coaxial cable.
		Interference from thermostat of nearby electrical appliance.	
	Noise increases during stereo broadcasts.	Antenna input is too weak due to obstructions or excessive distance from broadcasting station.	Check antenna connections.
			Install a multi-element type FM antenna if possible.
	Stereo broadcasts are noisy and STEREO indicator blinks on and off.	Insufficient antenna input.	Install an antenna appropriate for the electric field strength of your area.
	Cannot select preset stations.	Preset memory has been erased.	Reprogram memory presets.
Buzzing or static during AM broadcasts.	Interference from source such as lightning, fluorescent lights, electric motors or thermostat of nearby electrical appliance.	Problem is difficult to eliminate but can be lessened by grounding AM loop antenna.	
	TV or microprocessor is being used nearby.	Move away from TV or microprocessor.	
AM broadcast sensitivity is poor.	Radio signal is weak or antenna is not properly connected.	Properly connect AM loop antenna.	
		Change orientation of AM loop antenna.	
		Install an external AM antenna.	
VIDEO CD PLAYER	A disc cannot be played back normally, or there is a noise during playback.	A nonstandardized disc is played back.	Play back another disc.
	Playback will not begin even if disc is loaded.	Disc is upside down.	Load disc label side up.
		Disc is dirty.	Clean disc.
	No sound (or no picture).	Setting of the INPUT SELECTOR.	Select the CD player by turning the INPUT SELECTOR.
	Sound stops suddenly (always at same spot).	Disc is dirty.	Clean disc.
Volume is set too high.		Lower volume.	
A picture is disturbed or unstable.	Setting of the TV MODE switch on the rear panel is improper.	Set the TV MODE switch to another proper position.	
REMOTE CONTROL	Remote control doesn't work.	Batteries are dead.	Replace batteries.
		Remote control is too far away or is being used at incorrect angle.	Use within 6 m and 60° radius.
		Direct sunlight or lighting (of an inverter type of fluorescent lamp etc.) is striking the remote control sensor of the main unit.	Change position of the main unit.
	TV functions strangely when the remote control is used.	Remote control is being used near TV set with a remote control sensor.	Relocate this unit away from the TV or cover TV's remote control sensor.

SPECIFICATIONS

As a part of policy of continuous improvement, YAMAHA reserves the right to make design and specification changes for product improvement without prior notice. The performance specification figures indicated are nominal values of production units.

■ Amplifier section

Minimum RMS Output Power per Channel

Front L, R	
6 ohms, 1 kHz, 10% THD	75W+75W
6 ohms, 1 kHz, 1% THD	65W+65W
Center	
8 ohms, 1 kHz, 10% THD	30W
8 ohms, 1 kHz, 1% THD	20W
Rear	
8 ohms, 1 kHz, 10% THD	30W
8 ohms, 1 kHz, 1% THD	20W

Input Sensitivity/Impedance

AUX	170 mV/47 k-ohms
-----------	------------------

Mic Input Sensitivity/Impedance

MIC	0.5 mV/4.7 k-ohms
-----------	-------------------

Headphone Output Impedance..... 68 ohms

Total Harmonic Distortion (1 kHz)

AUX (32.5W/6 ohms)	0.08%
--------------------------	-------

Signal-to-Noise Ratio (IHF-A Network)

AUX	75 dB
-----------	-------

Graphic Equalizer Characteristics

(100 Hz, 350 Hz, 1 kHz, 3.5 kHz, 10 kHz)	±10 dB
------------------------------------------------	--------

■ Video section

Video Signal Level	1 Vp-p/75 ohms
Maximum Input Level	1.5 Vp-p or more
Signal-to-Noise Ratio	50 dB or more
Monitor Out Frequency Response	5 Hz to 10 MHz, -3 dB

■ Tuner section

Tuning Range

FM	87.5 to 108.0 MHz
----------	-------------------

AM

[Singapore model]	531 to 1,611 kHz
-------------------------	------------------

[China and General models]	530 to 1,710 kHz
----------------------------------	------------------

Usable Sensitivity

FM (75 ohms)

(30 dB S/N Quieting, 1 kHz, 100% mod.)

.....	1.5 μ V (14.8 dBf)
-------	------------------------

AM	280 μ V/m
----------	---------------

■ Video CD player section

Type 3 DISC Carousel Auto-changer

Signal Readout

..... Non-contact, 3-beam semi-conductor laser pick-up

D/A Converter 1-bit DAC

Filter 8-time oversampling digital filter

Wow and Flutter Below measurable limits

■ General

Power Supply

[Singapore model]	AC 230V, 50 Hz
-------------------------	----------------

[China and General models]

.....	AC 110/120/220/240V, 60/50 Hz
-------	-------------------------------

Power consumption 180W

AC Outlet

UNSWITCHED OUTLET 100W max.

Dimensions (W x H x D) 435 x 171 x 383 mm

Weight 10.5 kg

YAMAHA ELECTRONICS CORPORATION, USA 6660 ORANGETHORPE AVE., BUENA PARK, CALIF. 90620, U.S.A.
YAMAHA CANADA MUSIC LTD. 135 MILNER AVE., SCARBOROUGH, ONTARIO M1S 3R1, CANADA
YAMAHA ELECTRONIK EUROPA G.m.b.H. SIEMENSSTR. 22-34, 25462 RELINGEN BEI HAMBURG, F.R. OF GERMANY
YAMAHA ELECTRONIQUE FRANCE S.A. RUE AMBROISE CROIZAT BP70 CROISSY-BEAUBOURG 77312 MARNE-LA-VALLEE CEDEX02, FRANCE
YAMAHA ELECTRONICS (UK) LTD. YAMAHA HOUSE, 200 RICKMANSWORTH ROAD WATFORD, HERTS WD1 7JS, ENGLAND
YAMAHA SCANDINAVIA A.B. J A WETTERGRENS GATA 1, BOX 30053, 400 43 VÄSTRA FRÖLUNDA, SWEDEN
YAMAHA MUSIC AUSTRALIA PTY, LTD. 17-33 MARKET ST., SOUTH MELBOURNE, 3205 VIC., AUSTRALIA

YAMAHA
YAMAHA CORPORATION
VZ35830