



POCKET RECORDER
POCKETRAK 2G
Reference Manual

Table of Contents

Starting Up	4	Playback	18
Controls	4	Stopping playback.....	18
LCD screen	4	Changing playback speed.....	18
Adjusting the direction of the built-in microphones (Tilt up)	5	Fast forward playback.....	18
Inserting a battery	5	Fast reverse playback	19
Battery indicator	5	Skipping to the next or previous file	19
Basic Operations	6	Index search	19
Selecting a menu item	6	Setting the Clear Voice function.....	19
Canceling the operation or return to the previous display	6	Playing back files recorded from external devices	19
Using the headphones	6	Playing back music files.....	20
Using an external stereo microphone	6	Display in the M folder during playback	20
Turning the power on or off.....	6	Creating and playing back music files from sub- folders	21
Auto power off function	6	Repeat/Random playback.....	22
Hold function	7	Five-second replay	22
Adjusting the volume.....	7	Deleting	23
Date and time settings.....	7	Deleting the selected file	23
Recording.....	9	Deleting all files in the selected folder	23
Recording time.....	9	Deleting index marks	24
Selecting the recording mode	9	Formatting (Deleting all files in all folders) ...	24
Starting recording.....	10	Using timers	25
Stopping recording.....	11	Setting the alarm timer	25
Pausing recording	11	Setting the recording timer	26
Inserting index marks.....	11	Security function	28
Setting the Auto Level Control (MIC ALC).....	12	About the public area and the security area.....	28
About Auto Level Control (MIC ALC).....	12	About playback in the security area (S folder)	28
Scenarios for the MIC ALC function.....	12	Turning the security lock on and off	28
Selecting the microphone sensitivity	13	Turning the security lock on	28
With MIC ALC "ON":.....	13	Turning the security lock off	29
With MIC ALC "OFF":	13	Playing back a file in the locked S folder.....	29
VAS (Voice Activated System) recording	15	Security setting and icons	30
Recording from external audio devices.....	16	Returning to the public area folders.....	30
Auto Divide function	17	Setting the menu options	31
		General procedure for setting menu options	31
		VOICE menu options.....	32
		MUSIC menu options	32
		COMMON menu options	33
		Switching among different display indicators.....	34

Connecting to a Computer	35	Using the unit as a music player	43
Computer system requirements	35	Recording music files	43
Connecting the unit to your computer	35	Ripping CDs (transferring music files to your computer).....	43
About the USB connection	35	Copying data using Explorer	46
Precautions when using the USB terminal	36	(1) Copying files to the unit.....	46
Selecting the Windows action	37	(2) Copying files to your computer.....	46
Disconnecting the unit from your computer... ..	38	Transferring data using Windows Media Player.....	47
Recharging the eneloop	38	Creating a Playlist	48
Before recharging the eneloop	38	Selecting the Playlist:	48
Recharging the eneloop	38	Appendix	49
Canceling the recharge operation	39	Troubleshooting.....	49
Viewing removable disks via Explorer	40	FAQ	52
Starting Explorer	40	Specifications	53
About the folder in Removable Disk.....	41		
[VOICE] and [VOICE_S] folders.....	41		
[MUSIC] folder	41		
[DATA] and [DATA_S] folders	42		
[Manual] folder	42		
[ALARM] folder.....	42		
[LINE] folder.....	42		
Security setting and removable disk display ..	42		

* The illustrations and LCD screens shown in this manual are for instructional purposes only, and may appear somewhat different from those on your instrument.

* Windows® and Windows Media® player are trademarks or registered trademarks of Microsoft® Corporation in the United States and other countries.

* The company names and product names in this manual are the trademarks or registered trademarks of their respective owners.

Starting Up

Controls

- 1 Built-in microphones (L, R)
- 2 REC/PEAK LED
- 3 External stereo microphone/Line socket ()
- 4 Skip/Search button (▶▶)
- 5 Play/Select button (▶)
- 6 Skip/Search button (◀◀)
- 7 Volume buttons (VOL +, -)
- 8 Folder/Index button (FOLDER/INDEX)
- 9 LCD screen
- 10 Delete button (DEL)
- 11 Pause/Record button (PAUSE/REC)
- 12 Menu/Stop button (MENU/STOP)
- 13 Speaker
- 14 Headphones socket ()
- 15 Power/Hold switch (POWER/HOLD)
- 16 Playback speed control switch (PLAY SPEED)
- 17 Battery compartment lid
- 18 USB terminal slide switch
- 19 USB terminal cover (may be rotated)
- 20 USB terminal

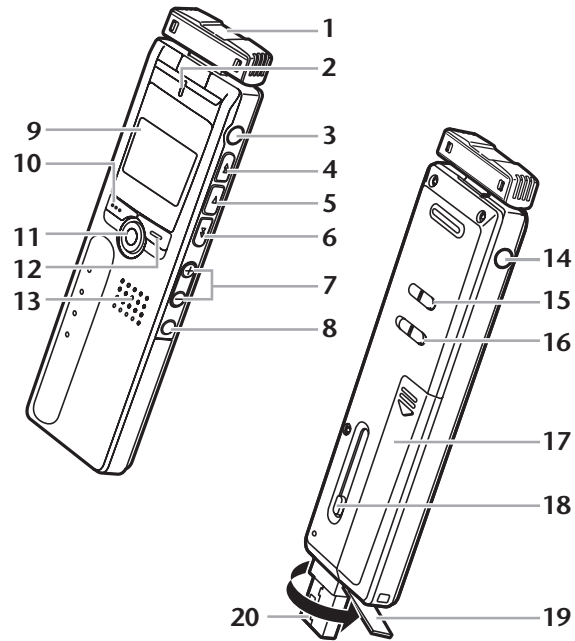

LCD screen

- 1 Repeat/Random/5-second replay (ONE, ALL, RND, 5SEC)
- 2 Battery indicator
- 3 Battery setting (e: eneloop, A: Alkaline)
- 4 Recording mode (XHQ, HQ, SP, LP, PCM)
- 5 VAS (Voice activated system)
- 6 Microphone sensitivity
- 7 External recording mode (MIC, LINE)
- 8 Playback Lock/Release
- 9 Timer/Alarm
- 10 File number
- 11 Total file number
- 12 Information display (Time/Message/Mode etc.)
- 13 Security setting On/Off (S folder only)
- 14 Folder (A, B, C, D, S, L, M)

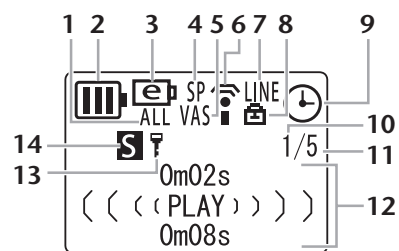

Adjusting the direction of the built-in microphones (Tilt up)

You can adjust the direction of the built-in microphones. For example, if you place the unit on a table to record, you can tilt the mic up to avoid noise from the table top. Adjust the direction of the mic to suit the recording circumstances.

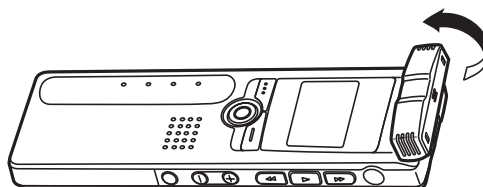

Note:

- Do not adjust the microphone angle during recording. Otherwise, undesirable handling noise will be recorded.

Inserting a battery

 Turn the power off before you replace the battery.

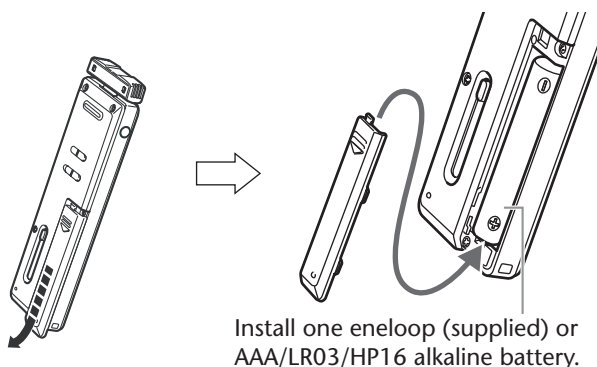



Install one eneloop (supplied) or AAA/LR03/HP16 alkaline battery.

Note:

- If you use an alkaline battery, press and hold down the MENU/STOP button for at least two seconds to access the COMMON menu, then select "ALKALINE" for the BATTERY SETTING (page 33).

Battery indicator

Check the battery indicator on the LCD screen to determine the remaining battery power.

- : Good condition
- : Weak battery
- : Exhausted battery: Recharge the "eneloop" (page 38) or replace the battery with a new alkaline battery. If you keep using the recorder without recharging the "eneloop" or replacing the battery, the recorder will display the message "LOW BATTERY PLEASE CHARGE A BATTERY" or "LOW BATTERY." The LCD screen will then go dark.

Basic Operations

Selecting a menu item

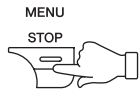

Press and hold down the MENU/STOP button for at least two seconds.

Press the ►► or ◀◀ button: Moves the cursor highlight up/down.

Press the ► button: Selects the menu item.

Canceling the operation or return to the previous display

Press the MENU/STOP button: Returns to the previous display.

Using the headphones

Connect the headphones to the  socket. The speaker will be disconnected automatically.

Using an external stereo microphone

Connect an external stereo microphone (not supplied) to the  socket (page 16). The built-in microphones are automatically disconnected.

Note:

- If you use an external stereo microphone, press and hold down the MENU/STOP button for at least two seconds to access the VOICE menu, then select "MIC" for the REC SELECT.

Turning the power on or off

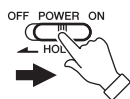

Set the POWER/HOLD switch to the right.

"HELLO!" appears briefly on the display and the power turns on, and then the last selected file number appears (Resume function).

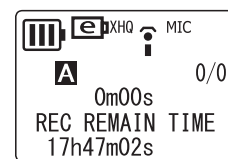

Set the POWER/HOLD switch to the left. "SEE YOU!" appears on the display and the power turns off.

Auto power off function

- If you leave the unit turned on for 15 minutes without using it, the unit will automatically turn off.
- If you leave the unit turned on with a recording paused for more than 15 minutes, the unit will turn off the power after it creates the recorded file.

Hold function

The Hold function can help you to avoid stopping operation (playback or recording) by accidentally pressing a button.

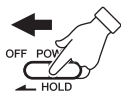

Set the **POWER/HOLD** switch to the left while the unit is operating.
The Hold function is engaged.

- If an operation button is pressed while the Hold function is engaged, "HOLD ON" will appear on the display and nothing else will happen.

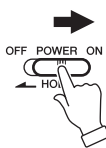
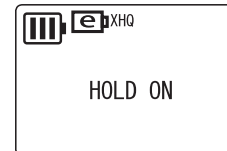

Set the **POWER/HOLD** switch to the right.
"HOLD OFF" appears on the display and the Hold function is disengaged.

- If operation (playback or recording) is finished while the Hold function is engaged, the unit automatically shuts down.

Adjusting the volume

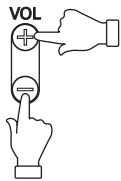

Press the **VOL +** or **-** button.
The volume level appears on the display (VOLUME 0 to VOLUME 20).

Date and time settings

1. While the recorder is stopped, press the **MENU/STOP** button for at least two seconds.
2. Press the **▶▶** or **◀◀** button to select "COMMON", then press the **▶** button.
3. Press the **▶▶** or **◀◀** button to select "DATE & TIME", then press the **▶** button.
4. Press the **▶▶** or **◀◀** button to select the year, then press the **▶** button.
5. In the same way, set the month, day, 24H or AM/PM (12H) display, hour and minute.

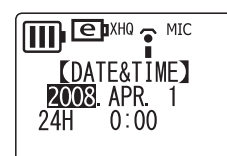

6. Press the MENU/STOP button twice to exit from the menu setting mode.
The date and time settings are complete.

Note:

- *Calendar settings may be lost if the battery is removed for longer than 10 minutes. If so, reset the calendar settings.*
 - *The time display might become slightly inaccurate if the unit is used for an extended period of time. If this happens, reset the calendar settings.*
-

Recording

Recording time

The recording time differs depending on the recording mode, as shown below.

Recording mode	Recording time (approx.)	
	PUBLIC AREA (A, B, C and D folder)	SECURITY AREA (S folder)
PCM: Pulse Code Modulation (stereo)	2hr. 50 min.	10 min.
XHQ: Extra high-quality (stereo)	25 hr. 20 min.	2 hr. 15 min.
HQ: High-quality (stereo)	63 hr. 20 min.	4 hr. 35 min.
SP: Standard (stereo)	126 hr.	9 hr. 15 min.
LP: Long (monaural)	253 hr.	18 hr. 30 min.

Selecting the recording mode

 Make sure that the battery has sufficient power to record.

1. While the recorder is stopped, press the MENU/STOP button for at least two seconds.
2. Press the ►► or ◀◀ button to select "VOICE", then press the ► button.
3. Press the ►► or ◀◀ button to select "REC MODE", then press the ► button.

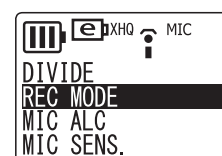

4. Press the ►► or ◀◀ button to select a recording mode, then press the ► button. The display indicates "REC MODE".

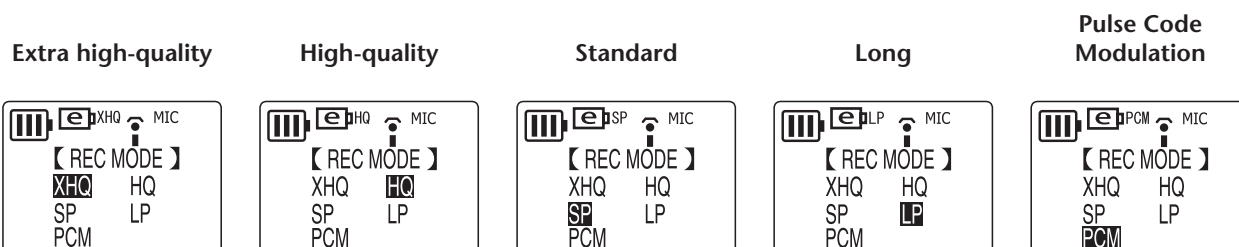

5. Press the MENU/STOP button twice to exit from the menu setting mode. The recording mode setting is complete.

Note:

- If you record and delete files quite frequently, there is a chance that the unit may eventually skip while recording in PCM mode. To avoid such skipping, save desired recordings to your computer, then reformat the recorder's internal memory.

Starting recording

 **Do not remove the battery during recording.**

You can adjust the direction of the built-in microphones to suit your recording situation ([page 5](#)).

1. Press the FOLDER/INDEX button to select a folder (A, B, C, D or S).

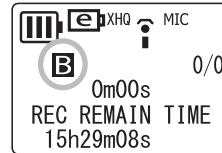

Hint:

The A, B, C, D and S folders store audio files (such as a conversation, for example) recorded via the recorder's microphones. The L folder stores music recorded from a connected external device, such as a CD player. The M folder stores music files transferred from a computer.

For detailed explanation of the folders, refer to [page 41](#).

Note:

- Press and hold down the FOLDER/INDEX button for at least two seconds to select the S folder.
- Do not select the L or M folder. The L and M folders are not VOICE folders. If you select one of them, built-in microphone recordings will be recorded automatically to the A folder. However, if the A folder is full, no additional built-in microphone recordings are possible (until you delete some recordings).
- The unit can record up to 99 files in any one folder (A, B, C, D or S). "FILE FULL" appears if you attempt to record a 100th file in any folder.

2. Press the PAUSE/REC button.



The recording LED lights up and recording starts.

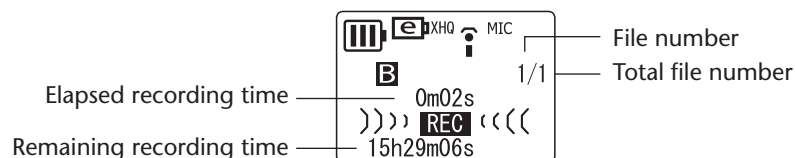

Note:

- When MIC ALC is set to OFF, the recorder enters the recording standby mode. Press the PAUSE/REC button again to start recording.
- With some files, the elapsed recording time displayed on the LCD may differ from the actual elapsed time.

Hint:

The recording LED can be turned off ([page 33](#)).

You can monitor audio that is currently being recorded by listening through headphones (supplied) that you connect to the unit. Use the VOL + or – button to adjust the monitoring level.

Stopping recording

Press the MENU/STOP button.

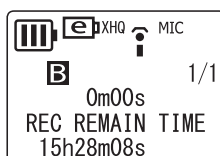
**Pausing recording**

Press the PAUSE/REC button.

Press it again to resume recording.

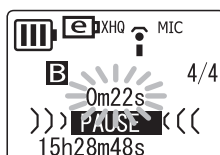
**Inserting index marks**

You can insert index marks only in the files in the VOICE folder.

To insert an index mark, press the FOLDER/INDEX button during recording.

"INDEX SETTING 1/32" appears briefly and recording continues.

Note:

- You can insert up to 32 index marks in each file. If you try to enter additional index marks, "INDEX FULL" appears briefly on the display. You can delete all index marks as a group, but you cannot delete individual index marks.

Hint:

You can insert index marks also during playback. To insert an index mark, press the FOLDER/INDEX button during playback. "INDEX SETTING 1/32" appears briefly and playback continues.

Setting the Auto Level Control (MIC ALC)

About Auto Level Control (MIC ALC)

Auto Level Control is a function that automatically maintains the recording volume close to a specified level during recording under various recording environments. The function maintains a consistent recording level by recording loud sounds at lower levels and quiet sounds at higher levels. As a result, files recorded with this function will play at a comfortable level, with no clipping noise or distortion.

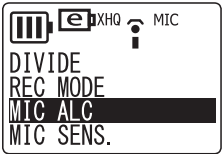
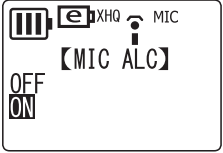

Scenarios for the MIC ALC function

MIC ALC	Scenarios	Features
ON	Recording meetings, conversations, interviews	You can make recordings that are less dynamic but maintain consistent sound levels for various voices or sources.
OFF	Recording music practices; recording sound sources so that playback retains relative source levels as heard in the recording environment	You can adjust and optimize the recording level to make recordings that accurately represent to the original sound.

1. While the recorder is stopped, press the MENU/STOP button for at least two (2) seconds.
2. Press the ►► or ◀◀ button to select "VOICE", then press the ► button.
3. Press the ►► or ◀◀ button to select "MIC ALC", then press the ► button.
 
4. Press the ►► or ◀◀ button to select "ON" or "OFF", then press the ► button.
 
5. Press the MENU/STOP button twice to exit from the menu setting mode. The MIC ALC setting is complete.

Note:

- If you change the MIC ALC setting, the icon displayed in the LCD screen changes as below.

With MIC ALC on:	
With MIC ALC off:	

Selecting the microphone sensitivity

With MIC ALC "ON":

1. While the recorder is stopped, press the MENU/STOP button for at least two (2) seconds.
2. Press the ►► or ◀◀ button to select "VOICE", then press the ► button.
3. Press the ►► or ◀◀ button to select "MIC SENS.", then press the ► button.

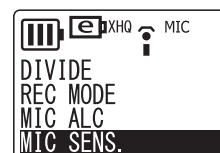

4. Press the ►► or ◀◀ button to select "HIGH", "MIDDLE" or "LOW", then press the ► button.
 - HIGH: High sensitivity
 - MIDDLE: Middle sensitivity
 - LOW: Low sensitivity

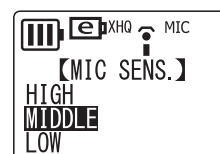

5. Press the MENU/STOP button twice to exit from the menu setting mode. The setting of the microphone sensitivity is complete.
6. Press the PAUSE/REC button to start recording.

With MIC ALC "OFF":

1. Press the PAUSE/REC button to enter the recording standby mode. Adjust the angle of the built-in microphones toward the sound to be recorded.
2. Press the ►► or ◀◀ button to adjust the microphone sensitivity while checking the level meter. The microphone sensitivity can be adjusted to 31 levels (Level 0 to level 30).
3. Press the PAUSE/REC button to start recording.

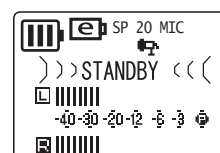

Note:

- The LCD screen changes while you adjust the microphone sensitivity as shown below.

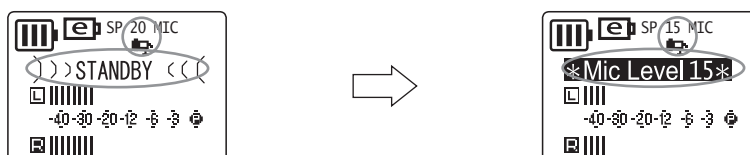

- The recorder will remember the specified microphone sensitivity for the next recording session.
- Adjusting the microphone sensitivity during recording may cause unwanted noise to be recorded. Adjust the sensitivity only when the recorder is in recording standby mode.

Adjusting the microphone sensitivity

The level meter moves to left or right as the volume level of the sound source changes.

If the sensitivity level is low:

If the level meter moves only very slightly, raise the microphone sensitivity by pressing the ►► button so that the level meter will move moderately to the right.

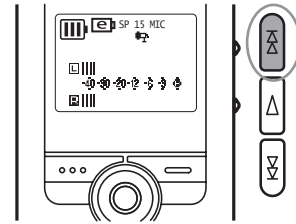

If the sensitivity level is high:

If the level meter frequently moves all the way to the right and the REC/PEAK LED lights up, recorded sounds may be distorted. Press the ◀◀ button to lower the microphone sensitivity.

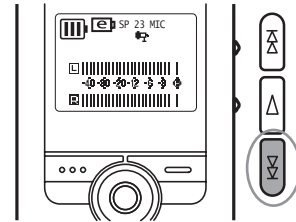

If the sensitivity level is optimum:

The microphone sensitivity is optimum when the meter indicates a “-6” level consistently, without deflecting all the way to the right at loud sounds.

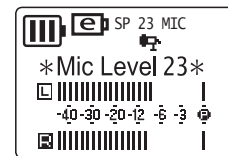

Note:

- You cannot change the microphone sensitivity setting while the recorder is stopped.
- At a level of zero (0), the recording will be silent.
- Turn on the MIC ALC function when you record any sound source other than music.

VAS (Voice Activated System) recording

When the VAS recording function is turned on, and if the unit is in recording pause mode, the unit will automatically start to record as soon as it detects audio at a level above a certain threshold.

The unit will pause recording when the detected audio level falls below the threshold.

Note:

- VAS recording is available only when MIC ALC is set to ON.

1. While the recorder is stopped, press the MENU/STOP button for at least two (2) seconds.
2. Press the ►► or ◀◀ button to select "VOICE", then press the ► button.
3. Press the ►► or ◀◀ button to select "VAS", then press the ► button.



4. Press the ►► or ◀◀ button to select "ON", then press the ► button.

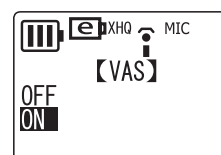

5. Press the MENU/STOP button twice to exit from the menu setting mode.
6. Press the PAUSE/REC button.
Recording begins automatically when the unit detects audio.

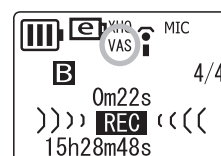

Note:

- You can set the voice sensing level by pressing the ►► or ◀◀ button during recording. The recorder displays the sensing level ("VAS" 1: Low – "VAS" 5: High).
- Set this function to OFF if you are recording important material. Otherwise, if the source audio level is too low, the unit will not detect the audio and will not start recording.





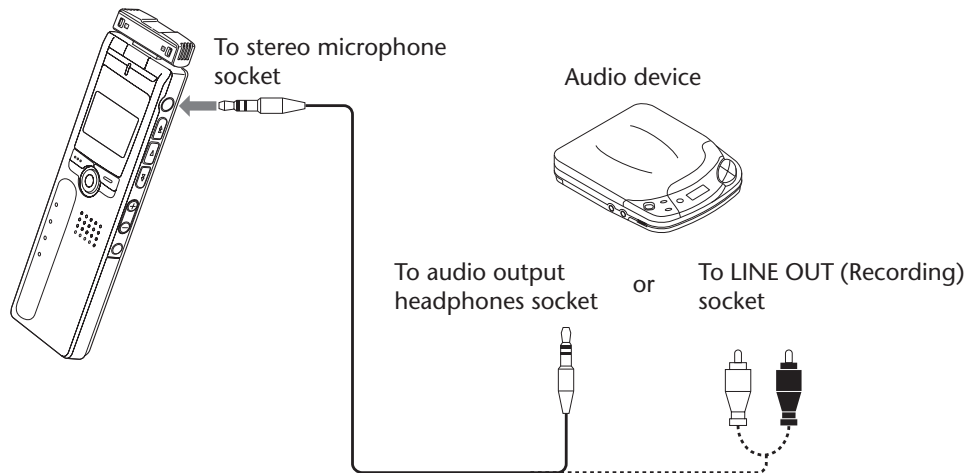



Recording from external audio devices

1. Use an audio cable to connect the stereo microphone socket ( socket) to the headphones socket on the external audio device.



Note:

- For audio cable, use a 3.5mm stereo mini plug without resistance.

2. While the recorder is stopped, press the MENU/STOP button for at least 2 seconds.
3. Press the  or  button to select "VOICE", then press the  button.
4. Press the  or  button to select "REC SELECT", then press the  button.
5. Press the  or  button to select "LINE", then press the  button.



Note:

- If you record audio with an external stereo microphone, select "MIC" (page 6). For external microphones, Yamaha recommends that you use an electret condenser microphone with the capabilities of plug-in power operation, 2k Ω impedance, performance guaranteed with a 1.3V power supply, and a 3.5mm stereo mini plug.

6. Press the MENU/STOP button twice to quit the menu setting mode.
7. Press the FOLDER/INDEX button to select the L (Line) folder.
Even if one of the other folders is selected, audio data will be recorded in the L folder.
8. Start playback on the external device, then press the PAUSE/REC button on the recorder to start recording.

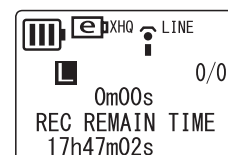

Note:

- Audio is automatically recorded in XHQ mode.
- The unit can record up to 199 files in the L (Line) folder. If you attempt to record the 200th file, the recorder will indicate "FILE FULL".
- When you record to the L folder, MIC ALC is automatically set to OFF.

Auto Divide function

When the Auto Divide function is turned on, the unit automatically detects the silence between songs and records each song as an individual file. This function is useful when you are recording songs from a CD player.

1. While the recorder is stopped, press the MENU/STOP button for at least 2 seconds.
2. Press the ►► or ◀◀ button to select "VOICE", then press the ► button.
3. Press the ►► or ◀◀ button to select "AUTO DIVIDE", then press the ► button.
4. Press the ►► or ◀◀ button to select "ON", then press the ► button.



5. Press the MENU/STOP button twice to quit the menu setting mode.

Note:

- The function does not work if the recorder does not recognize a silent pause of at least two seconds between songs, especially when it is recording audio from a cassette tape, radio, and so on.
- If the unit detects a silent pause for 15 seconds or more, recording stops automatically.

Playback

1. Press the FOLDER/INDEX button to select a folder (A, B, C, D, L or M).
2. Press the ►► or ◀◀ button to select a file.

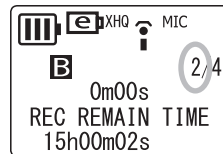

3. Press the ► button.
Playback begins.

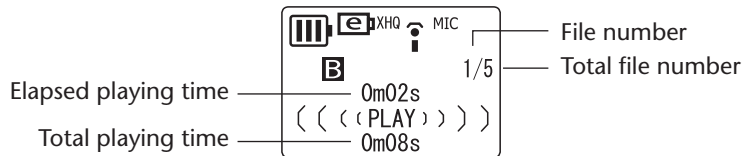

Stopping playback

Press the MENU/STOP button.
Press the ► button to resume playback.

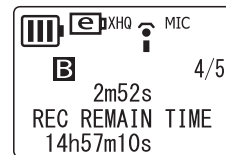

Note:

- A few seconds may be required to start playback of a file or an extremely large number of files.
- Depending on the MP3/WMA file, the displayed playing time may vary from the actual playing time.
- You may be unable to play certain MP3/WMA files on this unit.

Changing playback speed



Use the Playback speed control switch to change the playback speed.

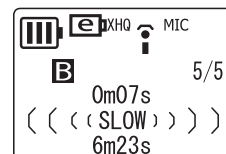

- SLOW (Slow speed playback)
- NORMAL (Normal speed playback)
- FAST (Fast speed playback)

Note:

- This function may not work with the files recorded in PCM mode.

Fast forward playback

Press and hold down the ►► button during playback to fast forward the file currently being played.
When the end of the file is reached, the unit starts fast forwarding the next file.

Fast reverse playback

Press and hold down the ◀◀ button during playback to fast reverse the file currently being played.

When the beginning of the file is reached, the unit starts fast reversing from the end of the previous file.

Release the ▶▶ or ◀◀ button to resume normal playback.

Skipping to the next or previous file

Press the ▶▶ or ◀◀ button while the unit is playing back or stopped.

Index search

If an index mark has been inserted in the file, press the ▶▶ or ◀◀ button during playback.

The unit will search for the next or previous index point. Playback will resume from that point.

Setting the Clear Voice function

The Clear Voice function makes audio playback less noisy.

If you hear unwanted static or noise during playback of a file in the VOICE folder, press the FOLDER/INDEX button for two (2) seconds or more. The unit briefly displays "CLEAR VOICE ON" on the LCD. The audio will be more clear and less noisy.

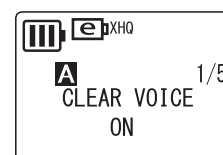

Press the FOLDER/INDEX button for at least two (2) seconds again to turn off the function.

Note:

- This function applies only to files in the VOICE folder.
- This function is especially effective on the playback of files recorded in PCM, XHQ and HQ mode.
- Depending on how the audio was recorded, the noise may not be reduced.

Playing back files recorded from external devices

1. Press the FOLDER/INDEX button to select the L (LINE) folder.
2. Press the ▶▶ or ◀◀ button to select a desired file, then press the ▶ button. Playback begins.

Note:

- You cannot insert Index marks into files stored in the L folder.

Playing back music files

 You must transfer music files from your computer to the M folder before playback.

1. Press the FOLDER/INDEX button to select the M (MUSIC) folder.
2. Press the **▶▶** or **◀◀** button to select a desired file, then press the **▶** button. An artist name, and the title or file name appear on the LCD, and playback begins.

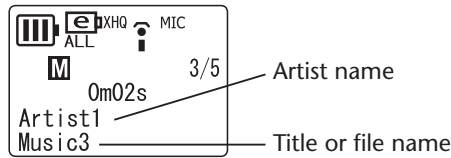

Display in the M folder during playback

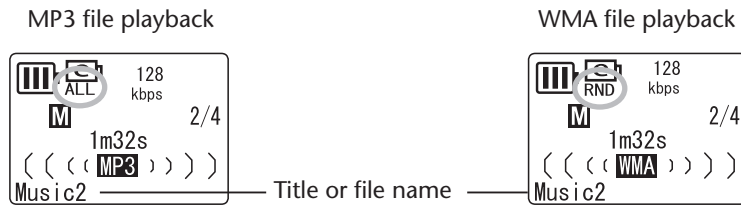

- “MP3” or “WMA” indicator and a bit rate (kbps) appear on the LCD.
- The Repeat or Random playback indicator (ONE, ALL or RND) will also appear if Repeat/Random playback has been programmed ([page 22](#)).

Note: _____
 · The artist name or title may not be displayed for some music files.

Creating and playing back music files from sub-folders

When transferring files to the unit, you can create multiple sub-folders in the MUSIC folder into which you can copy files. Folders are created directly inside the MUSIC folder (page 41). Follow the steps below to select and play back a file in one of the sub-folders.

1. Press the FOLDER/INDEX button to select the M (music) folder.
2. Press the ►► or ◀◀ button to select the desired folder. Then press the ► button.

Hint:

Press the FOLDER/INDEX button to move from the second to the first level of the MUSIC hierarchy (see "Folder hierarchy example" below).

3. Press the ► button again to start playback of the music files in the selected folder.

The unit displays "☐" on the LCD screen.

Note:

- While the unit is stopped, press the FOLDER/INDEX button to exit from M (music) folder.
- You can play files located at the first or second level of the MUSIC folder hierarchy.

Hint:

Folder hierarchy example:

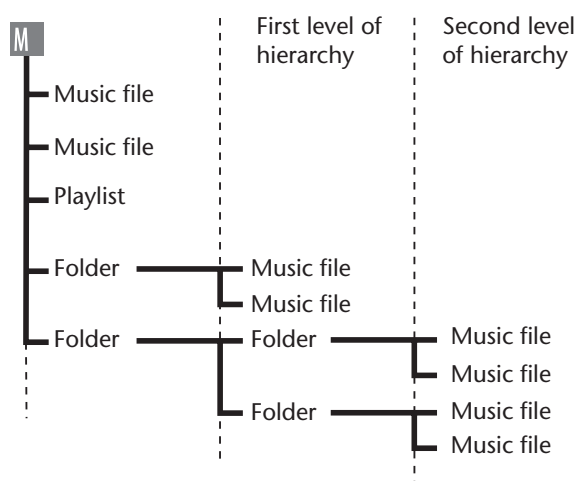

Repeat/Random playback

This function applies to files in the M (music) or L (line) folder.

1. While the unit is stopped, press the MENU/STOP button for at least two (2) seconds.
2. Press the ►► or ◀◀ button to select "MUSIC", then press the ► button.
3. Press the ►► or ◀◀ button to select "REPEAT", then press the ► button.
4. Press the ►► or ◀◀ button to select the desired mode (ONE, ALL or RANDOM), then press the ► button.



OFF:	No repeats
ONE:	Repeats only the current file.
ALL:	Repeats all files in the current folder.
RANDOM:	Repeats all files in the current folder in random sequence.

5. Press the MENU/STOP button twice to exit menu setting mode.
6. Press the ► button to start playback.

Five-second replay

This function enables you to rewind to a location five seconds before the current playback point and repeatedly replay this five-second segment. It is very useful if you wish to repeatedly playback short phrases.

1. During playback, press the ► button at the end of the section you want to replay.
The unit rewinds to five seconds prior to the current playback point and repeatedly replays the five-second segment.
2. Press the ► button again to cancel the playback.

Note: _____

- If you press the ► button before five seconds of playback elapses, the unit will return to the beginning of the file and repeatedly play the segment up to the point at which you pressed the ► button.

Deleting

 *The deleted file is not recoverable.*

Deleting the selected file

1. Press the FOLDER/INDEX button to select a folder.
2. Press the DEL button.



3. Press the **▶▶** or **◀◀** button to select "FILE", then press the **▶** button.
4. Press the **▶▶** or **◀◀** button to select the file to be deleted, then press the **▶** button.



5. Press the **▶▶** or **◀◀** button to select "YES", then press the **▶** button.
The selected file is deleted.

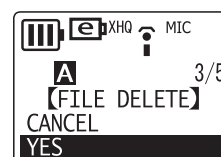

Note:

- After you delete a file, the subsequent files will be renumbered automatically. (For example, if you delete File 2 from a set of Files 1, 2, and 3, then File 3 will be renumbered as File 2.)
- Only MP3/WMA files that can be played on this unit can be deleted. You cannot delete files in any other formats.

Deleting all files in the selected folder

1. Press the DEL button.
2. Press the **▶▶** or **◀◀** button to select "FOLDER", then press the **▶** button.
3. Press the **▶▶** or **◀◀** button to select the folder to be deleted, then press the **▶** button.

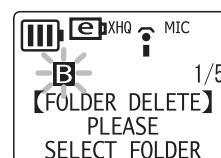

4. Press the **▶▶** or **◀◀** button to select "YES", then press the **▶** button.
All files in the selected folder are deleted.

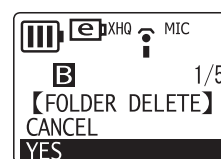

Note:

- Deleting a VOICE (A, B, C, D or S) folder is not permitted if the folder contains file(s) that were not recorded in the VOICE folder.
- You cannot delete any MP3/WMA files that are not stored in the playable folders.

Deleting index marks

1. Press the FOLDER/INDEX button to select a folder.
2. Press the DEL button.
3. Press the ►► or ◀◀ button to select "INDEX", then press the ► button.
4. Press the ►► or ◀◀ button to select a file containing the index marks to be deleted, then press the ► button.
5. Press the ►► or ◀◀ button to select "YES", then press the ► button.
All index marks in the selected file are deleted.

If you wish to abort the delete operation, press the MENU/STOP button once or twice.

Formatting (Deleting all files in all folders)



Back up to your computer all data on the unit that you wish to keep. Files deleted from the unit cannot be recovered.

If you select the format function from the menu, the memory will be initialized and all files will be deleted. Be careful not to use this function unless you are certain that you want to delete all data.

1. While the unit is stopped, press the MENU/STOP button for at least two (2) seconds.
2. Press the ►► or ◀◀ button to select "COMMON", then press the ► button.
3. Press the ►► or ◀◀ button to select "FORMAT", then press the ► button.
4. Press the ►► or ◀◀ button to select "PUBLIC AREA" or "SECURITY AREA", then press the ► button.
The unit displays "FORMATTING", then "COMPLETE". All files are deleted. The unit then displays "FORMAT".



PUBLIC AREA:	All data other than the data in the S folder is deleted.
SECURITY AREA:	All data in the S folder is deleted.

5. Press the MENU/STOP button twice to exit from the menu setting mode.

Note:

- If you format the security area, the security setting is canceled and the custom-set pass-code is reset to "0000" (factory default).

Using timers

Set the date and time before you set any timers (page 7).

Setting the alarm timer

A file (or an alarm sound) can be played at a designated time. Before you program the timer, place the file to be played in the ALARM folder (page 42). A beep will sound for 10 seconds if there are no files in the ALARM folder.

1. While the unit is stopped, press the MENU/STOP button for at least two (2) seconds.
2. Press the ►► or ◀◀ button to select "COMMON", then press the ► button.
3. Press the ►► or ◀◀ button to select "TIMER & ALARM", then press the ► button.
4. Press the ►► or ◀◀ button to select "ALARM", then press the ► button.

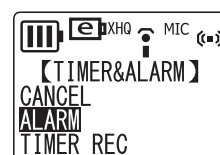

Note:

- If you want to cancel the alarm timer, select "CANCEL" instead, then press the ► button.

5. Press the ►► or ◀◀ button to specify the hour, then press the ► button.
The minute digits are highlighted.



6. Press the ►► or ◀◀ button to specify the minute, then press the ► button.
7. Press the ►► or ◀◀ button to select the alarm sound, then press the ► button.

BEEP:	Beep sound
MUSIC:	Plays the audio file in the ALARM folder.



8. Press the MENU/STOP button twice to exit from the menu setting mode.
At the programmed time, the alarm timer will be activated and a file or beep will be played through the speaker or headphones.

Setting the recording timer

 **Make sure that the battery power is sufficient before you set the recording timer.**

You can set the unit to make a recording of a specified duration that will start automatically at a designated time. The recorded file will be created in the designated folder.

1. While the unit is stopped, press the MENU/STOP button for at least two (2) seconds.
2. Press the **▶▶** or **◀◀** button to select "COMMON", then press the **▶** button.
3. Press the **▶▶** or **◀◀** button to select "TIMER & ALARM", then press the **▶** button.



4. Press the **▶▶** or **◀◀** button to select "TIMER REC", then press the **▶** button.
The unit displays the record start time. The hour digits are highlighted.

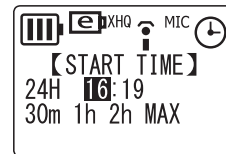

Note:

- If you want to cancel the recording timer, select "CANCEL" instead, then press the **▶** button.

5. Press the **▶▶** or **◀◀** button to specify the hour, then press the **▶** button.
The minute digits are highlighted.
6. Press the **▶▶** or **◀◀** button to specify the minute, then press the **▶** button.
7. Press the **▶▶** or **◀◀** button to select the desired recording duration (30m, 1h, 2h or MAX), then press the **▶** button.

Timer recording time (approx.):

30m:	30 min
1h:	60 min.
2h:	120 min.
MAX:	Recording will continue until you press the MENU/STOP button or until the available recording time is used up.

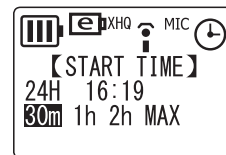

8. Press the **▶▶** or **◀◀** button to select the desired recording folder, then press the **▶** button.

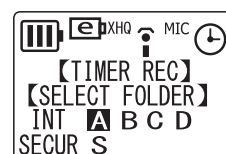

9. Press the MENU/STOP button twice to exit menu setting mode.

10. Turn the power off if required.

Recording will start at the designated time.

If timer recording does not start for one of the following reasons, a crossed timer indicator appears on the LCD as shown below.

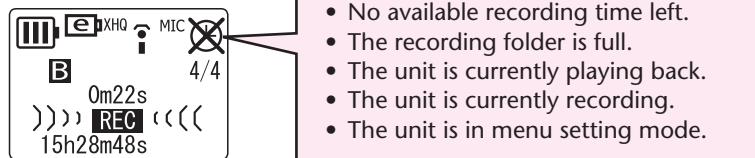

Note:

- You cannot set the alarm timer and the recording timer to the same time.
- Once the alarm timer or the recording timer is executed, the corresponding timer setting will be cleared.

Security function



Be sure to write down your passcode and keep it in a safe place. If you forget the passcode, you will be unable to play or access any files in the security folder. Yamaha will be unable to decrypt or reset the passcode for you.

Note:

- The security function of the unit restricts playback from the S folder, but does not encrypt files.
- The capacity of the security area is 128 MB.
- You can record files in and delete files from the security area (the S folder) even if the security function is turned on.

About the public area and the security area

The unit features the public area and security area. Each area contains the following folders:

- **Public area** — A, B, C, D, L and M folders: For normal recording and playback
- **Security area** — S folder: Playback from this folder can be locked via passcode.

About playback in the security area (S folder)

When security lock is on: You must enter the passcode to release the security lock to play back files.

When security lock is off: You can play back files in this folder in the same way as in the public area.

Turning the security lock on and off

Turning the security lock on

1. While the unit is stopped, press the MENU/STOP button for at least two (2) seconds.
2. Press the ►► or ◀◀ button to select "COMMON", then press the ► button.
3. Press the ►► or ◀◀ button to select "SECURITY ON", then press the ► button.
4. Press the ►► or ◀◀ button to select a number for the first digit, then step to the next digit by pressing the ► button. You can set any four-digit number from 0000 to 9999 as the passcode. (The factory-set passcode is 0000.)
5. Enter a number for digits 2 to 4 in the same way.

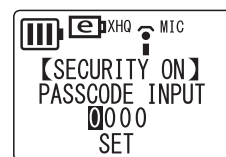

6. Make sure that "SET" is highlighted, then press the ► button.



7. Write down your passcode, then press the ► button.
Keep your passcode in a safe place.



Turning the security lock off

1. While the unit is stopped, press the MENU/STOP button for at least two (2) seconds.
2. Press the ►► or ◀◀ button to select "COMMON", then press the ► button.
3. Press the ►► or ◀◀ button to select "SECURITY OFF".

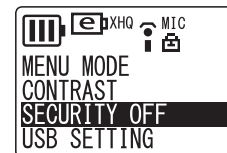

4. Press the ►► or ◀◀ button to select a number for the first digit of your passcode, then step to the next digit by pressing the ► button.
5. Enter a number for digits 2 to 4 of your passcode in the same way.
6. Make sure that "RESET" is highlighted, then press the ► button.
After you turn off the security lock, the passcode returns to "0000", which is the factory default.

Playing back a file in the locked S folder

1. While the unit is stopped, press the FOLDER/INDEX button for at least two (2) seconds to select the S folder, then press the ► button.

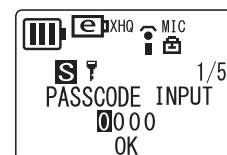

2. Press the ►► or ◀◀ button to select a number for the first digit of your passcode.

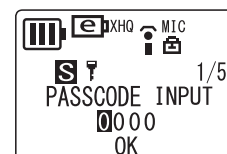

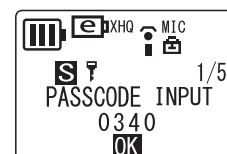

3. Enter a number for digits 2 to 4 of your passcode in the same way.
4. Make sure that "OK" is highlighted, then press the ► button.
Playback begins.



Note:

- Reformat the security area of the unit if you have lost your passcode. (When you format the security area, all files in the S folder are deleted, the security lock is turned off, and the passcode returns to "0000" which is the factory default.)
- To lock the security folder again, turn off the power and then turn the power back on.

Security setting and icons

Security		Icon		S folder		
				Playback	Recording	Deleting
Off		-		✓	✓	✓
On	Locked			-	✓	✓
	Unlocked	-		✓	✓	✓

✓ : Available

- : Not available

Returning to the public area folders

While the unit is stopped, press the FOLDER/INDEX button for at least two (2) seconds.

Setting the menu options

General procedure for setting menu options

1. While the unit is stopped, press the MENU/STOP button for at least two (2) seconds.
The first level of the menu option hierarchy appears.

2. Press the ►► or ◀◀ button to select the desired option.

VOICE:	Settings for audio recording
MUSIC:	Settings for music playback
COMMON:	Common (global) settings

3. Press the ► button.
The second level of the menu option hierarchy appears.

4. Press the ►► or ◀◀ button to select the desired option.

VOICE menu:

"DIVIDE" ↔ "REC MODE" ↔ "MIC ALC" ↔ "MIC SENS." ↔ "VAS" ↔ "STEREO WIDE" ↔ "REC SELECT" ↔ "AUTO DIVIDE" ↔ "DIVIDE" ↔ ...

Note:

- "DIVIDE" cannot be selected if the MUSIC folder has been selected.
- "MIC SENS." cannot be selected if "MIC ALC" has been turned off.
- "VAS" cannot be selected if "MIC ALC" has been turned off.

MUSIC menu:

"SOUND EQ" ↔ "BASS" ↔ "REPEAT" ↔ "SOUND EQ" ↔ ...

COMMON menu:

"BEEP SOUND" ↔ "DATE & TIME" ↔ "BATTERY SETTING" ↔ "TIMER & ALARM" ↔ "FORMAT" ↔ "REC LED" ↔ "BACKLIGHT" ↔ "AUTO POWER OFF" ↔ "MENU MODE" ↔ "CONTRAST" ↔ "SECURITY ON" ↔ "USB SETTING" ↔ "VERSION" ↔ "BEEP SOUND" ↔ ...

5. Press the ► button.
6. To edit the setting of the selected menu option, press the ►► or ◀◀ button, then press the ► button.
The second level of the menu option hierarchy is displayed again.

Note:

- To return to the second level of the menu option hierarchy without changing the setting, press the MENU/STOP button once during the menu setting procedure. The setting is cancelled and the menu options are displayed.

7. Press the MENU/STOP button twice to exit menu setting mode.

VOICE menu options

DIVIDE: Divides a file.

You can use the Divide function to get rid of unnecessary parts and keep only those you desire. To divide a file, you must first locate the desired position (time) by playing back the file up to that position.

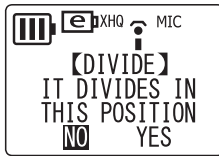

NO: Returns to menu setting mode.

YES: Divides the file at the current stop position.

Note: _____

- Once a file is divided, it cannot be joined together again.
 - Short files or files in the M (music) folder cannot be divided.
 - A few seconds at the division point of each of the divided parts will overlap.
 - If a file that includes index marks is divided, all index marks will be deleted.
-

REC MODE: Selects the recording mode ([page 9](#)).

MIC ALC: Enables the microphone's Auto Level Control function ([page 12](#)).

MIC SENS.: Selects the microphone's sensitivity (effective only for microphone recording when the MIC ALC function is turned on) ([page 13](#)).

VAS: Enables VAS recording (effective only for microphone recording when the MIC ALC function is turned on) ([page 15](#)).

STEREO WIDE: Selects Stereo wide (effective only for microphone recording).

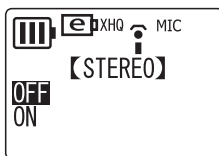

OFF: Stereo wide off

ON: Stereo wide on

Note: _____

- This function does not work while "recording mode" is set to "LP".
-

REC SELECT: Selects the external recording mode ([page 6](#) for the "MIC" setting, and [page 16](#) for the "LINE" setting).

AUTO DIVIDE: Automatically divides a file (effective only for the line-in setting) ([page 17](#)).

MUSIC menu options

SOUND EQ: Selects the equalizer function (effective only for playback through headphones).



OFF: Equalizer is off.

POP: Emphasizes the high range.

ROCK: Emphasizes high and low ends.

JAZZ: Emphasizes the mid range.

BASS: Emphasizes the bass sound (effective only for playback through headphones).

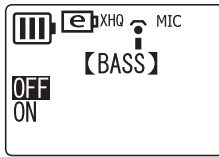

OFF: Bass function is off.
ON: Bass function is on.

REPEAT: Selects the repeat/random mode (page 22).

COMMON menu options

BEEP SOUND: Selects the beep sound.



OFF: Beep sound is off.
ON: Beep sound is on.

DATE & TIME: Sets the date and time (page 7).

BATTERY SETTING: Selects the battery type (page 5).



ene loop: Rechargeable Ni-MH battery (supplied).
ALKALINE : AAA/LR03/HP16 alkaline battery.

TIMER & ALARM: Sets timers (page 25).

FORMAT: Formats the internal memory (deletes all files in all folders) (page 24).

REC LED: Selects the LED function for recording.

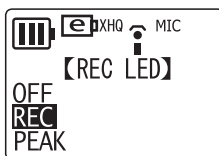

OFF: LED is off.
REC: LED operates as recording indicator.
PEAK: LED operates as peak indicator.

Note:

- *PEAK can be selected only when you set MIC ALC to OFF. If you select PEAK with MIC ALC "ON", REC LED will remain OFF.*

BACKLIGHT: Turns on the backlight.

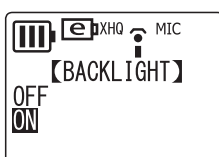

OFF: Backlight is off.
ON: Backlight is on.

AUTO POWER OFF: Enables the Auto Power Off function (page 6).

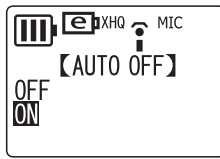

OFF: The function is off.
ON: The function is on.

MENU MODE: Selects the menu mode.

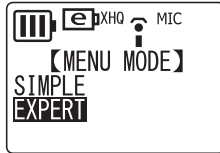

SIMPLE: Displays only the basic menu options (REC MODE, SOUND EQ, BASS, BEEP SOUND, DATE & TIME, BATTERY SETTING, VERSION and MENU MODE).
EXPERT: Displays all menu options.

CONTRAST: Adjusts the contrast of the LCD display.

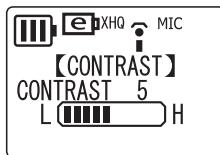

L (1) ↔ (10) H

SECURITY ON: Turns on the Security function (page 28).

USB SETTING: Selects the USB connection mode (page 35).

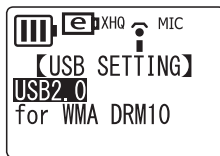

USB2.0: Standard USB connection
for WMA DRM10: Connection mode for WMA DRM10.

VERSION: Displays the unit's version number.

Switching among different display indicators

While the unit is stopped, press the MENU/STOP button repeatedly. The display changes in the following sequence:

In the VOICE (A, B, C, D, S) and L (Line) folder:

Remaining recording time → Current date/time → Total playing time (if there is a file) → Recorded date/time (if there is a file) → Remaining recording time → ...

In the M (Music) folder:

Artist/Title name (if there is a file) → Current date/time → Total playing time (if there is a file) → Artist/Title name →

Note: _____

· Artist name and title may not be displayed for some music files.

Connecting to a Computer

Computer system requirements

Windows

Computer	Windows-based computer with built-in USB interface
OS	Windows Vista, XP
Others	Speakers or headphones Sound playback function

Macintosh

Computer	Macintosh computer with built-in USB interface
OS	Mac OS X 10.4, 10.5
Others	Speakers or headphones Sound playback function

Note:

- For latest information about the minimum system requirements, check the web site below.
<<http://www.yamahasyth.com/>>

Connecting the unit to your computer

You can connect the USB terminal on the recorder directly to a USB connector on your computer. Open the USB terminal cover on the recorder, use the USB terminal slide switch to extend the USB terminal, then insert the extended USB terminal in the correct orientation into a USB connector on your computer.



Do not apply force to the terminal. Otherwise, it may break. If necessary, use the supplied USB cable.

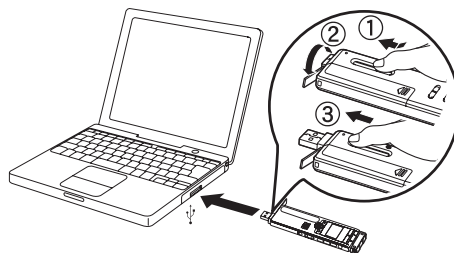

Take note of the orientation of the terminal.

About the USB connection

In the menu settings, you can select either "USB2.0" or "for WMA DRM10" as an USB connection mode (page 34).

USB2.0: Select this mode in most cases, and specifically to transfer files to a computer or to use the unit as a USB flash memory.

for WMA DRM10: Select this mode to transfer DRM10 content WMA files to the unit.

Note:

- To transfer non-DRM10 content files, select "USB2.0" mode.
 - To use the "for WMA DRM10" connection, you must have Windows Media Player 10 or later for Windows XP SP2, or Windows Media Player 11 or later for Windows Vista installed on your computer.
-

 **Hint:**

DRM (Digital Rights Management) 10 is a copy-protection format designed to protect intellectual property (for example, music) from illegal copying and distribution. In order to play WMA files protected by this format, you must first set the unit to "for WMA DRM10," then connect the unit to the computer and transfer the WMA files.

Precautions when using the USB terminal

When connecting the USB terminal to the computer, make sure to observe the following points. Failing to do so risks freezing the computer and corrupting or losing the data. If the computer or the unit freezes, restart the application software or OS, or turn the power to the unit off then on again.



- Before connecting the USB terminal to the computer, exit from any power-saving mode of the computer (such as suspended, sleep, standby).
- Execute the following before turning the power to the unit on/off or plugging/unplugging the USB terminal.
 - Make sure that no read or write operations are in progress.
 - Safely remove the unit from the computer after closing all windows that accessed the unit.
- While the unit is connected to the computer, you should wait for six seconds or more between these operations: (1) when turning the power of the unit off then on again, or (2) when alternately plugging/unplugging the USB terminal.

Note:

- When you connect the recorder to the computer for the first time, some computers may not immediately recognize the unit as a Removable Disk. In this case, disconnect the unit and reconnect it again.
 - While the unit is connected to the computer, the unit will operate without consuming battery power.
-

Selecting the Windows action

When you connect the unit to a computer, the system displays the following window:

Note:

- The following description applies to the "USB2.0" mode (normal USB connection).
- The screens, the menu items and buttons displayed on your computer may not exactly match those shown in this manual, depending on the OS version or manufacturer of your computer. (The screens shown in this manual are of Windows XP.)

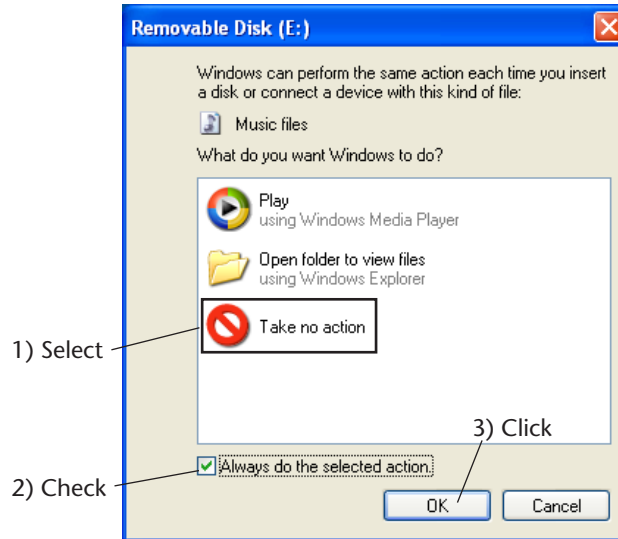

Select an option that would suit your computer's environment.

In this example, [Take no action] is selected, [Always do the selected action] is checked, and [OK] is clicked. This completes the connection to the computer.

When connected to the computer, the unit will display the following indicators, and all buttons will be disabled.

Connected to PC



Transmitting to/from PC



Before disconnecting the unit from the computer, be sure to follow the steps on the next page. Do not disconnect the unit from the computer during data transfer.

Disconnecting the unit from your computer

 Before disconnecting the unit from your computer, make sure that no data is being transferred.

Follow the steps below to disconnect.

1. Right-click the device icon on the taskbar at the bottom right of the Windows screen to pop up the menu option [Safely Remove Hardware].
If the icon is not displayed, refer to Windows Help.
2. Click [Safely Remove Hardware].

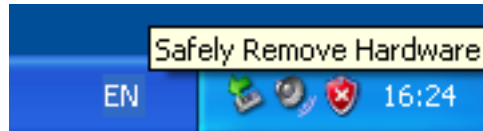

3. Select [USB Mass Storage Device] and click [Stop].
4. Make sure that [Yamaha Pocketrak USB Device] is in the list, then select [USB Mass Storage Device] and click [OK].
5. Disconnect the unit from your computer.

Recharging the enloop



- Be sure to insert and recharge the enloop. Do not attempt to recharge alkaline batteries. Otherwise, the battery liquid may leak and damage the unit.
- Recharge the enloop at an ambient temperature between 5 and 35 degrees Celsius (41 and 95 degrees Fahrenheit).

Before recharging the enloop

- Make sure that the BATTERY SETTING is set to "enloop." (page 33)
- Be sure to close the battery cover before you start recharging.

Recharging the enloop

1. Connect the unit to your computer. (page 35)
2. While the LCD screen on the recorder indicates that the unit is connected to the computer, press the  button for at least two seconds.

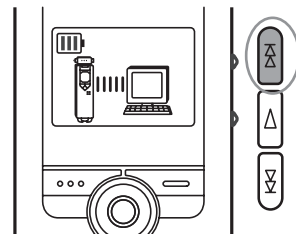

The REC/PEAK LED lights up and recharging starts. When the battery is recharging, the battery indicator on the LCD screen changes in the following sequence:

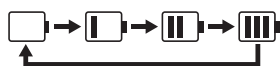

When recharging is complete, the REC/PEAK LED turns off.

Note:

- Recharging takes approximately 90 minutes.
- The recharging time is an approximate value based on a full recharge of a fully drained eneloop battery. The recharging time will vary depending on the power left in the battery and the ambient temperature.
- You can recharge the eneloop during data transfer. However, depending on how you use the unit, the battery may be exhausted more quickly.



- The battery may become warm during recharge, but this is normal.
- The battery life has come to an end if the battery is exhausted relatively quickly even after being fully recharged.

The recharging operation may not start for one of the following reasons. In such cases, a crossed-out battery icon will appear.

- A non-eneloop battery has been loaded.
- There is no battery in the unit.
- The unit is overheated.

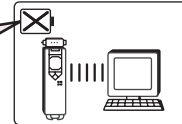

3. Disconnect the unit from your computer. (page 38)

Canceling the recharge operation

To cancel the recharge operation, press the ►► button for at least two seconds while recharging.

Viewing removable disks via Explorer

Starting Explorer

To view removable disks via Explorer as shown in this manual, start Windows Explorer as follows:

Click [start], then right-click [My Computer], and select [Explorer] from the menu that appears.

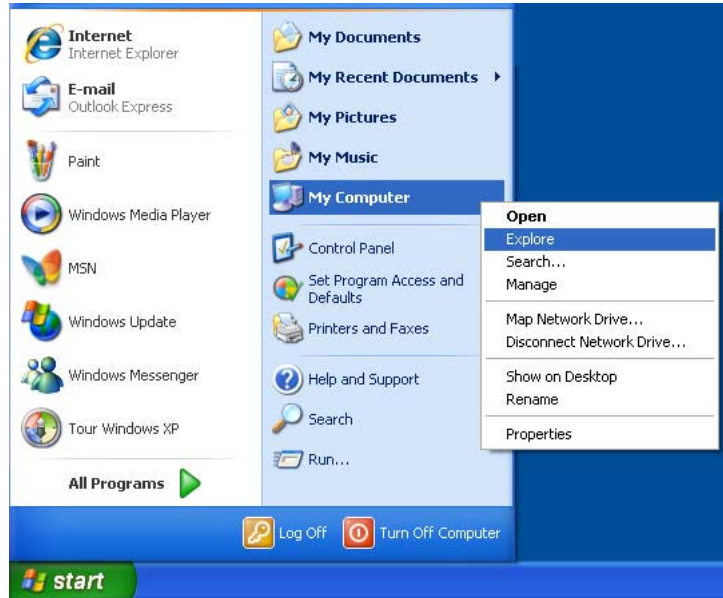

Explorer will start.



Do not format the internal memory from the computer. Doing so may render the unit unable to record. If you have already formatted the internal memory from the computer, format it again on the unit.

About the folder in Removable Disk

When you connect the recorder to your computer, Removable Disk icons will appear in the My Computer directory folder in Windows.

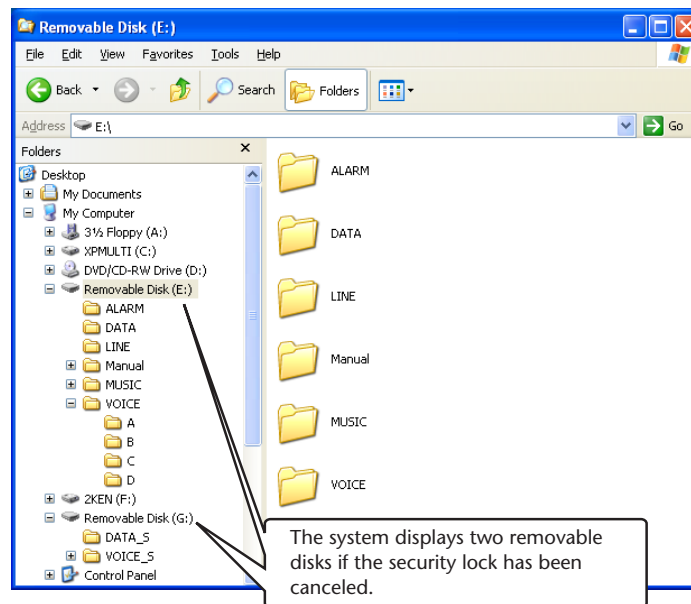

[VOICE] and [VOICE_S] folders

These folders store files recorded by the unit.

The [VOICE] folder contains sub-folders A-D (VOICE).

- Files recorded and stored in the A folder inside the VOICE folder are named "IC_A_XXX (file number).MP3" or "IC_A_XXX (file number).WAV".
- The same naming rule applies to the B, C, and D folders.
- Each of the A, B, C, D, and S folders accommodates up to 99 files.
- You can play back only the files (in the VOICE folder) that comply with the file naming rules for folders A through D.
For example, if you move file IC_B_001.MP3 from the B folder to the A folder, you will be unable to play the file.

Also, keep in mind that if you change the name of a file on the computer, then move the file back to the VOICE or VOICE_S folder, you will be unable to play the file on the unit. However, if you transfer the file to the MUSIC folder instead, you will be able to play the file on the unit.

[MUSIC] folder

This folder stores files transferred from your computer.

- There are no naming rules applied to files that are transferred from a computer. However, the files must be in MP3 or WMA format.
- The playback sequence may change if you add files to the MUSIC folder, or if you create a sub-folder inside the MUSIC folder.
- You can create sub-folders inside the MUSIC folder and move files to those sub-folders.

[DATA] and [DATA_S] folders

These folders store data files (Excel, Word, etc.) as a Removable Disk. The system displays the DATA_S folder if the security lock has been canceled.

[Manual] folder

This folder stores the PDF manual files in each of the language folders (English/German/French/Spanish/Italian/Russian).

- Each of the language folders contains the owner's manual (supplied) and the reference manual (PDF only).
- In order to view the PDF files, Adobe Reader must be installed in your computer.

Note:

- If you format the unit, the Manual folder will be deleted. You can download the latest PDF manual files from the following Yamaha website.
<http://www.yamaha.co.jp/manual/>

[ALARM] folder

This folder stores MP3/WMA files (excluding DRM contents) that can be played as an alarm.

- If the ALARM folder is empty, a beep will be used as the alarm.
- Only one file can be used as an alarm at a time.

[LINE] folder

This folder stores files recorded from external devices.

- Files recorded and stored in the LINE folder are named "IC_L_XXX (file number).MP3".
- The LINE folder accommodates up to 199 files.
- You can play only those files (in the LINE folder) that comply with the file naming rules.

Security setting and removable disk display

The following table shows the relationship between the security setting status and the removable disk display when the unit is turned on and connected to the computer:

Security		PUBLIC AREA	SECURITY AREA (DATA_S, VOICE_S)
Off		✓	✓
On	Playback locked	✓	—
	Playback unlocked	✓	✓*

✓ : Displayed

— : Hidden

* Since the playback function is automatically locked when the unit is turned off, the unit's removable disk icon will not be displayed if you connect the unit while its power is turned off.

Using the unit as a music player

You can use the unit as a music player to enjoy listening to music. To do so, you must first record music files on your computer, then transfer them to the unit.

Recording music files

There are the two methods that will enable you to use the unit as a music player:

- Ripping CDs (see below on this page) on the computer → Copying data to the unit using Explorer ([page 46](#))
- Using a music distribution service through the Internet → Transferring data using Windows Media Player ([page 47](#))

If you have installed Microsoft Windows Media Player on your computer, you can transfer WMA/MP3 files to the unit. See Windows Media Player online help for details on how to transfer files.

Microsoft Windows Media Player can be downloaded from the following website:
<http://www.microsoft.com/windows/windowsmedia/>

Note:

- The unit can play back music files only if they are in WMA or MP3 format.
- Copying, distributing or posting on the Internet commercially-available music files or data is strictly prohibited, except in cases limited to your personal use.
- Yamaha makes no representations or warranties with regard to the content of files, and cannot be held responsible for the failure of transfers or downloads, or for damage or erasure of music files due to malfunction of the unit or your computer.
- The screens, the menu items and buttons displayed on your computer may not exactly match those shown in this manual, depending on the OS version or manufacturer of your computer. (The screens shown in this manual are of Windows XP / Windows Media Player 10.)

Ripping CDs (transferring music files to your computer)

This section explains how to rip music files (MP3 or WMA) from CDs to your computer using Microsoft Windows Media Player. For detailed information about this operation, see the Windows Media Player online help.

1. Select [Start] menu → [All programs] → [Windows Media Player] to start Windows Media Player.

Alternatively, select [Start] menu → [All programs] → [Accessories] → [Entertainment] → [Windows Media Player].

2. Click [Rip] tab.

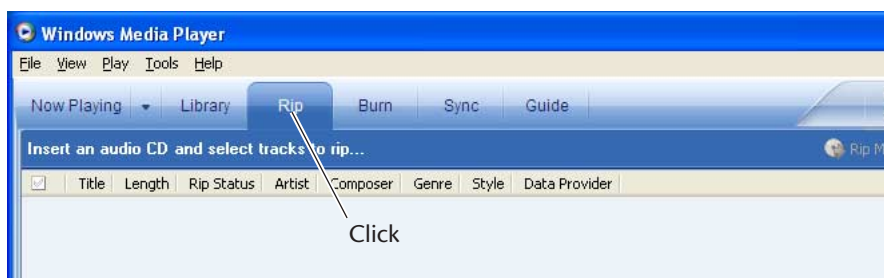

3. Insert a CD into the CD-R/RW drive.

Note:

- If your computer has access to the Internet, the system will automatically obtain and display music information related to the CD.

4. Click [▼] → [Tools] → [Options].

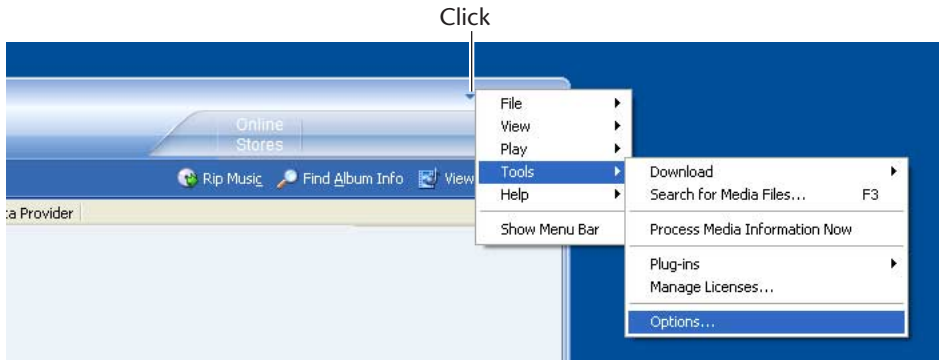

5. Select the [Rip Music] tab.

6. Make sure that [Copy protect music] is NOT checked, then click [OK].

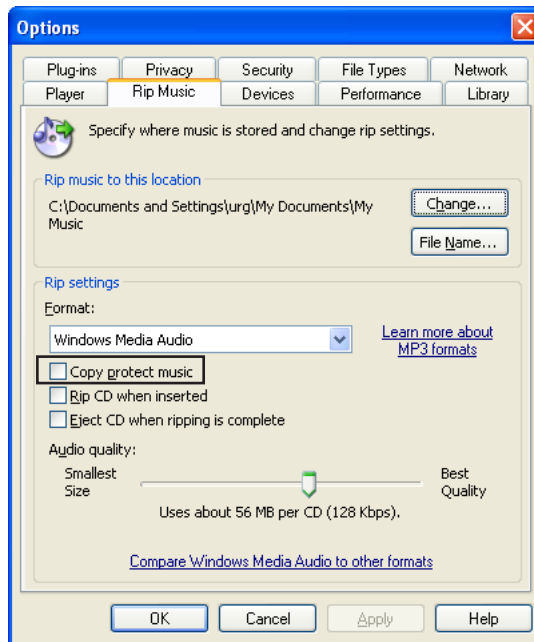

7. Check the box of the songs that you wish to rip to your computer, then click [Rip Music].

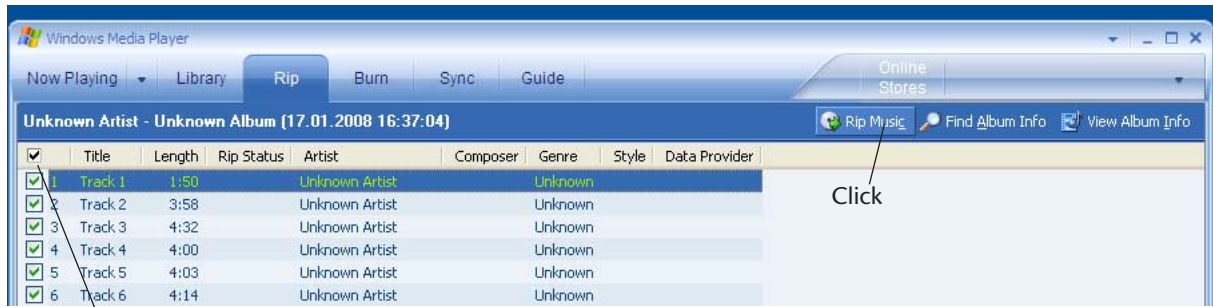

Check

The system starts ripping the CD.

Note:

- Some MP3/WMA files may not play on the unit.
- Copying, reproducing or distributing MP3 or WMA files, except in cases limited strictly to your personal use, is prohibited without the permission of the copyright holders as stipulated by intellectual copyright laws.

Copying data using Explorer

This section explains how to transfer MP3/WMA files to the unit using Windows Explorer.

1. Connect the unit to the USB terminal on the computer.
2. Start Explorer on the computer (page 40).
3. Open the "MUSIC" folder in the Removable Disk drive and the "My Music" folder in "My Document" on the computer.

(1) Copying files to the unit

Select the MP3/WMA files (other than DRM content) that you wish to copy, then "drag and drop" them to the MUSIC folder in the Removable Disk drive.

(2) Copying files to your computer

Select the MP3/WMA files you wish to copy in the MUSIC folder on the Removable Disk, then "drag and drop" them into a folder of your choice on your computer.

Note:

- If you want to transfer to the unit WMA files purchased via a music distribution service, use Windows Media Player (page 47).

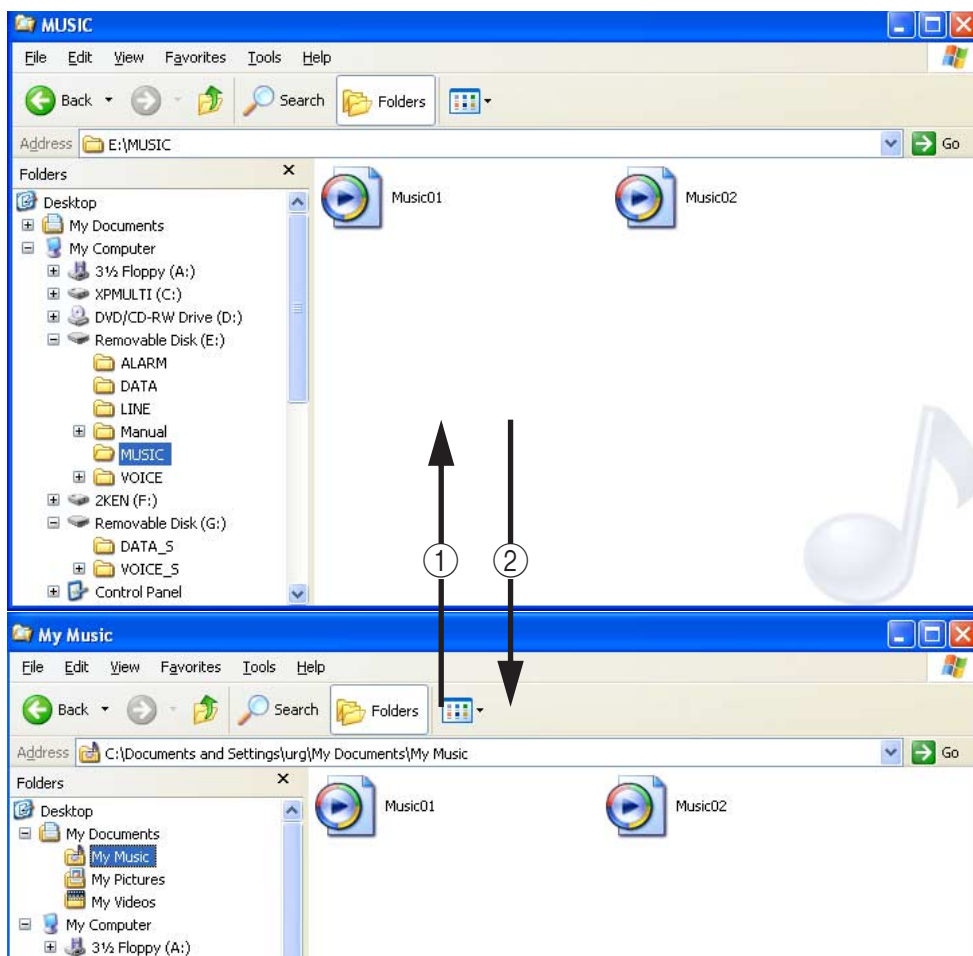

Transferring data using Windows Media Player

This section explains how to transfer MP3/WMA files to the unit using Windows Media Player.

Select [Start] menu → [All programs] → [Windows Media Player] to start the program.

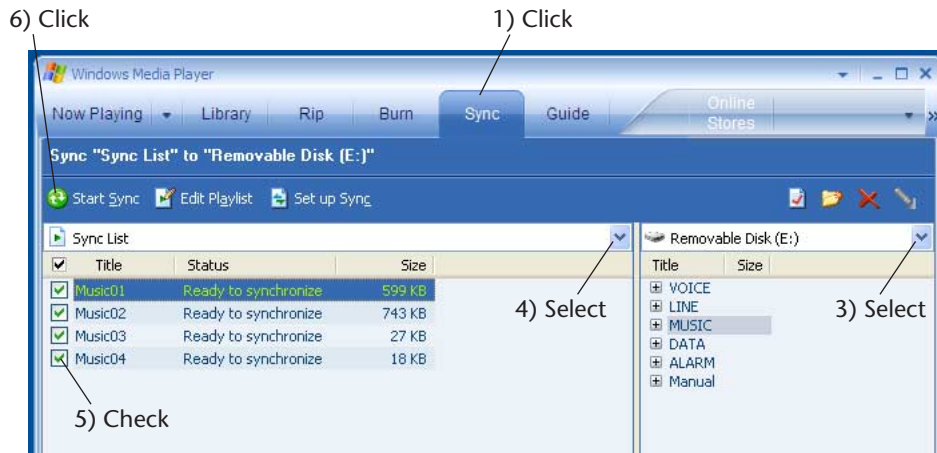

1. Click [Sync] tab.

When you transfer DRM10 content WMA files to the unit, set USB SETTING to "for WMA DRM10" (page 35).

2. Connect the unit to the computer.

Note:

· If the system displays "Device Setup" window, select "Manual", then click [Finish].

3. Select [Removable Disk] (if "USB2.0" has been selected) or [Digital Voice Recorder] (if "for WMA DRM10" has been selected) from the pull-down menu on the right side to display the files.

4. Select [All Music] from the "Sync List" pull-down menu.

5. Check the box for the songs that you wish to transfer to the unit.

6. Click [Start Sync].

The system starts synchronizing to the device.



Never disconnect the unit from your computer during file transfer.

Creating a Playlist

You can create a Playlist to play back tracks in the MUSIC folder in the desired sequence. This section explains how to create a Playlist on your computer and transfer it to the unit.

1. Select the [Start] menu → [All programs] → [Accessories], then open [Notepad].

Playlist example:

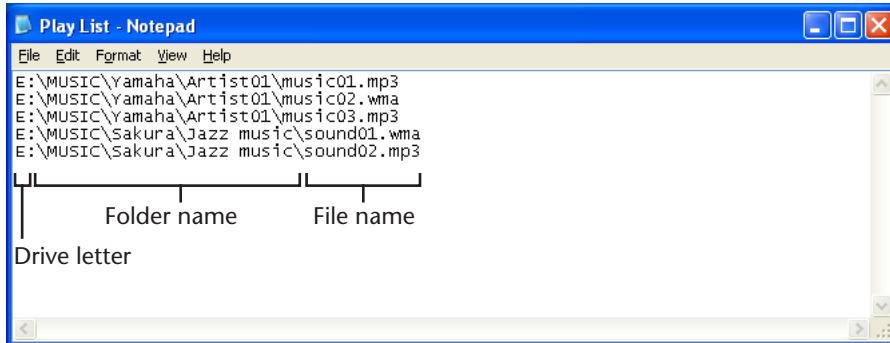

2. Enter the file names included in the MUSIC folder into the Playlist in the desired sequence.

Note: _____

- File names must be 200 characters or shorter.
 - You can specify the playback sequence of the files included in the MUSIC folder. However, you cannot specify the sequence of the files in the VOICE folders.
 - It may not be possible to specify a playback order for files in certain formats.
-

3. Save the Playlist file with a name "XXX (file name).m3u."
4. Transfer the Playlist file to the MUSIC folder on the unit using Explorer.
5. Disconnect the unit from the computer.

Selecting the Playlist:

1. Press the FOLDER/INDEX button to select the M (MUSIC) folder.
2. Press the ►► or ◀◀ button to select the desired Playlist, then press the ► button.
3. Press the ► button again to start playback of the Playlist.
"PL" appears on the display.

Note: _____

- To cancel the Playlist playback, press the FOLDER/INDEX button while the unit is stopped.
-

Appendix

Troubleshooting

The unit does not operate.

Possible cause	Battery is not inserted properly or is dead.
Corrective action	Reinsert the battery correctly. Recharge the eneloop or replace with a new alkaline battery.

Possible cause	Internal memory error.
Corrective action	Format (initialize) the internal memory and then try recording again.

Buttons do not work.

Possible cause	The Hold function is set.
Corrective action	Turn off the function.

Possible cause	The USB terminal is still connected to the computer.
Corrective action	Disconnect the unit from the computer.

No sound.

Possible cause	The volume is turned down too low.
Corrective action	Adjust the volume.

Files in the VOICE (A, B, C, D, S) or L (line) folder cannot be played.

Possible cause	The file name is wrong.
Corrective action	If you modify the file name using your computer, the file may become unplayable. Correct the file name to "IC_X(folder name)_XXX (file number).MP3" or "IC_X_XXX.WAV".

Files in the M (music) folder cannot be played (correctly or at all).

Possible cause	The file is not in a playable format.
Corrective action	Use MP3/WMA-format files.

Possible cause	Files on the PC were not transferred to the MUSIC folder.
Corrective action	Transfer the files to the MUSIC folder on the Removable Disk.

Possible cause	You attempted to play a data file, which cannot be played on the unit.
Corrective action	Create a file using different encoder (MP3/WMA conversion) software.

Cannot play back files in the Playlist folder, and the unit displays "- M - - S".

Possible cause	Music files you have erased remain in Playlist.m3u.
Corrective action	Delete music files you have erased from Playlist.m3u (page 48).

The Removable Disk is not displayed when the unit is connected to the PC.

Possible cause	The unit is not connected to the PC correctly.
Corrective action	Make sure the connection is correct. Disconnect the unit from the PC and reconnect it again.

Possible cause	Sufficient power is not being supplied from the PC to the unit.
Corrective action	If a USB hub is being used, reconnect the unit directly to the USB terminal on the PC. If the PC is equipped with several USB terminals, try another terminal.

Possible cause	A network drive has been assigned.
Corrective action	If a network drive has been assigned, the drive letter (the letters used as drive names) is already taken, so the Removable Disk cannot be created. Change the network drive assignments and reconnect the unit. Talk to your network administrator about reassigning network drives.

Possible cause	Playback is locked with the security setting turned on.
Corrective action	Cancel the playback lock and connect the unit to the PC with the unit's power turned on.

Cannot recharge the eneloop.

Possible cause	The BATTERY SETTING is set to "ALKALINE."
Corrective action	Set the BATTERY SETTING to "eneloop" (page 33).

Possible cause	Connecting the unit to the PC does not cause the battery to be recharged.
Corrective action	Press the ►► button for at least two (2) seconds (page 38).

A file can't be erased.

Possible cause	The attribute of the file is set to "read only."
Corrective action	Connect the unit to the PC and change the file attribute or erase the file from the PC. Alternatively, format (initialize) the built-in memory.

[ERROR FILE SYSTEM] is displayed and nothing else happens.

Possible cause	FAT administration system error.
Corrective action	Format (initialize) the built-in memory.

Cannot select the S folder.

Corrective action	Press and hold down the FOLDER/INDEX button while the unit is stopped. See "Playing back a file in the locked S folder" on page 29.
-------------------	---

Icon "⊠" appeared when you attempted to recharge the battery.

Possible cause	You attempted to recharge a battery other than the eneloop. You attempted to recharge the battery, but the battery had not been inserted.
Corrective action	Insert the eneloop battery into the unit.

Possible cause	The unit is overheated.
Corrective action	Disconnect the unit from the PC, let the unit cool down for a while, then try to recharge again.

Cannot divide a file.

Possible cause	There may be insufficient free memory.
Corrective action	Erase unnecessary files. See “Deleting the selected file” on page 23.

Possible cause	The file is too short to divide.
Corrective action	You can divide only files that exceed a specific minimum recording time. PCM...about one sec or longer XHQ...about four sec or longer HQ.....about eight sec or longer SPabout 16 sec or longer LP.....about 32 sec or longer

The file transfer speed (from PC to unit) is slow.

Possible cause	The unit is connected to the USB1.1 terminal.
Corrective action	Connect the unit to a USB2.0 High Speed terminal.

Recordings include unwanted noise.

Possible cause	Recording mode or microphone sensitivity may not be appropriately set.
Corrective action	Change the recording mode or microphone sensitivity and try to record again. Determine the optimum setting for your recording environment. See “Selecting the recording mode” on page 9 and “Selecting the microphone sensitivity” on page 13. Format (initialize) the internal memory. See “Formatting (Deleting all files in all folders)” on page 24.

“Connection” icon does not appear when the unit is connected to the PC.

Corrective action	Some computers may not cause the icon to be displayed on the unit, or may not recognize the unit. Disconnect the unit from the PC, then reconnect it.
-------------------	---

The calendar does not show the correct date and time.

Corrective action	Set the date and time again. See “Date and time settings” on page 7.
-------------------	--

The playback is missing a small portion at the beginning of the file.

Possible cause	In order to minimize noise, 0.1 seconds from the beginning of the file is faded-in for playback (the volume will gradually increase).
Corrective action	If you’re using this device to play back a file that was created using DAW software such as Cubase AI, insert a blank space of at least 0.1 seconds at the beginning of the file when creating it.

FAQ

Q: May I use a manganese battery?

A: Do not use a manganese battery or NiCad battery. You may use an oxyride battery, but the battery life would be about the same as that of alkaline batteries.

Q: Why do I hear a rustling noise in the recordings?

A: A rustling noise may be recorded if you move the unit during recording, or even if you move your fingers while holding the unit when recording. If possible, try not to move the unit during recording.

Q: How can I store the recordings onto tapes or MDs?

A: Use a standard audio cable (with 3.5mm mini plugs) to connect the unit to your tape recorder or MD recorder, then dub the recordings to a tape or MD.

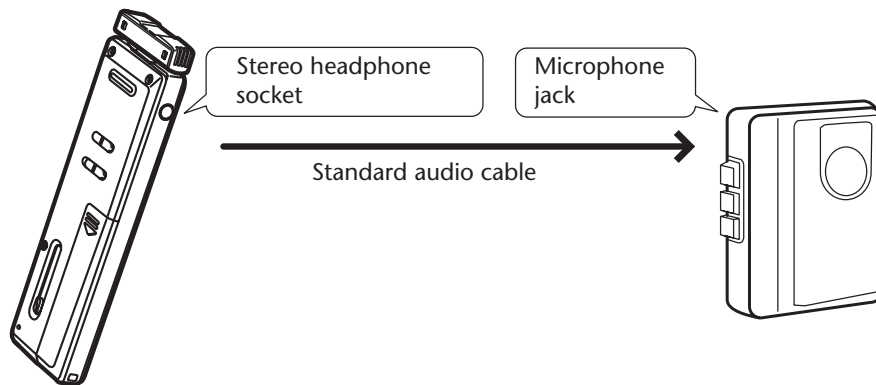

Compatible audio cable

Jack on the external recorder	Audio cable
Microphone input	3.5-inch mini plug, with resistance
Line input	3.5-inch mini plug, without resistance

- Use a stereo audio cable.
- Before dubbing the recordings, try a test dubbing and adjust the dubbing level on the unit.
- You can also dub the recordings from your tape or MD player to the unit (page 16).

Q: Does the available recording time specified in the the manual apply to each file?

A: No. The available recording time in each recording mode refers to the total time available for recording without changing the recording mode, and assuming that no recording files exist in the memory. For example, if you record one file until the memory is full, you cannot record further even if you change the file or folder.



Q: Are there any tips to making a good recording?

A: Try a test recording to set the optimum recording mode and sensitivity, since the recording condition varies with the location and circumstance.

Q: I cannot play back a recorded file that was stored on the PC and transferred back to the unit.

A: You may have changed the file name on the PC. If you change the file name, the file will not play, even if it is transferred back into the VOICE folder. However, you will be able to play the file if you transfer it into the MUSIC folder.

Specifications

Internal Memory:	2GB
Recording Time (total time of A, B, C, D and S folder):	Approx. 3hr.5min. (PCM) Approx. 27hr.40min. (XHQ) Approx. 68hr. (HQ) Approx. 136hr. (SP) Approx. 272hr. (LP)
Frequency Response (overall):	40 Hz - 20 kHz (Built-in microphones, PCM) 40 Hz - 15 kHz (Built-in microphones, XHQ) 40 Hz - 7.5 kHz (Built-in microphones, HQ) 40 Hz - 3.5 kHz (Built-in microphones, SP) 40 Hz - 3.5 kHz (Built-in microphones, LP)
Recording Format:	MP3, PCM
Playback Format:	MP3 (MPEG-1 LAYER-3, MPEG-2 LAYER-3, MPEG-2.5 LAYER-3), WMA, PCM (only files recorded on this device)
Frequency Response (playback):	20 Hz - 20 kHz
Sampling Frequency:	44.1 kHz (PCM, XHQ) 22.05 kHz (HQ) 11.025 kHz (SP) 16 kHz (LP)
Bit Rate (recording):	1411 kbps, 16 bit (PCM) 160 kbps, 128 kbps (S folder) (XHQ) 64 kbps (HQ) 32 kbps (SP) 16 kbps (LP)
Bit Rate (playback):	MP3 (16 - 320 kbps) WMA (32 - 192 kbps) (Some files may not be playable on this device.)
Connectors:	USB,  (Headphones),  (Microphone)
Operating Temperature:	+5°C – +35 °C (+41°F – +95°F)
Output Power (headphones):	10mW + 10mW (at 16Ω load)
Power Supply:	DC 1.5V (“eneloop” or “AAA/LR03/HP16” alkaline battery x 1)
Battery Life:	<p>Continuous Recording</p> <ul style="list-style-type: none"> SP: Approx. 25 hr. (alkaline) Approx. 19 hr. (eneloop) PCM: Approx. 9 hr. (alkaline) Approx. 8 hr. 30 min. (eneloop) <p>(when the recording LED and backlight are OFF and without head-phone monitoring)</p> <p>Continuous Playback (headphones)</p> <ul style="list-style-type: none"> MP3: Approx. 22 hr. (alkaline) Approx. 17 hr (eneloop) PCM: Approx. 9 hr. 30 min. (alkaline, eneloop) <p>(when the backlight is OFF)</p> <p>Continuous Playback (speaker)</p> <ul style="list-style-type: none"> MP3: Approx. 14 hr. (alkaline) Approx. 11 hr. (eneloop) PCM: Approx. 6 hr. (alkaline, eneloop) <p>(when the backlight is OFF)</p>
Dimensions (W x H x D):	Approx. 34.2 x 119.5 x 13 mm
Weight:	Approx. 49 g (including “eneloop,” excluding soft case)
Included Accessories:	Owner’s Manual, earphones, USB connection cable, “eneloop” (Rechargeable Ni-MH battery), DVD-ROM, soft case, microphone stand adapter

- * Consecutive recording/playback time varies depending on the type and manufacturer of battery, storage condition, usage, ambient temperature, etc. The time value listed above is an estimate and is not guaranteed. Yamaha will not guarantee operation if you use any battery other than an alkaline battery or a rechargeable battery specified by Yamaha (eneloop).
- * The actual available capacity of the internal memory will be smaller than the one mentioned in the manual because the internal memory contains software necessary for the operation of the unit.
- * Due to the characteristics of the internal memory, the recording time can be shortened.
- * Specifications and descriptions in this manual are for information purposes only. Yamaha Corporation reserves the right to change or modify products or specifications at any time without prior notice. Since specifications, equipment or options may not be the same in every locale, please check with your Yamaha dealer.