

Electone® ***STAGEA***®

ELS-02

ELS-02C

Owner's Manual

PRECAUTIONS

PLEASE READ CAREFULLY BEFORE PROCEEDING

Please keep this manual in a safe and handy place for future reference.



WARNING

Always follow the basic precautions listed below to avoid the possibility of serious injury or even death from electrical shock, short-circuiting, damages, fire or other hazards. These precautions include, but are not limited to, the following:

Power supply/Power cord

- Do not place the power cord near heat sources such as heaters or radiators. Also, do not excessively bend or otherwise damage the cord, or place heavy objects on it.
- Only use the voltage specified as correct for the instrument. The required voltage is printed on the name plate of the instrument.
- Check the electric plug periodically and remove any dirt or dust which may have accumulated on it.

Do not open

- This instrument contains no user-serviceable parts. Do not open the instrument or attempt to disassemble or modify the internal components in any way. If it should appear to be malfunctioning, discontinue use immediately and have it inspected by qualified Yamaha service personnel.

Water warning

- Do not expose the instrument to rain, use it near water or in damp or wet conditions, place on it any containers (such as vases, bottles or glasses) containing liquids which might spill into any openings. If any liquid such as water seeps into the instrument, turn off the power immediately and unplug the power cord from the AC outlet. Then have the instrument inspected by qualified Yamaha service personnel.
- Never insert or remove an electric plug with wet hands.

Fire warning

- Do not put burning items, such as candles, on the unit. A burning item may fall over and cause a fire.

If you notice any abnormality

- When one of the following problems occur, immediately turn off the power switch and disconnect the electric plug from the outlet. Then have the device inspected by Yamaha service personnel.
 - The power cord or plug becomes frayed or damaged.
 - It emits unusual smells or smoke.
 - Some object has been dropped into the instrument.
 - There is a sudden loss of sound during use of the instrument.

CAUTION

Always follow the basic precautions listed below to avoid the possibility of physical injury to you or others, or damage to the instrument or other property. These precautions include, but are not limited to, the following:

Power supply/Power cord

- Do not connect the instrument to an electrical outlet using a multiple-connector. Doing so can result in lower sound quality, or possibly cause overheating in the outlet.
- When removing the electric plug from the instrument or an outlet, always hold the plug itself and not the cord. Pulling by the cord can damage it.
- Remove the electric plug from the outlet when the instrument is not to be used for extended periods of time, or during electrical storms.

Location

- Do not place the instrument in an unstable position where it might accidentally fall over.
- Do not place the instrument against a wall (allow at least 3 cm/one-inch from the wall), since this can cause inadequate air circulation, and possibly result in the instrument overheating.
- When transporting or moving the instrument, always use two or more people. Attempting to lift the instrument by yourself may damage your back, result in other injury, or cause damage to the instrument itself.
- Before moving the instrument, remove all connected cables, to prevent damage to the cables or injury to anyone who might trip over them.
- When setting up the product, make sure that the AC outlet you are using is easily accessible. If some trouble or malfunction occurs, immediately turn off the power switch and disconnect the plug from the outlet. Even when the power switch is turned off, electricity is still flowing to the product at the minimum level. When you are not using the product for a long time, make sure to unplug the power cord from the wall AC outlet.

Connections

- Before connecting the instrument to other electronic components, turn off the power for all components. Before turning the power on or off for all components, set all volume levels to minimum.
- Be sure to set the volumes of all components at their minimum levels and gradually raise the volume controls while playing the instrument to set the desired listening level.
- Only the provided speaker cord should be plugged to the electrical outlet under the keyboard unit. Do not plug any another cord other than the speaker cord; doing so can cause malfunction.

Handling caution

- Do not insert a finger or hand in any gaps on the key cover or instrument. Also take care that the key cover does not pinch your finger.
- Never insert or drop paper, metallic, or other objects into the gaps on the key cover, panel or keyboard. This could cause physical injury to you or others, damage to the instrument or other property, or operational failure.
- Do not rest your weight on, or place heavy objects on the instrument, and do not use excessive force on the buttons, switches or connectors.
- Do not use the instrument/device or headphones for a long period of time at a high or uncomfortable volume level, since this can cause permanent hearing loss. If you experience any hearing loss or ringing in the ears, consult a physician.

Using the bench (If included)

- Do not place the bench in an unstable position where it might accidentally fall over.
- Do not play carelessly with or stand on the bench. Using it as a tool or stepladder or for any other purpose might result in accident or injury.
- Only one person should sit on the bench at a time, in order to prevent the possibility of accident or injury.
- If the bench screws become loose due to extensive long-term use, tighten them periodically using the included tool.
- Keep special watch over any small children so that they don't fall off the rear of the bench. Since the bench does not have a backrest, unsupervised use may result in accident or injury.

Yamaha cannot be held responsible for damage caused by improper use or modifications to the instrument, or data that is lost or destroyed.

Always turn the power off when the instrument is not in use.

NOTICE

To avoid the possibility of malfunction/ damage to the product, damage to data, or damage to other property, follow the notices below.

■ Handling and Maintenance

- Do not use the instrument in the vicinity of a TV, radio, stereo equipment, mobile phone, or other electric devices. Otherwise, the instrument and/or other devices may generate noise. When you use the instrument along with an application on your iPad, iPhone or iPod touch, we recommend that you set “Airplane Mode” to “ON” on that device in order to avoid noise caused by communication.
- Do not expose the instrument to excessive dust or vibrations, or extreme cold or heat (such as in direct sunlight, near a heater, or in a vehicle during the day) to prevent the possibility of panel disfiguration, damage to the internal components or unstable operation. (Verified operating temperature range: 5° – 40°C, or 41° – 104°F.)
- Do not place vinyl, plastic or rubber objects on the instrument, since this might discolor the panel or keyboard.
- When cleaning the instrument, use a soft cloth. Do not use paint thinners, solvents, cleaning fluids, or chemical-impregnated wiping cloths.

■ Saving data

- Saved data may be lost due to malfunction or incorrect operation. Save important data to a USB flash drive.
- To protect against data loss through media damage, we recommend that you save important data you’ve created onto two USB storage devices.

Information

■ About copyrights

- Copying of the commercially available musical data including but not limited to MIDI data and/or audio data is strictly prohibited except for your personal use.
- This product incorporates and bundles computer programs and contents in which Yamaha owns copyrights or with respect to which it has license to use others' copyrights. Such copyrighted materials include, without limitation, all computer software, style files, MIDI files, WAVE data, musical scores and sound recordings. Any unauthorized use of such programs and contents outside of personal use is not permitted under relevant laws. Any violation of copyright has legal consequences. DON'T MAKE, DISTRIBUTE OR USE ILLEGAL COPIES.

■ About functions/data bundled with the instrument

- Various types/formats of music data can be used with this device, once the data is optimized to the proper format. However, as a result, this device may not play the music data back precisely as the creators or composers originally intended.

■ About this manual

- The illustrations and LCD screens as shown in this manual are for instructional purposes only, and may appear somewhat different from those on your instrument.
- Windows is a registered trademark of Microsoft® Corporation in the United States and other countries.
- Apple, iTunes, Mac, Macintosh, iPhone, iPad, iPod touch and Lightning are trademarks of Apple Inc., registered in the U.S. and other countries.
- IOS is a trademark or registered trademark of Cisco in the U.S. and other countries and is used under license.
- Electone and STAGEA are the trademarks of Yamaha Corporation.
- The company names and product names in this manual are the trademarks or registered trademarks of their respective companies.
- The panel illustrations and LCD screens shown in this owner’s manual are taken from the ELS-02C, Version 2.1x.
- The pan flute and sitar, shown in the displays of the ELS-02/ELS-02C, are on display at the Hamamatsu Museum of Musical Instruments.
- For an ELS-01 series instrument to which a STAGEA Vitalize unit has been installed, the explanations in this owner's manual may differ on certain points (such as there not being a USB Dock installed).

The STAGEA Vitalize unit may not be available depending on your particular locale.

Congratulations!

You are the proud owner of a fine electronic organ, the Electone STAGEA ELS-02/ELS-02C. The Yamaha Electone combines the most advanced tone generation technology with state-of-the-art digital electronics and features to give you stunning sound quality with maximum musical versatility. In order to make the most of your Electone and its extensive performance potential, we urge you to read the manual thoroughly while trying out the various features described. Keep the manual in a safe place for later reference.

About model names

In this manual, the ELS-02 and ELS-02C are referred to as “ELS-02 series” while the previous models are referred to as “ELS-01 series.”

About the Manuals

This instrument has the following documents and instructional materials.

Included Documents



Owner's Manual (this book)

Provides overall explanations of the functions of this instrument.



MIDI Reference

Contains MIDI related information such as MIDI Data Format and the MIDI Implementation Chart.



iPhone/iPad Connection Manual

Explains how to connect this instrument to the iPhone/iPad.

To obtain these manuals, access the Yamaha Downloads. Select your country, enter “ELS-02” to the Model Name box, then click [SEARCH].

Yamaha Downloads

<http://download.yamaha.com/>

Accessories

- Bench
- Owner's Manual
- Online Member Product Registration*

* The PRODUCT ID on the sheet is needed to fill out the User Registration form.

The model number, serial number, power requirements, etc., may be found on or near the name plate, which is at the bottom of the unit. You should note this serial number in the space provided below and retain this manual as a permanent record of your purchase to aid identification in the event of theft.

Model No.

Serial No.

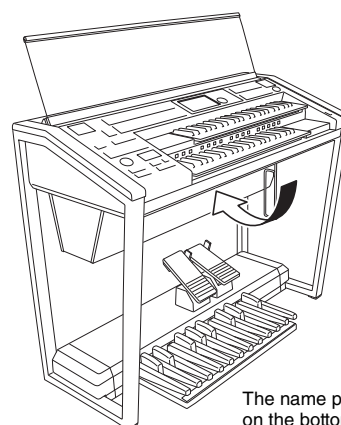

The name plate is located on the bottom of the unit.

(bottom_en_01)

Main Features

A wide variety of Voices including Super Articulation Voices

pages 34 and 39

- The ELS-02 series features a wide variety of special Super Articulation Voices, which realistically recreate characteristic instrument sounds, such as the sound of finger slides on guitar and the breath noises of saxophone or other wind instruments, as well as many of the performance techniques such as legato, vibrato and glissando necessary for wind instruments.
- The ELS-02 series features a piano Voice created with samples of the Yamaha CFX flagship concert grand piano, as well as high-quality Voices of strings, orchestra percussion, and ethnic instruments of the world — lending amazing dynamic realism to your Electone performance.
- The ELS-02C adds to all of that 94 VA (Virtual Acoustic) Voices and a virtually limitless variety of Organ Flute Voices. The authentic touch response keyboard lets you play these Voices with all the expressiveness and control of an actual acoustic instrument.

Sophisticated “Registration Menu” which can be called up any time during your performance

page 19

The five Registration Menu buttons on the front panel feature preset Registrations, allowing you to instantly set up the Electone for playing your favorite type of music. Moreover, the ELS-02C contains an additional 60 Registrations that utilize the expressive Custom Keyboard, VA Voices and Organ Flute Voices. The Registrations in the Registration Menu are divided into basic music categories for ease of selection. Moreover, you can edit any of the Registrations and customize them to fit your own performance needs.

Dynamic, Contemporary Rhythms and Auto Accompaniment

page 56

The exceptionally wide selection of various rhythms lets you choose exactly the rhythm you need in your performance. Each rhythm contains 15 variations (sections) — such as Main, Fill In, Intro, Ending, and Break — that you can easily switch while you play, to make your performance even more dynamic and professional. Each rhythm has its own matching accompaniment divided into five instrument parts, providing basic backing as well as embellishments.

Convenient Edit Functions

pages 50, 81, 95, and 138

- The Voice Link function lets you collect your favorite Voices to a single display and call them up any time during your performance.
- The Registration Memory function lets you memorize your favorite settings for easy recall whenever they're needed. Up to 80 Registrations (5 Banks of 16 Registrations each) can be stored.
- The Voice Edit function lets you create up to 80 original Voices as User Voices. From a wide variety of more than 300 Effect Types divided into 16 categories, two Effect Types can be assigned to each Voice Section, giving you even more tools to enhance, transform and customize the Voices.
- The Keyboard Percussion feature allows for flexible and detailed editing, letting you assign your desired percussion sound to each note of the keyboard to create your own original drum kit.
- Comprehensive data compatibility lets you use data created on ELS-01 series instruments with the new ELS-02 series. For ease of use, the ELS-02 series features the same familiar operations as that of the ELS-01 series, since the layout of the panel buttons is identical.

This large LCD display not only lets you clearly see a wide selection of settings and parameters at almost any angle, it also serves as a touch control panel — letting you intuitively make selections and adjust settings simply by touching the screen! Once you touch a setting, you can even adjust it in finer detail if necessary with the Data Control dial.

You can record your performances as audio data (.WAV) to a USB flash drive. Since the data is saved in stereo WAV format of normal CD quality resolution (44.1kHz/16bit), it can be transmitted to and played on portable music players by using a computer, allowing you to share your recordings with your friends, and make your own CDs to enjoy as well.

The ELS-02/ELS-02C is compatible with the following formats.



GM (General MIDI) is one of the most common Voice allocation formats. GM System Level 2 is a standard specification that enhances the original GM and improves Song data compatibility. It provides for increased polyphony, greater Voice selection, expanded Voice parameters, and integrated effect processing.



XG is a major enhancement of the GM System Level 1 format, and was developed by Yamaha specifically to provide more Voices and variations, as well as greater expressive control over Voices and effects, and to ensure compatibility of data well into the future.



The Yamaha XF format enhances the SMF (Standard MIDI File) standard with greater functionality and open-ended expandability for the future. This instrument is capable of displaying lyrics when an XF file containing lyric data is played.



GS was developed by the Roland Corporation. In the same way as Yamaha XG, GS is a major enhancement of the GM specifically to provide more Voices and Drum kits and their variations, as well as greater expressive control over Voices and effects.



The Style File Format combines all of Yamaha's auto accompaniment know-how into a single unified format.



“AEM” is the trademark of Yamaha's leading-edge tone generation technology. For information on AEM, refer to the Reference Manual on the website.

- The bitmap fonts used in this instrument have been provided by and are the property of Ricoh Co., Ltd.

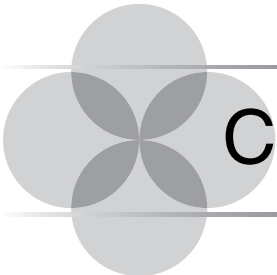

Contents

PRECAUTIONS	2
About the Manuals	5
Accessories	5
Main Features	6

Panel Layout 10

Front Panel	10
LCD Display/Display Select	12
Overview	12

1. Quick Introductory Guide 13

Getting Started	13
Using the LCD Display	14
Changing the display page	14
Using the display buttons	14
Adjusting parameter values by using the display sliders ..	15
LCD Display Settings	16
Selecting the display language	16
Muting the touch panel sound	16
Adjusting the display brightness	17
Voice Display	17
Registration Menu	19
Selecting Registrations from the Registration Menu	19
Registration Menu list	20
Confirming the Electone Version	23
Factory Set (Initializing the Electone)	23

2. Voices 24

Voices for Each Keyboard	24
Selecting Voices with the Voice Buttons	25
Registering a Voice to Voice Link	25
Changing the Voice volume	26
Selecting Voices from the User Buttons	28
Voice List	29
Tone Generators of the ELS-02 Series	39
AWM Tone Generator	39
VA Voices	39

3. Organ Flutes (ELS-02C) 40

4. Voice Controls and Effects 42

Settings Selected from the Voice Condition Display	43
Selecting from the Panel	46
Reverb	46
Sustain	48
Brilliance	48
Rotary Speaker	49
Using Voice Link	50
Registering a Voice with the settings on the Voice Condition display to Voice Link	50
Selecting a Voice registered to Voice Link	50
Editing the Voice registered to Voice Link	51
Releasing the current Voice settings from Voice Link	51
Registering a Voice to Voice Link with a different Voice name	52
Deleting a Voice from Voice Link	52
Effect List	54

5. Rhythm/Keyboard Percussion 56

Selecting Rhythms with the Rhythm Buttons	56
Selecting a rhythm	56
Operating the rhythm from the panel	57
Changing the rhythm volume	59
Adjusting the tempo	59
Changing the rhythm reverb	60
Selecting Rhythms from the User Buttons	60
Rhythm List	61
Accompaniment	65
Automatic Accompaniment – Auto Bass Chord (A.B.C.)	66
Melody On Chord (M.O.C.)	67
Keyboard Percussion	68
Using the Preset Keyboard Percussion	68
Preset Keyboard Percussion List	70
Creating a User Keyboard Percussion Kit	81
Copying the Keyboard Percussion settings	83
Detailed settings for each percussion instrument	83
Kit Assign list	85

6. Registration Memory 95

Storing Registrations	95
Storing Registrations to Another Bank	96
Selecting Registrations	96
Saving the Registration Data to USB Flash Drive	97
Initializing Registration Memory	98
Registration Shift	99
Setting the Registration Shift mode in the Regist Shift display	99
Confirming the Registration Shift setting in the Voice Display	101
Unifying Values/Settings of a Specific Parameter	102
Copying Registrations	104

7. Music Data Recorder (MDR) 106

Calling Up the MDR Display	106
Using the MDR Display	106
Song icons	108
Precautions when using the [USB TO DEVICE] terminal ..	110
Using USB flash drives	110
Formatting a USB Flash Drive	111
Selecting a Song	112
Searching for a Song	112
Recording	114
Recording your performance	114
Re-recording (Retry)	114
Recording specified parts only	115
Punch-in recording	116
Changing the Song Name	116
Saving Registrations and Other Data to a Unit	118
Creating two or more Registration Units in a Song	118
Overwriting Registration data to a Unit	118
Changing the order of the Registration Units	119
Recalling Recorded Registrations	120
Playing Back a Song	121
Playing back the selected part(s)	122
Fast forward, Rewind and Pause	122
Changing the tempo	123
Repeat playback	123

Displaying the Score.....	124
Changing the score contents and settings	125
Other Functions (Tools)	126
Song copy	126
Song delete	128
Converting to XG	129
Converting ELS format to EL	130
Converting EL format to ELS	131
Checking the remaining memory	131

8. Audio 132

Recording Your Performance as Audio	132
Playing Back Audio Files	134
Rewind, Fast Forward and Pause	135
Changing the Volume, Tempo and Pitch	136
Repeat playback	136
Other Functions (Tools)	137
Creating a New Folder/Deleting the File/ Changing the File Name.....	137
Audio file copy.....	137

9. Voice Edit 138

Voice Structure	138
AWM Voice structure.....	138
VA Voice structure.....	138
Editing a Voice.....	139
Selecting a Voice for editing	139
Editing an AWM Voice.....	140
Editing a VA Voice (ELS-02C only).....	143
Saving the Edited Voice.....	144
Quitting Voice Edit	145
Recalling an Edited Voice.....	145

10. Rhythm Program 146

Outline of the Rhythm Programming Operation.....	146
Rhythm Pattern Program.....	146
Entering the Rhythm Pattern Program	146
Basic settings for the rhythm pattern	148
Entering percussion sounds to a rhythm pattern — Step Write	151
Editing entered percussion notes	152
Entering percussion sounds to a rhythm pattern — Real Time Write	155
Creating backing patterns (Rhythmic Chord function)	156
Changing the Voices for Accompaniment parts	158
Adjusting volume and panning	159
Effect settings.....	159
Detailed settings for each percussion instrument.....	160
Saving rhythm patterns	161
Quitting the Rhythm Pattern Program.....	162
Recalling User rhythm patterns.....	163
Selecting rhythms from a USB flash drive.....	163
Percussion Kit list	164
Rhythm Sequence Program.....	172
Selecting a sequence.....	172
Programming a sequence.....	173
Auditioning a sequence	173
Editing an existing Rhythm Sequence	174
Programming a Registration Sequence	174
Editing an existing Registration Sequence	175
Quitting the Rhythm Sequence Program.....	176
Playing Rhythm Sequences	176
Playing all sequences in order	176
Copying a Rhythm Sequence	177

Saving Rhythm Pattern and Rhythm Sequence Data to a USB Flash Drive	177
--	-----

11. Footswitches, Knee Lever and Expression Pedals 178

Footswitches.....	178
Controlling the Rhythm.....	179
Controlling Glide	179
Controlling Rotary Speaker.....	180
Calling up another page of the music score.....	180
Controlling the Super Articulation Voices	180
Knee Lever	180
Controlling Sustain	180
Controlling Melody On Chord	181
Controlling Lead Slide.....	182
Controlling the Solo function	182
Expression Pedals.....	182
Controlling Pitch Bend	183
Controlling the Rhythm Tempo	183

12. Transpose and Pitch Controls 184

13. Connections 185

Accessory Jacks and Controls.....	185
Connection Examples – External Devices.....	187
Using headphones.....	187
Playing the sounds of the Electone through an external audio system	187
Recording the sounds of the Electone to an external recorder.....	188
Outputting the sound of an external device through the built-in speakers of the Electone.....	189
Connecting a microphone or guitar	189
Controlling external MIDI devices from the Electone.....	190
Controlling the Electone from an external device	190
Connection with Computer.....	191
Connecting to a Computer ([USB TO HOST] terminal)	191
Connecting to a Computer (MIDI terminal).....	191
MIDI Control	192
Connecting to an iPhone/iPad.....	193
Wireless LAN settings.....	193
Wireless LAN Detailed Settings	198
Initialize the wireless LAN settings.....	200
Glossary of Terms	200

14. Appendix 201

Troubleshooting.....	201
Specifications	204
Index	206

Panel Layout

Front Panel

The panel illustrations shown are taken from the ELS-02C.

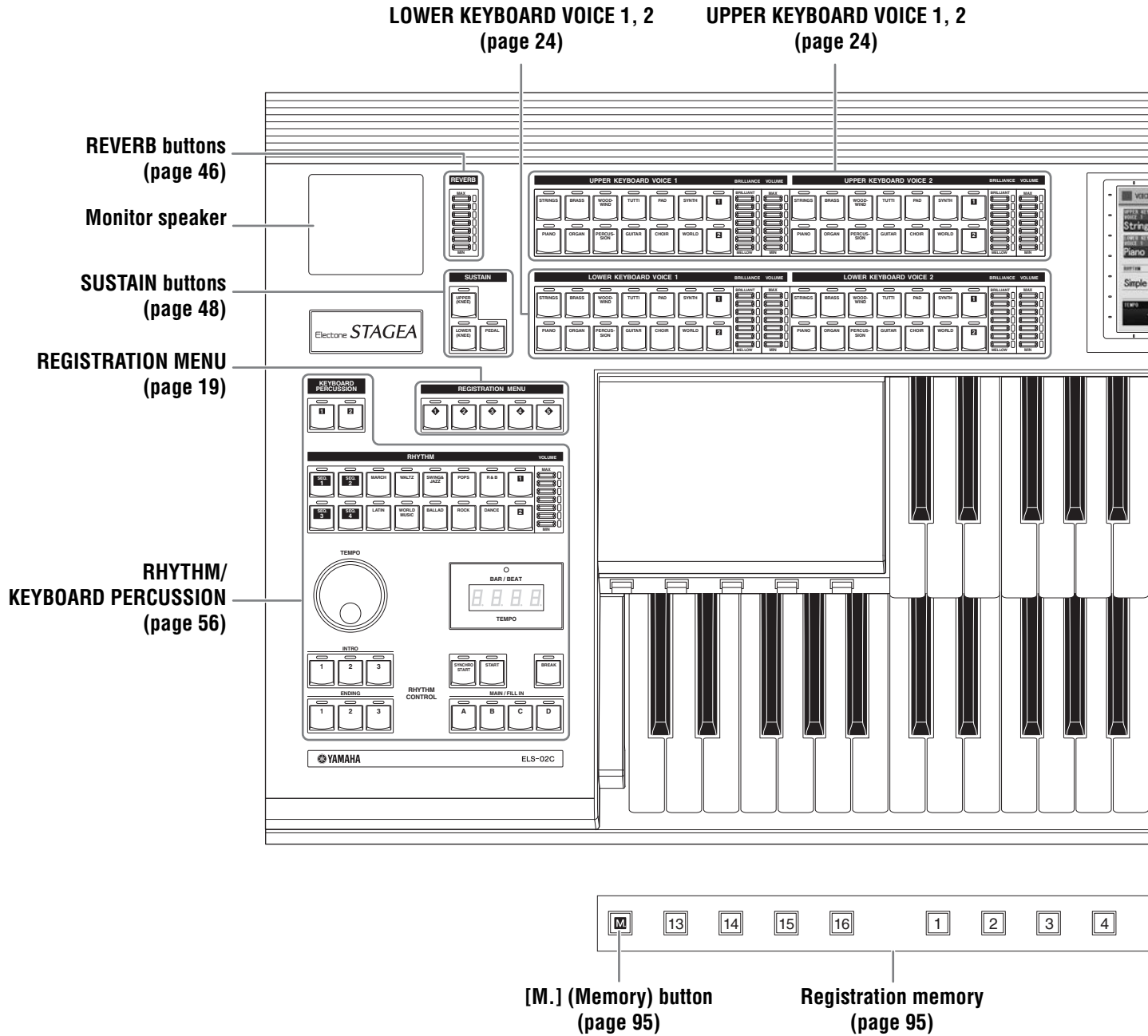

LCD display/
DISPLAY SELECT
(page 12)

PEDAL VOICE 1, 2
(page 25)

LEAD VOICE 1, 2
(page 24)

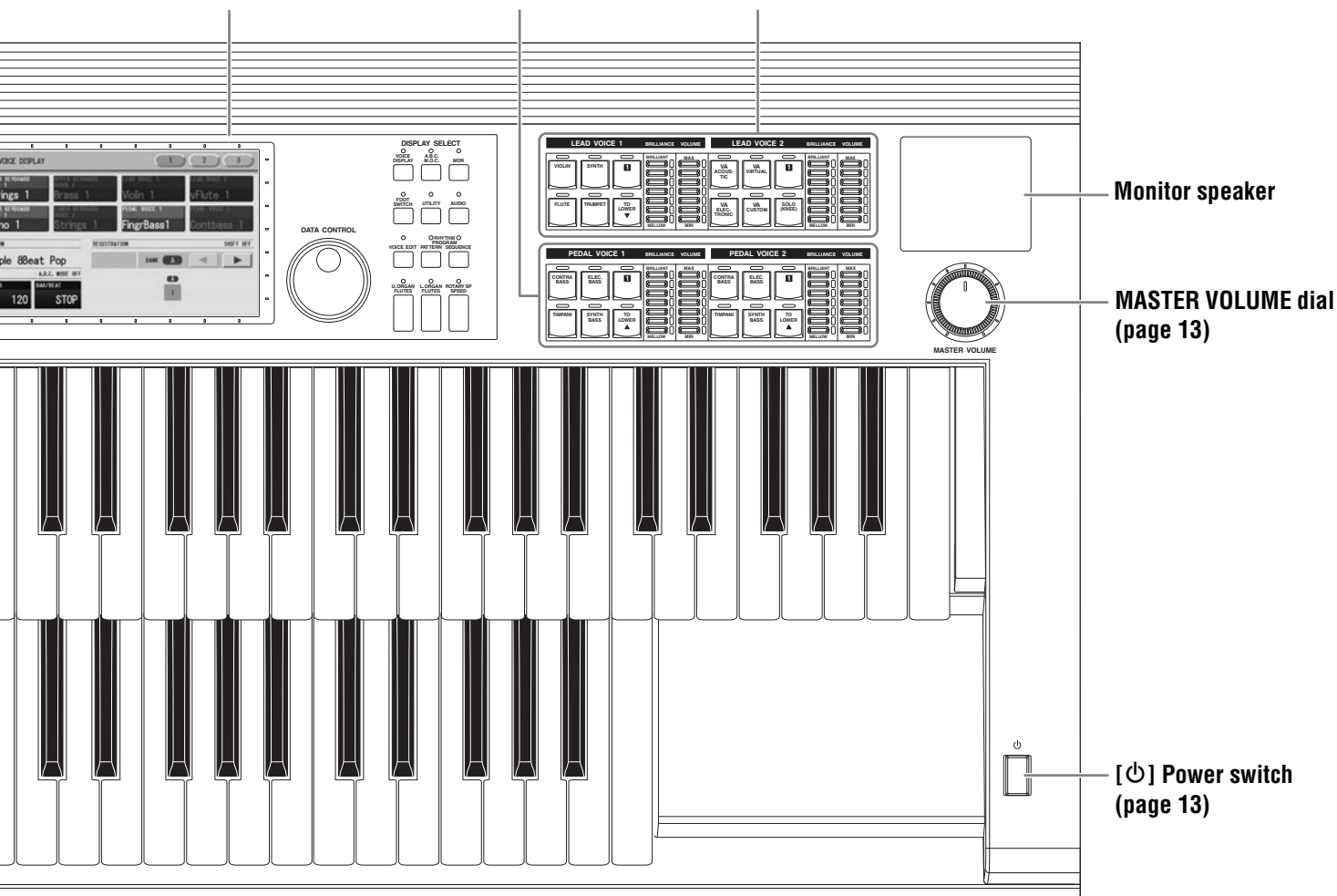

Monitor speaker

MASTER VOLUME dial
(page 13)

[⏻] Power switch
(page 13)

[D.] (Disable) button
(page 96)

LCD Display/Display Select

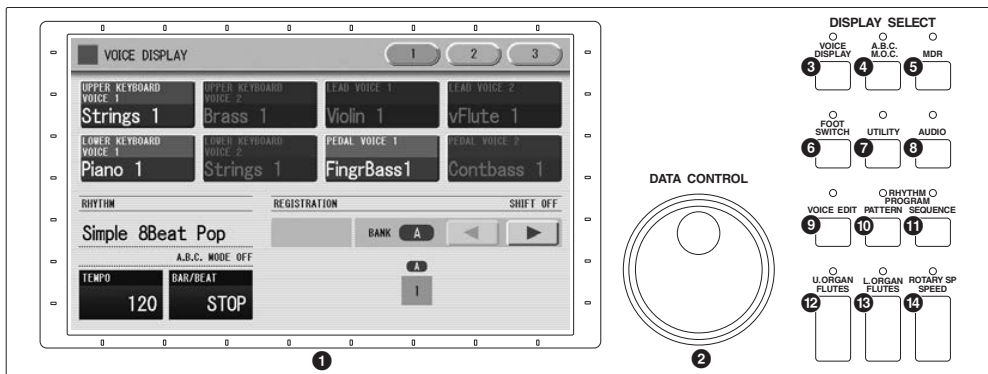

- | | |
|--|---|
| ① LCD display (touch panel)..... page 14 | ⑨ [VOICE EDIT] button page 138 |
| ② DATA CONTROL dial..... page 15 | ⑩ [PATTERN] button page 146 |
| ③ [VOICE DISPLAY] button..... page 17 | ⑪ [SEQUENCE] button page 172 |
| ④ [A.B.C./M.O.C.] button..... pages 66, 67 | ⑫ [U. ORGAN FLUTES] button.....page 40 |
| ⑤ [MDR] button.....page 106 | ⑬ [L. ORGAN FLUTES] button.....page 40 |
| ⑥ [FOOT SWITCH] buttonpages 99, 178 | ⑭ [ROTARY SP SPEED] buttonpage 49 |
| ⑦ [UTILITY] button pages 16, 182, 184, 192 | |
| ⑧ [AUDIO] button.....page 132 | |

Overview

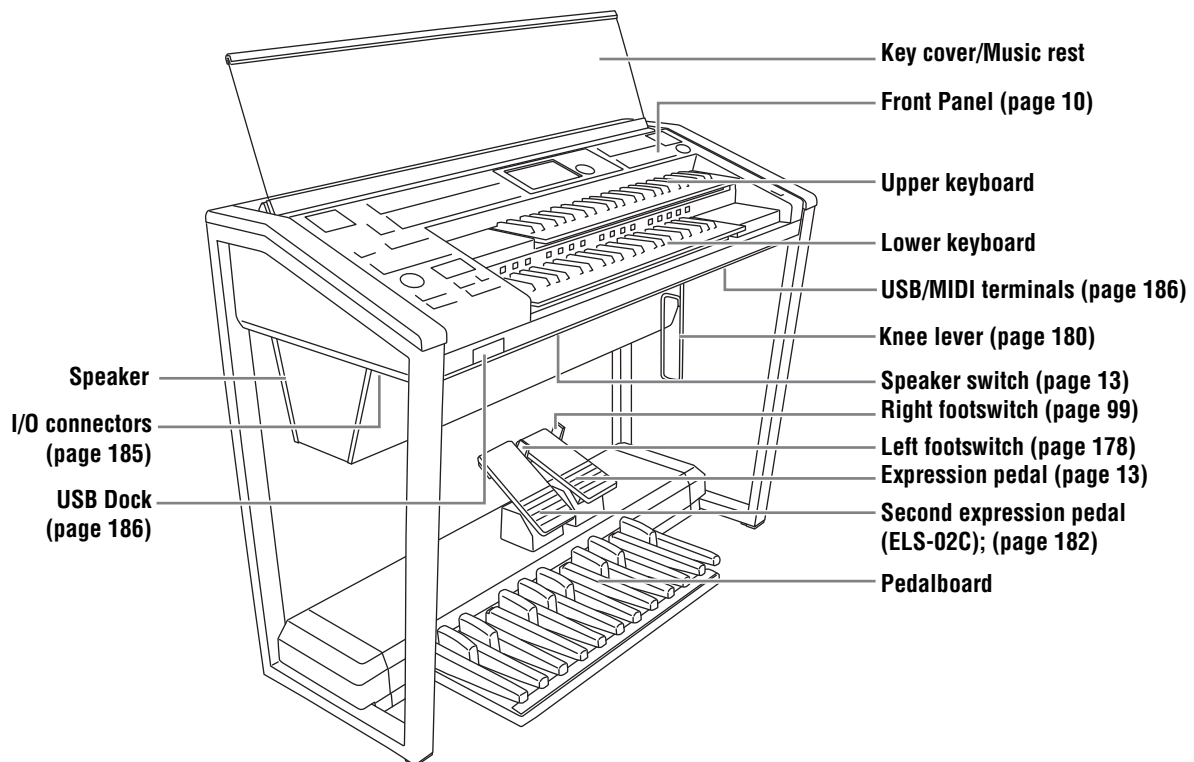

NOTE

An ELS-01 series instrument with an installed STAGEA Vitalize unit has only two [USB TO DEVICE] terminals installed on the right side. The USB Dock is not installed.

1 Quick Introductory Guide

Whether you are an advanced performer or have never touched an electronic keyboard in your life, we recommend that you take the time to go through this basic section. It shows you in the simplest possible manner how to start playing your Electone.

Getting Started

- 1 Plug the power cord into an appropriate electrical outlet.

CAUTION

Only use the voltage specified as correct for the Electone. The required voltage is printed on the name plate of the Electone. Yamaha products are manufactured specifically for the supply voltage in the area where they are to be sold. If you intend to use the instrument in another location, or if any doubt exists about the supply voltage, please consult with a qualified technician.

- 2 Make sure that the speaker switch (page 12) is set to on.

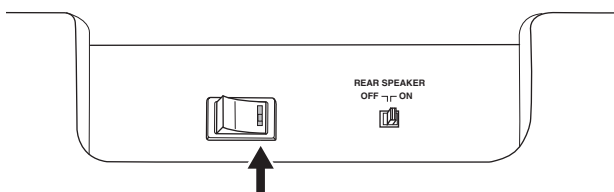

If you are using the ELS-02C, also set the REAR SPEAKER switch to on (not available on the ELS-02).

NOTE

- When using the rear speaker, place the Electone against a wall, allowing about 20 cm from the wall for optimum sound.
- You do not need to switch the power of the speaker on/off whenever you use the instrument. If you want, you can always keep it on and turn the power on and off by pressing the main power switch of the instrument.
- For an ELS-01/ELS-01U instrument with an installed STAGEA Vitalize unit, the SPEAKER switch cannot be used.

- 3 Press the [⏻] Power switch located on the right of the keyboard to turn the power on.

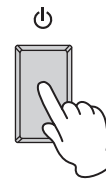

To turn off the Electone, press the [⏻] Power switch again.

CAUTION

Even when the power switch is turned off, electricity is still flowing to the instrument at the minimum level. When you are not using the instrument for a long time, make sure you unplug the power cable from the wall AC outlet.

- 4 Set the MASTER VOLUME control.

The MASTER VOLUME control is an overall control that affects the volume of the entire instrument.

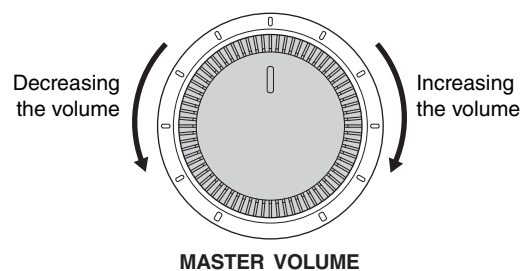

- 5 Press the Expression pedal down with your foot.

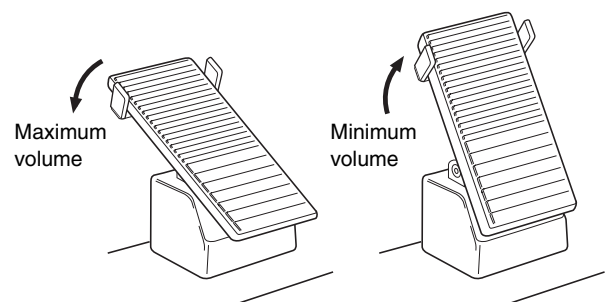

Using the LCD Display

This instrument features a special touch panel that allows you to change the parameters by simply touching the ‘virtual’ buttons or sliders on the display. (Please note that two or more parameters cannot be operated simultaneously.)

You can also use the Data Control dial (page 12) to make fine changes to the parameter value shown in the display.

NOTE

When cleaning the display, use a soft, dry cloth.

NOTICE

Do not use any sharp or hard tools to operate the touch panel. Doing so may damage the display.

Changing the display page

There are some oval-shaped numbered buttons at the top right of the display. Pressing these buttons changes the ‘page’ of the display. The button of the selected page is highlighted in orange.

Page 1



Page 2

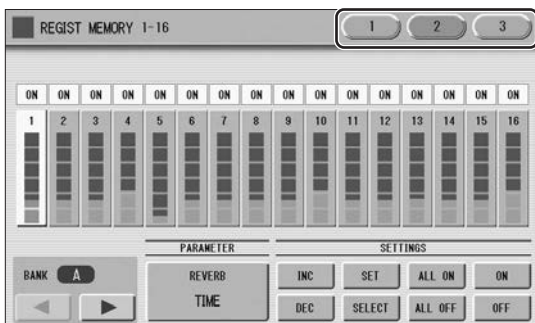

Press this button to select Page 1

Press this button to select Page 2

Press this button to select Page 3

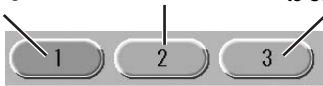

Using the display buttons

There are three types of display buttons: those that select a function, those that switch a function on/off, and those that open a list or menu of parameters. To select the desired function, simply press the button in the display directly.

To switch a function on/off or open a parameter list, see the instructions below.

To switch the function on or off:

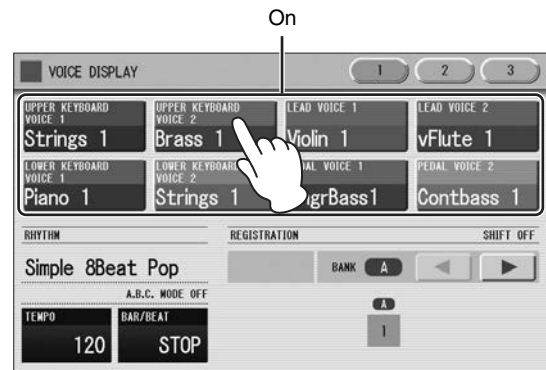

Off, or muted (button is grayed out)

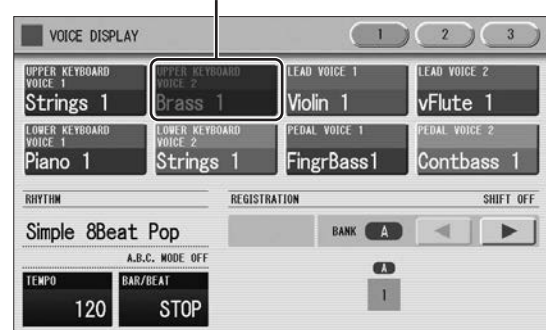

You can independently mute each Voice section in the Voice Display, each accompaniment part in Rhythm Menu display, and each Element in the Voice Edit display.

To open the parameter list:

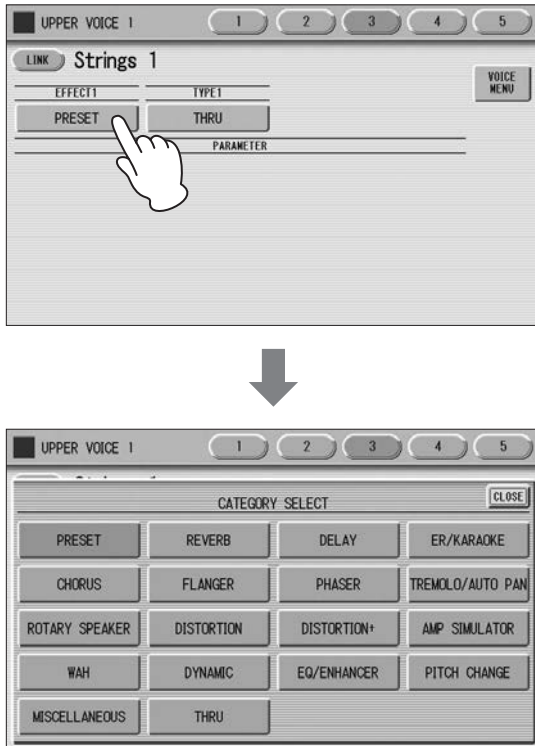

When you press a button, a parameter list will appear in which you can select the desired parameter. When you select items in the display, the list closes automatically. You can also close the list by pressing the [CLOSE] button at the top right of the list.

To change the parameter value:

To make coarse changes to the value, use the [▲]/[▼] buttons. For fine adjustment, use the Data Control dial.

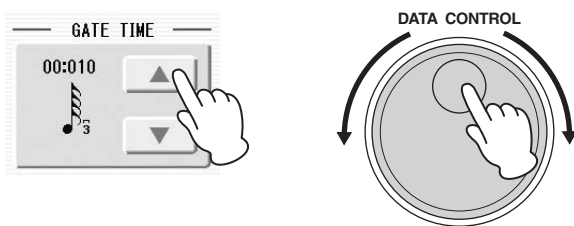

Adjusting parameter values by using the display sliders

You can adjust some parameters such as Volume, Reverb, Pan and so on, by using the 'virtual' sliders in the display. There are two ways to move the slider in the display: touching it directly, and using the Data Control dial. We suggest that you touch the display slider when making coarse adjustments and use the Data Control dial for fine adjustment.

Touching the display slider directly:

To change a display slider value, press the desired point in the slider. The slider moves to the point that is pressed. You can also change the parameter value by sliding your finger up or down while holding down on the display slider.

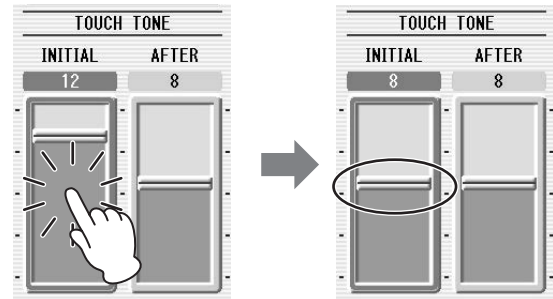

Slider will move to the point you touch

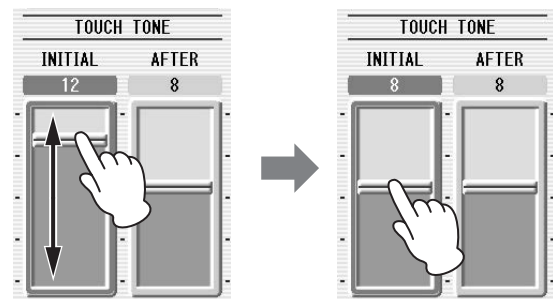

Slider will follow your finger

Using the Data Control dial:

Touch on/above the slider in the display to enable the parameter and set a rough value, then turn the Data Control dial.

Touch here to enable the parameter

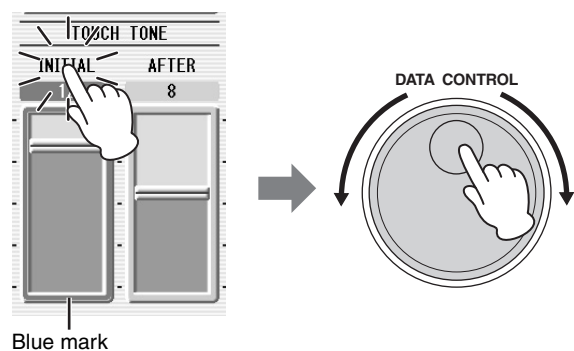

Blue mark

To control Pan, you can move the horizontal slider in the same way as vertical sliders.

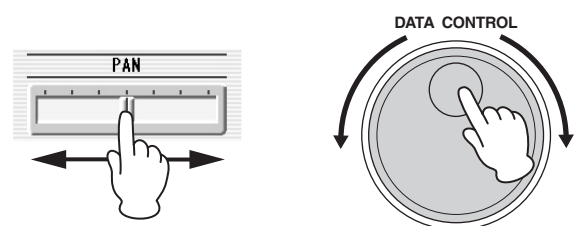

LCD Display Settings

Here you can change the display settings: displayed language (English or Japanese), touch panel sound, and display brightness.

Selecting the display language

The LCD display can be shown in two languages, English and Japanese. The default setting is English.

- 1 Press the [UTILITY] button to call up the GLOBAL Page of the Utility display.

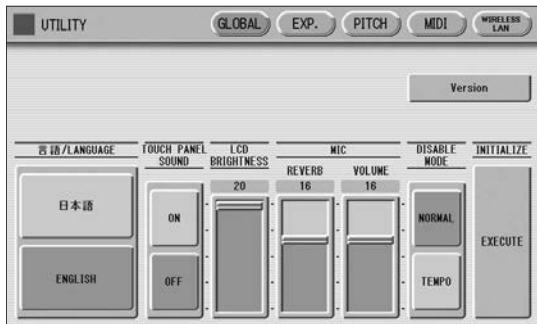
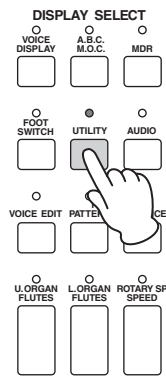

NOTE

The settings in the Utility display are automatically saved when another display is called up.

- 2 Press the desired button, 日本語 (Japanese) or [English].

LANGUAGE

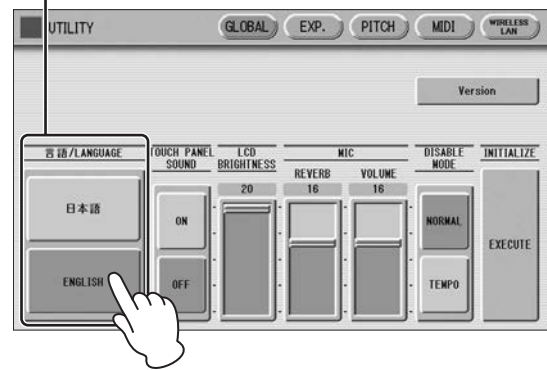

Muting the touch panel sound

By default, the Electone is set with the touch panel sound turned on, giving you audio feedback when you press a button or control. If you want to mute the touch panel sound, follow the procedure below.

- 1 Press the [UTILITY] button to call up GLOBAL Page of the Utility display.
- 2 Press the [OFF] button of the TOUCH PANEL SOUND to mute the sound.

TOUCH PANEL SOUND

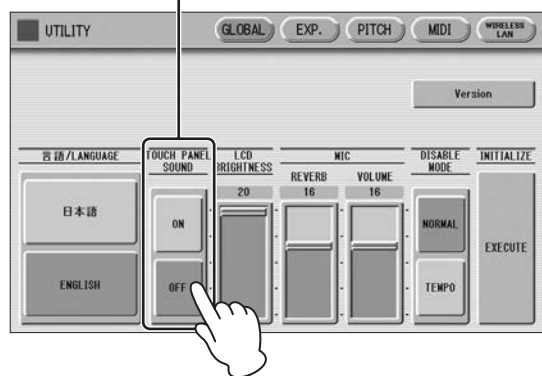

To turn the sound on again, select [ON] in step 2.

Adjusting the display brightness

You can adjust the display brightness to a comfortable, easy-to-read level.

- 1 Press the [UTILITY] button to call up the GLOBAL Page of the Utility display.
- 2 Move the LCD BRIGHTNESS slider by touching it directly or using the Data Control dial.

Higher settings make the display brighter and lower settings make it darker.

Reference page

- Touching the display slider directly (page 15)

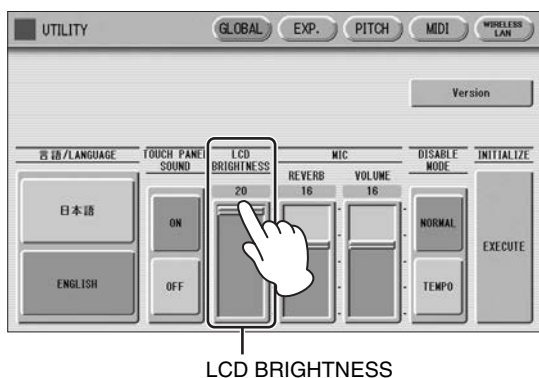

Voice Display

You can visually confirm the currently assigned Voices to each keyboard, currently selected rhythm, Registration Shift, and so on, in the Voice Display.

How to call up the Voice Display:

The Voice Display always appears when the Electone is turned on. To call up the Voice Display from any other display, press the [VOICE DISPLAY] button.

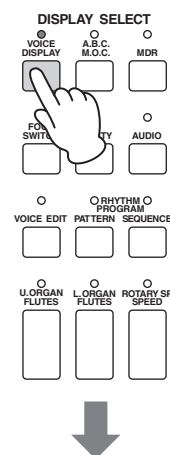

The Voice Display consists of three different pages that can be switched by pressing the [1], [2], or [3] button at the top right of the display.

Voice Display [Page 1]

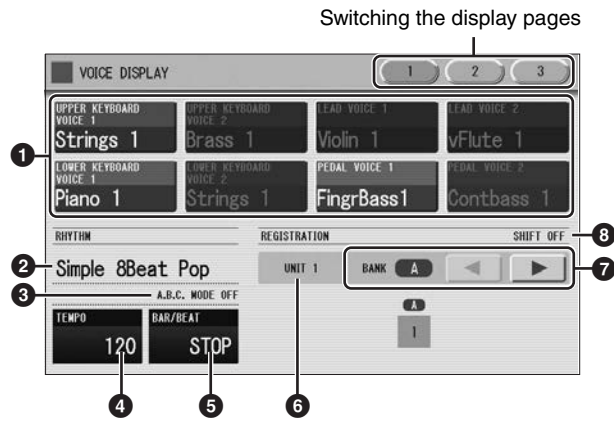

1 Voice Sections

Shows the Voices currently assigned to each Voice section. You can also mute a specific Voice section by pressing its button (the button is grayed-out).

Reference page

- Selecting a Voice (page 25)

2 RHYTHM

Shows the currently selected rhythm.

Reference page

- Selecting a rhythm (page 56)

3 A.B.C. MODE

Shows the Auto Bass Chord mode.

Reference page

- Auto Bass Chord (page 66)

4 TEMPO

Shows the current rhythm tempo.

Reference page

- Adjusting the tempo (page 59)

5 BAR/BEAT

Shows the bar/beat when the rhythm is playing.

6 Registration Unit

Shows the currently selected Registration Unit.

Reference pages

- About Banks and Units (page 98)
- Creating two or more Registration Units in a Song (page 118)

7 Registration Bank Selection

For selecting the desired Registration Bank. You can select the Banks from A (at top) to an empty Bank next to the last Bank containing data. When Banks A and B contain Registration data, for example, you can select Banks A, B, and C (which is empty). The on/off indication of Bank (A – E) shows whether the selected Bank contains data or not.

Reference pages

- Registration Memory and Bank (page 95)
- Storing Registrations to Another Bank (page 96)

8 Registration Shift

Shows the current position of the Registration Shift.

Reference page

- Registration Shift (page 99)

Voice Display [Page 2]

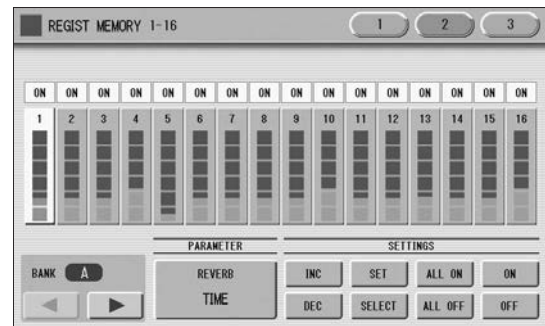

You can confirm the parameter values (for example, Reverb, Volume, Pan) for each Registration Memory simultaneously. Moreover, you can unify the values of a specific parameter used in various Registration Memories at one time. See page 102 for the details.

Voice Display [Page 3]

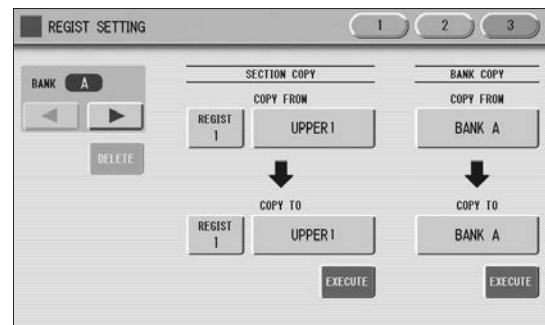

The Registrations stored to the Registration number can be copied to another Registration number for each individual section. Also Banks can be copied or deleted. For details, see page 105.

Reference page

- Registration Memory (page 95)

Registration Menu

A “Registration” consists of panel settings including the selected Upper Keyboard Voices, Lower Keyboard Voices, Pedal Voices, rhythm and so on. Each Registration Menu button (1 – 5) includes each different music styles of the Registrations. Use each button properly in accordance with the music styles you want to perform.

NOTE

Additional basic Registrations are preset on the Registration Memory locations from 1 to 16. See page 95 for details.

Selecting Registrations from the Registration Menu

1 Press one of the REGISTRATION MENU buttons.

Each button has different Registrations for different music genres. For example, if you want to play Jazz, press the [4] button. For details on the Registration Menu, see page 20.

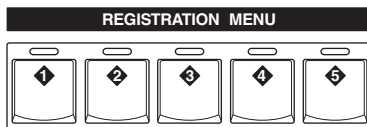

1	01 Kids / 02 Simple
2	01, 02 Pops & Rock
3	01, 02 Dance & Ballad
4	01, 02 Jazz & Latin
5	01, 02 Symphony & World

2 Select the desired Registration by pressing the appropriate button on the display.

Each of the REGISTRATION MENU buttons features two tabs on the display: [01] and [02] which calls up two pages alternatively. [01] features the same Registration Menu as that of the ELS-01 series. On each of [01] page and [02] page, press any of the number buttons [1] – [5] then select the desired Registration.

Change the display pages here.

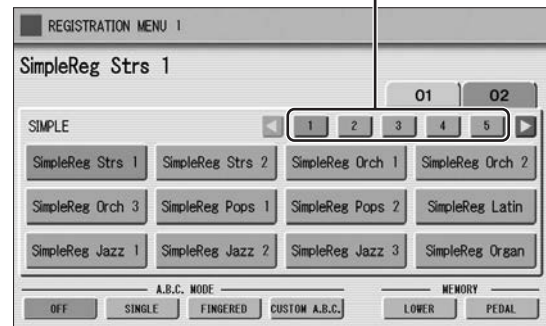

The color of the selected Registration name changes to orange, indicating that it has been selected, and the Auto Bass Chord mode is shown at the bottom of the display.

Reference page

- Auto Bass Chord (page 66)

3 Play your favorite Song with the selected Registration.

Registration Menu list

REGISTRATION MENU 01

Page	REGISTRATION MENU 1 01 KIDS	REGISTRATION MENU 2 01 POPS & ROCK	REGISTRATION MENU 3 01 DANCE & BALLAD	REGISTRATION MENU 4 01 JAZZ & LATIN	REGISTRATION MENU 5 01 SYMPHONY & WORLD	
1	Simple 8Beat 1	Dynamic 8Beat	Organ Ballad	Blow On Sax	Fanfare	
	Simple 8Beat 2	NY Ballad	Dramatic Ballad	Sax Ensemble	String Orchestra	
	Light Step	British Pop	Love Ballad	Moonlight	Romantic Violin	
	Sunny Pop	8Beat Modern	Smooth Lead	Big Band	Baroque	
	Kids March 1	Rock Band	Pop Ballad	Clarinet Swing	Flute & Harp	
	Kids March 2	Detroit Pop	Guitar Ballad	Jazz Combo	Serenade	
	Kids March 3	Techno Pop	Acoustic Ballad	Medium Jazz	Fast March	
	Synth Rock	Sheriff Reggae	Healing Guitar	Organ Session	Wild West	
	SymphonicMarch 1	Rock & Roll	Chillout	Guitar Combo	Vienna Waltz	
	SymphonicMarch 2	Power Rock	Sweetheart 1	Tender Ballad	Polka	
	Bluegrass	60s Guitar Rock	Sweetheart 2	Jazz Waltz	Chanson Club	
	Sea Carnival	Unplugged	Slow & Easy	Five-Four	Theatre Organ	
2	Basic Waltz	Motor City	Euro Trance	Big Band Samba	Flamenco	
	Brass Ensemble	Lovely Shuffle	6/8 Trance	Mambo Brass	Pop Flamenco	
	Pure Waltz	Gospel Shuffle	Cool Hip Hop	Mambo Tenor	Mexican Dance	
	Rococo Ensemble	Joyful Gospel	Latin House	Montuno	Mariachi	
	Pop Cha Cha	Frankly Soul	Dance Beat	Bossa Nova	Celtic Dance	
	Comical Rumba	Soul	Euro Dance Pop	Pop Bossa	Folk Step	
	Comical Samba	Gospel	UK Pop	Sweet Rumba	Italiano	
	Toy Orchestra	6/8 Soul	Jive	Beguine	Musette	
	Charleston	Hit Pop	Disco Queen	Cha Cha Cha	Country	
	Winter Swing	New Country	Disco Soul	Mellow Groove	Hawaiian	
	Snow Waltz 1	Eternal Pop	Pop Disco	Modern R&B	Chinese Nocturne	
	Snow Waltz 2	Ground Beat	Hot Disco	Dixieland Jazz	Japanese Sound	
	3	Alpine Polka *A	Bounce Pop *A	Ibiza *A	Jungle Drum *A	OrchestraMarch*A
		Alpine Polka *B	Bounce Pop *B	Ibiza *B	Jungle Drum *B	OrchestraMarch*B
Alpine Polka *C		Bounce Pop *C	Ibiza *C	Jungle Drum *C	OrchestraMarch*C	
Alpine Polka *D		Bounce Pop *D	Ibiza *D	Jungle Drum *D	OrchestraMarch*D	
Dream Ballad *A		Blues Jam *A	Power House *A	Jazz Club *A	Pasodoble *A	
Dream Ballad *B		Blues Jam *B	Power House *B	Jazz Club *B	Pasodoble *B	
Dream Ballad *C		Blues Jam *C	Power House *C	Jazz Club *C	Pasodoble *C	
Dream Ballad *D		Blues Jam *D	Power House *D	Jazz Club *D	Pasodoble *D	
Pops Orchestra*A		EvergreenWaltz*A	Dance Latino *A	Afro Session *A	Tango *A	
Pops Orchestra*B		EvergreenWaltz*B	Dance Latino *B	Afro Session *B	Tango *B	
Pops Orchestra*C		EvergreenWaltz*C	Dance Latino *C	Afro Session *C	Tango *C	
Pops Orchestra*D		EvergreenWaltz*D	Dance Latino *D	Afro Session *D	Tango *D	
4	Kids On Stage *A	16Beat Pop *A	Twilight Disco*A	ChaCha Grandee*A	Show Time *A	
	Kids On Stage *B	16Beat Pop *B	Twilight Disco*B	ChaCha Grandee*B	Show Time *B	
	Kids On Stage *C	16Beat Pop *C	Twilight Disco*C	ChaCha Grandee*C	Show Time *C	
	Kids On Stage *D	16Beat Pop *D	Twilight Disco*D	ChaCha Grandee*D	Show Time *D	
	Galaxy March *A	Top Gear Rock *A	Love Song *A	3/4 Fast Jazz *A	Majestic Sound*A	
	Galaxy March *B	Top Gear Rock *B	Love Song *B	3/4 Fast Jazz *B	Majestic Sound*B	
	Galaxy March *C	Top Gear Rock *C	Love Song *C	3/4 Fast Jazz *C	Majestic Sound*C	
	Galaxy March *D	Top Gear Rock *D	Love Song *D	3/4 Fast Jazz *D	Majestic Sound*D	
	SE *A	Southern Pop *A	Movie Ballad *A	Twilight Sax *A	OrchestraSwing*A	
	SE *B	Southern Pop *B	Movie Ballad *B	Twilight Sax *B	OrchestraSwing*B	
	SE *C	Southern Pop *C	Movie Ballad *C	Twilight Sax *C	OrchestraSwing*C	
	SE *D	Southern Pop *D	Movie Ballad *D	Twilight Sax *D	OrchestraSwing*D	
	5 (ELS-02C)	Bright 16Beat *A	Funk *A	Hip Hop Pop *A	Organ Bossa *A	Orchestra 3001*A
		Bright 16Beat *B	Funk *B	Hip Hop Pop *B	Organ Bossa *B	Orchestra 3001*B
Bright 16Beat *C		Funk *C	Hip Hop Pop *C	Organ Bossa *C	Orchestra 3001*C	
Bright 16Beat *D		Funk *D	Hip Hop Pop *D	Organ Bossa *D	Orchestra 3001*D	
Movie Panther *A		WestCoast Rock*A	Fusion Shuffle*A	Afro Cuban *A	Wedding Song *A	
Movie Panther *B		WestCoast Rock*B	Fusion Shuffle*B	Afro Cuban *B	Wedding Song *B	
Movie Panther *C		WestCoast Rock*C	Fusion Shuffle*C	Afro Cuban *C	Wedding Song *C	
Movie Panther *D		WestCoast Rock*D	Fusion Shuffle*D	Afro Cuban *D	Wedding Song *D	
Powerful Swing*A		6/8 Enka *A	Whole Ballad *A	Midnight Jazz *A	Fantasy *A	
Powerful Swing*B		6/8 Enka *B	Whole Ballad *B	Midnight Jazz *B	Fantasy *B	
Powerful Swing*C		6/8 Enka *C	Whole Ballad *C	Midnight Jazz *C	Fantasy *C	
Powerful Swing*D		6/8 Enka *D	Whole Ballad *D	Midnight Jazz *D	Fantasy *D	

REGISTRATION MENU 02

Page	REGISTRATION MENU 1 02 SIMPLE	REGISTRATION MENU 2 02 POPS & ROCK	REGISTRATION MENU 3 02 DANCE & BALLAD	REGISTRATION MENU 4 02 JAZZ & LATIN	REGISTRATION MENU 5 02 SYMPHONY & WORLD
1	SimpleReg Strs 1	70s Easy Pop	R&B Pop Ballad	Big Band Tutti	Orch Full Unit
	SimpleReg Strs 2	BoysGuitarBallad	R&B Soul Ballad	Alto Sax Combo	String Classic
	SimpleReg Orch 1	Soul Pop	R&B Cool Ballad	Jazz Combo Fast	Sweet Pizzicato
	SimpleReg Orch 2	70s Top Duo	Cool AC	Jazz Combo 66	Baroque Symphony
	SimpleReg Orch 3	Daydream Shuffle	Sweet Chart Hits	The Big Band *A	Nostalgic Green
	SimpleReg Pops 1	Oldies Pop	SweetSlowBallad	The Big Band *B	New Year March
	SimpleReg Pops 2	EuroPopFolklore	YourPiano Ballad	GuitarJazzCombo	Wind Orchestra
	SimpleReg Latin	Discotheque Rock	Sweet EP Ballad	The Swing Jazz	BrassBand Parade
	SimpleReg Jazz 1	Slow Hand Ballad	J-Pop EasyBallad	New Orleans Jazz	Choral No.9
	SimpleReg Jazz 2	Sweet AC Ballad	Sweet Sax Ballad	Ragtime Band	Angel Voices
	SimpleReg Jazz 3	70s PrimeTimeTV	Sweet R&B Ballad	Funky Cat Groove	Beat Classic
SimpleReg Organ	Crossover Funk	Lovers R&B	Afro Cuban Jazz	Can Can Pop	
2	BrassBandMarch*A	Joyful Gospel #2	Sentimental Bld	GuitarJazzWaltz	Elegant Waltz
	BrassBandMarch*B	Gospel Groove	Tears Ballad	Sax Jazz Waltz	Chorus Waltz
	Orchestra March	Worship Shuffle	Glory Ballad	Swing Steps	Love Waltz
	6/8MarchingBand	Worship 16beat	Unplugged Ballad	Swing Chorus	Fantasy World
	6/8MarchingKids	Soulful Wonder	SentimentalMovie	Relax Swing	Movie Pirates
	Light Waltz	Lovely & Soulful	BeautyCinemaBld	Urban Lounge	Chorus Symphony
	OrchestraWaltz*A	Danceable Funk	CinemaSymphoBld	Broadway Tap	Hollywood Sound
	OrchestraWaltz*B	Bright Pop Rock	Enka Ballad		Super Showtune
	OrchestraWaltz*C	AmericanHardRock	6/8 Enka Shuffle		TV Drama Track*A
	OrchestraWaltz*D	Power Rock 80s	Christmas Ballad		TV Drama Track*B
		USA RockStandard			Movie Symphonic
				Movie Soundtrack	
3	8Beat Synth Pop	Seaside Rock	Disco Hits 70s	Brazilian Bossa	Yoo-Hoo Polka
	8Beat Pop	70s Folk Rock	70s Disco Night	Lounge BossaNova	Pop Polka
	Pop Shuffle	Alternative Rock	Euro Pop Disco	8Beat Bossa Nova	Funny Polka
	R&B Shuffle	Alternative6/8Rk	Synth Disco	Pop Bossa Nova	Casual Polka
	Rock	Highway Rock	Ballroom Disco	Tiny Bossa Nova	Country Town
	Rock Shuffle	Funky Rock&Roll	SynDancePop 80s	Cafe Samba	Tango Band
	Rock Pop Ballad	Synth Pop Rock	Dirty Dance Beat	BitterSweetLatin	Turkish Pops
	Funk	Power Synth Rock	Fortune Disco	Latin Rock	Oriental Dance
		RockGuitarBallad	Girls Pop 48 *A	DanceBeatLatin*A	Celtic Beat
		Pop Rock&Roll	Girls Pop 48 *B	DanceBeatLatin*B	Celtic Waltz
		Back To The 60s	Shiny Girls Pop	Pop Accordion	Trad Irish Pipe
	Dancing Boogie	Share The Peace	Sweet Bomba	Irish Ballad	
4	Dance Pop	6/8 Shuffle Rock	DanceAndRhythm*A	Orquesta Salsa	ChinaSweetBallad
	Disco Pop	ShuffleBoysRock	DanceAndRhythm*B	New Flamenco	ChinaRomanticBld
	R&B E.Piano Bld	Shuffle Pop Rock	DanceAndRhythm*C	Jummin' Reggae	China Dance Beat
	R&B Piano Ballad	Shfl Rock Ballad	DanceAndRhythm*D	RumbaAndTheCity	China Kung Fu
	8Beat Ballad	Pop Rock Band	Girls Techno	French Caribbean	China Trad Song
	8BeatOrchBallad	ShufflePopPiano	Candy Pop Techno	Caribbean Sea	China Trad Dance
	3/4 Pop Ballad	Contemp. Country	Dancing Platform		
	6/8 Pop Ballad	Smooth Country	Dance Beat EX.		
		Xmas Shuffle	Club Beat		
		Snowy Christmas	Electronica Beat		
			Kool Garage		
		Electronic Dance			
5	BigBand King *A	Pretty Rock	New Age Chillout		
	BigBand King *B	Ultra Rock	Eurobeat Party		
	BigBand King *C	Rock Graffiti	Ibiza Trance		
	BigBand Swing	Casual Rock	Casual Trance		
	Jazz Session	Rookie Rock	Trance Party		
	Fusion Samba	Happy Rock	WonderTranceShfl		
	Pop Samba	J-Pop Idol Rock			
	Simple Bossanova	J-Pop Band Rock			
	Mambo	Spirit Pop			
	Rumba	Sweet Love Pop			
		Summer Pop			
	Shaky Dance				

Registration Menu

Page	REGISTRATION MENU 1 02 SIMPLE	REGISTRATION MENU 2 02 POPS & ROCK	REGISTRATION MENU 3 02 DANCE & BALLAD	REGISTRATION MENU 4 02 JAZZ & LATIN	REGISTRATION MENU 5 02 SYMPHONY & WORLD
6	Cls Organ Chapel	J-Pop Piano Band			
	Cls Organ Hall	J-Pop Boys			
	RockOrganBallad	J-PopShuffleBeat			
	R&B Rock Organ	J-Pop BandBallad			
	Organ Combo	Breezy Ballad			
	6/8 Organ Ballad	HeroRangerTheme			
	Soul Jazz Organ	Sunset Pop			
	Pop Organ 60s	Funky Punch *A			
	Toy Organ	Funky Punch *B			
	Theatre Organ NY	GlxyBattleship*A			
	Nostalgic Organ	GlxyBattleship*B			
7		J-Pop Anime *A			
		J-Pop Anime *B			
		70s Honey			
		70s Hero			
		DBZ *A			
		DBZ *B			
		DBZ *C			
		DBZ *D			

Confirming the Electone Version

You can confirm the version of your Electone by the following procedure.

1 Press the [UTILITY] button.

The Utility display appears.

2 On the GLOBAL page, press the [Version] button in the display.

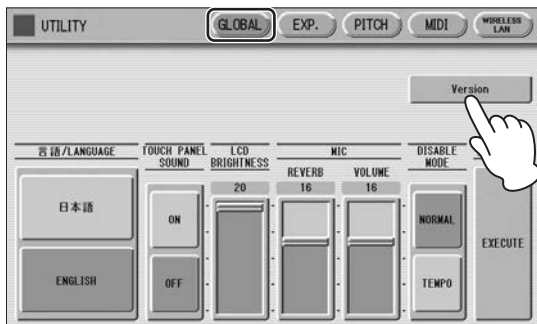

The Version dialog appears in the display. Pressing [OK] closes the dialog.

About the latest Firmware Version

Yamaha may from time to time update firmware of the product without notice for improvement. We recommend that you check our web site for the latest releases and upgrade your firmware of the Electone.

<http://download.yamaha.com/>

Note that the explanations in this Owner's Manual apply to the version of firmware when this Owner's Manual was produced.

Factory Set (Initializing the Electone)

All current settings including Registration Memory, User Voices, User Rhythms, and LCD display settings can be deleted at once by the following procedure. Note that the operation here does not affect the settings of the wireless LAN settings, which can be initialized on page 200.

Reference page

- Saving Registrations (page 118)
- Initialize the wireless LAN settings (page 200)

1 Turn off the power.

2 While holding down the ENDING [1] button, turn the power back on.

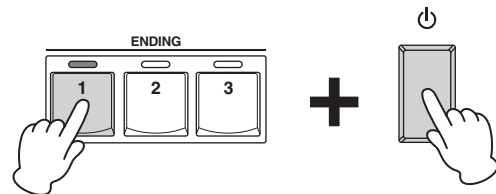

3 Release the ENDING [1] button after Voice Display appears.

If you don't want to reset the LCD display settings, you can initialize only the Registration settings. See page 98 for more information.

Reference page

- Initializing Registration Memory (page 98)

NOTICE

Executing the Factory Set will erase all your existing data. Always save your important data to the USB flash drive.

2 Voices

This Electone features more than 900 high-quality Voices. Any of these Voices can be used on the Upper Keyboard, Lower Keyboard and Pedalboard. Up to four Voice sections are available on the Upper Keyboard for playing together in a layer, while the Lower Keyboard and Pedalboard each have two Voice sections.

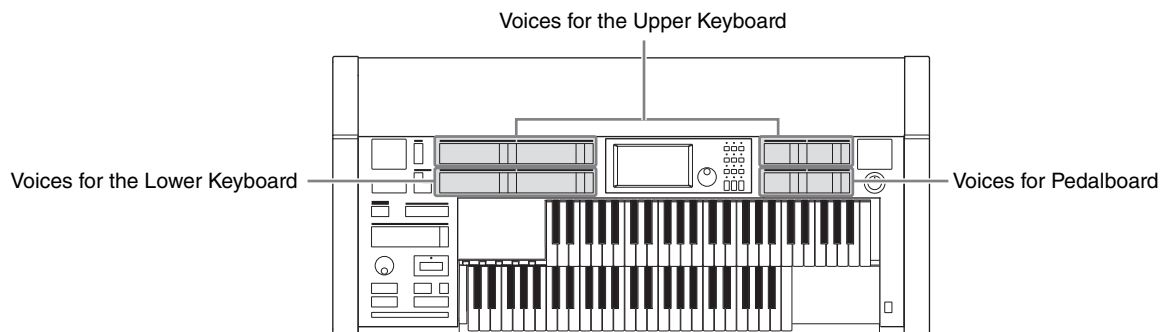

Voices for Each Keyboard

Voices for the Upper Keyboard

Up to four different Voice sections are available on the Upper Keyboard for playing together: Upper Keyboard Voice 1, Upper Keyboard Voice 2, Lead Voice 1, and Lead Voice 2. Voices for each section can be selected from the panel.

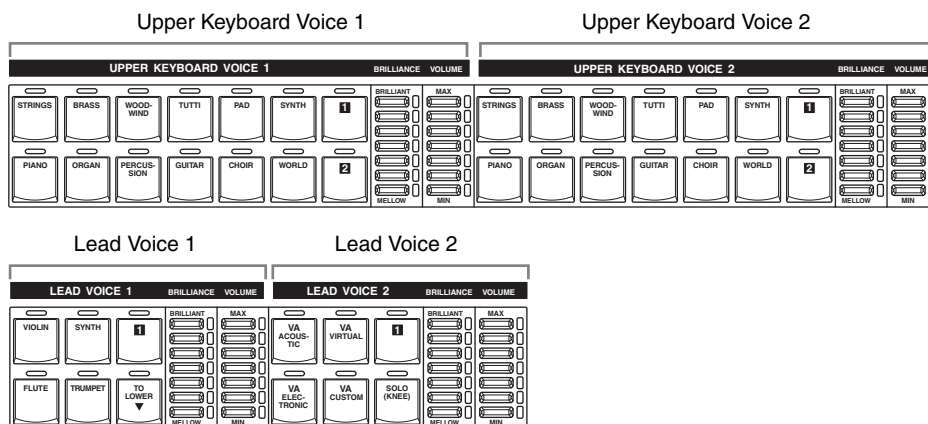

Lead Voice 1 and 2 sound only the highest note (or last note played) if two or more keys are played together. This makes the Lead Voices ideal for “lead” or solo instruments such as Trumpet and Saxophone. Lead Voice 2 of the ELS-02C includes additional, exclusive VA Voices (ELS-02C only) which are not available in other Voice sections.

Reference page

- Tone Generators of the ELS-02 Series (page 39)

Voices for the Lower Keyboard

Up to two different Voice sections are available on the Lower Keyboard for playing together: Lower Keyboard Voice 1 and Lower Keyboard Voice 2. Voices for each section can be selected from the panel.

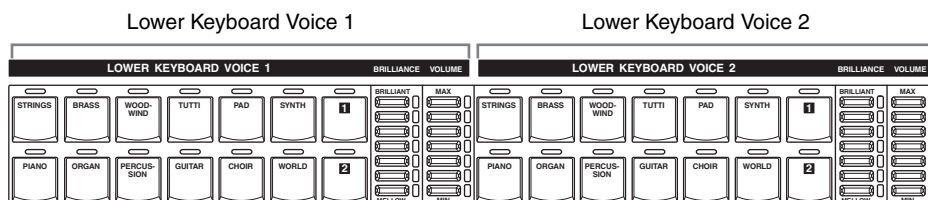

Voices for the Pedalboard

Up to two different Voice sections are available on the Pedalboard for playing together: Pedal Voice 1 and Pedal Voice 2. Voices for each section can be selected from the panel. By default, Pedal Voices 1 and 2 sound only the highest note if two or more pedals are played.

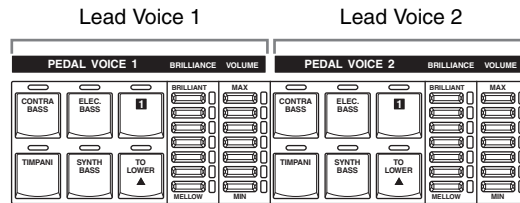

Reference page
 • POLY (page 44)

Selecting Voices with the Voice Buttons

Since selection of Voices follows the same procedure throughout all Voice sections, instructions for only the Upper Keyboard Voice 1 are given here.

1 Press one of the Voice buttons in the Upper Keyboard Voice 1 section.

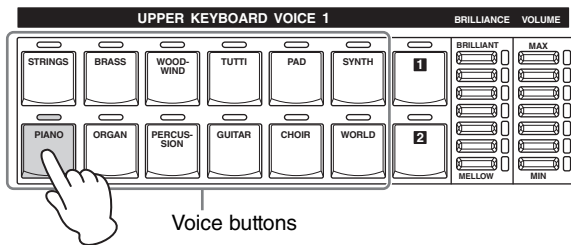

For example, if you have pressed the [PIANO] button, the following display (Voice Menu) will appear.

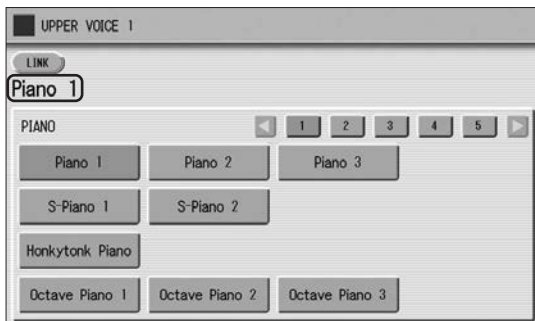

2 Select the desired Voice name from the Voice menu.

The Voice menu contains many Piano Voices, more than can fit on one display page. To change the display pages, press the appropriate number buttons in the display.

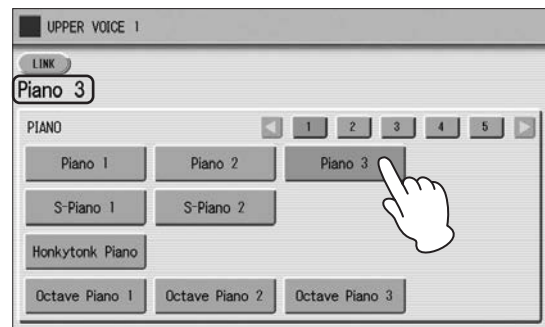

The color of the selected Voice name changes to orange, indicating that it has been selected.

Registering a Voice to Voice Link

By using the [LINK] button at the left top in the display, you can register the current Voice with all its settings on the Voice Condition display. This function lets you collect your favorite Voices, which can then be called up quickly or conveniently during your performance. The registered Voice can be selected from the “Voice Link” category on the display called up via the User buttons of all the Voice Sections. For detailed instructions, see page 50.

Changing the Voice volume

There are two ways to set the Voice volume: using the VOLUME buttons on the panel and using the volume slider in the display. The VOLUME buttons let you make coarse adjustments to the volume while the slider gives you fine control.

Using the VOLUME buttons on the panel (coarse)

Press one of the VOLUME buttons of the desired Voice section on the panel to set the level for each Voice. The buttons have seven volume settings, from a minimum of 0, or no sound, to a maximum of full volume.

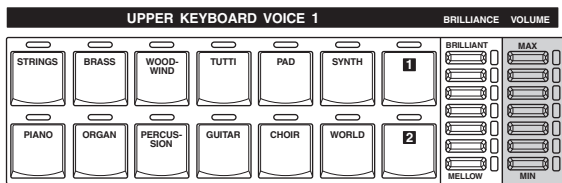

Using VOLUME slider in the display (fine)

Pressing the same Voice button on the panel again (or pressing the Voice name of the selected Voice in the display) calls up the Voice Condition display.

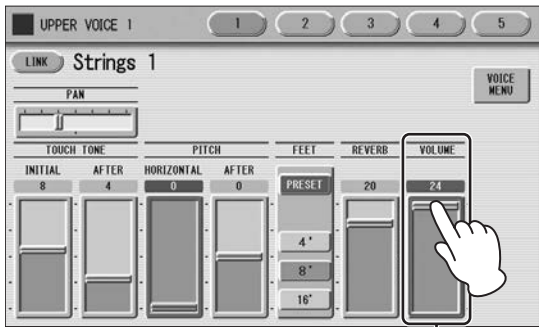

VOLUME slider

To set the volume, touch the VOLUME slider in the display or use the Data Control dial. The control range is from 0 (no sound) to 24 (full volume).

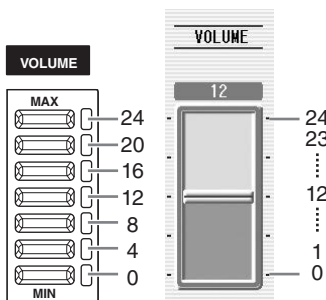

NOTE

Depending on the volume value (set by the slider), two adjacent VOLUME button lamps may be lit at the same time, indicating an intermediate position.

Calling up the Voice Menu display and Voice Condition display alternatively

Pressing a Voice button once calls up the Voice Menu display for the selected button. Pressing it a second time calls up the Voice Condition display. Successive presses alternate between the two displays.

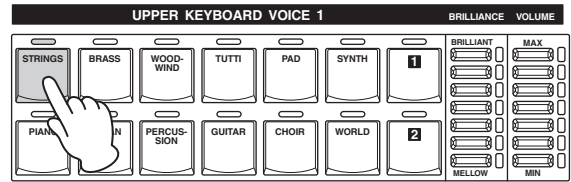

Voice Menu display

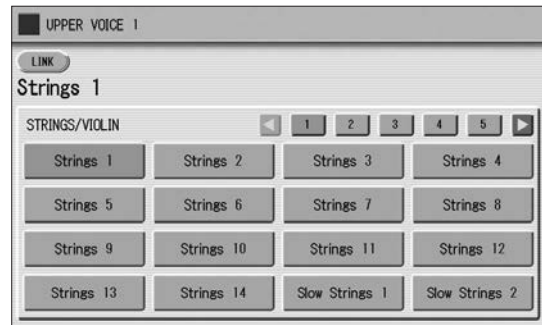

Voice Condition display

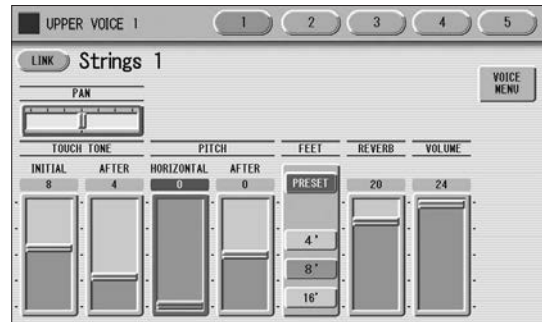

When the Voice Condition display is shown, pressing the [VOICE MENU] button on the display also calls up the Voice Menu.

From the Voice Condition display, you can control Voice-related parameters such as Pan, Effect, Volume, and so on. For more information on the Voice Condition display, see page 43.

NOTICE

Turning the Electone off erases all panel settings you have made.

If you wish to keep the panel settings you have made, save them to a USB flash drive before turning the Electone off (page 118).

About the To Lower function

Voices selected for the Lead Voice 1, Pedal Voice 1, and Pedal Voice 2 sections can also be played on the Lower Keyboard when the [TO LOWER] button in each section is on. When [TO LOWER] is on, the Lead Voice and Pedal Voice cannot be played on the Upper Keyboard and Pedalboard, respectively. The To Lower function is not available in the Lead Voice 2 section.

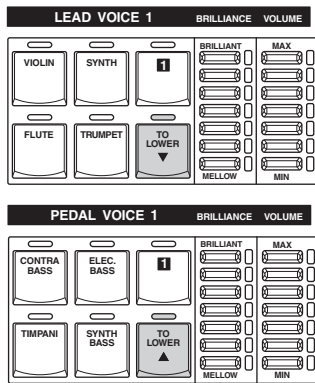

About the Solo function

The Lead Voice 2 section features an exclusive Solo function. Solo lets you instantly switch to a solo Lead Voice in the middle of your performance, muting all other Upper Keyboard Voices.

1 Select the Voice that you wish to play solo in the Lead Voice 2 section.

When the lamp of the [SOLO (KNEE)] button is turned off, all the Voices for Upper Keyboard (Upper Keyboard Voice 1 and 2, and Lead Voice 1 and 2) can be played.

2 Press the [SOLO (KNEE)] button in the Lead Voice 2 section.

This sets Solo to standby status.

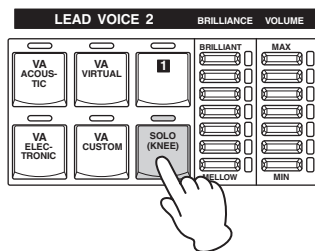

3 To use Solo, unfold the knee lever. (Bring it down into position.)

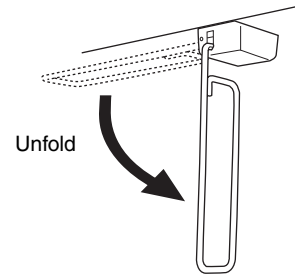

In this condition (Solo on), only the Lead Voice 2 is playable on the Upper Keyboard. (All other Voices are muted.)

4 To temporarily turn Solo off as you play, press the Knee Lever to the right with your knee.

In this condition, all Voices set to the Upper Keyboard except for Lead Voice 2 are playable on the Upper Keyboard. (Only Lead Voice 2 is muted.)

Each time you press the Knee Lever (Solo off) you can play all Voices except Lead Voice 2, and each time you release it (Solo on) you can play only Lead Voice 2 on the Upper Keyboard.

Notes on using Solo

- The knee lever can be used to control other functions, such as switching Sustain. When other functions are assigned to the knee lever, pressing knee lever turns these functions on at the same time.
- When you release the knee lever, Solo is not applied to the key being pressed, but is applied from the next pressed key. When you press the knee lever, Solo remains active for the key being pressed, and is cancelled from the next pressed key.
- Lead Voices 1 and 2 sound only the highest note if two or more keys are played. However, in the Solo mode, Lead Voice 2 sounds for the last key played.

Reference pages

- Knee Lever (page 180)
- Voice Condition Display (page 43)

Selecting Voices from the User Buttons

This Electone has a wide variety of Voices from which you can choose — far greater than what is immediately apparent from the Voice buttons on the panel. Each Voice section has one or two User buttons (numbered 1 or 2) which can be found at the right side of each Voice section. You can use the User buttons to select Voices that cannot be selected normally from the Voice buttons — such as Contrabass for the Upper Keyboard Voice.

1 Press one of the User buttons in any of the Voice sections.

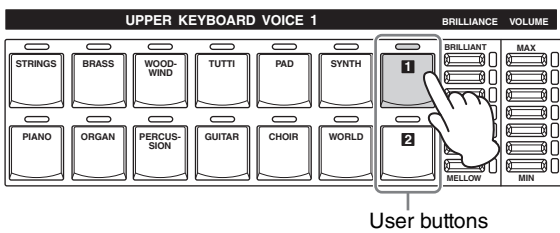

2 Select the desired instrument category with the category buttons in the display.

You can also choose the “USER” category to select a User Voice you have created.

Reference page
 • Voice Edit (page 138)

If you select “Voice Link” as Category, you can select a Voice with the settings made on the Voice Condition display (page 43).

Reference page
 • Using Voice Link (page 50)
 • Selecting a Voice registered to Voice Link (page 50)

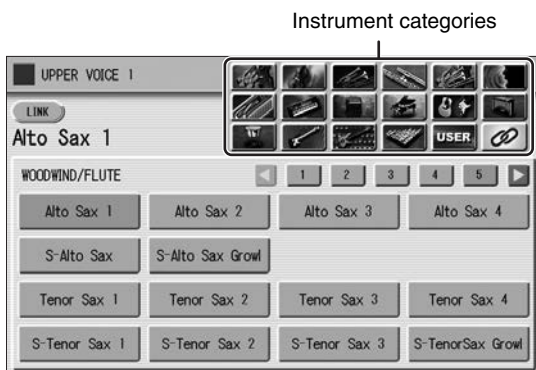

For example, to call up Marimba 1, select the Percussion category.

Reference page
 • Voice List (page 29)

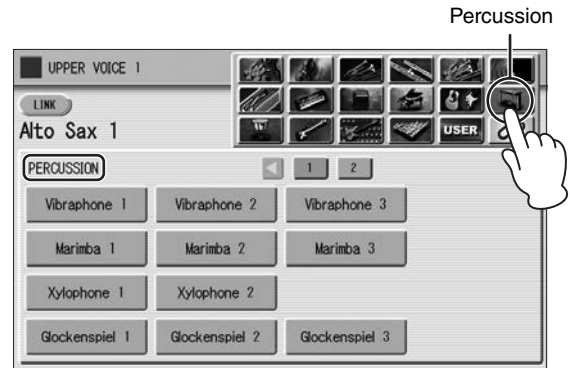

The name of the selected category (Percussion) is displayed on the upper left.

The Voice name shown under the category name is that of the currently assigned Voice and is irrelevant to the Voice menu below.

To directly select the desired category, hold down one of the User buttons and simultaneously press the desired Voice button.

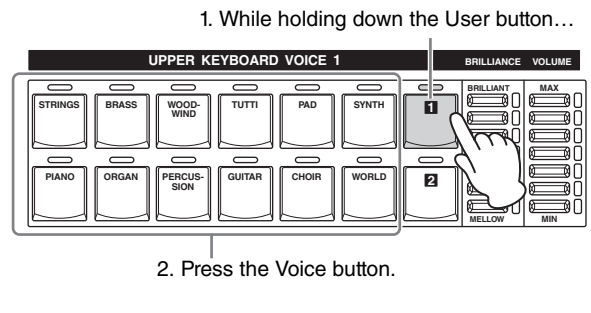

3 Select a Voice (Marimba 1, for example) from the displayed Voice Menu.

Pressing the number buttons in the display calls up the other Voices in the category.



The Voice name of the selected Voice (Marimba 1) appears above the category name, indicating that the Voice has been selected.

Voice List

This list shows all available Voices on the Electone. Numbers written at the left side of each column in this list indicate the numbered buttons displayed in the Voice Menu.

ELS-02/ELS-02C

STRINGS/VIOLIN

1	Strings 1	
	Strings 2	
	Strings 3	
	Strings 4	
	Strings 5	
	Strings 6	
	Strings 7	
	Strings 8	
	Strings 9	
	Strings 10	
	Strings 11	
	Strings 12	
	Strings 13	
	Strings 14	
	Slow Strings 1	
Slow Strings 2		
2	Chamber Strs 1	
	Chamber Strs 2	
	Chamber Strs 3	
	Chamber Strs 4	
	Chamber Strs 5	
	Violin Section	
	Viola Section	
	Cello Section	
	S-Strings 1	
	S-Strings 2	
	S-Strings 3	
	3	Pizzicato Strs 1
		Pizzicato Strs 2
Pizzicato Strs 3		
Pizzicato Strs 4		
Pizzicato Strs 5		
Tremolo Strings1		
Tremolo Strings2		
Tremolo Strings3		
SpiccatoStrings1		
SpiccatoStrings2		
SpiccatoStrings3		
4		Strings1&7
		Strings2&Viola
	Strings3&4	
	Strings7&Violin5	
	Violin5&Cello	
	Octave Strings 1	
	Octave Strings 2	
	Octave Strings 3	

5	Violin 1
	Violin 2
	Violin 3
	Violin 4
	Violin 5
	Violin 6
	Violin 7
	Violin 8
	S-Violin 1
	S-Violin 2
6	Pizzicato Violin
	Viola
	Cello 1
Cello 2	

CONTRABASS

1	Contrabass 1
	Contrabass 2
	Contrabass 3
	Contrabass 4
	Contrabass 5
	Contrabass 6
	Contrabass 7
	Pizzicato Bass 1
	Pizzicato Bass 2
	2
Acoustic Bass 2	
Acoustic Bass 3	
Acoustic Bass 4	
Acoustic Bass 5	
Bass & Cymbal	
S-AcousticBass 1	S-AcousticBass 1
	S-AcousticBass 2

BRASS/TRUMPET

1	Brass Section 1
	Brass Section 2
	Brass Section 3
	Brass Section 4
	Brass Section 5
	Brass Section 6
	Brass Section 7
	Brass Section 8
	Brass Section 9

1	Power Brass 1
	Power Brass 2
	Power Brass 3
2	Soft Brass 1
	Soft Brass 2
	Soft Brass 3
	S-BrsSect.Legato
	S-BrsSect.Fall
	S-BrsSect.Up
	Brass Fall
3	Trombone Sec 1
	Trombone Sec 2
	Trombone Sec 3
	Trombone Sec 4
	Trombone Sec 5
	Trombone Sec 6
	Trombone Sec 7
4	Brass1&Trp6
	Brass2&Trp6
	Horn 1&4
	Trumpet & Cornet
	Octave Brass 1
	Octave Brass 2
	Octave Brass 3
	Octave Brass 4
	Octave Brass 5
Octave Brass 6	
Octave Brass 7	
Octave Brass 8	
Octave Brass 9	
5	Trumpet 1
	Trumpet 2
	Trumpet 3
	Trumpet 4
	Trumpet 5
	Trumpet 6
	Trumpet 7
	Trumpet 8
	Trumpet 9
	Trumpet 10
	Trumpet 11
Trumpet 12	
S-Trumpet 1	S-Trumpet 1
	S-Trumpet 2
	S-Trumpet Fall
S-Trumpet Shake	S-Trumpet Shake
	S-Trumpet Shake
6	Muted Trumpet 1

6	Muted Trumpet 2
	Muted Trumpet 3
	Muted Trumpet 4
	Cornet
	Muted Cornet
	Flugel Horn 1
Flugel Horn 2	
7	Trombone 1
	Trombone 2
	Trombone 3
	Trombone 4
	Trombone 5
	S-Trombone
	Muted Trombone 1
Muted Trombone 2	
8	Horn 1
	Horn 2
	Horn 3
	Horn 4
	Horn 5
	Horn 6
	Horn 7
	Horn 8
	Horn 9
S-Horn Section	
Muted Horn 1	
Muted Horn 2	
9	Tuba 1
	Tuba 2
	Euphonium
	Brass Bass 1
Brass Bass 2	
Brass Bass 3	

WOODWIND/FLUTE

1	Flute 1
	Flute 2
	Flute 3
	Flute 4
	Flute 5
	S-Flute
	S-Flute Flutter
	Piccolo
2	Recorder 1
	Recorder 2
	Ocarina

Voices whose names begin with the prefix "S-" are referred to as "Super Articulation Voices." For information about what sound is produced when you play these Voices, see "Super Articulation Voice Supplementary List" on page 34. For details about Super Articulation Voices, see page 39.

Voice List

2	Whistle	
3	Clarinet 1	
	Clarinet 2	
	Clarinet 3	
	Clarinet 4	
	Clarinet 5	
	Clarinet 6	
	S-Clarinet 1	
	S-Clarinet 2	
	Bass Clarinet	
4	Oboe 1	
	Oboe 2	
	Oboe 3	
	Oboe 4	
	Oboe 5	
	Oboe 6	
	English Horn 1	
	English Horn 2	
	Bassoon 1	
	Bassoon 2	
	Bassoon 3	
	5	Alto Sax 1
		Alto Sax 2
Alto Sax 3		
Alto Sax 4		
S-Alto Sax		
S-Alto Sax Growl		
Tenor Sax 1		
Tenor Sax 2		
Tenor Sax 3		
Tenor Sax 4		
S-Tenor Sax 1		
S-Tenor Sax 2		
S-Tenor Sax 3		
S-TenorSax Growl		
6		Soprano Sax 1
	Soprano Sax 2	
	S-Soprano Sax	
	S-SprnoSax Growl	
	Baritone Sax 1	
	Baritone Sax 2	
7	Sax Ens 1	
	Sax Ens 2	
	Sax Ens 3	
	Sax Ens 4	
	Sax Ens 5	
	Sax Ens 6	
8	Woodwind Ens 1	
	Woodwind Ens 2	
	Woodwind Ens 3	
	Woodwind Ens 4	
	Woodwind Ens 5	
	Woodwind Ens 6	
	Woodwind Ens 7	
	Clarinet&Flutes	
	Clarinet&Oboe	

8	Flutes&Oboes
	Woodwind&Glocken

TUTTI

1	Strings&Winds
	Strings&Brass 1
	Strings&Brass 2
	Strings&Brass 3
	Strings&Horn 1
	Strings&Horn 2
	Strings&Choir
	Trumpets&Winds
	Horns&Winds
	Orchestra Bass
2	Brass&Sax 1
	Brass&Sax 2
	Brass&Sax 3
	Brass&Sax 4
	Brass&Sax 5
	Brass&Sax Oct
	Brass&Sax Unis
	Brass&Winds 1
	Brass&Winds 2
	3
Orchestra Hit 2	
Orchestra Hit 3	
Orchestra Hit 4	

CHOIR

1	Choir 1
	Choir 2
	Choir 3
	Choir 4
	Choir 5
	Choir 6
	Choir 7
	Choir 8
	Choir 9
	Choir 10
	Choir 11
2	Vocal
	S-ChoirSoft Aah
	S-ChoirBoys Aah
	S-ChoirSoft Ooh
3	S-ChoirBoys Ooh
	Gospel Choir 1
	Gospel Choir 2
	Gospel Choir 3
	S-GsplChr Hmm
	S-GsplChr Hm/Ah
	S-GsplChr Wow
	S-GsplChr W/Hey
S-GsplChr Hey	

4	PopVocals Haa 1
	PopVocals Haa 2
	PopVocals Ooh 1
	PopVocals Ooh 2
	PopVocals Ooh 3
	PopVocals Aah
	PopVocals Baa
	PopVocals Bee
	PopVocals Daa
	PopVocals Doo
	PopVocals Mmh
	PopVocals Wah
	PopVocals Yoo
5	S-ShoBeDoBa/Hmm
	S-ShoBeDoBa/Wah
	S-ShoBeDoBa/Doo
	S-ShoBaDoBa/Daa
	S-DoBaBe/Shoo
	S-DoBeDoBe/Wah
	S-DoBeBaDa/DoWe
	S-BaDaYah/Doo
	S-YaBaDaBa/Doo
	S-Scat/Doo
S-Scat/DoWe	
6	S-Scat/SFX 1
	S-Scat/SFX 2
	S-WhtShouldWeDo
	S-WhoAreYou/Wee
	S-DoWeYouBe/Wah
	S-HaaVibrato/SFX
	S-OohVibrato/SFX
	S-OohBoysVib/SFX
	S-OhGirlsVib/SFX
	S-DooVibrato/SFX
S-DooBoys/SFX	
S-DooGirls/SFX	
S-DaaVibrato/SFX	
S-BaaVibrato/SFX	
S-WahVibrato/SFX	
S-YooVibrato/SFX	

PAD

1	Smooth Pad 1
	Smooth Pad 2
	Smooth Pad 3
	Smooth Pad 4
	Smooth Pad 5
	Smooth Pad 6
	Smooth Pad 7
	Smooth Pad 8
	Smooth Pad 9
2	Resonance Pad 1
	Resonance Pad 2
	Resonance Pad 3
	Resonance Pad 4

2	Resonance Pad 5	
	Resonance Pad 6	
	Resonance Pad 7	
	Resonance Pad 8	
	Resonance Pad 9	
	Resonance Pad 10	
	Resonance Pad 11	
	3	Bell Pad 1
		Bell Pad 2
		Bell Pad 3
		Bell Pad 4
Bell Pad 5		
Bell Pad 6		
Bell Pad 7		
Bell Pad 8		
Bell Pad 9		
Bell Pad 10		
Bell Pad 11		
Bell Pad 12		
4	Space Pad 1	
	Space Pad 2	
	Space Pad 3	
	Space Pad 4	
	Space Pad 5	
	Space Pad 6	
	Space Pad 7	
	Space Pad 8	
	Space Pad 9	
	Space Pad 10	
5	Galaxy Pad 1	
	Galaxy Pad 2	
	Galaxy Pad 3	
	Galaxy Pad 4	
	Galaxy Pad 5	
6	Bright Pad 1	
	Bright Pad 2	
	Bright Pad 3	
	Bright Pad 4	
	Bright Pad 5	
7	Noisy Pad 1	
	Noisy Pad 2	
	Noisy Pad 3	
	Noisy Pad 4	
	Noisy Pad 5	
	Noisy Pad 6	
7	Ambi Pad 1	
	Ambi Pad 2	
	Ambi Pad 3	
	Ambi Pad 4	
	Ambi Pad 5	
	Ambi Pad 6	
	Warm Pad 1	
	Warm Pad 2	
Warm Pad 3		
Warm Pad 4		
Warm Pad 5		

Voices whose names begin with the prefix "S-" are referred to as "Super Articulation Voices." For information about what sound is produced when you play these Voices, see "Super Articulation Voice Supplementary List" on page 34. For details about Super Articulation Voices, see page 39.

7	Warm Pad 6
8	Dark Pad 1
	Dark Pad 2
	Dark Pad 3
	Dark Pad 4
	Dark Pad 5
	Dark Pad 6
	Dark Pad 7
	Dark Pad 8
	Dark Pad 9
9	Vox Pad 1
	Vox Pad 2
	Vox Pad 3
	Vox Pad 4
	Vox Pad 5
	Vox Pad 6
10	Sweep Pad 1
	Sweep Pad 2
	Sweep Pad 3
	Sweep Phase
	Sweep Flanger 1
	Sweep Flanger 2
11	Metallic Pad 1
	Metallic Pad 2
	Metallic Pad 3
	SFX Pad 1
	SFX Pad 2
	SFX Pad 3

SYNTH

1	Synth Lead 1
	Synth Lead 2
	Synth Lead 3
	Synth Lead 4
	Synth Lead 5
	Synth Lead 6
	Synth Lead 7
	Synth Lead 8
	Synth Lead 9
2	Fat Saw Lead 1
	Fat Saw Lead 2
	Fat Saw Lead 3
	Fat Saw Lead 4
	Fat Saw Lead 5
	Fat Saw Lead 6
	Filter Lead 1
	Filter Lead 2
	Filter Lead 3
	Filter Lead 4
	Filter Lead 5
	Filter Lead 6
	Filter Lead 7
	3
Soft Lead 2	
Soft Lead 3	

3	Soft Lead 4	
	Soft Lead 5	
	Soft Lead 6	
	Soft Lead 7	
	Early Lead 1	
	Early Lead 2	
	PWM Lead 1	
	PWM Lead 2	
	Chorus Saw Lead1	
	Chorus Saw Lead2	
	Chorus Saw Lead3	
	4	Vintage Lead 1
		Vintage Lead 2
Vintage Lead 3		
Vintage Lead 4		
Vintage Lead 5		
Vintage Lead 6		
Vintage Lead 7		
5	Dance Chords 1	
	Dance Chords 2	
	Dance Chords 3	
	Dance Chords 4	
	Dance Chords 5	
Club Lead 1	Club Lead 1	
	Club Lead 2	
	Club Lead 3	
6	Pop Lead 1	
	Pop Lead 2	
	Pop Lead 3	
	Pop Lead 4	
	Pop Lead 5	
	Pop Lead 6	
	Pop Lead 7	
7	Synth Cla 1	
	Synth Cla 2	
	Synth Cla 3	
	Synth Cla 4	
	Synth Cla 5	
	Synth Cla 6	
	Synth Cla 7	
	Synth Cla 8	
	Synth Cla 9	
	Synth Cla 10	
Synth Sax		
Synth Trumpet		
Synth Violin		
8	Synth Brass 1	
	Synth Brass 2	
	Synth Brass 3	
	Synth Brass 4	
	Synth Brass 5	
	Synth Brass 6	
	Synth Brass 7	
	Synth Brass 8	
	Synth Brass 9	
	Synth Brass 10	

8	Synth Brass 11
	Synth Brass 12
	Synth Brass 13
9	Fat Synth Brass1
	Fat Synth Brass2
	Fat Synth Brass3
	Fat Synth Brass4
	DetunedSawBrass1
	DetunedSawBrass2
	DetunedSawBrass3
	Soft Syn Brass 1
	Soft Syn Brass 2
	PWM Brass Slow
	PWM Brass Fast
	Funky Analog
	10
Synth Strs 2	
Synth Strs 3	
Synth Strs 4	
Synth Strs 5	
Synth Strs 6	
Synth Strs 7	
Synth Strs 8	
Synth Strs 9	
Synth Strs 10	
Synth Strs 11	
Synth Strs 12	
Synth Strs 13	
11	LightSynStrings1
	LightSynStrings2
	LightSynStrings3
	LightSynStrings4
	MovinSynStrings1
	MovinSynStrings2
	FatSynStrings 1
	FatSynStrings 2
	FatSynStrings 3
	FatSynStrings 4
	Oct Synth Strs 1
	Oct Synth Strs 2
	Oct Synth Strs 3
12	Synth Bell 1
	Synth Bell 2
	Synth Bell 3
	Synth Bell 4
	Synth Bell 5
	Synth Bell 6
	Synth Bell 7
13	Sky Bell 1
	Sky Bell 2
	Vox Bell 1
	Vox Bell 2
	Pop Synth Bell 1
	Pop Synth Bell 2
	Pop Synth Bell 3
	Pop Synth Bell 4

13	Pop Synth Bell 5
14	Synth Decay 1
	Synth Decay 2
	Synth Decay 3
	Synth Decay 4
	Synth Pluck 1
	Synth Pluck 2
Synth Pluck 3	
Synth Pluck 4	
Synth Pluck 5	
Synth Pluck 6	
15	Synth Seq 1
	Synth Seq 2
	Synth Seq 3
	Trance Seq 1
	Trance Seq 2
	Trance Seq 3
	Trance Seq 4
	Percussive Seq 1
	Percussive Seq 2
	Percussive Seq 3
Percussive Seq 4	
Percussive Seq 5	
Percussive Seq 6	

ORGAN

1	Pipe Organ 1
	Pipe Organ 2
	Pipe Organ 3
	Pipe Organ 4
	Pipe Organ 5
	Pipe Organ 6
	Pipe Organ 7
	Pipe Organ 8
	Pipe Organ 9
	Pipe Organ 10
2	Theatre Organ 1
	Theatre Organ 2
	Theatre Organ 3
	Theatre Organ 4
	Theatre Organ 5
	Theatre Organ 6
	Theatre Organ 7
	Theatre Organ 8
	Theatre Organ 9
	Theatre Organ 10
Thtr Tibia Full	
Thtr Tibia 8&4	
Thtr Tibia 16&4	
Thtr Tp & Kinura	
Thtr Vox & Tibia	
Thtr Trumpet16&8	
3	Harmonica 1
	Harmonica 2
	Harmonica 3

Voices whose names begin with the prefix "S-" are referred to as "Super Articulation Voices." For information about what sound is produced when you play these Voices, see "Super Articulation Voice Supplementary List" on page 34. For details about Super Articulation Voices, see page 39.

Voice List

3	Harmonica 4
	S-Harmonica
	S-BluesHarp
	Reed Organ
	Bandoneon 1
	Bandoneon 2
4	Accordion 1
	Accordion 2
	Accordion 3
	Accordion 4
	Accordion 5
	Accordion 6
	Accordion 7
	Accordion 8
	Accordion 9
	Accordion 10
	AccordionMuset.1
	AccordionMuset.2
	Accordion Full
	5
Jazz Organ 2	
Jazz Organ 3	
Jazz Organ 4	
Jazz Organ 5	
Jazz Organ 6	
Jazz Organ 7	
Jazz Organ 8	
Jazz Organ 9	
6	Jazz Organ Slow1
	Jazz Organ Slow2
	Jazz Organ Slow3
	Jazz Organ Fast1
	Jazz Organ Fast2
	Vintage Organ
	Vin Organ Slow 1
	Vin Organ Slow 2
	Vin Organ Fast 1
	Vin Organ Fast 2
Vin Organ Fast 3	
7	Tonewheel Organ1
	Tonewheel Organ2
	Tonewheel Organ3
	Tonewheel Organ4
	Tonewheel Organ5
8	Pop Organ 1
	Pop Organ 2
	Pop Organ 3
	Pop Organ 4
	Pop Organ 5
	Pop Organ 6
	Pop Organ Fast 1
	Pop Organ Fast 2
	Pop Organ Fast 3
	Combo Organ 1
	Combo Organ 2
	Combo Organ 3

8	Combo Organ 4
9	Rock Organ 1
	Rock Organ 2
	Rock Organ 3
	Rock Organ Slow1
	Rock Organ Slow2
	Rock Organ Slow3
	Rock Organ Slow4
	Rock Organ Slow5
	Rock Organ Slow6
	Rock Organ Slow7
	Rock Organ Slow8
	Rock Organ Fast1
	Rock Organ Fast2
10	Organ Bass 1
	Organ Bass 2
	Organ Bass 3
	Organ Bass 4

PIANO

1	Piano 1
	Piano 2
	Piano 3
	S-Piano 1
	S-Piano 2
	Honkytonk Piano
	Octave Piano 1
	Octave Piano 2
	Octave Piano 3
	2
Harpsichord 2	
Harpsichord 3	
S-Harpsichord	
Clavichord	
3	DX E.Piano 1
	DX E.Piano 2
	DX E.Piano 3
	DX E.Piano 4
	DX E.Piano 5
	DX E.Piano 6
	DX EP Sweet 1
	DX EP Sweet 2
	DX E.Piano&Pad 1
	DX E.Piano&Pad 2
Galaxy EP	
DX EP Dynamics	
4	Stage E.Piano 1
	Stage E.Piano 2
	Stage E.Piano 3
	Stage E.Piano 4
	Stage E.Piano 5
	Stage E.Piano 6
	S-Stage E.Piano1
	S-Stage E.Piano2
	S-Stage E.Piano3

4	S-Stage E.Piano4
	S-Stage E.Piano5
5	Stack E.Piano 1
	Stack E.Piano 2
	S-E.Grand CP80 1
	S-E.Grand CP80 2
	Clavi 1
	Clavi 2
	Clavi 3
	Clavi 4
	S-Clavi
	S-Muted Clavi

GUITAR

1	Nylon Guitar 1
	Nylon Guitar 2
	Nylon Guitar 3
	Nylon Guitar 4
	Nylon Guitar 5
	S-Nylon Guitar 1
	S-Nylon Guitar 2
2	Flamenco Guitar
	S-FlamencoGuitar
	Steel Guitar 1
	Steel Guitar 2
	Steel Guitar 3
	Steel Guitar 4
	SteelGuitarSlide
	SteelGuitar Mute
	S-Steel Guitar 1
	S-Steel Guitar 2
3	12Str Guitar 1
	12Str Guitar 2
	Jazz Guitar 1
	Jazz Guitar 2
	Jazz Guitar 3
	Jazz Guitar 4
	JazzGuitar Slide
Jazz Guitar Oct	
4	S-Jazz Guitar 1
	S-Jazz Guitar 2
	S-Jazz Guitar 3
	Elec Guitar 1
	Elec Guitar 2
	Elec Guitar 3
	Elec Guitar 4
	Elec Guitar 5
	Clean Guitar 1
	Clean Guitar 2
Clean Guitar 3	
Clean Guitar 4	
Clean Guitar 5	
Clean Guitar 6	
Clean Guitar 7	
Clean Guitar 8	

5	E.Guitar Amp 1
	E.Guitar Amp 2
	E.Guitar Amp 3
	E.Guitar Amp 4
	E.Guitar Amp 5
	E.Guitar Amp 6
	E.Guitar Amp 7
	Muted Guitar 1
	Muted Guitar 2
	Muted Guitar 3
	Muted Guitar 4
	S-Clean Solid 1
	S-Clean Solid 2
S-Clean Solid 3	
6	S-Clean Guitar 1
	S-Clean Guitar 2
	S-Clean Guitar 3
	S-Clean Guitar 4
	S-Clean Guitar 5
	S-Clean Guitar 6
	S-Clean Finger 1
	S-Clean Finger 2
	S-Clean Finger 3
	S-Clean Finger 4
7	S-CleanVintage 1
	S-CleanVintage 2
	S-CleanVintage 3
	Distortion Gtr 1
	Distortion Gtr 2
	Distortion Gtr 3
	Distortion Gtr 4
	Distortion Gtr 5
	Distortion Gtr 6
Distortion Gtr 7	
Distortion Gtr 8	
Distortion Gtr 9	
8	S-Dist Solid 1
	S-Dist Solid 2
	S-Dist Solid 3
	S-Dist Solid 4
	S-Dist Solid 5
	S-Dist Solid 6
	S-Dist Vintage 1
	S-Dist Vintage 2
S-Dist Crunch 1	
S-Dist Crunch 2	
S-Dist Finger 1	
S-Dist Finger 2	
9	Banjo 1
	Banjo 2
	Mandolin
	Pedal Steel Gtr1
	Pedal Steel Gtr2
	Pedal Steel Gtr3
	Harp 1
Harp 2	

Voices whose names begin with the prefix "S-" are referred to as "Super Articulation Voices." For information about what sound is produced when you play these Voices, see "Super Articulation Voice Supplementary List" on page 34. For details about Super Articulation Voices, see page 39.

9	Harp 3
	Harp 4
	Harp 5

PERCUSSION

1	Vibraphone 1
	Vibraphone 2
	Vibraphone 3
	Marimba 1
	Marimba 2
	Marimba 3
	Xylophone 1
	Xylophone 2
	Glockenspiel 1
	Glockenspiel 2
Glockenspiel 3	
2	Celesta 1
	Celesta 2
	Music Box 1
	Music Box 2
	Chime 1
	Chime 2
Chime 3	

TIMPANI

1	Timpani 1
	Timpani 2
	Timpani 3
	Timpani 4
	Timpani 5
	Timpani Roll 1
	Timpani Roll 2
	Timpani Roll 3
	Timpani Roll 4
	S-Timpani Roll
	S-Timpani Roll fp

ELECTRIC BASS

1	Fingered Bass 1
	Fingered Bass 2
	Fingered Bass 3
	Fingered Bass 4
	Fingered Bass 5
	Fingered Bass 6
	Fingered Bass 7
	Fingered Bass 8
	Fingered Bass 9
	Fingered Bass 10
	Fingered Bass 11
	S-Fingerd Bass 1
	S-Fingerd Bass 2
	S-Fingerd Bass 3

2	Slap Bass 1
	Slap Bass 2
	Slap Bass 3
	Slap Bass 4
	Slap Bass 5
	Slap Bass 6
3	Picked Bass 1
	Picked Bass 2
	Picked Bass 3
	Picked Bass 4
	Picked Bass 5
	Picked Bass 6
	Picked Bass 7
	Picked Bass 8
	Picked Bass 9
	Picked Bass 10
4	Fretless Bass 1
	Fretless Bass 2
	Fretless Bass 3
	Fretless Bass 4

SYNTH BASS

1	Funk Bass 1
	Funk Bass 2
	Funk Bass 3
	Funk Bass 4
	Funk Bass 5
	Funk Bass 6
	Funk Bass 7
	Funk Bass 8
	Funk Bass 9
	Funk Bass 10
2	Dance Bass 1
	Dance Bass 2
	Dance Bass 3
	Dance Bass 4
	Dance Bass 5
	Dance Bass 6
	Dance Bass 7
	Dance Bass 8
	Dance Bass 9
	Dance Bass 10
	Dance Bass 11
	Dance Bass 12
	Dance Bass 13
	Dance Bass 14
	Dance Bass 15
	Dance Bass 16
3	Smooth Bass 1
	Smooth Bass 2
	Smooth Bass 3
	Smooth Bass 4
	Smooth Bass 5
	Smooth Bass 6
	Smooth Bass 7

3	Smooth Bass 8
	Smooth Bass 9
	Smooth Bass 10
4	Deep Bass 1
	Deep Bass 2
	Deep Bass 3
	Deep Bass 4
	Deep Bass 5
	Deep Bass 6
5	Fat Bass 1
	Fat Bass 2
	Fat Bass 3
	Fat Bass 4
	Fat Bass 5
	Fat Bass 6
	Fat Bass 7
	Fat Bass 8
	Fat Bass 9
	Fat Bass 10

WORLD

1	Pan Flute 1
	Pan Flute 2
	S-Pan Flute 1
	S-Pan Flute 2
	S-Irish Pipe 1
	S-Irish Pipe 2
	Bagpipe
	Dulcimer 1
	Dulcimer 2
	Zither
2	Shakuhachi
	Yokobue
	Shamisen 1
	Shamisen 2
	Koto
Taishokoto	
3	Er Hu 1
	Er Hu 2
	Er Hu 3
	Ban Hu
	Ma Tou Qin
	Di Zi
	Suo Na
	Hu Lu Si
	Sheng
	Gu Zheng 1
	Gu Zheng 2
Yang Qin	
Pi Pa	
S-Pi Pa	
Liu Qin	
San Xian	
4	Nay
	Surnay

4	Oud
	Sitar 1
	Sitar 2
5	Kamanche
	Steel Drum
	Log Drum
	Kalimba

Voices whose names begin with the prefix "S-" are referred to as "Super Articulation Voices." For information about what sound is produced when you play these Voices, see "Super Articulation Voice Supplementary List" on page 34. For details about Super Articulation Voices, see page 39.

Super Articulation Voice Supplementary List

This list describes the effects that are produced by playing the Super Articulation Voices (having names beginning with the prefix “S-”). The meanings of the column titles are as follows:

- **Super Articulation**

Describes the effects produced just by playing the keyboard, regardless of the settings. For information about AEM in the list, see page 7. “Key-off Samples” refers to the special, characteristic sound which results when releasing the key.

- **Auto**

Describes the effects produced by playing the keyboard when setting AUTO (page 45) to ON in page 2 of the Voice Condition display. An effect marked with “(octave)” will be produced only when you play intervals of minor 7th, Major 7th or octave in legato.

- **ART.1 / ART.2**

Describes the effects produced by playing the keyboard with the left footswitch when selecting “ART.1” or “ART.2” of FOOT SWITCH LEFT in page 2 of the Voice Condition display. An effect indicated by “***/***” means a key-on effect/key-off effect. For example, “Grace Note/Bend Down” indicates that the Grace Note is added by pressing a key while turning on the Left Footswitch while the Bend Down is applied by releasing a key while turning on the Left Footswitch. An effect indicated by “Sound Effect” is applied when you just simply press the Left Footswitch. An effect having other indications is applied when you press a key while turning on the Left Footswitch.

- **Type**

Lists one of the four types A – D, each of which is determined by how you play the Voice. For example about each of four types, see page 39.

Category	Voice Name	Super Articulation	Auto	ART.1	ART.2	Type
STRINGS/ VIOLIN	S-Strings 1	Legato	–	–	–	
	S-Strings 2	Legato	–	–	–	
	S-Strings 3	Legato	–	–	–	
	S-Violin 1	Key-off Samples, Legato (AEM)	Bend Up, Bend Down, Portamento (Octave)	Bend Up / Bend Down	Grace Note / Bend Down	D
	S-Violin 2	Key-off Samples, Legato (AEM)	Portamento (Octave)	Grace Note / Bend Down	Bend Up / Bend Down	D
CONTRABASS	S-AcousticBass 1	Legato	–	Sound Effect	Sound Effect	A
	S-AcousticBass 2	Legato	–	Sound Effect	Sound Effect	A
BRASS/ TRUMPET	S-BrsSect.Legato	Legato	–	–	–	
	S-BrsSect.Fall		–	Fall Down	–	B
	S-BrsSect.Up		–	Glissando Up	–	B
	S-Trumpet 1	Legato (AEM)	Bend Up, Bend Down, Glissando (Octave)	Bend Up / Bend Down	Glissando Up / Glissando Down	D
	S-Trumpet 2	Legato (AEM)	Glissando (Octave)	Bend Up / Bend Down	Glissando Up / Glissando Down	D
	S-Trumpet Fall		–	Glissando Up	–	B
	S-Trumpet Shake		–	Shake	–	B
	S-Trombone	Legato (AEM)	Bend Up, Bend Down, Glissando (Octave)	Bend Up (Fast) / Bend Down	Bend Up (Slow) / Glissando Down	D
S-Horn Section	Legato	–	–	–		
WOODWIND/ FLUTE	S-Flute	Key-off Samples, Legato (AEM)	–	Grace Note / Bend Down	Glissando Up / Glissando Down	D
	S-Flute Flutter	Key-off Samples, Legato (AEM)	Grace Note, Glissando (Octave)	Grace Note / Bend Down	Glissando Up / Glissando Down	D
	S-Clarinet 1	Legato (AEM)	Grace Note, Glissando (Octave)	Bend Up / Bend Down	Glissando Up / Glissando Down	D
	S-Clarinet 2	Legato (AEM)	Bend Up, Bend Down, Glissando (Octave)	Bend Up / Bend Down	Glissando Up / Glissando Down	D
	S-Alto Sax	Key-off Samples, Legato (AEM)	Bend Up, Glissando (Octave)	Bend Up / Bend Down	Glissando Up / Glissando Down	D
	S-Alto Sax Growl	Key-off Samples, Legato (AEM)	Bend Up, Glissando (Octave)	Bend Up / Bend Down	Glissando Up / Glissando Down	D
	S-Tenor Sax 1	Key-off Samples, Legato (AEM)	Bend Up, Glissando (Octave)	Bend Up / Bend Down	Glissando Up / Glissando Down	D
	S-Tenor Sax 2	Legato (AEM)	Bend Up, Glissando (Octave)	Bend Up / Bend Down	Glissando Up / Glissando Down	D
	S-Tenor Sax 3	Legato (AEM)	Bend Up, Bend Down, Glissando (Octave)	Bend Up / Bend Down	Glissando Up / Glissando Down	D
	S-TenorSax Growl	Key-off Samples, Legato (AEM)	Bend Up, Glissando (Octave)	Bend Up / Bend Down	Glissando Up / Glissando Down	D
	S-Soprano Sax	Key-off Samples, Legato (AEM)	Grace Note, Glissando (Octave)	Grace Note / Bend Down (Fast)	Bend Up / Bend Down	D
	S-SprnoSax Growl	Key-off Samples, Legato (AEM)	Bend Up, Glissando (Octave)	Bend Up / Bend Down	Glissando Up / Glissando Down	D

Category	Voice Name	Super Articulation	Auto	ART.1	ART.2	Type
CHOIR	S-ChoirSoft Aah	Legato	–	–	–	
	S-ChoirBoys Aah	Legato	–	–	–	
	S-ChoirSoft Ooh	Legato	–	–	–	
	S-ChoirBoys Ooh	Legato	–	–	–	
	S-GsplChr Hmm	Key-off Samples, Legato	–	Sound Effect	Sound Effect	A
	S-GsplChr Hm/Ah		–	“Aah”	–	B
	S-GsplChr Wow	Key-off Samples, Legato	–	Sound Effect	Sound Effect	A
	S-GsplChr W/Hey		–	“Hey”	–	B
	S-GsplChr Hey	Key-off Samples, Legato	–	Sound Effect	Sound Effect	A
	S-ShoBeDoBa/Hmm	Scat Singing	–	“Hmm”	–	C
	S-ShoBeDoBa/Wah	Scat Singing	–	“Wah”	–	C
	S-ShoBeDoBa/Doo	Scat Singing	–	“Doo”	–	C
	S-ShoBaDoBa/Daa	Scat Singing	–	“Daa”	–	C
	S-DoBaBe/Shoo	Scat Singing	–	“Shoo”	–	C
	S-DoBeDoBe/Wah	Scat Singing	–	“Wah”	–	C
	S-DoBeBaDa/DoWe	Scat Singing	–	“DoWe”	–	C
	S-BaDaYah/Doo	Scat Singing	–	“Doo”	–	C
	S-YaBaDaBa/Doo	Scat Singing	–	“Doo”	–	C
	S-Scat/Doo	Scat Singing	–	“Doo”	–	C
	S-Scat/DoWe	Scat Singing	–	“DoWe”	–	C
	S-Scat/SFX 1	Legato	–	Sound Effect	Sound Effect	A
	S-Scat/SFX 2	Legato	–	Sound Effect	Sound Effect	A
	S-WhtShouldWeDo	Scat Singing	–	“Wah”	–	C
	S-WhoAreYou/Wee	Scat Singing	–	“Wee”	–	C
	S-DoWeYouBe/Wah	Scat Singing	–	“Wah”	–	C
	S-HaaVibrato/SFX	Key-off Samples, Legato	–	Sound Effect	Sound Effect	A
	S-OohVibrato/SFX	Legato	–	Sound Effect	Sound Effect	A
	S-OohBoysVib/SFX	Legato	–	Sound Effect	Sound Effect	A
	S-OhGirlsVib/SFX	Legato	–	Sound Effect	Sound Effect	A
	S-DooVibrato/SFX	Key-off Samples, Legato	–	Sound Effect	Sound Effect	A
	S-DooBoys/SFX	Key-off Samples, Legato	–	Sound Effect	Sound Effect	A
	S-DooGirls/SFX	Key-off Samples, Legato	–	Sound Effect	Sound Effect	A
	S-DaaVibrato/SFX	Legato	–	Sound Effect	Sound Effect	A
S-BaaVibrato/SFX	Legato	–	Sound Effect	Sound Effect	A	
S-WahVibrato/SFX	Legato	–	Sound Effect	Sound Effect	A	
S-YooVibrato/SFX	Legato	–	Sound Effect	Sound Effect	A	
ORGAN	S-Harmonica	Legato (AEM)	Grace Note, Bend Down, Legato (Octave)	Bend Up / Bend Down	Grace Note / Bend Down	D
	S-BluesHarp	Legato (AEM)	Grace Note, Bend Down, Legato (Octave)	Bend Up / Bend Down	Grace Note / Bend Down	D
PIANO	S-Piano 1	Key-off Samples	–	–	–	
	S-Piano 2	Key-off Samples	–	–	–	
	S-Harpsichord	Key-off Samples	–	–	–	
	S-Stage E.Piano1	Key-off Samples	–	–	–	
	S-Stage E.Piano2	Key-off Samples	–	–	–	
	S-Stage E.Piano3	Key-off Samples	–	–	–	
	S-Stage E.Piano4	Key-off Samples	–	–	–	
	S-Stage E.Piano5	Key-off Samples	–	–	–	
	S-E.Grand CP80 1	Key-off Samples	–	–	–	
	S-E.Grand CP80 2	Key-off Samples	–	–	–	
	S-Clavi	Key-off Samples	–	–	–	
	S-Muted Clavi	Key-off Samples	–	–	–	
	GUITAR	S-Nylon Guitar 1	Key-off Samples, Legato	–	Sound Effect	Sound Effect
S-Nylon Guitar 2			–	Harmonics	–	B
S-FlamencoGuitar		Key-off Samples, Legato	–	Sound Effect	Sound Effect	A
S-Steel Guitar 1		Key-off Samples, Legato	–	Sound Effect	Sound Effect	A
S-Steel Guitar 2			–	Harmonics	–	B
S-Jazz Guitar 1		Key-off Samples, Legato	–	Sound Effect	Sound Effect	A
S-Jazz Guitar 2		Key-off Samples, Legato	–	Sound Effect	Sound Effect	A
S-Jazz Guitar 3		Key-off Samples	–	Octave Playing	–	B

Voice List

Category	Voice Name	Super Articulation	Auto	ART.1	ART.2	Type	
GUITAR	S-Clean Solid 1	Key-off Samples, Legato	–	Sound Effect	Sound Effect	A	
	S-Clean Solid 2	Legato	–	Sound Effect	Sound Effect	A	
	S-Clean Solid 3	Legato	–	Sound Effect	Sound Effect	A	
	S-Clean Guitar 1	Key-off Samples	–	Harmonics	–	B	
	S-Clean Guitar 2		–	Harmonics	–	B	
	S-Clean Guitar 3	Key-off Samples, Legato	–	Sound Effect	Sound Effect	A	
	S-Clean Guitar 4		–	Sound Effect	Sound Effect	A	
	S-Clean Guitar 5	Key-off Samples, Legato	–	Sound Effect	Sound Effect	A	
	S-Clean Guitar 6	Key-off Samples, Legato	–	Sound Effect	Sound Effect	A	
	S-Clean Finger 1	Key-off Samples, Legato	–	Sound Effect	Sound Effect	A	
	S-Clean Finger 2	Key-off Samples, Legato	–	Sound Effect	Sound Effect	A	
	S-Clean Finger 3	Key-off Samples, Legato	–	Sound Effect	Sound Effect	A	
	S-Clean Finger 4	Key-off Samples, Legato	–	Sound Effect	Sound Effect	A	
	S-CleanVintage 1	Key-off Samples, Legato	–	Sound Effect	Sound Effect	A	
	S-CleanVintage 2	Key-off Samples, Legato	–	Sound Effect	Sound Effect	A	
	S-CleanVintage 3	Key-off Samples, Legato	–	Sound Effect	Sound Effect	A	
	S-Dist Solid 1	Key-off Samples, Legato	–	Sound Effect	Sound Effect	A	
	S-Dist Solid 2	Key-off Samples, Legato	–	Sound Effect	Sound Effect	A	
	S-Dist Solid 3	Key-off Samples, Legato	–	Sound Effect	Sound Effect	A	
	S-Dist Solid 4	Legato	–	Sound Effect	Sound Effect	A	
	S-Dist Solid 5	Key-off Samples, Legato	–	Sound Effect	Sound Effect	A	
	S-Dist Solid 6	Key-off Samples, Legato	–	Sound Effect	Sound Effect	A	
	S-Dist Vintage 1	Key-off Samples, Legato	–	Sound Effect	Sound Effect	A	
	S-Dist Vintage 2	Key-off Samples, Legato	–	Sound Effect	Sound Effect	A	
	S-Dist Crunch 1	Key-off Samples, Legato	–	Sound Effect	Sound Effect	A	
	S-Dist Crunch 2	Key-off Samples, Legato	–	Sound Effect	Sound Effect	A	
	S-Dist Finger 1		–	Grace Note	–	B	
	S-Dist Finger 2		–	Grace Note	–	B	
	TIMPANI	S-Timpani Roll	Key-off Samples	–	–	–	
		S-TimpaniRoll fp	Key-off Samples	–	–	–	
ELECTRIC BASS	S-Fingerd Bass 1	Key-off Samples	–	Sound Effect	Sound Effect	A	
	S-Fingerd Bass 2	Key-off Samples	–	Sound Effect	Sound Effect	A	
	S-Fingerd Bass 3	Key-off Samples	–	Sound Effect	Sound Effect	A	
WORLD	S-Pan Flute 1	Legato (AEM)	Bend Up, Glissando Up (Octave)	Bend Up (Fast) / Bend Down	Bend Up (Slow) / Bend Down	D	
	S-Pan Flute 2	Legato (AEM)	Bend Up, Glissando Up (Octave)	Bend Up / Bend Down	Glissando Up / Glissando Down	D	
	S-Irish Pipe 1	Legato (AEM)	Bend Up, Bend Down, Grace Note (Octave)	Bend Up / Bend Down	Grace Note / Bend Down	D	
	S-Irish Pipe 2	Legato, Grace Note (AEM)	Bend Down	Bend Up / Bend Down	Grace Note / Bend Down	D	
	S-Pi Pa	Key-off Samples	–	–	–		

ELS-02C (VA)

	Voice Name	Range	Description
VA ACOUSTIC			
1	V-Flute 1	G2 – A6	Flute with breath and other noises, which may squeak in higher registers. Setting the Touch Tone (After) higher and applying keyboard pressure can recreate flutter tonguing.
	V-Flute 2	C2 – C6	Flute suited for legato playing. Setting the User Vibrato depth to higher values has a nice effect.
	V-Ocarina	C3 – C6	Soft ocarina.
	V-Oboe	C3 – F5	Wider dynamic range with the Touch Tone effect.
	V-Clarinet	D2 – F5	Playing pianissimo creates breath noises, while playing fortissimo creates a brighter sound with slightly lower pitch.
	V-Soprano Sax	A#2 – D5	Rounder and softer soprano saxophone.
	V-Alto Sax 1	D#2 – G4	A bright alto saxophone for contemporary music. You can make the sound 'break up' as if overblowing the instrument by setting After Touch to maximum and applying pressure to the key.
	V-Alto Sax 2	C2 – E4	Alto saxophone suited for fusion music. Playing legato creates squeaky attack sounds and high After Touch settings produce an overblowing effect.
	V-Tenor Sax 1	A#2 – C4	Multi-purpose tenor saxophone. Soft in pianissimo and brighter in fortissimo.
	V-Tenor Sax 2	C1 – G4	Soft tenor saxophone suited for jazz. Playing Legato creates squeaky attack sounds.
	V-Breath Sax 1	A#2 – C4	Soft, breathy tenor saxophone suited for slow tempo music.
	V-Breath Sax 2	C2 – E4	Brighter, breathy tenor saxophone suited for jazz.
2	V-Trumpet 1	A#2 – A#4	Soft trumpet. Slides and glissandos can be created with Horizontal Touch.
	V-Trumpet 2	C2 – C5	Trumpet with characteristic attack sound. Lip slurs can be created by changing the pitch.
	V-Trumpet 3	G2 – C5	Soft trumpet. Applying slight keyboard pressure produces breath noise.
	V-Muted Trumpet	A#2 – A#4	Cup-muted trumpet.
	V-Trombone	E1 – G3	Slides and glissandos can be created with Horizontal Touch. Also, high After Touch settings produce an overblowing effect.
	V-High Trombone	C2 – C5	Brighter trombone suited for high notes.
	V-Shakuhachi	---	Higher Touch Tone (After) setting increases breath noise and also squeaks the sound.
	V-Erhu	---	Playing with softer touch produces hoarse sounds.
V-Sitar	---	Playing with harder touch squeaks the sounds.	
VA VIRTUAL			
1	V-Pan Pipe 1	E2 – G5	Setting the Touch Tone (After) higher and applying keyboard pressure can result in flutter tonguing.
	V-Pan Pipe 2	C1 – C6	Panpipe flute sound. After and Initial Touch affect the pitch and timbre.
	V-Bamboo	C1 – C6	Bamboo panpipe sound with breath noise. After Touch changes the pitch dynamically.
	V-Bottle	C1 – C6	Sound of blowing a bottle. Playing trills over a wide interval range creates a squeaky attack sound.
	V-Floboe	F2 – C7	A hybrid sound combining oboe and saxophone.
	V-Alt Kwek	C3 – C7	A hybrid sound grafting an oboe reed onto a piccolo, with a distinctive pitch change in the low registers.
	V-Tin Whistle	C2 – C7	Sound of a small flute. Playing with softer touch produces breath noise.
	V-India	---	Percussive sitar sound.
	V-East	G1 – C5	Sitar with resonance and reverberation.
	V-Zag	---	Simulation of a bowed ethnic instrument. Playing legato brings out higher octave sounds.
2	V-Asian Pluck	C1 – G6	Plucked ethnic instrument. Using Initial Touch brings out higher octave sounds.
	V-Air Reed 1	A2 – C5	A hybrid sound grafting an oboe reed onto a saxophone. High After Touch settings produce an overblowing effect.
	V-Air Reed 2	E2 – C5	A hybrid sound combining a conventional flute with panpipes.
	V-Airphone	A2 – C5	A hybrid sound grafting an oboe reed onto a soprano saxophone.
	V-Thin Reed	E2 – G5	A hybrid sound grafting a clarinet mouthpiece onto a flute. High After Touch settings produce an overblowing effect.
	V-Harmophone	G1 – G5	A hybrid sound combining a harmonica and saxophone. Depending on use of Touch Tone, both breath noise and a bright clear sound can be produced.
	V-Saxonica	G2 – G5	Harmonica sound resembling an alto saxophone. Playing with soft touch results in a high-pitched sound.
	V-Grass Reed	E2 – G5	A hybrid sound grafting a bassoon reed onto a brass wind instrument. After Touch changes the pitch.
	V-Soft Reed 1	A2 – G5	A hybrid sound grafting a clarinet mouthpiece to a brass wind instrument.
	V-Soft Reed 2	C1 – C6	A hybrid sound grafting a bassoon reed onto a soprano saxophone; includes breath noise.
V-Tropo	E1 – C6	Thick bassoon sound. After Touch changes the pitch dynamically, and applying keyboard pressure more produces wind noise.	
3	V-Buzz String	A2 – F5	Simulation of a hybrid bowed-wind instrument.
	V-Bow String	E1 – E6	Artificial synthesized strings sound.
	V-String Bow	C1 – C6	Simulation of a slow-attacked violin bowed with something other than a violin bow. Playing trills over a wide interval range creates a squeaky attack sound.
	V-Cosmosis	C1 – G5	Bowed strings. Initial Touch affects the attack sound.
	V-E.Violin	C1 – C6	Synth violin.
	V-Bowe	C1 – C5	Simulation of a hybrid bowed-saxophone sound.

Voice List

	Voice Name	Range	Description
3	V-Claviolin	G2 – G5	A hybrid sound combining a violin and wind instrument.
	V-Air Bow	C2 – G5	A bowed instrument sound with noise.
	V-Waspy Horn	C1 – G4	A hybrid sound grafting a brass wind instrument mouthpiece to a wind instrument. After Touch affects the muted condition. Lip-slide can be created with Horizontal Touch.
	V-Mizu Horn	C1 – C6	A hybrid sound combining a harmonica and trumpet.
	V-Cosmo Mute	C1 – C5	Simulation of a distorted brass wind instrument. After and Initial Touch affect the muted condition.
	V-Fago	F1 – C7	Simulated deep bassoon sound. Playing with soft touch produces breath noise with a high tone range.
VA ELECTRONIC			
1	V-Jazz Guitar	E1 – E5	Soft and warm jazz guitar sound.
	V-Picked Guitar	E1 – E5	Hard-attack guitar played with a pick.
	V-Simple Bass	---	Voice suited for bass phrases. After and Initial touch affect the resonance effect.*
	V-Bass Attack	---	Voice suited for bass phrases. Initial touch affects the muted condition.*
	V-Thumb Bass	C1 – E4	Bass sounds played with the thumb.*
	V-Fretless	C1 – C5	Fretless bass.*
	V-Saw Lead	C1 – C5	Multi-purpose lead sounds. After Touch affects the filter changes.
	V-Edge Lead	C1 – C4	Synth bass sound with a sharp attack portion. After Touch affects the filter changes.
	V-Dist Lead	G1 – C5	Distorted lead sounds. Setting the Touch Tone (After) higher and applying keyboard pressure raises the pitch.
	V-Woody Lead	C2 – G5	Lead sound with woody quality.
	V-Muted Lead	C2 – C5	Lead sound with wah-wah effect. After Touch heightens the wah-wah effect.
	V-Talken Lead	C1 – C5	Human voice-like lead sound. Setting the Touch Tone (After) higher and applying keyboard pressure allows creation of hum noise.
2	V-Mad Tube	---	Distorted synth lead with long release sound. High After Touch settings produce an overblowing effect.*
	V-Mob	---	Distorted lead sound played with pick. Setting the Touch Tone (After) higher and applying keyboard pressure raises the pitch by an octave.*
	V-Transylva	C1 – C6	Softly distorted lead sounds.*
	V-Destiny	---	Wah guitar with a sharp attack.
	V-Igneous	C1 – C4	Lead sound with full feedback effects. After Touch affects the degree of feedback.
	V-Wurli Lead	C1 – C5	Simple synth lead with a sharp attack. High After Touch settings produce an overblowing effect.
	V-Fifty Fifty	---	Analog synthesizer with simple square wave sound.
	V-Ana Wave	---	Analog synthesizer. Initial touch and the length of holding down a key changes the filter effect.
	V-Lyric Off	C1 – C6	Wind synth sound with square wave sound.
	V-Ossyncro	C1 – C6	Lead sound with dynamic pitch change.*
	V-Wahman	C1 – A3	Wah-wah lead voice with pitch change in the attack.
	V-Q. Klav	C1 – G5	Funky electric clav sound. Initial touch affects the timbre.*
3	V-SFX 1	---	Simulated hand-tapping of the open end of a pipe.
	V-SFX 2	---	Simulated scraping of a metallic plate. After Touch affects the degree of scraping.
	V-SFX 3	---	Simulated hitting of a metallic plate with a wood block. Initial Touch changes the apparent hardness of the wood block.
	V-SFX 4	---	Soft playing results in wind sounds. Applying keyboard pressure (After Touch) produces a distorted guitar sound.
	V-SFX 5	---	Jet noise. Applying keyboard pressure produces lead sound.
	V-SFX 6	---	Simulation of metallic plates colliding.
	V-SFX 7	---	Initial touch affects the resonance effect.
	V-SFX 8	---	Cry of a strange animal.
	V-SFX 9	---	Simulation of a thick and long hose.
	V-SFX 10	---	Trumpet with loop feedback sound.
	V-SFX 11	---	Initial touch produces the sound of hitting metal, and After Touch increase the noise.
	V-SFX 12	---	Initial touch produces the sounds of footsteps, and After Touch creates a windy sound.
	V-SFX 13	---	The sound of a soprano saxophone played in the distance. Playing with softer touch produces only breath noise.
	V-SFX 14	---	Lead sound with After Touch-produced pitch change.
	V-SFX 15	---	Initial touch produces the sound of metal being scraped, and After Touch creates noise.
	V-SFX 16	---	Cry/roar of an animal.

Each acoustic instrument has its own ideal note range. Keep in mind that playing outside of the range may create unexpected and unrealistic sounds. Voices that do not have a specified ideal note range ("---" is shown in the chart above) can be played in any range and result in optimum sound with stable pitch.

* When the Feet parameter is set to 8', the resulting sound is actually 16'.

Tone Generators of the ELS-02 Series

The Electone features two types of tone generators: AWM (Advanced Wave Memory) and VA (Virtual Acoustic). AWM Voices are available on all Voice Sections except for Lead Voice 2, while VA Voices (available only for the ELS-02C) are available only on the Lead Voice 2 Section.

AWM Tone Generator

AWM is a synthesis system based on sampled waves, or audio recordings of actual instruments. AWM Voices use multiple samples, so that they sound like a real instrument. This section also describes how to play the Super Articulation Voices, since you will need special settings and operations for playing these Voices.

What are Super Articulation Voices?

The Super Articulation Voices (having names beginning with the prefix “S-”) realistically recreate many of the performance techniques and characteristic sounds generated when an artist plays an instrument. As a result, you can produce superbly detailed expression such as the realistic sound of finger slides on guitar and keyboard action noise of electronic piano. Moreover, these Voices will enable you to feel the breath noise of musicians which employ performance techniques such as legato, pitch bend and glissando, as well as scat singing (“Shoo-Bee-Doo-Bah,” etc.), such as adlibbed by jazz vocalists. These expressions can be called up by simply playing the keyboard or by using the Left Footswitch.

Expression examples via the Super Articulation Voice

The following expressions can be produced by setting the parameters of ARTICULATION (page 45) on page 2 of the Voice Condition display.

Example: S-Nylon Guitar (type A)

When either of “ART.1” or “ART.2” is selected, pressing the Left Footswitch will produce body-tapping sound.

Example: S-Steel Guitar (type B)

When “ART.1” is selected, playing the keyboard with the Left Footswitch pressed will produce sound via picking harmonics.

Example: S-ShooBeeDooBah/Hmm (type C)

When “ART.1” is selected, playing the keyboard with the Left Footswitch pressed will produce a humming sound while playing the keyboard with the Left Footswitch

released will produce “Shoo,” “Bee,” “Doo,” and “Bah” alternatively.

Example: S-Alto Saxophone (type D)

When “ART.1” is selected, playing the keyboard with the Left Footswitch pressed will bend the pitch up. When “ART.2” is selected, playing the keyboard with the Left Footswitch pressed will produce glissando. When “AUTO” is set to ON, both the bend-up and glissando are produced automatically by just playing the keyboard.

VA Voices

Unlike with AWM Voices, VA synthesis applies sophisticated computer-based “physical modeling” technology to musical sound synthesis. VA Voices in this Electone offer many advantages in terms of musical performance, not just in terms of sound, but also in terms of the behavior that makes acoustic instruments so musical.

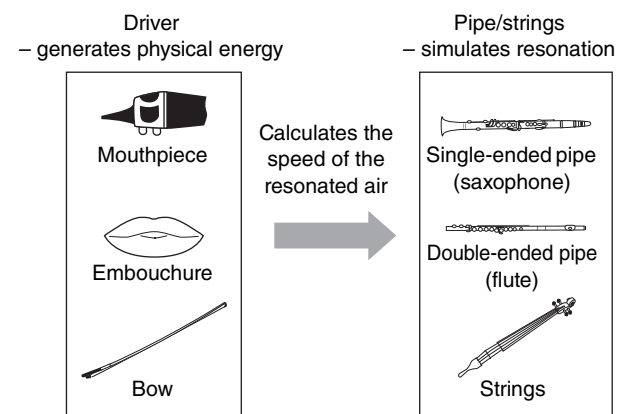

VA synthesis simulates the very complex vibrations, resonances, reflections and other acoustic phenomena that occur in an actual wind or string instrument.

Notes on VA Voices

Since the VA Voices have unique sonic characteristics and are closer in behavior to acoustic instruments than the AWM Voices, you should observe the following precautions when playing VA Voices.

- Some Voices may produce unexpected or unnatural sounds when played outside (higher or lower than) the recommended note range (pages 37 and 38).
- Pitch change may not be smooth on some Voices when Horizontal Touch is applied.
- Portamento (Lead Slide) effects may not be smooth on some Voices.
- Keep in mind that playing legato or trills may not produce any sound.

3 Organ Flutes (ELS-02C)

The ELS-02C has an Organ Flutes feature that allows you to create your own organ Voices, giving you access to an unlimited combination of organ sounds. With this function, you can recreate all of the classic organ sounds by adjusting the flute footage levels and the percussive sounds, just like on conventional organs. There are nine flute footage settings, with three additional footage settings for the attack sound.

1 Press one of the Organ Flutes buttons (UPPER or LOWER).

The lamp above the button lights and the Flute Footage Levers appear on the display. On the ELS-02, [U. ORGAN FLUTES] and [L. ORGAN FLUTES] buttons are not active (Organ Flutes does not function).

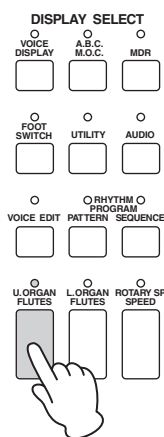

FOOTAGE Page

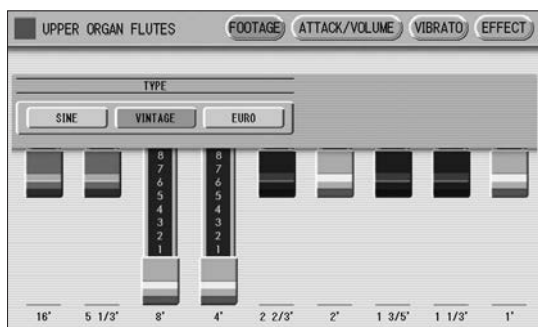

2 Select the wave type for the Organ Flute Voice.

Specifies the type of organ tone generation to be simulated.

- **SINE:** Produces a clean, clear sound.
- **VINTAGE:** Produces a gritty, slightly distorted sound.
- **EURO:** Produces the sound of the transistor electronic organ equipped with the electronic tremolo.

3 Adjust flute footage settings (over a range of 0 – 8).

The Flute footage levers can be adjusted by directly touching the display.

The Data Control dial cannot be used. Play the keyboard and listen to the changes in the sound as you adjust the footage levels.

4 Press the [ATTACK/VOLUME] button in the upper right on the display to adjust the volume and Rotary Speaker settings.

ATTACK/VOLUME Page

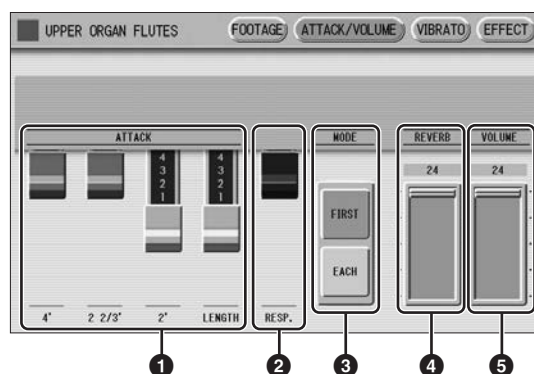

1 ATTACK

Determines the level of each volume in the percussive portion of the Voice. Footage settings are 4', 2-2/3' and 2'. The LENGTH lever determines the duration of the attack sound.

2 RESP. (Response)

Determines the overall speed of the keyboard response. Moving the lever downward makes the keyboard response slower, creating a pipe organ effect.

3 MODE

Determines which notes in a held group of notes are given an attack sound. This parameter is common to both Upper and Lower Organ Flute Voices.

- **FIRST:** Only the first note played will have attack. All other notes played while the first is held have no attack.
- **EACH:** All notes played have an attack sound.

4 REVERB

Determines the amount of reverb applied to the Organ Flute Voice. When the panel REVERB control is set to the minimum, the setting here will have no effect.

Reference page

- Reverb (page 46)

5 VOLUME

Determines the overall volume of the Organ Flute Voice. The volume balance of the individual footages is maintained. A minimum setting here produces no Organ Flute sound.

5 Press the [VIBRATO] button in the upper right on the display, then set the related parameters.

VIBRATO Page

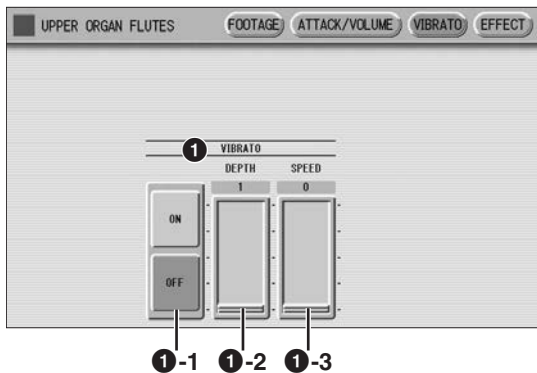

1 VIBRATO

The Vibrato function wavers the level of the Voices, making them sound warmer and more animated. This effect is applied independently to each Voice section.

1 -1 ON/OFF

Turns on or off the Vibrato effect.

1 -2 DEPTH

Determines the intensity of the Vibrato effect. Higher settings result in a more pronounced vibrato.
Range: 1 – 3

1 -3 SPEED

Determines the speed of the Vibrato effect. Higher settings increase the speed of the vibrato.
Range: 0 – 63

6 Press the [EFFECT] button at the top right of the display for the Rotary Speaker settings.

EFFECT Page

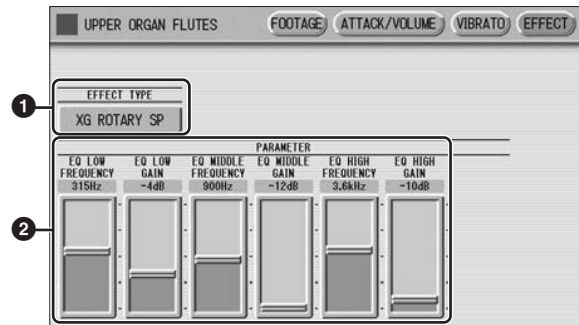

1 EFFECT TYPE

Selects the Rotary Speaker (tremolo) effect type. Press the EFFECT TYPE button to call up a list of the effect types. Select the desired type from the list.

To abort the operation, press the [CLOSE] button.

Reference pages

- Effect List (page 54)
- Rotary Speaker (page 49)

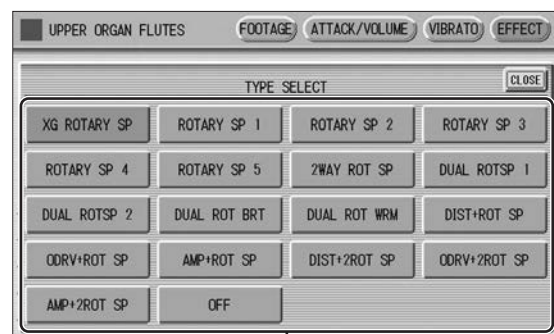
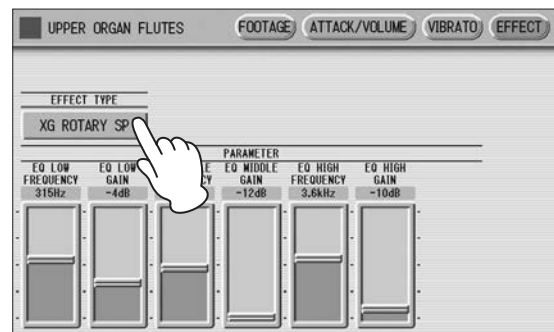

Select the desired effect type

2 Effect Parameters

Effect parameters are displayed corresponding to the selected effect type.

7 Press one of the Organ Flutes buttons (UPPER or LOWER) to cancel the Organ Flute function (the lamp above the button turns off).

4 Voice Controls and Effects

The Electone is equipped with two general kinds of functions that can be used to change the sound of the Voices: Voice Controls and Effects. Each Voice has been given certain factory-preset effect settings to best enhance its sound. However, if you wish, you can change the sound to suit your preferences by using the controls and effects described in this section. All built-in effects are digital.

The chart below shows the various Voice controls and effects for the individual Voice sections. Available functions are indicated by circles. The controls and effects are applied differently according to the different types: independently for each Voice section, independently for each keyboard, or globally for the entire system.

Controls and Effects		Reference page for changing the settings	Voice sections to which the controls/effects are applied					
			Upper Keyboard		Lead Voice	Lower Keyboard		Pedalboard
			Upper Keyboard Voice 1, 2	Organ Flute Voice	Lead Voice 1, 2	Lower Keyboard Voice 1, 2	Organ Flute Voice	Pedalboard Voice 1, 2
Selected from the display	Pan	page 43	○	—	○	○	—	○
	Touch Tone	page 43	○	—	○	○	—	○
	Pitch	page 43	○	—	○	○	—	○
	Feet	page 44	○	—	○	○	—	○
	Reverb (send level)	page 44	○	○	○	○	○	○
	Volume	page 44	○	○	○	○	○	○
	Priority	page 44	—	—	○*	—	—	—
	Poly (Pedal polyphonic mode)	page 44	—	—	—	—	—	○
	Vibrato	page 44	○	—	○	○	—	○
	Touch Vibrato	page 45	○	—	○	○	—	○
	Lead Slide	page 45	—	—	○	—	—	—
	Articulation Auto	page 45	○	—	○**	○	—	○
	Articulation Foot SW Left	page 45	○	—	○**	○	—	○
	Transpose	page 46	○	—	○	○	—	○
	Tune	page 46	○	—	○	○	—	○
Effect (1/2)	page 45	○	○ (Rotary Speaker only)	○	○	○ (Rotary Speaker only)	○	
Selected from the panel	Reverb	page 46	○					
	Sustain	page 48	○	—	○	○	—	○
	Brilliance	page 48	○	—	○	○	—	○
	Rotary Speaker	page 49	○					

*Priority is applied only for Lead Voice 2.

** Not available for VA Voices.

NOTE

Vibrato, Touch Vibrato, Slide, Articulation Auto, Articulation Foot SW Left and Sustain may not be available on some Voices.

Settings Selected from the Voice Condition Display

Choose a Voice on the panel, then press the same button on the panel again (or press the name of the selected Voice in the display). The Voice Condition display appears.

Voice Condition display for each Voice has five pages that can be switched by pressing [1] – [5] buttons at the top right of the display.

Voice Condition [Page 1]

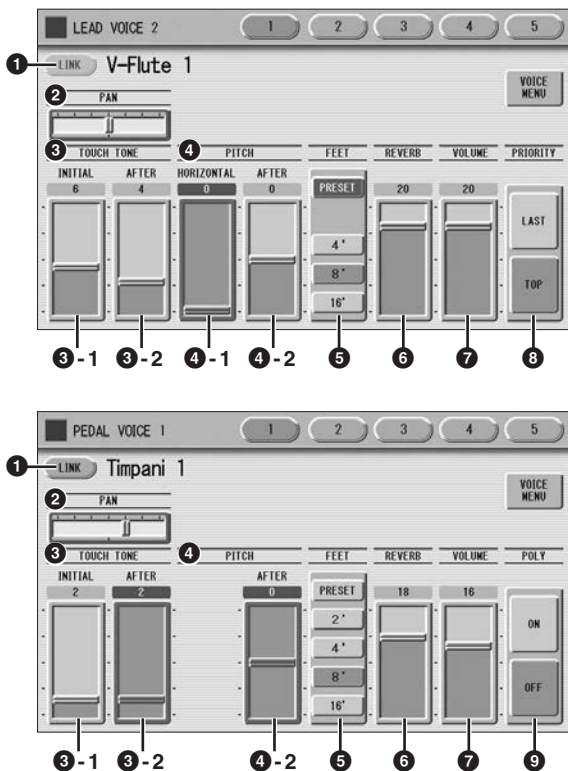

In this display, you can adjust the basic Voice controls, including panning, touch tone and volume. The displays of the various Voice sections have slight differences in their functions.

1 Voice Link

Lets you register the settings on the Voice Condition display (except for Volume and Brilliance) to the Voice Link Category as a Voice. The registered Voice can be selected from the “Voice Link” category on the display called up via the User buttons of all the Voice Sections. For detailed instructions, see page 50.

2 PAN

Determines the position of the Voice in the stereo image. Seven pan positions are available.

3 TOUCH TONE

The Touch Tone function gives you expressive control over the volume and timbre of a Voice. All Voices are provided with this expressive function, making it possible to perfectly reproduce the subtle dynamic and tonal changes of actual instruments.

Two types of keyboard touch affect this function: Initial Touch and After Touch.

3 -1 INITIAL touch

Controls volume and timbre according to the velocity at which you play the keys. The harder you play the keys, the greater the volume and the brighter the timbre will become.

Higher settings make the change wider. Minimum setting produces no effect.

Range: 0 – 14

NOTE

Initial Touch may not be effective on some organ Voices.

3 -2 AFTER touch

Controls volume and timbre according to the pressure you apply to the keys after playing them.

The harder you press down on the keys, the greater the volume and the brighter the timbre will become. Higher settings make the change wider. Minimum setting produces no effect.

Range: 0 – 14

NOTE

- On the ELS-02, After Touch is not applied to the Pedal Voices.
- After Touch has no effect on percussive Voices (such as piano or vibraphone), percussion sounds, or some organ Voices.

4 PITCH

Controls pitch according to the playing style of Horizontal Touch or After Touch. On some Voices in the Lead Voice 2 section, not only pitch but also timbre may be affected.

4 -1 HORIZONTAL touch (ELS-02C)

Controls the pitch by holding down the key and moving it laterally (wiggling your finger from side to side). The faster you move the key laterally, the faster and greater the pitch change becomes, within a range of +/- one octave. You can use this function in combination with Touch Tone described above to add expressiveness to your performance.

Higher settings result in a wider pitch change. The minimum setting produces no effect. This function is not available on the Pedalboard.

Range: 0 – 14

NOTE

Parameters that are available only on the ELS-02C are indicated by a dark frame and background in their display controls.

4 -2 AFTER touch

Controls the pitch according to the pressure you apply to the keys after playing them.

The minimum setting produces no effect at all. Higher (positive) settings make the pitch higher according to the pressure and lower (negative) settings make the pitch lower. The extreme settings of +14 and -14 result in the widest pitch change.

Range: -14 – +14

5 FEET

Determines the octave setting of the Voice, letting you use the Voice over a wide register. There are three settings: 4', 8' and 16' (4' is highest and 16' is lowest). A 2' setting is added to the Pedal Voice sections. PRESET is the original (factory) setting.

6 REVERB

Determines the amount of reverb applied to each Voice section. When the panel REVERB control is set to the minimum, the setting here will have no effect. See page 46 for details.

7 VOLUME

Fine adjustment of the Voice volume. See page 26 for more information.

8 PRIORITY (only for the Lead Voice 2)

Determines the mode of Lead Voice 2, Last or Top.

- **LAST:** Only the last played key is sounded when two or more keys are played simultaneously.
- **TOP:** Only the highest note is sounded when two or more keys are played simultaneously. When the Solo mode is on, Lead Voice 2 sounds according to Last mode, regardless of the setting made here.

Reference page

- Solo function (page 27)

9 POLY (only for Pedal Voices)

Allows you to switch the pedal polyphonic mode on or off. Setting POLY to on switches the normally monophonic pedal Voices to polyphonic play. This makes it possible to play the Pedalboard in various expressive ways, such as playing legato or playing intervals and chords.

Keep in mind that you cannot exceed the total maximum polyphony: 14 notes for all sections, Upper, Lower and Pedal.

Voice Condition [Page 2]

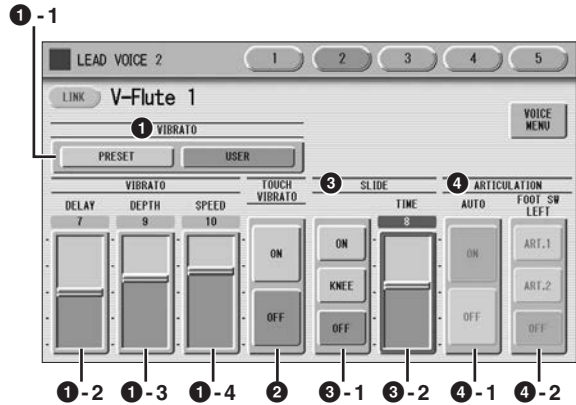

The items included in this page differ between the Lead Voice sections and the other sections. SLIDE (3) only applies to Lead Voice 1 and 2.

1 VIBRATO

The Vibrato function wavers the level of the Voices, making them sound warmer and more animated. This effect is applied independently to each Voice section. For some Voices, vibrato may not be effective at all or the effect may not sound as expected.

1 -1 PRESET/USER

Selecting PRESET calls up the original (factory) vibrato settings for the Voice.

When PRESET is selected, DELAY, DEPTH and SPEED parameters cannot be edited.

Selecting USER lets you adjust the vibrato settings for yourself.

Vibrato Control

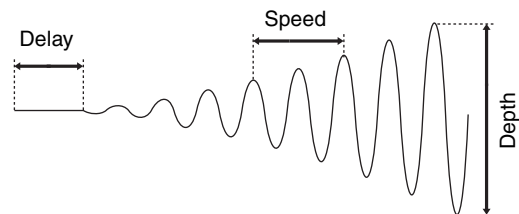

1 -2 DELAY

Determines the amount of time that elapses between the playing of a key and the start of the vibrato effect. Higher settings increase the delay of the vibrato onset.

Range: 0 – 14

1 -3 DEPTH

Determines the intensity of the vibrato effect. Higher settings result in a more pronounced vibrato. The minimum setting cancels the vibrato effect.

Range: 0 – 14

1 -4 SPEED

Determines the speed of the vibrato effect. Higher settings increase the speed of the vibrato.

Range: 0 – 14

2 TOUCH VIBRATO

Turns the Touch Vibrato function on or off. Setting Touch Vibrato to on lets you apply vibrato to individual notes as you play them by after touch. The harder you press down the key, the greater the vibrato will be. When Touch Vibrato is off, vibrato depth cannot be controlled, no matter how hard you press the keys.

NOTE

Touch Vibrato is not applied to the Pedal Voices of the ELS-02.

3 SLIDE (only for Lead Voices)

Applies a portamento effect to notes played in legato. The Slide function is effective within a one-octave range for Lead Voices. Slide has no effect when playing notes beyond a one-octave range.

Reference page

- Controlling Lead Slide (with Knee Lever); (page 182)

3 -1 ON/KNEE/OFF

On/Off switch and knee lever selector for the Slide effect.

3 -2 TIME

Determines the speed of the slide or portamento effect. Higher settings makes the slide speed slower.

Range: 0 – 14

NOTE

The parameters here are not available when a Super Articulation Voice is selected.

4 ARTICULATION

The settings here, available only for Super Articulation Voices, produce effects (such as pitch bend and glissando) which are characteristic of the corresponding acoustic instrument, making your keyboard performance more realistic.

4 -1 AUTO

Setting this to ON will apply various effects such as pitch bend and glissando to your keyboard performance.

4 -2 FOOT SW LEFT

Determines the effect produced via the Left Footswitch: ART.1, ART.2 and OFF.

NOTE

For information about what effect is produced by setting AUTO, ART.1 and ART.2 to ON, see "Super Articulation Voice Supplementary List" on pages 34 – 36. As listed on these pages, AUTO, ART.1 and ART.2 are not available for some Voices.

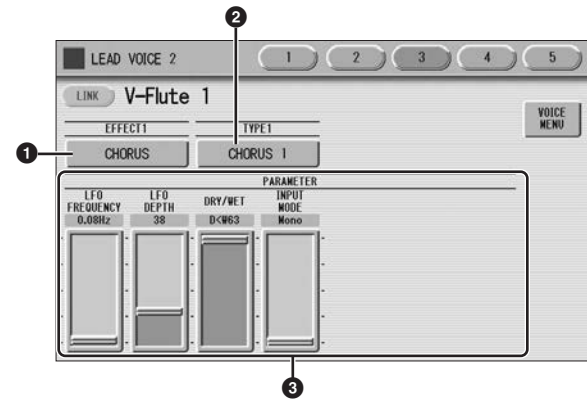
Voice Condition [Pages 3 and 4]

You can edit the effect parameters from these two displays. Both displays have the same contents. You can select two effects for each Voice section with these displays (Voice Condition Pages 3 and 4).

1 EFFECT 1 (Page 3)/EFFECT 2 (Page 4)

Selects the effect category. Pressing the EFFECT button on the display calls up the effect category list. Select the desired effect category from the list.

To abort the operation, press the [CLOSE] button.

Reference page

- Effect List (page 54)

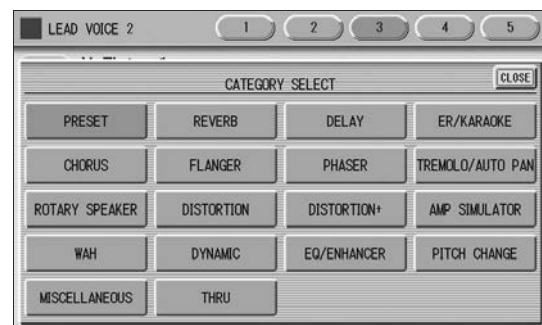

By selecting [PRESET] in the list, the original (factory) effect category for the selected Voice is automatically set. Selecting [THRU] bypasses the effect (no effect is added to the selected Voice).

2 TYPE 1 (Page 3)/ TYPE 2 (Page 4)

Determines the type of the effect. Pressing the TYPE button on the display calls up the effect type list, corresponding to the selected effect category. Select the desired effect type from the list.

To abort the operation, press the [CLOSE] button.

If you have selected the [PRESET] category, the effect type cannot be edited.

After changing the effect type, the effect parameter below is automatically changed corresponding to the selected effect type.

③ Effect Parameters

Effect parameters are displayed corresponding to the selected effect type.

Voice Condition [Page 5]

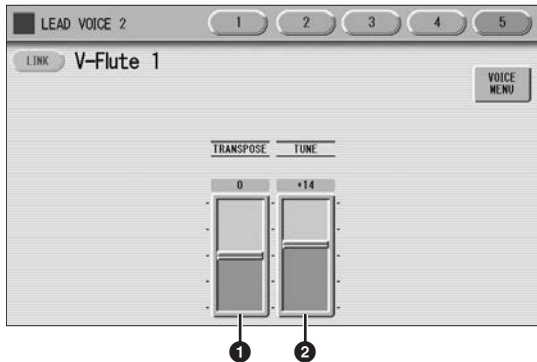

① TRANSPOSE

Changes the pitch in semitones for each Voice section. Range is from -6 to +6.

Reference page

- Transpose (for entire instrument); (page 184)

② TUNE

Determines the fine pitch settings (detune) for each Voice section, producing a richer sound. Each step represents a 1-cent change in pitch.

Range: -64 – +63

Reference page

- Pitch (for entire instrument); (page 184)

Selecting from the Panel

The Reverb, Sustain, Brilliance and Rotary Speaker displays are called up by pressing the respective buttons on the panel.

Reverb

Reverb adds an echo-like effect to the sound, giving the impression of a performance in a large room or concert hall. You can adjust the reverb volume for each Voice sections, or adjust the reverb volume for rhythm and accompaniment separately.

To adjust the reverb effect and call up the Reverb pages:

Press one of the REVERB buttons, located to the left of the panel, to set the Reverb effect. The Reverb display appears.

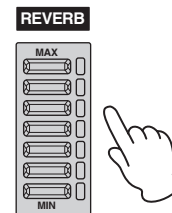

The Reverb display consists of four pages.

REVERB [Page 1]



DEPTH:

Fine adjustment of the depth of reverberation or the level of the reflected sounds. Coarse reverb depth settings are made with the panel REVERB buttons. The REVERB buttons let you make coarse adjustment in seven settings to the reverb depth while the slider gives you fine control. When this parameter or the panel REVERB control is set to the minimum, the settings in the pages that follow have no effect.

Range: 0 – 24

NOTE

Depending on the reverb depth value (set by the slider), two adjacent REVERB button lamps may be lit at the same time, indicating an intermediate position.

REVERB [Page 2]

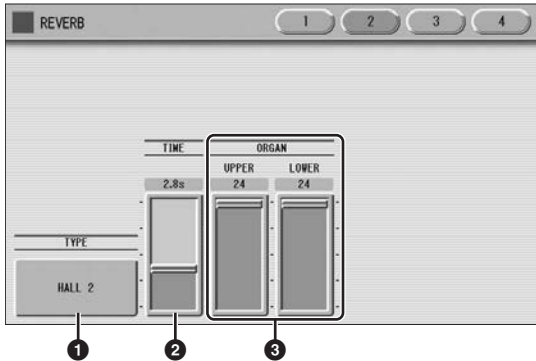

1 TYPE

Determines the reverb type for each of the Voice sections and the Organ Flute Voice.

Several types can be selected: Room, Hall, Stage, and so on.

Pressing the TYPE button on the display calls up the Reverb Type list.

Reference page

- Effect List (page 54)

Press the number buttons to change the display pages.

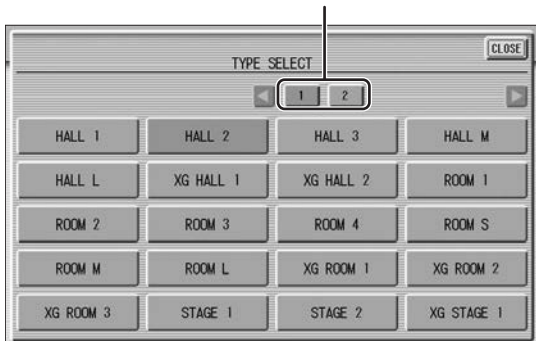

The list contains many reverb types, more than can fit on one display page. To change the display pages, press the appropriate number buttons [1] or [2] in the display.

Select the desired reverb type from the list.

To abort the operation, press the [CLOSE] button.

After changing the reverb type, the TIME parameter below is automatically changed corresponding to the selected reverb type.

2 TIME

Determines the reverb length for each of the Voice sections and the Organ Flute Voice.

Higher settings make the reverb effect longer.

Range: 0.3s – 30.0s

3 ORGAN (only for the ELS-02C)

Determines the amount of reverb applied to the Organ Flute Voice. This parameter corresponds to the REVERB slider contained in the ATTACK/VOLUME Page of the Organ Flute display.

On the ELS-02, this slider is not displayed.

Range: 0 – 24

Reference page

- Organ Flutes (page 40)

REVERB [Page 3]

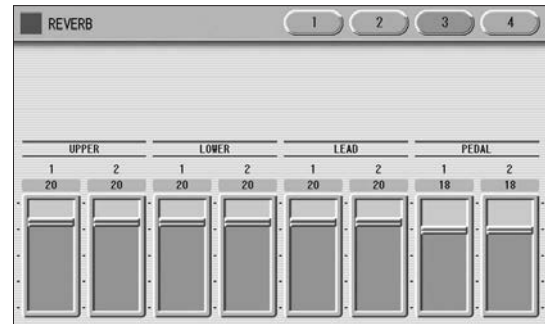

Determines the amount of reverb effect applied to each Voice section.

Each slider corresponds to the REVERB slider in Voice Condition Page 1 of the respective Voices.

Range: 0 – 24

REVERB [Page 4]

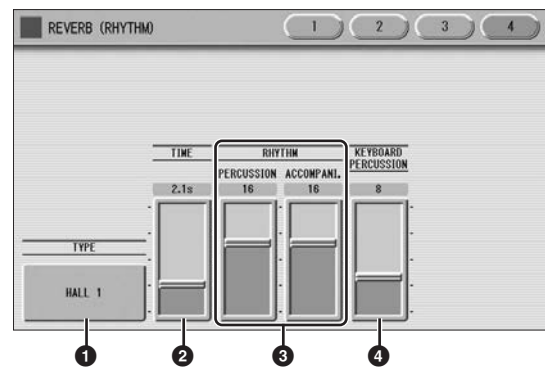

1 TYPE

Determines the reverb type for rhythm, accompaniment, keyboard percussion, and microphone signal.

Reference page

- Connecting a Microphone or Guitar (page 189)

2 TIME

Determines the length of reverb applied to the rhythm, accompaniment, keyboard percussion, and microphone signal.

Range: 0.3s – 30.0s

3 RHYTHM

Determines the amount of reverb applied to the rhythm (with PERCUSSION slider) and accompaniment (with ACCOMPANI. slider). Each slider corresponds to the REVERB slider in the Rhythm Condition display.

Range: 0 – 24

 **Reference page**

- Changing the rhythm reverb (page 60)

4 KEYBOARD PERCUSSION

Determines the amount of reverb applied to the Keyboard Percussion.

Range: 0 – 24

 **Reference page**

- Keyboard Percussion (page 68)

Sustain

The sustain effect, selectable for each Voice section, causes Voices to gradually fade out when the keys are released. The sustain on/off and sustain length settings are independent for each keyboard, providing maximum expressive control.

The Knee Lever can also be used to switch the sustain on/off. Sustain cannot be applied to the Lead Voices.

 **Reference page**

- Knee Lever (page 180)

To add sustain to the Voices and call up the Sustain Length display:

Press one of the SUSTAIN buttons, located to the left of the panel, to set the sustain. The SUSTAIN LENGTH display appears.

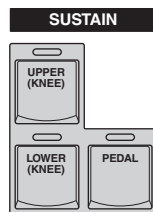

The lamp of the button lights up to indicate that sustain is on. Press the button again to turn sustain off and the lamp turns off. When the lamp is off, sustain does not affect the corresponding keyboard.

Remember to check whether the sustain button lamps are on or off before you start to play.

SUSTAIN LENGTH display

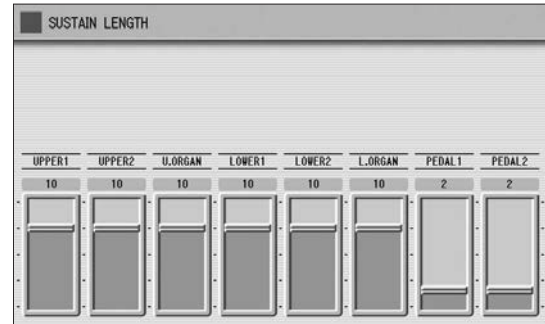

To adjust the sustain length value, use the display slider. If you set the highest value (HOLD), some Voices such as organ or synth will sound continuously even when the keys are released.

Range: 0 – 12, HOLD

NOTE

- If you change the Voice when the sustain length is set to HOLD and the keys are released, the Voice only changes after you play another key.
- When the sustain length is set to HOLD, previously played note(s) may be cut off by subsequently played notes.
- The minimum setting results in no sustain. Turning sustain off automatically resets the sustain length to be the default setting.
- Only "HOLD" is available for the Voices listed below. No effect is produced when a value of 0 – 12 is set.

S-Violin 1/2	S-Tenor Sax 1/2/3
S-Trumpet 1/2	S-TenorSax Growl
S-Trombone	S-Soprano Sax
S-Flute	S-SprnoSax Growl
S-Flute Flutter	S-Harmonica
S-Clarinet 1/2	S-BluesHarp
S-Alto Sax	S-Pan Flute 1/2
S-Alto Sax Growl	S-Irish Pipe 1/2
- If the pedal Voice using a Super Articulation Voice (excepting S-Piano 1/2) is played when the sustain length is set to HOLD, the Voice sound which is played earlier continues to sound without being cut off, regardless of whether Pedal Poly (page 44) is set to on or off.

Brilliance

Adjustment of the Voice tone, brighter or mellower.

Press the BRILLIANCE buttons of each Voice section on the panel to set the desired brilliance for each Voice.

The buttons have seven brilliance settings.

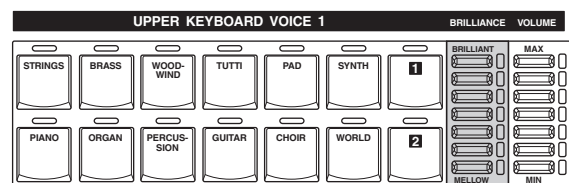

Rotary Speaker

Rotary Speaker recreates the rich, swirling sound of the popular rotating speaker effect. The Rotary Speaker effect can be switched in real time as you play, with either the front panel button or the Left Footswitch (when properly set for Footswitch operation). Keep in mind that the Rotary Speaker effect CANNOT be turned on only by turning on the [ROTARY SP SPEED] button. To properly use the Rotary Speaker effect, follow the procedure below.

1 Select the Rotary Speaker effect from the desired Voice.

When you want to set Rotary Speaker to one of the Voice sections, you can select the effect category of Rotary Speaker in the Voice Condition display Page 3 or 4. See page 45 for details.

Select "Rotary Speaker" here.

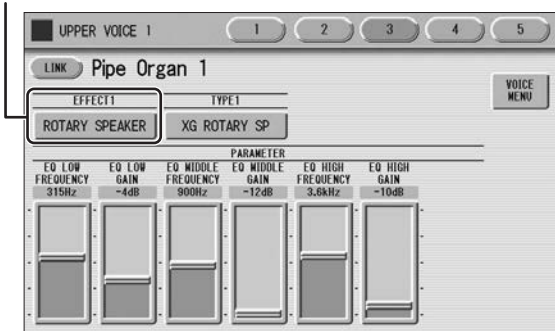

When you want to set Rotary Speaker for the Organ Flute Voice, select the effect type in the EFFECT Page. See page 41 for details.

Select an effect type other than [OFF].

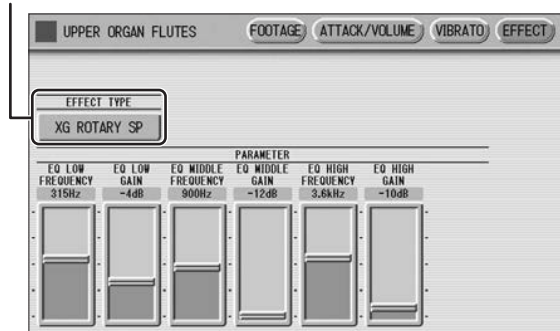

2 Adjust the rotating speed and mode of the Rotary Speaker.

Press the [ROTARY SP SPEED] button on the panel. The ROTARY SPEAKER display appears. The settings in this display are common to all Voice sections.

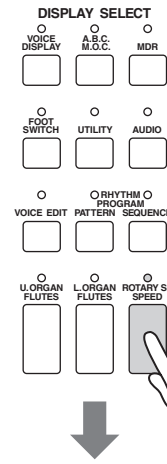

ROTARY SPEAKER display

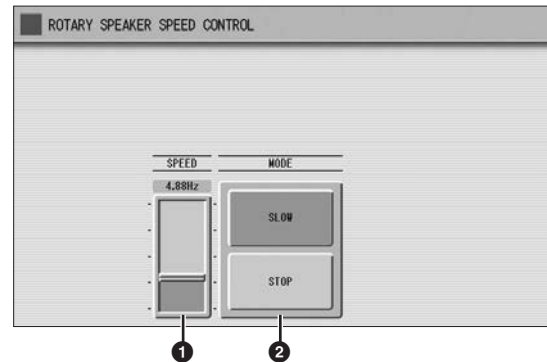

1 SPEED

Determines the speed of the speaker rotation.
Range: 2.69Hz – 39.7Hz

2 MODE

Determines the slow/stop mode when [ROTARY SP SPEED] button is off. If [SLOW] is selected, a slow chorus effect is applied when you turn off the button on the panel. If [STOP] is selected, the Rotary Speaker effect turns off when you turn off the button on the panel.

Once the Rotary Speaker effect has been turned on and set, you can control the effect in real time from the panel or from the Left Footswitch.

3 Control the Rotary Speaker effect from the panel or from the Left Footswitch.

You can control Rotary Speaker on/off not only from the panel but also the Left Footswitch, if the Footswitch has been properly assigned. See page 180 for details.

Using Voice Link

Registering a Voice with the settings on the Voice Condition display to Voice Link

You can register the current Voice with the current settings (except for Volume and Brilliance) on the Voice Condition display to the Voice Link category as a Voice.

1 Make the desired settings on the Voice Condition display.

Here, set the FEET to "4."

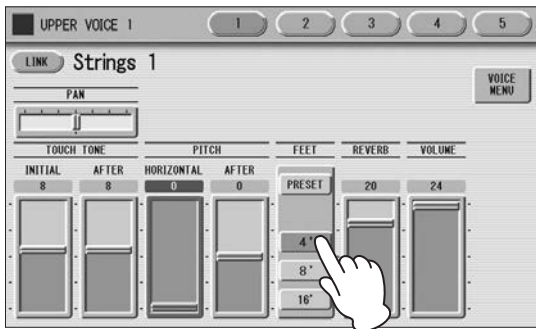

2 At the left top on the display, press the [LINK] button.

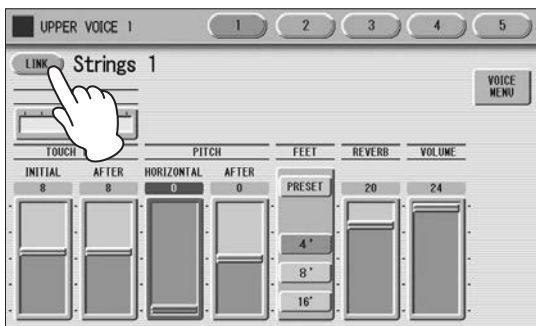

3 Press the [REGISTER] button on the display.

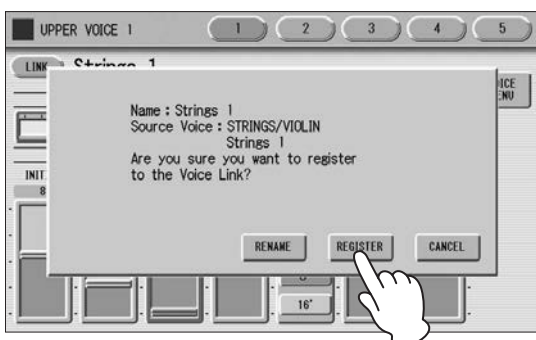

The settings will be registered, then the Voice Link indication (chain link icon) appears at right of the Voice name on the display.

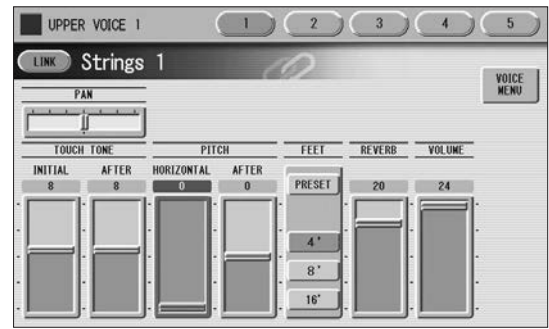

This Voice Link indication in the Voice name will be shown also on the Voice Display, enabling you to confirm which Voice Section uses Voice Link.

This chain link icon appears when the corresponding Voice is registered as a Voice Link.

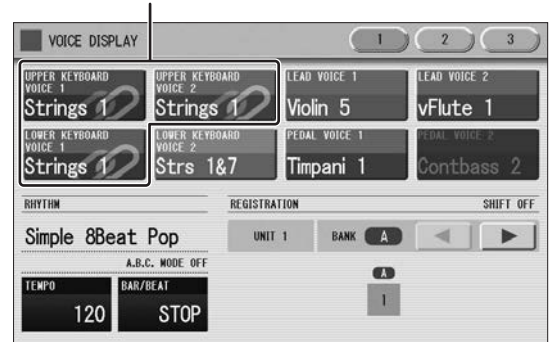

NOTE

When the same Voice has already been registered to Voice Link, the [REGISTER] button in step 3 is grayed out and cannot be used. If this occurs, press the [RENAME] button, assign a different name to the current Voice, then register the Voice to Voice Link again. For details, see page 52. If you want to overwrite the current Voice with the same Voice name to Voice Link, see page 51.

Selecting a Voice registered to Voice Link

1 Press a User button in the desired Voice Section.

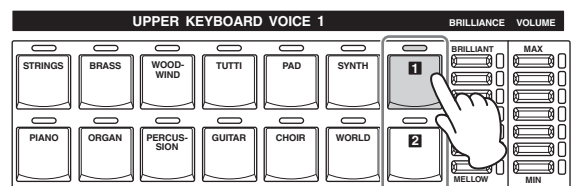

User buttons

- 2 Press the **Voice Link Category** from the **Voice Categories** at the right top on the display, then press the desired **Voice name**, for example **“Strings 2”** here.



Editing the Voice registered to Voice Link

If you change the settings on the Voice Condition display of the Voice in Voice Link, storing to the Registration Memory will apply the changed new settings to all Registrations which use the same Voice in Voice Link.

- 1 Select a Voice in Voice Link, call up the **Voice Condition** display, then make the desired settings.
- 2 Store the panel settings to a **Registration Memory** button by following the instructions on page 95.

NOTE

- When you save the Song or Unit next time, the settings of the Voice Condition display will be applied to all the Units.
- When you want to change the Voice Condition settings of the Voice already registered to Voice Link without affecting the sound of another Voice Section and another Registration Memory number, you should release the Voice from Voice Link (see next topic), then register the settings to Voice Link with a different Voice name (page 52).

Releasing the current Voice settings from Voice Link

When you want to change the Voice Condition settings of the Voice already registered to Voice Link without affecting the sound of another Voice Section and another Registration Memory number, you should release the Voice from Voice Link, then register the settings to Voice Link with a different Voice name by following the instructions on page 52.

- 1 From the **Voice Link Category** display, select the **Voice** to be released from **Voice Link**.

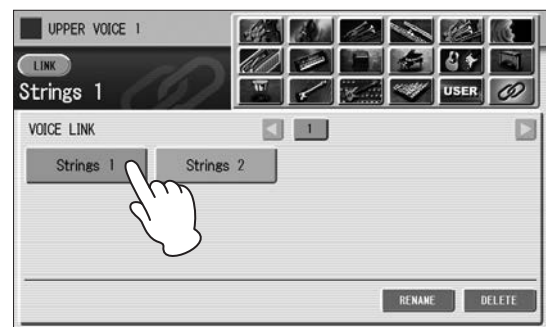

- 2 Press the **[LINK]** button on the display.



- 3 Press the **[OK]** button.



The current Voice is now released from Voice Link.

Registering a Voice to Voice Link with a different Voice name

This section covers how to register the current Voice to Voice Link with a different Voice name.

- 1 After pressing the [LINK] button on the display, press the [RENAME] button on the dialog window.



- 2 Change the Voice name, then press the [OK] button.



Reference page

- Changing the Song Name (page 116)

- 3 Press the [REGISTER] button on the dialog window.



The settings will be registered, then the Voice Link indication appears at right of the Voice name on the display.

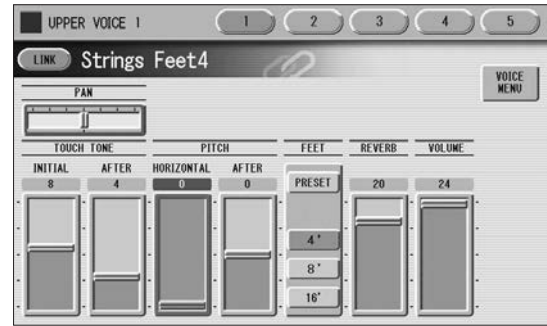

Deleting a Voice from Voice Link

Since there is a limit to the number of Voices that can be registered to Voice Link, you may want to delete unnecessary Voices from Voice Link if the amount of registered Voices comes close to 80.

The delete operation can be executed in any Voice Section.

- 1 From the Voice menu in the Voice Link category, select a Voice to be deleted.



- 2 Press the [DELETE] button on the display.



3 Press the [OK] button on the dialog window.

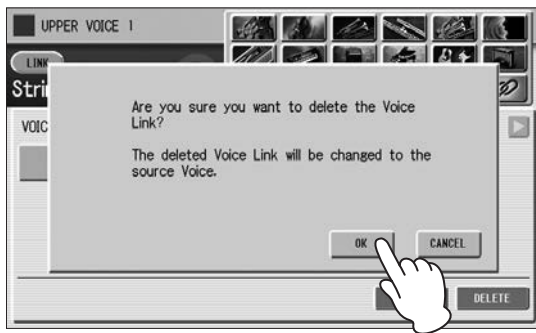

The selected Voice is now deleted from Voice Link.

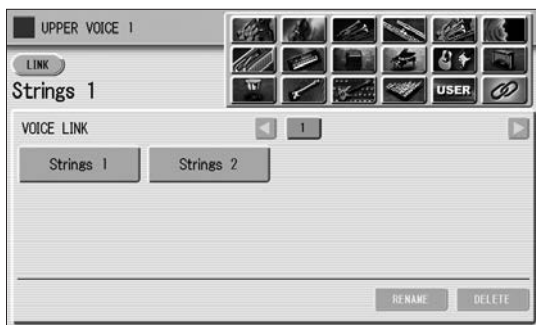

When you press the Registration Number button containing data using a Voice registered to Voice Link, the corresponding Voice and its settings on the Voice Condition display will be called up from its original Voice Category (not from Voice Link). This means that the Voice will sound the same as when the Voice settings were stored to the Registration Memory, regardless of changes made in the operation here.

Effect List

REVERB				
HALL 1	HALL 2	HALL 3	HALL M	HALL L
XG HALL 1	XG HALL 2	ROOM 1	ROOM 2	ROOM 3
ROOM 4	ROOM S	ROOM M	ROOM L	XG ROOM 1
XG ROOM 2	XG ROOM 3	STAGE 1	STAGE 2	XG STAGE 1
XG STAGE 2	PLATE 1	PLATE 2	XG PLATE	GM PLATE
WHITE ROOM	ATMO HALL	ACOSTIC ROOM	DRUMS ROOM	PERC ROOM
TUNNEL	CANYON	BASEMENT		
DELAY				
DELAY LCR	XG DLY LCR	DELAY LR	ECHO	CROSS DELAY1
CROSS DELAY2	TEMPO DELAY1	TEMPO DELAY2	TEMPO ECHO	TEMPO CROSS1
TEMPO CROSS2	TEMPO CROSS3	TEMPO CROSS4		
ER/KARAOKE				
ER 1	ER 2	GATE REVERB1	GATE REVERB2	REVERS GATE
KARAOKE 1	KARAOKE 2	KARAOKE 3		
CHORUS				
CHORUS 1	CHORUS 2	XG CHORUS 1	XG CHORUS 2	XG CHORUS 3
XG CHORUS 4	GM CHORUS 1	GM CHORUS 2	GM CHORUS 3	GM CHORUS 4
FB CHORUS	CHORUS FAST	CHORUS LITE	AMB CHORUS	CELESTE 1
CELESTE 2	CELESTE 3	CELESTE 4	AMB CELESTE	SYMPHONIC
XG SYMPHONIC	AMB SYMPHO	ENS DETUNE 1	ENS DETUNE 2	
FLANGER				
FLANGER 1	FLANGER 2	XG FLANGER 1	XG FLANGER 2	XG FLANGER 3
GM FLANGER	V_FLANGER	TEMP FLANGER	DYNA FLANGER	VIN FLANGER1
VIN FLANGER2	AMB FLANGER			
PHASER				
PHASER 1	PHASER 2	PHASER 3	EP PHASER 1	EP PHASER 2
EP PHASER 3	TEMP PHASER1	TEMP PHASER2	DYNA PHASER	VIN PHASER 1
VIN PHASER 2	VIN PHSR ST1	VIN PHSR ST2	VIN PHSR ST3	VIN PHSR ST4
TREMOLO/AUTO PAN				
TREMOLO 1	TREMOLO 2	XG TREMOLO	EP TREMOLO	GT TREMOLO 1
GT TREMOLO 2	ORG TREMOLO	VIBE VIBRATE	T_TREMOLO	AUTO PAN
XG AT PAN 1	XG AT PAN 2	EP AUTO PAN	T_AUTO PAN 1	T_AUTO PAN 2
ROTARY SPEAKER				
XG ROTARY SP	ROTARY SP 1	ROTARY SP 2	ROTARY SP 3	ROTARY SP 4
ROTARY SP 5	2WAY ROT SP	DUAL ROTSP 1	DUAL ROTSP 2	DUAL ROT BRT
DUAL ROT WRM	DIST+ROT SP	ODRV+ROT SP	AMP+ROT SP	DIST+2ROT SP
ODRV+2ROT SP	AMP+2ROT SP			
DISTORTION				
DIST HARD 1	DIST HARD 2	DIST SOFT 1	DIST SOFT 2	ST DIST HARD
ST DIST SOFT	OVERDRIVE	ST OVERDRIVE	XG DIST	XG ST DIST
V_DIST HARD	V_DIST SOFT	COMP+DIST	XG CMP+DIST	V_DIST WARM
V_DIST CLS H	V_DIST CLS S	V_DIST METAL	V_DIST CRUNC	V_DIST BLUES
V_DIST EDGY	V_DIST SOLID	V_DIST CLN 1	V_DIST CLN 2	V_DIST TWIN
V_DIST ROCA	V_DST JZ CLN	V_DST FUSION		

DISTORTION+				
DIST+DELAY	ODRV+DELAY	XG DIST+DLY	XG ODRV+DLY	CMP+DIST+DLY
CMP+ODRV+DLY	XG CMP+DT+DL	XG CMP+OD+DL	V_DIST H+DLY	V_DIST S+DLY
DIST+T DLY	ODRV+T DLY	CMP+DST+TDLY	CMP+OD+TDLY1	CMP+OD+TDLY2
CMP+OD+TDLY3	CMP+OD+TDLY4	CMP+OD+TDLY5	CMP+OD+TDLY6	VDST H+TDLY1
VDST H+TDLY2	VDST S+TDLY1	VDST S+TDLY2		
AMP SIMULATOR				
AMP SIM	XG AMP SIM	ST AMP SIM 1	ST AMP SIM 2	ST AMP SIM 3
ST AMP SIM 4	ST AMP SIM 5	XG ST AMP	ST AMP SOLID	ST AMP CRUNC
ST AMP BLUES	ST AMP CLEAN	ST AMP HARP	SML ST DIST	SML ST OVRDR
SML ST VINTG	SML ST HEAVY	B CMB CLASC	B CMB TOPBST	B CMB CUSTOM
B CMB HEAVY	B LGND BLUES	B LGND HVY1	B LGND HVY2	B LGND CLEAN
B LGND D CLN	US CMB TWIN	USCMB RCH CL	USCMB THN CL	USCMB CRUNCH
JZ CMB BASIC	JZ CMB WARM	US HI GN DTY	US HI GN RIF	US HIGN BURN
US HIGN SOLO	B LD DIRTY	B LD DRIVE	B LD GAINER	B LD HARD
WAH				
AUTO WAH	XG AUTO WAH	V_AUTO WAH	TOUCH WAH 1	TOUCH WAH 2
TOUCH WAH 3	V_TOUCH WAH	AT WAH+DIST	XG AT WH+DST	AT WH+DST HD
AT WH+DST HV	AT WH+DST LT	AT WAH+ODRV	XG AT WAH+OD	AT WH+OD HD
AT WH+OD HV	AT WH+OD LT	TC WAH+DIST	XG TC WH+DST	TC WH+DST HD
TC WH+DST HV	TC WH+DST LT	TC WAH+ODRV	XG TC WAH+OD	TC WAH+OD HD
TC WAH+OD HV	TC WAH+OD LT	CLAVI TC WAH	EP TOUCH WAH	WAH+DST+TDLY
WAH+OD+TDLY1	WAH+OD+TDLY2	WAH+DIST+DLY	XG WH+DST+DL	WAH+ODRV+DLY
XG WH+OD+DLY	TEMPO AT WAH	T_A.WH+DST	T_A.WH+DSTHD	T_A.WH+DSTHV
T_A.WH+DSTLT	T_A.WH+ODRV	T_A.WH+OD HD	T_A.WH+OD HV	T_A.WH+OD LT
DYNAMIC				
M BAND COMP	COMPRESSOR	COMP MED	COMP HEAVY	COMP MELODY
COMP BASS	V_COMPRESSOR	NOISE GATE		
EQ/ENHANCER				
ST 2BAND EQ	ST 3BAND EQ	XG 3BAND EQ	EQ DISCO	EQ TEL
HM ENHANCER	XG HM ENHNCE			
PITCH CHANGE				
PITCH CHANGE	XG PCH CHG 1	XG PCH CHG 2		
MISCELLANEOUS				
AMBIENCE	IMPULSE EXP	RESONATOR	VOICE CANCEL	TALKING MOD
LO-FI	DYNA FILTER	DYNA RINGMOD	RING MOD	ISOLATOR
LOOP FX1	LOOP FX2	LO-FI DRUM1	LO-FI DRUM2	LO-FI DRUM3
LO-FI DRUM4	DAMPER RESO			
THRU				
THRU				

NOTE

Damper Resonance (DAMPER RESO) can be applied only when Sustain is turned on. For information on turning Sustain on, see page 48.

5 Rhythm/Keyboard Percussion

This Electone features more than 600 different real rhythms featuring actual drum and percussion sampled sounds. Automatic Accompaniment functions are used with the rhythms, providing appropriate and completely automatic accompaniment to match the style of the selected rhythm. Moreover, the Electone has a Keyboard Percussion feature that allows you to play drum and percussion sounds from the Upper, Lower keyboard and Pedalboard.

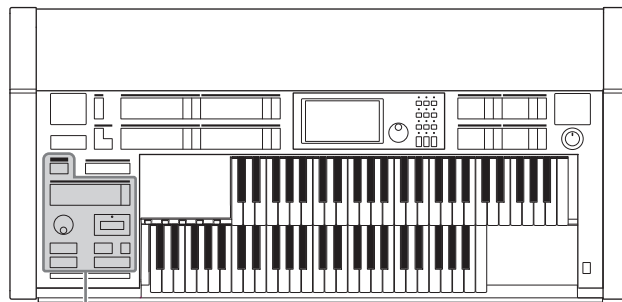
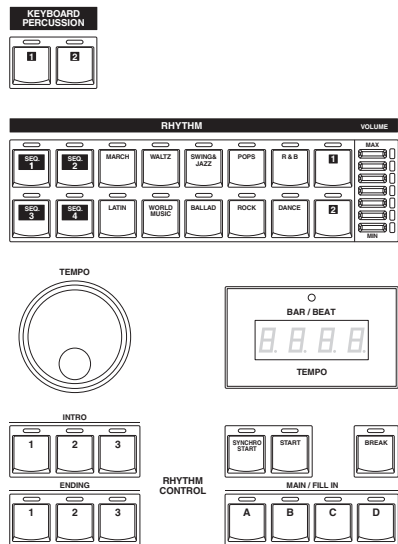

Rhythm/Keyboard Percussion

Selecting Rhythms with the Rhythm Buttons

You can instantly select a rhythm from more than 600 rhythms with the ten rhythm buttons on the front panel.

Selecting a rhythm

In the explanation below, 16Beat 1 in the POPS category is selected as an example.

- 1 Press one of the Rhythm buttons in the RHYTHM section on the front panel (for example, the [POPS] button).

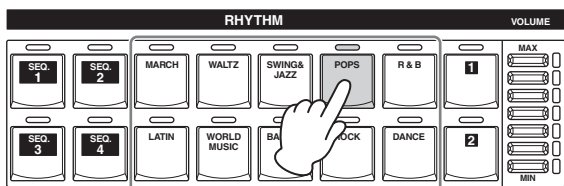

Rhythm buttons

The relevant Rhythm Menu is displayed.

- 2 Select the desired rhythm name from the Rhythm menu.

The Rhythm menu contains many Pops rhythms, more than can fit on the display page. To change the display pages, press the appropriate number buttons in the display.



The color of the selected rhythm name changes to orange, indicating that it has been selected.

Rhythm structure

Each rhythm is made up of “sections.” Since each section is a rhythmic variation of the basic rhythm, you can use them to add “spice” to your performance and mix up the beats while you are playing. You can freely change the section while the rhythm is played back.

INTRO

This is used for the beginning of the Song. There are three Intro sections that can be selected with the INTRO [1] – [3] buttons. When the Intro finishes playing, the rhythm automatically shifts to the Main section.

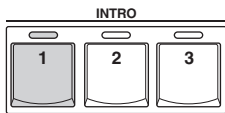

Selected Intro section's lamp is lit

MAIN

This is used for playing the main part of the Song. There are four Main sections that can be selected with the MAIN/FILL IN [A] – [D] buttons. The rhythm pattern of several measures repeats indefinitely.

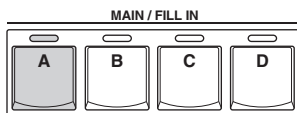

Selected Main section's lamp is lit

FILL IN

This is designed for use as a temporary and regular rhythmic pattern to spice up a repeating rhythm. There are four Fill In sections that can be played by pressing the selected (lit) MAIN/FILL IN [A] – [D] buttons as desired. When one measure pattern of a Fill In finishes playing, the rhythm automatically shifts to the Main section.

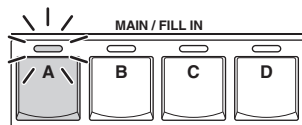

Selected Fill In section's lamp flashes

BREAK

This lets you add dynamic variations and breaks in the rhythm pattern. The Break section is selected by pressing the [BREAK] button. When the one-measure Break pattern finishes playing, the rhythm automatically shifts to the Main section.



The lamp is lit when the Break section is selected

ENDING

This is used for the ending of the Song. There are three Ending sections that can be selected with the ENDING [1] – [3] buttons. When the ending is finished, the rhythm automatically stops.

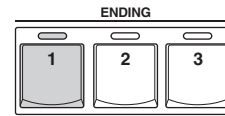

Selected Ending section's lamp is lit

Operating the rhythm from the panel

You can turn the rhythm on/off and switch the sections as desired by pressing the buttons on the panel. Using the Fill Ins and Break patterns let you add dynamic interest and “spice” to your performance.

To start/stop the rhythm:

START

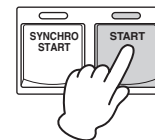

The rhythm begins as soon as the [START] button is pressed.

To stop the rhythm, press the button again.

SYNCHRO START

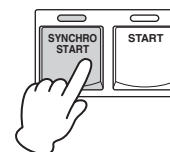

The [SYNCHRO START] button puts the rhythm in “standby.” The rhythm starts when you press a note on the Lower keyboard or Pedalboard.

When the A.B.C. mode is set to OFF, pressing the [SYNCHRO START] button again stops the rhythm. When the A.B.C. mode is set to something other than OFF, releasing the key from the Lower keyboard stops the rhythm.

When the A.B.C. mode is set to Custom A.B.C., releasing the keys both from the Lower Keyboard and the Pedalboard stops the rhythm.

Reference page

- Automatic Accompaniment – Auto Bass Chord (A.B.C.) (page 66)

INTRO

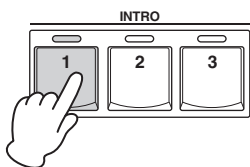

Pressing one of the INTRO [1] – [3] buttons automatically adds a short introduction before starting the actual (Main) rhythm.
 First press one of the INTRO [1] – [3] buttons, then press the [START] or [SYNCHRO START] button to actually start the rhythm.
 While the introduction is playing, the BAR/BEAT display shows the countdown to the first measure of the pattern. For example, if there is a four-measure lead-in for a pattern in 4/4 time, the display at right appears:

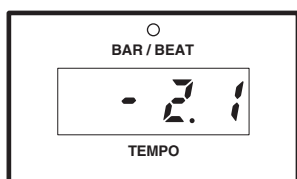

NOTE
 When an Intro or Ending pattern is playing, the Lower Keyboard cannot be played.

ENDING

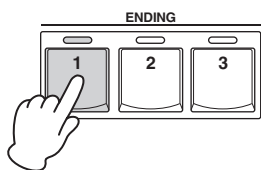

Pressing one of the ENDING [1] – [3] buttons automatically adds an ending phrase before stopping the rhythm.
 When you press the Ending button while rhythm is playing back, the rhythm will automatically stop after the ending phrase is played. You can have the ending gradually slow down (ritardando) by pressing the ENDING button once again, while the ending is playing.

NOTE
 Pressing the ENDING [1] button during playback of the Main section will first call up the Fill In pattern, then the Ending 1 pattern.

To switch the rhythm sections:

You can change the rhythm section of the Main phrase by pressing the desired MAIN/FILL IN [A] – [D] button. The selected section's lamp (above the button) is lit.

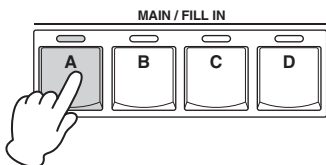

To use the Fill In patterns:

As you play the Electone along with the rhythm, occasionally press the selected MAIN/FILL button as desired. A Fill In pattern of one measure will be played and the selected Fill In section's lamp (above the button) flashes.

NOTE
 You can record the currently selected section to Registration Memory. However, you cannot record the on/off status of the Auto Fill In function.

When you use the Auto Fill In function, Fill Ins will be played automatically. The Auto Fill In function is set in the Rhythm Condition display. Pressing the selected Rhythm button on the panel again (or pressing the rhythm name of the selected rhythm in the display) calls up the Rhythm Condition display.

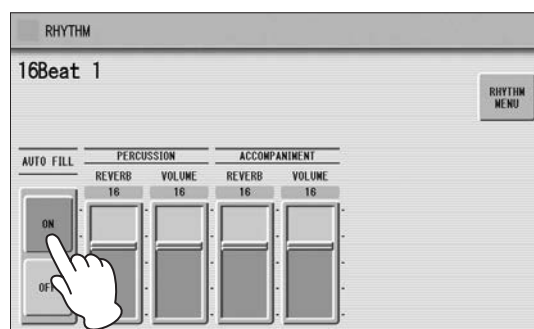

When Auto Fill is set to ON in the left side of the display, the Fill In pattern is automatically played whenever you switch the Main sections.

To use the Break patterns:

As you play the Electone along with the rhythm, occasionally press the [BREAK] button.

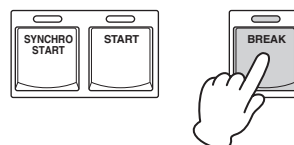

Moreover, you can start/stop the rhythm and switch the sections by using the Footswitch. See page 179 for details.

Changing the rhythm volume

There are two ways to set the rhythm volume: using the VOLUME buttons on the panel and using the volume slider in the display. The volume buttons let you make coarse adjustments to the volume while the slider gives you fine control.

Using VOLUME buttons on the panel (coarse):

Press one of the VOLUME buttons of the rhythm on the panel to set the desired level.

The buttons have seven volume settings, from a minimum of 0, or no sound, to a maximum of full volume.

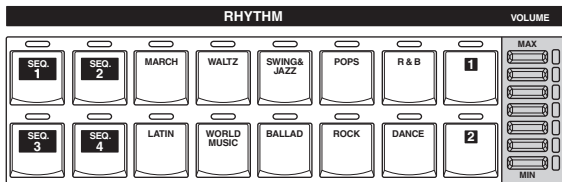

Using VOLUME slider in the display (fine):

Pressing the same rhythm button on the panel again (or pressing the rhythm name of the selected rhythm in the display) calls up the Rhythm Condition display.

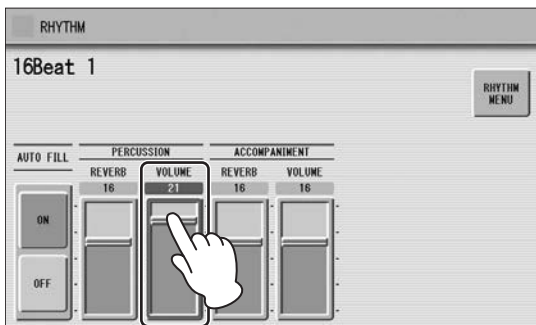

To set the volume, touch the PERCUSSION VOLUME slider in the display or use the Data Control dial. The control range is from 0 (no sound) to 24 (full volume).

NOTE

Depending on the volume value (set by the slider), two adjacent VOLUME button lamps may be lit at the same time, indicating an intermediate position.

Adjusting the tempo

Turn the TEMPO dial clockwise to increase the tempo, and counter-clockwise to decrease it.

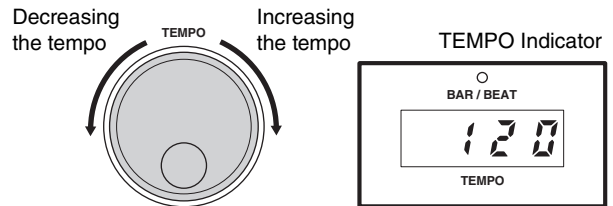

TEMPO display shows the current tempo. Displayed values are given in beats per minute.

The tempo range is 40 to 240 beats per minute.

When the rhythm begins playing, the TEMPO indicator changes function to a BAR/BEAT indicator.

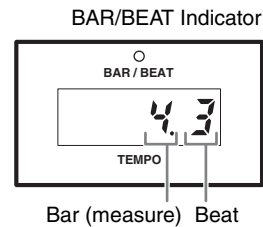

On the BAR/BEAT indicator, the number on the left indicates the current bar or measure and the one on the right indicates the number of the beat in each bar.

You can also see the Tempo and Bar/Beat indications in the Voice Display. In the Voice Display, both Tempo and Bar/Beat can be seen in one display.

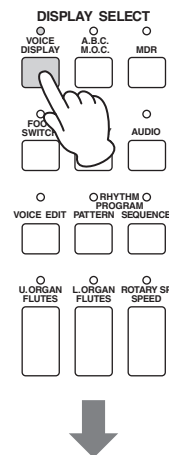

Reference page

- Voice Display (page 17)

Each rhythm has its original (preset) tempo. Press [PRESET TEMPO] button in the display to restore the tempo to the original setting.

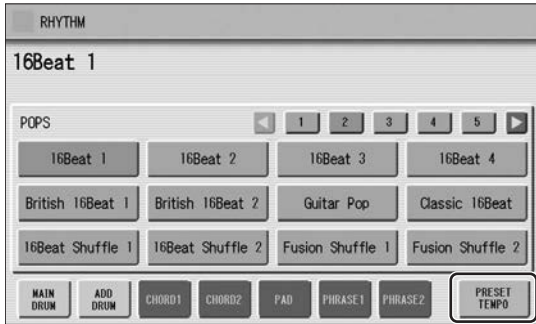

Changing the rhythm reverb

You can adjust the amount of reverb applied to the rhythms and the percussion sounds used in the rhythms in the Rhythm Condition display.

To adjust the amount of reverb, touch the slider in the display or use the Data Control dial.

Reference page

- Reverb (page 46)

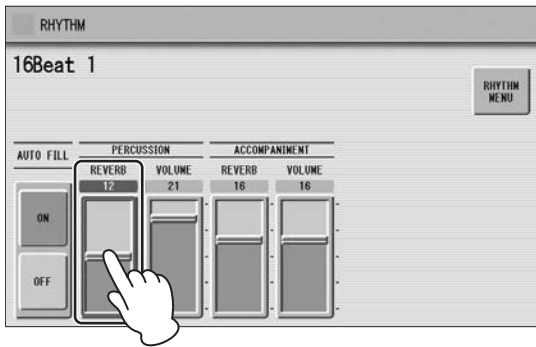

When the panel REVERB control is set to the minimum, the setting here will have no effect.

Range: 0 – 24

Selecting Rhythms from the User Buttons

As with the Voice sections, the Rhythm section also has User buttons (numbered 1 or 2) from which rhythms can be selected. You can select original User rhythms that you have created with the Rhythm Pattern Program function. This also allows you to assign two or three rhythms from the same category to be selected from different buttons; one from the original Rhythm button, and the others from the User buttons.

1 Press one of the User buttons at the right of the Rhythm buttons.

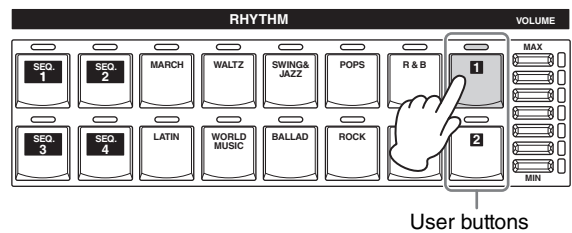

The Rhythm Menu appears in the display.

2 Select the desired rhythm category with the category buttons in the display.

You can also choose the “User” category to select a User rhythm you have created.

Reference page

- Rhythm Pattern Program (page 146)

The currently selected rhythm category appears in small letters above of the rhythm buttons in the display. Keep in mind that the rhythm name shown above the category name is that of the currently assigned rhythm and is irrelevant to the rhythm category.

Currently selected rhythm name

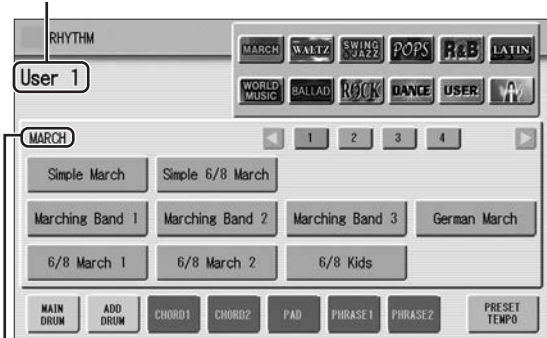

Currently selected rhythm category

3 Select a rhythm from the displayed Rhythm Menu.

Use the number buttons in the display to call up other rhythms in the category.

Rhythm List

This list shows all available rhythms on the Electone. Numbers written at the left side of each column in this list indicate the numbered buttons displayed in the Rhythm Menu.

MARCH

1	Simple March	*2
	Simple 6/8 March	*2
	Marching Band 1	
	Marching Band 2	*2
	Marching Band 3	
	German March	
	6/8 March 1	
	6/8 March 2	
	6/8 Kids	
	2	OrchestralMarch+
Anime Fantasy +		*1
Galaxy Ship		
SF March 1		
SF March 2 +		*1
Blockbuster		
Broadway		*2
Showtune +		*1
Wild West		
Pop Classics +		*1, *2
3		French 50s
	Alpine March	
	6/8 Organ March	*3
	Pub Piano	
	Sing-a-longPiano	
	Piano March	*2, *3
	Piano 6/8 March	*2, *3
	Piano Musical	*2, *3
	4	Baroque
Baroque Air		*3
Baroque Concerto		*3
Strings Adagio		*3
Strings Concerto		*3
ClassicalSerenad		*3
Choral Symphony		*3
Romantic Ballet		*2, *3
Brass Band Hymn+		*1, *3

WALTZ

1	Waltz	*2
	Simple Waltz	*3
	Orchestral Waltz	
	Vienna Waltz 1	
	Vienna Waltz 2	
	Vienna Waltz 3	
	Gentle Waltz 1	
	Gentle Waltz 2	
	Classic Waltz	
	Slow Waltz	

2	Jazz Waltz 1	
	Jazz Waltz 2	
	Jazz Waltz 3	
	Jazz Waltz 4	
	Jazz Waltz Med	
	Jazz Waltz Fast	
	Modern Waltz	
	Pop Waltz	
	Country Waltz	
	3	Mariachi
Banda Vals		
Snow Waltz		
Vocal Waltz		
Alpine Waltz		
AlpenLand 3/4		
Scand Hambo		
Highland Waltz		
Musette		
Italian Mazurka		
4	Italian Waltz	
	French Waltz	
	Movie Soundtrack	
	Choir Soundtrack	
	OrchestraBolero+	*1
	Romantic Waltz	*3
	Classical Menuet	*3
	Green Fantasia	*2, *3
	Guitar Serenade	*2, *3
	Piano Jazz Waltz	*2, *3

SWING&JAZZ

1	Simple Big Band	*2
	Simple ComboJazz	*2
	Simple Swing	
	Big Band 1	
	Big Band 2	
	Big Band 3	
	Big Band 4	
2	Big Band 5	
	Big Band 6	
	Big Band 7	
	Orch Big Band 1	
	Orch Big Band 2	
	Big Band Jazz	
	Big Band Fast	
	Classic Big Band	
	30s Big Band	
	Modern Big Band	
Mod BigBand Shfl		

2	Big Band Bop	
	Movie Panther	
	Jungle Drum	
3	Medium Jazz 1	
	Medium Jazz 2	
	Acoustic Jazz 1	
	Acoustic Jazz 2	
	Fast Jazz	
	Combo Swing	
	Cool Combo	
	Light Swing	
	InstrumentalJazz	
	Manhattan Swing	
4	Jazz Club	
	Bebop	
	Five-Four	
	Trad Piano Jazz	
	Piano Trio	
	Jazz Ballad 1	
	Jazz Ballad 2	
	Midnight Swing	
	Slow Jazz	
	Moonlight 1	
5	Moonlight 2	
	Dreamy Ballad	
	Winter Song 1	
	Winter Song 2	
	ChristmasShuffle	
	ChristmasBallad+	*1
	Movie Swing 1	
	Movie Swing 2	
	Guitar Swing	
	Afro Cuban 1	
6	Afro Cuban 2	
	Afro Cuban 3	
	Foxtrot 1	
	Foxtrot 2	
	Slowfox 1	
	Slowfox 2	
	Dixieland 1	
	Dixieland 2	
	Dixieland Jazz 1	
	Dixieland Jazz 2	*3
Ragtime 1		
7	Ragtime 2	
	Charleston	
	Quickstep	
	Orchestra Swing	
	Jazz Singers	
	Tap Dance Swing	

*1 Cannot be selected for creating a Rhythm Pattern Program.

*2 Contains a Section with no Auto Bass part. Such a Section cannot produce the bass sound even if A.B.C. is turned on.

*3 Contains a Section with no Drum part. When playing such a Section, make sure to turn Accompaniment on.

Rhythm List

7	Organ Groove	
	Piano Swing	*2, *3
	Piano JazzBallad	*2, *3
	Piano Stride	*2, *3

POPS

1	Simple 8Beat Pop	*2
	Simple 3/4 Pop	*2
	Simple Shffl Pop	*2
	8Beat Light 1	
	8Beat Light 2	
	8Beat Light 3	
	8Beat Light 4	
	Simple Shuffle 1	
	Simple Shuffle 2	
	Simple Shuffle 3	
2	16Beat 1	
	16Beat 2	
	16Beat 3	
	16Beat 4	
	British 16Beat 1	
	British 16Beat 2	
	Guitar Pop	
	Classic 16Beat	
	16Beat Shuffle 1	
	16Beat Shuffle 2	
	Fusion Shuffle 1	
	Fusion Shuffle 2	
3	Folk Rock 1	*2
	Folk Rock 2	
	SingerSongWriter	
	Easy Pop	
	Chart Guitar Pop	*2
	60s 8Beat	
	80s Boy Band	
	Surfin' 8Beat	
	Heart Beat	
	Finger Pickin'	
	4	Jazz Pop
Eurovision Pop		
British Pop		
Pop Shuffle		
Kool Shuffle		
Unplugged 1		*2
Unplugged 2		
Unplugged 3		
5	JPN Pop Shuffle	
	JPN Idol Hits	
	JPN 70s Anime +	*1
	JPN Soundtrack	
	Cute Pop	
	The 3rd Funk	
	Sunset DECA	
	US 70s TV Theme	
	UK Soul Pop	
6	Asian Pops	
	8Beat Adria	
	Scand Shuffle	
	Sing Along	

6	Jersey Pop	
	60s Vintage Pop	
	60s Chart Swing	
	Bubblegum Pop	
	Tijuana	
7	70s 8Beat	
	70s Country Pop	
	70s ChartCountry	*2
	Country Brothers	
	Euro Pop Organ	
	Euro Fox	
	Euro Pop	
Piano 8Beat	*2, *3	

R&B

1	Simple Funk	*2	
	Simpl R&B Ballad	*2	
	Simple R&B Shffl	*2	
	Soul 1		
	Soul 2		
	16Beat Soul 1		
	16Beat Soul 2		
	Soul Brothers		
	Frankly Soul		
	Live Soul Band +	*1	
	70s Chart Soul		
	2	Soul Swing	
		6/8 Soul	
		Amazing Gospel 1	
Amazing Gospel 2			
Gospel Brothers			
Gospel Sisters			
Hollywood Gospel			
Gospel Party			
New Gospel			
Gospel Shuffle			
3	Gospel Funk 1		
	Gospel Funk 2		
	Funk Beat 1		
	Funk Beat 2		
	Jazz Funk		
	Kool Funk +	*1	
4	Let's Funk		
	Motor City 1		
	Motor City 2		
	Detroit Pop 1		
	Detroit Pop 2		
	Blues Rock		
	Blueberry Blues+	*1	
	Cool Blues		
	Slow Blues		
	Blues Shuffle 1	*2	
	Blues Shuffle 2+	*1	
6/8 Blues			
Lovely Shuffle			
Modern Shuffle +	*1		
5	Cool R&B		
	70s Scat Legend		
	Modern R&B 1		

5	Modern R&B 2 +	*1
	Soul R&B	
	New R&B	
	Worship Medium	
	Worship Fast +	*1
	Worshp Power Bld	*2
	Piano Blues 1	*2, *3
	Piano Blues 2	*2, *3

LATIN

1	Simple BossaNova	*2
	Simple Samba	*2
	Simple Mambo	*2
	Simple Rumba	*2
	Bossa Nova 1	
	Bossa Nova 2	
	Bossa Nova 3	
	Bossa Nova 4	
	Pop Bossa 1	
	Pop Bossa 2	
2	Bossa Brazil	
	Lounge Bossa	
	Samba	
	Big Band Samba	
	Light Samba 1	
	Light Samba 2	
	Pop Samba 1	
3	Pop Samba 2	
	Jazz Samba	
	Mambo 1	
	Mambo 2	
	Big Band Mambo	
	Rumba	
	Pop Rumba	
	Fast Rumba	
	Rumba Flamenco	
	Cha Cha Cha	
4	Big Band Cha Cha	
	Pop Cha Cha 1	
	Pop Cha Cha 2	
	Salsa 1	
	Salsa 2	
	Salsa 3	
	Montuno	
	Calypso	
	Guaguanco	
	Danzon	
	Guajira	
5	Cuban Bolero	
	Bomba	
	Pop Latin	*2
	Beguine 1	
	Beguine 2	
	Tango 1	
	Tango 2	
	Tango 3	
	Italian Tango	
	Tango Orchestra	
Tango Milonga		

6	Guitar Rumba 1	*3
	Guitar Rumba 2	
	Piano Rumba	*2, *3
	Piano Cha Cha	*2, *3

WORLD MUSIC

1	Bolero		
	Flamenco		
	Pop Flamenco	*2	
	Pasodoble		
	Tarantella		
	Sirtaki		
	Scand Schottis		
	Hawaiian		
	Mexican Dance	*3	
	Enka		
	2	Polka 1	
		Polka 2	
		Banda Polka	*3
Orchestral Polka			
Zither Polka			
Italian Polka			
Scottish Polka			
Ober Polka			
Party Polka			
Euro Polka			
Polka Pop +		*1	
3		Irish Dance	
		Irish Hymn	*2
	Celtic Dance		
	Celtic Dance 3/4		
	Celtic Christmas		
	Scottish Reel		
4	Reggae		
	Happy Reggae		
	Sheriff Reggae 1		
	Sheriff Reggae 2		
	Shuffle Reggae		
	Caribbean		
	Zouk		
	Hully Gully		
	5	Hoedown 1	*3
Hoedown 2			
Bluegrass 1			
Bluegrass 2			
Modern Bluegrass			
Country Band			
Country Shuffle			
Country 2/4			
Pickin' Swing			
6		ChinaPopBallad 1	*2
	ChinaPopBallad 2		
	China Dance		
	China Trad 1		
	China Trad 2	*2	
	Kung Fu		
	Ethereal Voices	*2, *3	

BALLAD

1	Simple 8BtBallad	*2
	SimpleRockBallad	*2
	8Beat Ballad	
	Acoustic 8Bt Bld	*2
	8Beat Modern	
	16Beat Ballad 1	
	16Beat Ballad 2	
	16Beat Ballad 3	
	16Beat Ballad 4	
	2	6/8 Ballad
6/8 Slow Rock 1		
6/8 Slow Rock 2		
6/8 Slow Rock 3		
6/8 Orchestral 1		
6/8 Orchestral 2		
Schlager 6/8		
Moonlight 6/8		
Euro Slow Rock		
Acoustic Ballad		
3	Power Ballad	
	Easy Ballad	
	Romantic Ballad	
	Love Song	
	Epic Ballad +	*1
	Dramatic Ballad	*3
	Animation Ballad	
	Secret Service	
	70s Cool Ballad	
	80s SmoothBallad	
90s Cool Ballad		
4	Pop Evergreen	
	VocalPopBallad +	*1, *2
	70s Pop Duo 1	
	70s Pop Duo 2	
	70s Glam Piano	
	Movie Ballad 1	
	Movie Ballad 2	
	80s Movie Ballad	
	BigScreenClassic	
	5	Chart Ballad
Analog Ballad		
Pop Ballad		
Modern PopBallad		*2
New R&B Ballad		
Slow&Easy 1		
Slow&Easy 2		
Chillout		*2
Country Rock Bld		
Easy Country		
6	JPN Romantic Bld	
	JPN FolkPopDuo	
	JPN Dance Ballad	*2
	JPN R&B Ballad	
	JPN TVSoundtrack	*2
	On Broadway	*2, *3
	Coudy Bay +	*1, *3
	Night Walk +	*1, *2, *3

6	Organ Ballad 1	
	Organ Ballad 2	
7	Guitar Ballad 1	
	Guitar Ballad 2	
	Guitar Ballad 3	
	Pop Gtr Ballad	
	Piano Ballad	
	ClassicPianoBld	*3
	ElecPiano Ballad	
	Pop Piano Ballad	*2
	Piano8BeatBallad	*2, *3
	Piano Slow Rock	*2, *3
PianoOrchBallad	*3	

ROCK

1	Simple Rock	*2
	Simple Shfl Rock	*2
	Hard Rock 1	
	Hard Rock 2	
	Hard Rock 3 +	*1
	Tears Rock 1	
	Tears Rock 2	
	British Rock	*2
	Soft Rock	
	2	Power Rock
Stadium Rock +		*1
Contemp Rock +		*1
Standard Rock		
Acoustic Rock		
Brit Rock Pop +		*1
German Rock		
Funk Pop Rock		
Chart Rock Shfl+		*1
ChartPianoShfl +		*1
Beach Rock		
Surf Rock		
3	60s Rock 1	
	60s Rock 2	
	60s Rock 3 +	*1
	60s Rock 4 +	*1
	70s Rock +	*1
	80s Power Rock+	*1
	80s Synth Rock+	*1
	80s Pop Rock +	*1
	80s Guitar Pop+	*1
	00s Boy Band	
4	Rock Shuffle 1	
	Rock Shuffle 2	
	Rock Shuffle 3 +	*1
	70s RockShuffle+	*1
	Rock&Roll 1	
	Rock&Roll 2	
	Rock&Roll 3 +	*1
	6/8 Rock	
	60s Rock&Roll +	*1
	Rock&RollShuffle	*3
Jive		
Skiffle		
5	Boogie Woogie 1	

Rhythm List

5	Boogie Woogie 2		
	Swingin' Boogie		
	Oldies Rock&Roll		
	Croco Twist +	*1	
	Southern Rock		
	Cowboy Rock		
	Scand Bugg		
	Country Rock 1		
	Country Rock 2		
	Country Blues		
	New Country	*2	
	6	Country Straits+	*1
		Country Strum	
Irish Rock			
60s Rising Pop		*2	
Alp Rock +		*1	
Caribbean Rock 1			
Caribbean Rock 2			
Disco Fox Rock +		*1, *2	
JPN Pop Rock 1			
JPN Pop Rock 2			
JPN Band Rock 1			
JPN Band Rock 2			
7	JPN Light Rock 1		
	JPN Light Rock 2		
	JPN Rock Duo +	*1	
	JPN Idol Rock		
	JPN Kids Hero		
	Dragon Rock		
	Miracle Rock	*2	
	Pretty Cute		
Happy Pop			

DANCE

1	Simple DancePop+	*1, *2
	Simple Disco	*2
	Ibiza 1	
	Ibiza 2	
	Ibiza 3	*3
	Trance Pop	
	Euro Trance 1	
	Euro Trance 2	*2
	6/8 Trance 1	
	6/8 Trance 2	
2	Club Dance 1	*2
	Club Dance 2 +	*1, *2
	Club Dance 3	
	Global DJ's	
	Dancefloor	*2
	Techno Party	
	Dream Dance	
	80s Dance	
	Club House	
	Swing House	
Funky House		
3	Dirty Pop	
	Mallorca Party +	*1, *2
	Party Arena	
Apres Ski Hit		

3	Disco Rock +	*1, *2	
	Disco Fox		
	Mallorca Disco +	*1, *2	
	Disco Palace		
	Disco Philly 1		
	Disco Philly 2		
	Disco Teens 1	*2	
	Disco Teens 2		
	4	Disco Funk 1	
		Disco Funk 2	
Disco Chocolate			
Dance Pop			
US Disco			
Saturday Night +		*1	
Disco Fever			
90s Disco			
70s Disco 1			
70s Disco 2			
70s Disco 3			
5	Trip Hop	*2	
	Chart Pop 1		
	Chart Pop 2		
	Ground Beat		
	Synth Pop		
	Synth Pop Duo +	*1	
	US Pop		
	UK Pop		
	Turkish Eurobeat	*2	
	Oriental Pop		
6	Pop Beat 1		
	Pop Beat 2		
	Funky Dance		
	Dancehall		
	Garage 1		
	Garage 2 +	*1	
	Electronica +	*1	
	Latin DJ's		
	Club Latin		
	Latin Disco 1		
Latin Disco 2			
7	US Hip Hop 1		
	US Hip Hop 2 +	*1, *2	
	Euro Hip Hop 1		
	Euro Hip Hop 2 +	*1	
	Hip Hop Pop		
	Hip Hop Light		
	Hip Hop Groove		
	Classic Hip Hop		
	Pop R&B		
	8	JPN Idol Pop 1 +	*1
JPN Idol Pop 2			
JPN Idol Pop 3			
JPN Dance Pop 1			
JPN Dance Pop 2			
Cute Techno			
Dance Police			

METRONOME

1	Metronome 2/4 +	*1, *2
	Metronome 3/4 +	*1, *2
	Metronome 4/4 +	*1, *2
	Metronome 6/8 +	*1, *2
	Metronome 9/8 +	*1, *2
	Metronome 12/8 +	*1, *2
	Metronome 5/4 +	*1, *2
	Metronome 7/4 +	*1, *2
	Metronome 8/4 +	*1, *2
	2	Click 2/4 +
Click 3/4 +		*1, *2
Click 4/4 +		*1, *2
Click 6/8 +		*1, *2
Click 9/8 +		*1, *2
Click 12/8 +		*1, *2
Click 5/4 +		*1, *2
Click 7/4 +		*1, *2
Click 8/4 +		*1, *2
3		Cowbell 2/4 +
	Cowbell 3/4 +	*1, *2
	Cowbell 4/4 +	*1, *2
	Cowbell 6/8 +	*1, *2
	Cowbell 9/8 +	*1, *2
	Cowbell 12/8 +	*1, *2
	Cowbell 5/4 +	*1, *2
	Cowbell 7/4 +	*1, *2
	Cowbell 8/4 +	*1, *2
	4	WoodBlock 2/4 +
WoodBlock 3/4 +		*1, *2
WoodBlock 4/4 +		*1, *2
WoodBlock 6/8 +		*1, *2
WoodBlock 9/8 +		*1, *2
WoodBlock 12/8 +		*1, *2
WoodBlock 5/4 +		*1, *2
WoodBlock 7/4 +		*1, *2
WoodBlock 8/4 +		*1, *2

Accompaniment

The Accompaniment function provides arpeggiated chords and other instrumental embellishments when rhythms are used.

Accompaniment controls are selected from the Rhythm Menu and Rhythm Condition display.

1 Press any one of the RHYTHM buttons once.

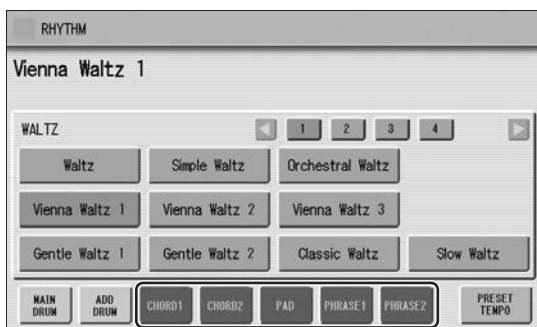

Accompaniment parts

At the bottom of the display, there are seven part buttons, such as Chord 1, Chord 2, Pad, and so on. These parts, with the exception of Main Drum and Add Drum, are Accompaniment parts.

2 Turn the desired parts on.

The Accompaniment consists of five parts, Chord 1, Chord 2, Pad, Phrase 1, and Phrase 2, and each of them can be set to on or off by pressing corresponding button in the display.

If you turn all the parts off, the Accompaniment does not sound.

CHORD 1/CHORD 2:

These are the rhythmic chord backing parts.

PAD:

This part features sustained chords and commonly uses lush sounds such as strings and organ.

PHRASE 1/PHRASE 2:

These parts are used for various embellishments and riffs that enhance the Song, such as brass section accents and chord arpeggios.

Not all parts contain accompaniment data. Some parts may be empty depending on the selected rhythm and rhythm section.

Main Drum and Add Drum contains drum and percussion rhythm patterns.

When you turn both Main Drum and Add Drum off, the drum and percussion do not sound. Generally, Main Drum contains the main part of the rhythm and Add drum has additional percussion sounds, such as tambourine.

3 Adjust the volume and amount of reverb applied to the Accompaniment.

Pressing the same rhythm button on the panel again calls up the Rhythm Condition display.

The two sliders at the right side of the display can control the Accompaniment volume and reverb.

Touch the slider in the display or use the Data Control dial to adjust the volume/reverb.

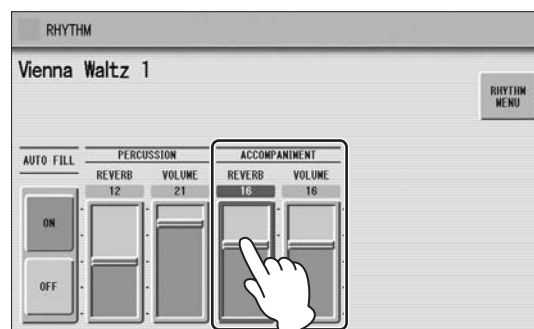

Automatic Accompaniment – Auto Bass Chord (A.B.C.)

The Auto Bass Chord (A.B.C.) function works with the Rhythm section of the Electone to automatically produce bass accompaniment as you play. It adds an entirely new dimension to your performance by effectively putting a full backing band at your disposal. One of three different modes (Single Finger, Fingered Chord, Custom A.B.C.) is used for producing Automatic Accompaniment patterns. Before using the A.B.C. function, turn Pedal Poly off. If Pedal Poly is set to on, the bass pattern of the A.B.C. will not sound.

Reference page

- POLY (page 44)

To set the A.B.C. function:

Press the [A.B.C./M.O.C.] button.

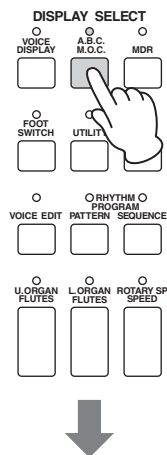

A.B.C./M.O.C. display

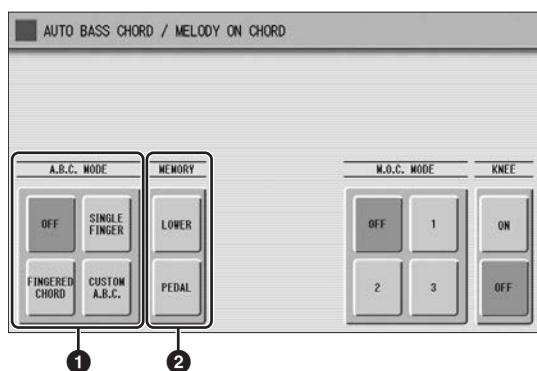

The A.B.C./M.O.C. display appears. The A.B.C. section is at the left half of this display.

❶ A.B.C. MODE

OFF:

Cancels the Auto Bass Chord function.

SINGLE FINGER:

The Single Finger mode provides the fastest and easiest means to obtain many different chord/bass combinations. You can produce major, minor, 7th, and minor 7th chords by simply using one, or at most, two or three fingers to play the chords. The chord produced will sound in the same octave regardless of where it is played on the Lower keyboard.

Key of C



Major chords:

Press the root of the chord (the note that corresponds to the chord's name).



Minor chords:

Simultaneously press the root and any one black key to the left of it.



7th chords:

Simultaneously press the root and any one white key to the left of it.

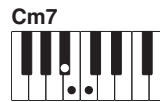

Minor 7th chords:

Simultaneously press the root as well as any black key and any white key to the left of it.

Playing single finger chords without the use of the rhythm lets you add full continuous chords to your performance.

FINGERED CHORD:

The Fingered Chord mode automatically produces bass accompaniment for chords played in the Lower keyboard. It allows you to use a wider range of chord types than in the Single Finger mode. In the Fingered Chord mode, you play full chords while the Auto Bass Chord function automatically selects the appropriate bass pattern. If you play only one or two notes in the Lower keyboard, the appropriate chord will sound based on the previously played chord.

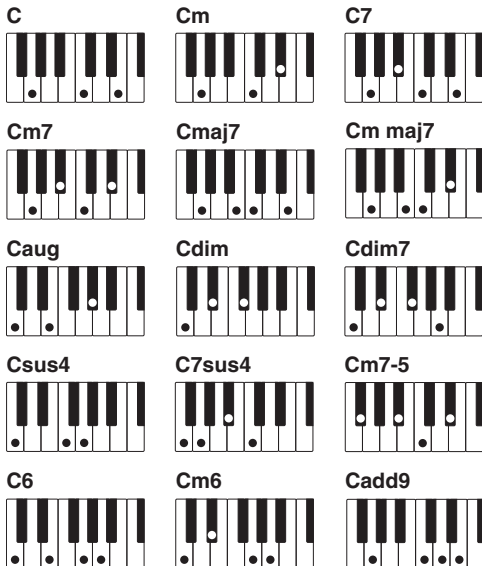
Key of C**NOTE**

When playing certain chords (aug, dim7, sus4, 6, and m6), make sure to play the root of the chord as the lowest note in that chord.

Playing fingered chords without the use of the rhythm lets you add full continuous chords to your performance.

CUSTOM A.B.C.:

The Custom A.B.C. mode is a slight variation on the Fingered Chord mode. It allows you to determine what bass notes will be played in the accompaniment by playing a note on the Pedalboard along with the chords you play in the Lower keyboard.

2 MEMORY**LOWER:**

When this is set to on, the Lower keyboard Voices and chord accompaniment keep playing even after you release your fingers from the Lower keyboard, while the rhythm plays.

PEDAL:

When this is set to on, the Pedalboard Voices and bass accompaniment keep playing even after you release your foot from the Pedalboard, while the rhythm plays.

(In the Single Finger and Fingered modes:) When this is set to on, the bass accompaniment of the Pedalboard Voices keeps playing even after you release your fingers from the Lower keyboard.

When you start the rhythm with [SYNCHRO START] button, set the Lower/Pedal Memory to on. When Memory is off, releasing your fingers from the Lower keyboard stops the rhythm.

Melody On Chord (M.O.C.)

The Melody On Chord (M.O.C.) feature automatically adds a harmony part to the melodies you play on the Upper keyboard. The harmony is derived from the chords you play on the Lower keyboard — or from the chords that are played for you, if you use Automatic Accompaniment. Melody On Chord has three different modes, each providing a different set of harmonics to accompany the melody played. Melody On Chord can also be controlled with the Knee Lever.

To set the M.O.C. function:

Press the [A.B.C./M.O.C.] button.

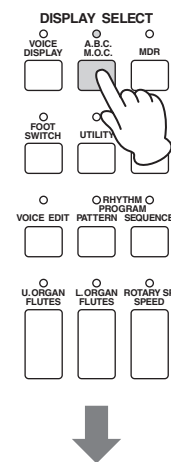
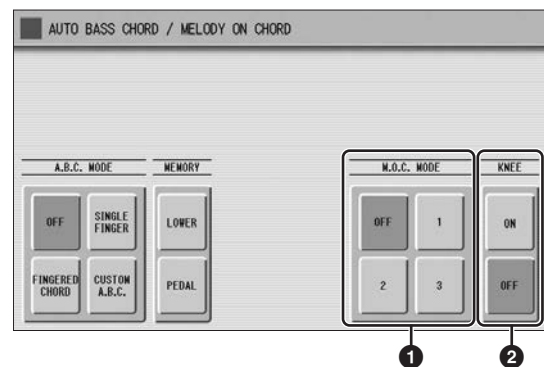
**A.B.C./M.O.C. display**

The A.B.C./M.O.C. display appears. The M.O.C. section is at the right half of this display.

1 M.O.C. MODE**OFF:**

Cancels the Melody On Chord function.

Mode 1:

Produces harmonies of up to two notes in a range close to the melody played.

Mode 2:

Produces harmonies of up to three notes in a range close to the melody played.

Mode 3:

Produces harmonies of up to four notes in a range relatively distant from the melody played.

2 KNEE

On/off switch for Knee Lever control over Melody On Chord operation. To use the Melody On Chord function with Knee Lever control, first switch the Knee setting to ON, then select one of the three modes (described above). When the control is on, pressing the Knee Lever to the right activates the Melody On Chord function.

Reference page

- Controlling Melody On Chord (with Knee Lever); (page 181)

Melody On Chord can be heard only when the Upper Keyboard Voice section's volume is set to the appropriate value. Melody On Chord does not apply to the Lead Voices.

Keyboard Percussion

The Keyboard Percussion function features many types of drum and percussion sounds, playable from the keyboards and Pedalboard.

Keyboard Percussion has two different modes, Preset and User. Preset Keyboard Percussion lets you play the preset drum kit sounds from the keyboards (assigned beforehand to the keys), while the User Keyboard Percussion lets you freely assign the drum sounds to any key or pedal you wish.

Using the Preset Keyboard Percussion

- 1 Turn off the Upper, Lower and/or Pedal Voices by setting each Voice's volume to MIN.

NOTE

In the Voice Display, each Voice section can be muted (page 16).

- 2 Turn on the Keyboard Percussion function by pressing the **KEYBOARD PERCUSSION [1]** or **[2]** button.

The Keyboard Percussion (K.B.P.) display appears.

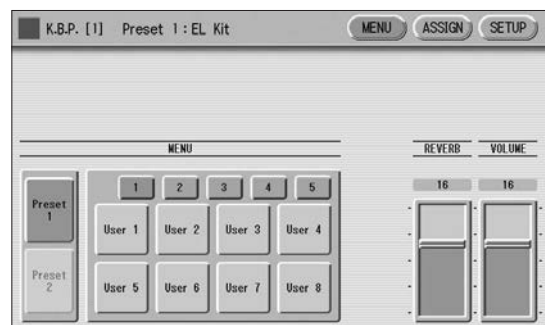

Pressing the **KEYBOARD PERCUSSION [1]** button calls up the Preset 1 kit on the Upper/Lower keyboards, and pressing the **[2]** button calls up the Preset 2 kit on the Pedalboard.

NOTE

Two Keyboard Percussion sets, [1] and [2], can be played at the same time by setting both buttons to on.

- 3 Press the [ASSIGN] button at the top right in the display to call up the ASSIGN Page.
- 4 Press the [KIT CHANGE] button at the center of the display to call up the Keyboard Percussion Kit List.

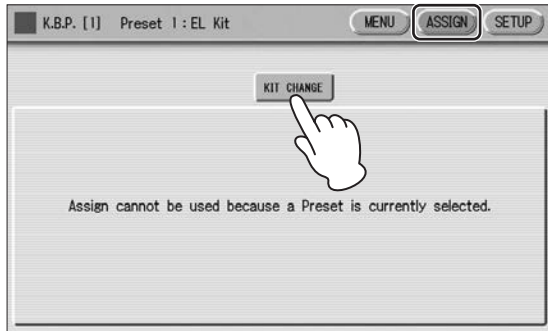

Press the kit name you want to use from the 38 Keyboard Percussion types. For details of percussion assignments for each kit, see the Preset Keyboard Percussion List on page 70.

The message “Are you sure you want to reset the setup data to the default values?” may appear when you change the kit. Select [OK] to clear all assignments (made in the ASSIGN Page only when User is selected) and detailed settings (made in the SETUP Page) and call up the selected kit on the panel. Select [CANCEL] to call up the selected kit without erasing the assignments and detailed settings.

- 5 Adjust the volume and amount of reverb applied to the Keyboard Percussion.

Two sliders in the K.B.P. display determine the reverb and volume settings. To adjust the volume and amount of reverb, touch the slider in the display or use the Data Control dial.

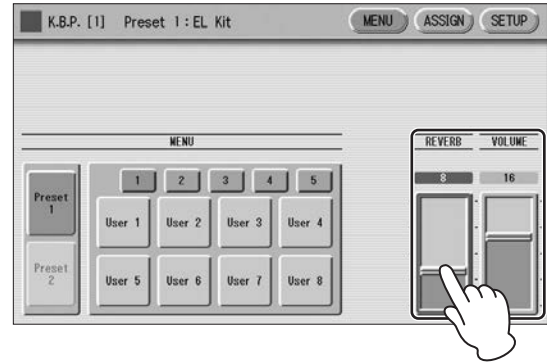

The settings here determine the reverb/volume for the entire Keyboard Percussion setup, not for each percussion instrument. You can, however, adjust each percussion instrument's reverb/volume (page 83).

- 6 Play some notes on the keyboards and/or Pedalboard.

5 Rhythm/Keyboard Percussion

Preset Keyboard Percussion List

	EL Kit			Standard Kit 1*		
	Preset 1 (UK)	Preset 1 (LK)	Preset 2 (PK)	Preset 1 (UK)	Preset 1 (LK)	Preset 2 (PK)
C1	-	-	Bass Drum Heavy	-	-	Kick
D1	-	-	SD Brush Roll	-	Surdo Mute	Side Stick
E1	-	Claves	Snare Drum Heavy	-	Surdo Open	Snare
F1	-	SD Brush Shot 1	SD Reverb 1	-	Hi Q	Hand Clap
G1	-	SD Reverb 1	Snare Drum Light	-	Whip Slap	Snare Tight
A1	-	Snare Drum Heavy	Snare Drum Rim 1	-	Scratch H	Floor Tom L
B1	-	Synth Tom 3	Tom 3	-	Scratch L	Hi-Hat Closed
C2	-	Concert BD	Snare Drum Rim 1	-	Finger Snap	Floor Tom H
D2	-	Synth Tom 2	Tom 2	-	Click Noise	Hi-Hat Pedal
E2	-	Bass Drum Heavy	Hi-Hat Closed	-	Metronome Click	Low Tom
F2	-	Synth Tom 1	Tom 1	-	Metronome Bell	Hi-Hat Open
G2	-	Bass Drum Light	Hi-Hat Open	-	Seq Click L	Mid Tom L
A2	-	Snare Drum Heavy	Ride Cymbal 1	-	Seq Click H	Mid Tom H
B2	-	SD Brush Roll	Synth Tom 3	-	Brush Tap	Crash Cymbal 1
C3	-	Snare Drum Heavy	Crash Cymbal 1	-	Brush Swirl	High Tom
D3	-	SD Brush Shot 1	Synth Tom 2	-	Brush Slap	Ride Cymbal 1
E3	-	SD Reverb 1	Orchestra Cymbal	-	Brush Tap Swirl	Chinese Cymbal
F3	-	Snare Drum Light	-	-	Snare Roll	Ride Cymbal Cup
G3	-	Tom 3	Synth Tom 1	-	Castanet	Tambourine
A3	-	Snare Drum Rim 1	-	-	Snare Soft	Splash Cymbal
B3	-	Tom 2	-	-	Sticks	
C4	-	Hi-Hat Closed	-	-	Kick Soft	
D4	-	Tom 1	-	-	Open Rim Shot	
E4	-	Hi-Hat Open	-	-	Kick Tight	
F4	-	Ride Cymbal 1	-	Bongo H	Kick	
G4	-	Orch Snare Drum	-	Bongo L	Side Stick	
A4	-	Crash Cymbal 1	-	Conga H Mute	Snare	
B4	-	Snare Drum Roll	-	Conga H Open	Hand Clap	
C5	-	Orchestra Cymbal	-	Conga L	Snare Tight	
D5	-	Orch Cymbal Roll	-	Timbale H	Floor Tom L	
E5	-	Triangle Mute	-	Timbale L	Hi-Hat Closed	
F5	-	Tambourine	-	Agogo H	Floor Tom H	
G5	-	Triangle Open	-	Agogo L	Hi-Hat Pedal	
A5	-	Castanet	-	Cabasa	Low Tom	
B5	-	Cowbell 1	-	Maracas	Hi-Hat Open	
C6	-	Timbale 1 Low	-	Samba Whistle H	Mid Tom L	
D6	-	Timbale 1 High	-	Samba Whistle L	Mid Tom H	
E6	-	Wood Block Low	-	Guiro Short	Crash Cymbal 1	
F6	-	Conga Low	-	Guiro Long	High Tom	
G6	-	Wood Block High	-	Claves	Ride Cymbal 1	
A6	-	Conga High	-	Wood Block H	Chinese Cymbal	
B6	-	Bongo Low	-	Wood Block L	Ride Cymbal Cup	
C7	-	Agogo Low	-	Cuica Mute	Tambourine	
D7	-	Bongo High	-	Cuica Open	Splash Cymbal	
E7	-	Agogo High	-	Triangle Mute	Cowbell	
F7	-	Cuica Low	-	Triangle Open	Crash Cymbal 2	
G7	-	Hand Claps	-	Shaker	Vibraslap	
A7	-	Cuica High	-	Jingle Bells	Ride Cymbal 2	
B7	-	Shaker	-	Bell Tree	-	
C8	-	-	-	-	-	
D8	-	-	-	-	-	
E8	-	-	-	-	-	
F8	-	-	-	-	-	
G8	-	-	-	-	-	
A8	-	-	-	-	-	
B8	-	-	-	-	-	
C9	-	-	-	-	-	
D9	-	-	-	-	-	
E9	-	-	-	-	-	
F9	-	-	-	-	-	
G9	-	-	-	-	-	
A9	-	-	-	-	-	
B9	-	-	-	-	-	
C10	-	-	-	-	-	
D10	-	-	-	-	-	
E10	-	-	-	-	-	
F10	-	-	-	-	-	
G10	-	-	-	-	-	
A10	-	-	-	-	-	
B10	-	-	-	-	-	
C11	-	-	-	-	-	
D11	-	-	-	-	-	
E11	-	-	-	-	-	
F11	-	-	-	-	-	
G11	-	-	-	-	-	
A11	-	-	-	-	-	
B11	-	-	-	-	-	
C12	-	-	-	-	-	
D12	-	-	-	-	-	
E12	-	-	-	-	-	
F12	-	-	-	-	-	
G12	-	-	-	-	-	
A12	-	-	-	-	-	
B12	-	-	-	-	-	
C13	-	-	-	-	-	
D13	-	-	-	-	-	
E13	-	-	-	-	-	
F13	-	-	-	-	-	
G13	-	-	-	-	-	
A13	-	-	-	-	-	
B13	-	-	-	-	-	
C14	-	-	-	-	-	
D14	-	-	-	-	-	
E14	-	-	-	-	-	
F14	-	-	-	-	-	
G14	-	-	-	-	-	
A14	-	-	-	-	-	
B14	-	-	-	-	-	
C15	-	-	-	-	-	
D15	-	-	-	-	-	
E15	-	-	-	-	-	
F15	-	-	-	-	-	
G15	-	-	-	-	-	
A15	-	-	-	-	-	
B15	-	-	-	-	-	
C16	-	-	-	-	-	

 : Indicates the keys of the ELS-02/ELS-02C keyboard.

* Standard Kit 2, Hit Kit, Room Kit, Rock Kit, Electro Kit, Analog Kit, Dance Kit, Jazz Kit, Brush Kit, Symphony Kit, Live!Studio Kit, Live!Power Kit 1, Live!Power Kit 2 and Live!Rock Kit have the same sound assignments as Standard Kit 1.

Keyboard Percussion

		Live!RealBrushes			Analog T8 Kit		
		Preset 1 (UK)	Preset 1 (LK)	Preset 2 (PK)	Preset 1 (UK)	Preset 1 (LK)	Preset 2 (PK)
C1	C#1	-	Surdo Mute	KickJazzAmbience Stick Brush	-	Surdo Mute	Kick T8 1 Snare T8 Rim
D1	D#1	-	Surdo Open	Vintage Slap 4	-	Surdo Open	Snare T8 2
E1		-	Hi Q	Clap Power	-	Hi Q	Clap T9
F1	F#1	-	Whip Slap	Vintage Slap 5	-	Whip Slap	Snare T8 1
G1	G#1	-	Scratch H	TomRealBrushes 1	-	Scratch H	Tom T8 1
A1	A#1	-	Scratch L	Hi-Hat Closed RB	-	Scratch L	Hi-Hat Closed T8
B1		-	Finger Snap	TomRealBrushes 2	-	Snare Hammer	Tom T8 2
C2	C#2	-	Click Noise	Hi-Hat Pedal RB	-	Kick Zap Hard	Hi-Hat Pedal T8
D2	D#2	-	Metronome Click	TomRealBrushes 3	-	Snare Garg L	Tom T8 3
E2		-	Metronome Bell	Hi-Hat Open RB	-	Kick Tek Power	Hi-Hat Open T8
F2	F#2	-	Vintage Tip	TomRealBrushes 4	-	Kick Slimy	Tom T8 4
G2	G#2	-	Vintage Swirl 1	TomRealBrushes 5	-	Kick T8 4	Tom T8 6
A2	A#2	-	Vintage Slap 1	CrashCymbal RB 1	-	Snare Analog CR	Crash Cymbal T8
B2		-	Vintage Swirl 2	TomRealBrushes 6	-	Snare T8 7	Tom T8 7
C3	C#3	-	Vintage Slap 2	Ride Cymbal RB	-	SnareClap Analog	Ride Cymbal T9
D3	D#3	-	Vintage TapSwirl	ChinaCymbal RB	-	Snare T8 6	China Cymbal 2
E3		-	VintageSlapSwirl	Ride Cup RB 1	-	Tom T8 5	RideCymbal Cup 2
F3	F#3	-	Vintage Swirl 3	Tambourine	-	Snare T8 5	Tambourine RX5
G3	G#3	-	Vintage Slap 3	Splash Cymbal RB	-	Kick T8 3	Splash Cymbal
A3	A#3	-	Sticks		-	Snare T8 4	
B3		-	Kick Soft L		-	Kick T8 2	
C4	C#4	-	Open Rim Shot RB		-	Snare T8 3	
D4	D#4	-	Kick Soft H		-	T8 Kick Bass	
E4		-	Bongo H	KickJazzAmbience	Conga T8 5	Kick T8 1	
F4	F#4	-	Bongo L	Stick Brush	Conga T8 4	Snare T8 Rim	
G4	G#4	-	Conga H Mute	Vintage Slap 4	Conga T8 3	Snare T8 2	
A4	A#4	-	Conga H Open	Clap Power	Conga T8 2	Clap T9	
B4		-	Conga L	Vintage Slap 5	Conga T8 1	Snare T8 1	
C5	C#5	-	Timbale H	TomRealBrushes 1	Timbale H	Tom T8 1	
D5	D#5	-	Timbale L	Hi-Hat Closed RB	Timbale L	Hi-Hat Closed T8	
E5		-	Agogo H	TomRealBrushes 2	Glass H	Tom T8 2	
F5	F#5	-	Agogo L	Hi-Hat Pedal RB	Glass L	Hi-Hat Pedal T8	
G5	G#5	-	Cabasa	TomRealBrushes 3	Cabasa	Tom T8 3	
A5	A#5	-	Maracas	Hi-Hat Open RB	Maracas T8	Hi-Hat Open T8	
B5		-	Samba Whistle H	TomRealBrushes 4	Fx Gun 2	Tom T8 4	
C6		-	Samba Whistle L	TomRealBrushes 5	Fx Gun 1	Tom T8 6	
		-	Guiro Short	CrashCymbal RB 1	Analog Shaker H	Crash Cymbal T8	
		-	Guiro Long	TomRealBrushes 6	Analog Shaker L	Tom T8 7	
		-	Claves	Ride Cymbal RB	Claves T8	Ride Cymbal T9	
		-	Wood Block H	ChinaCymbal RB	Hi Q 1	China Cymbal 2	
		-	Wood Block L	Ride Cup RB 1	Hi Q 2	RideCymbal Cup 2	
		-	Cuica Mute	Tambourine	Scratch H 2	Tambourine RX5	
		-	Cuica Open	Splash Cymbal RB	Scratch L 2	Splash Cymbal	
		-	Triangle Mute	Cowbell	Triangle Mute	Cowbell T8	
		-	Triangle Open	CrashCymbal RB 2	Triangle Open	Crash Cymbal 4	
		-	Shaker	Vibraslap	Analog Shaker	Vibraslap	
		-	Jingle Bells	Ride Cup RB 2	Sleigh Bells	Ride Cymbal 3	
		-	Wind Chime	-	Wind Chime	-	
		-	-	-	Snare Hip 1	-	
		-	-	-	Snare Hip 2	-	
		-	-	-	Snare Hip Gate	-	
		-	-	-	Snare Break 1	-	
		-	-	-	Kick Blip	-	
		-	-	-	Snare Fx 1	-	
		-	-	-	Kick Fx Hammer	-	
		-	-	-	-	-	
		-	-	-	-	-	
		-	-	-	-	-	
		-	-	-	-	-	

		Analog T9 Kit			House Kit		
		Preset 1 (UK)	Preset 1 (LK)	Preset 2 (PK)	Preset 1 (UK)	Preset 1 (LK)	Preset 2 (PK)
C1	C#1	-	Surdo Mute	Kick T9 3	-	-	Kick T9 5
D1	D#1	-	Surdo Open	Snare T9 Rim	-	W Kick	Snare T9 Rim
E1		-	Hi Q	Clap T9	-	WhiteNoiseDown 1	Clap T9
F1	F#1	-	Whip Slap	Snare T9 2	-	PinkNoise Down 1	Snare T9 2
G1	G#1	-	Scratch H	Tom T9 1	-	WhiteNoiseDown 2	Tom T9 1
A1	A#1	-	Scratch L	Hi-Hat Closed T9	-	PinkNoise Down 2	Hi-Hat Closed T8
B1		-	Snare Drum&Bass1	Tom T9 2	-	White Noise Up 2	Tom T9 2
C2	C#2	-	Kick Break 2	Hi-Hat Pedal T9	-	White Noise Up 1	Hi-Hat Pedal T9
D2	D#2	-	Snare Distortion	Tom T9 3	-	Pink Noise Up	Tom T9 3
E2		-	Kick Tek Power	Hi-Hat Open T9	-	WhiteNoiseUp Rel	Hi-Hat Open T9
F2	F#2	-	KickDistortionRM	Tom T9 4	-	PinkNoise Up Rel	Tom T9 4
G2	G#2	-	Kick T9 2	Tom T9 5	-	Kick T9 4	Tom T9 5
A2	A#2	-	-	-	-	-	-
B2		-	Snare Analog CR	Crash Cymbal T9	-	Snare T8 Rim	Crash Cymbal T9
C3	C#3	-	Snare T9 5	Tom T9 6	-	Snare T8 5	Tom T9 6
D3	D#3	-	Clap Analog Sm	Ride Cymbal T9	-	Hand Clap	Ride Cymbal T9
E3		-	Snare T9 Gate 1	China Cymbal 2	-	Snare Garg L	Crash Cymbal 4
F3	F#3	-	Snare Rock Roll	RideCymbal Cup 2	-	Snare Roll	RideCymbal Cup 2
G3	G#3	-	Snare T9 3	Tambourine RX5	-	Snare T9 3	Tambourine Hit
A3	A#3	-	Snare T9 4	Splash Cymbal 2	-	Snare T8 1	Splash Cymbal 2
B3		-	Snare T9 Gate 2	-	-	Snare T9 5	-
C4	C#4	-	Kick T9 4	-	-	Kick T9 1	-
D4	D#4	-	Snare T9 6	-	-	Snare T9 Gate	-
E4		-	Kick T9 1	-	-	Kick T9 2	-
F4	F#4	-	Conga T8 5	Kick T9 3	Bongo H Open 1 F	Kick T9 5	-
G4	G#4	-	Conga T8 4	Snare T9 Rim	Bongo L Open 3 F	Snare T9 Rim	-
A4	A#4	-	Conga Tip	Snare T9 1	Conga H Tip	Snare T9 1	-
B4		-	Conga Open Slap	Clap T9	Conga H SlapOpen	Clap T9	-
C5	C#5	-	Conga Open	Snare T9 2	Conga H Open 2	Snare T9 2	-
D5	D#5	-	Timbale H	Tom T9 1	Timbale H	Tom T9 1	-
E5		-	Timbale L	Hi-Hat Closed T9	Timbale L	Hi-Hat Closed T8	-
F5	F#5	-	Analog Click	Tom T9 2	Agogo H	Tom T9 2	-
G5	G#5	-	Conga T8 1	Hi-Hat Pedal T9	Agogo L	Hi-Hat Pedal T9	-
A5	A#5	-	Cabasa	Tom T9 3	Cabasa	Tom T9 3	-
B5		-	Maracas Slur 2	Hi-Hat Open T9	Maracas Slur 2	Hi-Hat Open T9	-
C6		-	Fx Gun 2	Tom T9 4	Vox Drum L	Tom T9 4	-
		-	Fx Gun 1	Tom T9 5	Vox Drum H	Tom T9 5	-
		-	Scratch H 3	Crash Cymbal T9	Guiro Short	Crash Cymbal T9	-
		-	Scratch Down	Tom T9 6	Guiro Long	Tom T9 6	-
		-	Hi Q 3	Ride Cymbal T9	Claves	Ride Cymbal T9	-
		-	Hi Q 1	China Cymbal 2	Wood Block H	Crash Cymbal 4	-
		-	Hi Q 2	RideCymbal Cup 2	Wood Block L	RideCymbal Cup 2	-
		-	Scratch H 2	Tambourine RX5	Cuica H	Tambourine Hit	-
		-	Scratch L 2	Splash Cymbal 2	Cuica L	Splash Cymbal 2	-
		-	Triangle Mute	Cowbell 1	Triangle Mute	Cowbell 1	-
		-	Triangle Open	Crash Cymbal 4	Triangle Open	Crash Cymbal 1	-
		-	Analog Shaker	Cowbell T8	Analog Shaker	Cowbell T8	-
		-	Sleigh Bells	Ride Cymbal 3	Sleigh Bells	Ride Cymbal 3	-
		-	Wind Chime	-	Wind Chime	-	-
		-	Snare Piccolo	-	Snare Break Roll	-	-
		-	Snare T8 7	-	Noise Burst	-	-
		-	SnareRckRollDist	-	Vox Bell	-	-
		-	Snare Brush Mute	-	Snare R&B 1	-	-
		-	Kick Blip Hard	-	Vox Alk	-	-
		-	Snare Jungle 1	-	Udu High	-	-
		-	Kick Sustain	-	Filter Kick	-	-
		-	-	-	-	-	-
		-	-	-	-	-	-
		-	-	-	-	-	-
		-	-	-	-	-	-

Keyboard Percussion

		HipHop Kit			Drum Machine		
		Preset 1 (UK)	Preset 1 (LK)	Preset 2 (PK)	Preset 1 (UK)	Preset 1 (LK)	Preset 2 (PK)
C1	C#1	-	Surdo Mute	Kick Analog CR	-	Surdo Mute	Kick T9 4
D1	D#1	-	Surdo Open	SnareAnalogSmRim	-	Surdo Open	Snare T9 Rim
E1		-	Hi Q	Snare Clappy	-	Hi Q	Clap T9
F1	F#1	-	Whip Slap	Snare HipHop 2	-	Whip Slap	Snare T9 4
G1	G#1	-	Scratch H	Floor Tom L	-	Scratch H	Tom T9 1
A1	A#1	-	Scratch L	Hi-HatClosed Hip	-	Scratch L	Hi-Hat Closed T9
B1		-	Hi-HatClosedT8 2	Low Tom	-	Snare Drum&Bass1	Tom T9 2
C2	C#2	-	Tom T8 3	Hi-Hat Pedal Hip	-	Kick Break 2	Hi-Hat Pedal T9
D2	D#2	-	Hi-Hat Open T8 2	Mid Tom L	-	Snare Distortion	Tom T9 3
E2		-	Tom T8 6	Hi-Hat Open Hip	-	Kick Tek Power	Hi-Hat Open T9
F2	F#2	-	Crash T8	High Tom	-	KickDistortionRM	Tom T9 4
G2	G#2	-	Triangle Mute	Ride Cymbal 3	-	BassDrumHardLong	Tom T9 5
A2	A#2	-	Triangle Open	Crash Cymbal 3	-	BassDrumTekPower	Crash Cymbal T9
B2		-	Wind Chime	Shaker 2	-	Bass Drum Dist 5	Conga T8 1
C3	C#3	-	TambourineLight2	ScratchBDForward	-	Bass Drum Dist 3	Ride Cymbal T9
D3	D#3	-	TambourineLight1	ScratchBDReverse	-	Bass Drum Dist 1	Conga T8 2
E3		-	Kick HipHop 9	Kick HipHop 2	-	BD Drum & Bass 1	Analog Click
F3	F#3	-	Hi-HatClosed Tek	SnareHipHopRim 2	-	Bass Drum Blip	Claves T8 1
G3	G#3	-	Kick Gate	HipHop Clap 2	-	BassDrumAnalogSm	Maracas T8
A3	A#3	-	Hi-HatOpen Lo-Fi		-	Kick T8 2	
B3		-	KickGranCasaOpen		-	Kick T8 3	
C4	C#4	-	Hi-HatReverseD&B		-	Kick T9 HD 3	
D4	D#4	-	Kick HipHop 1		-	Kick T9 2	
E4		-	Kick HipHop 3	Kick Analog CR	Snare T8 1	Kick T9 4	
F4	F#4	-	SnareHipHopRim 3	SnareAnalogSmRim	Snare T8 2	Snare T9 Rim	
G4	G#4	-	Snare HipHop 5	Snare HipHop 1	Snare T8 3	Snare T9 1	
A4	A#4	-	Electric Clap 1	Snare Clappy	Snare Analog CR	Clap T9	
B4		-	Handbell H	Snare HipHop 2	Snare Jungle 1	Snare T9 4	
C5	C#5	-	Kick HipHop 4	Floor Tom L	Snare Drum&Bass2	Tom T9 1	
D5	D#5	-	HipHop Clap 3	Hi-HatClosed Hip	Snare Hip 1	Hi-Hat Closed T9	
E5		-	HipHop Snap 2	Low Tom	Snare R&B 1	Tom T9 2	
F5	F#5	-	SnareHipHopRim 5	Hi-Hat Pedal Hip	Snare R&B 2	Hi-Hat Pedal T9	
G5	G#5	-	HipHop flex 1	Mid Tom L	Snare Hip 1	Tom T9 3	
A5	A#5	-	HipHop flex 2	Hi-Hat Open Hip	Snare Wood	Hi-Hat Open T9	
B5		-	Shaker 2	High Tom	Snare Timbre	Tom T9 4	
C6		-	Kick HipHop 5	Ride Cymbal 3	Hi-HatClosedT8 1	Tom T9 5	
		-	SnareHipHopRim 4	Crash Cymbal 3	Hi-Hat Open T8 1	Crash Cymbal T9	
		-	Snare HipHop 6	Shaker 2	Hi-HatClosedT8 2	Conga T8 1	
		-	Snare HipHop 11	ScratchBDForward	Hi-Hat Open T8 2	Ride Cymbal T9	
		-	Kick HipHop 10	ScratchBDReverse	Hi-Hat Pedal Aco	Conga T8 2	
		-	Snare HipHop 7	Kick HipHop 2	Hi-HatClosed Aco	Analog Click	
		-	HipHop Clap 5	SnareHipHopRim 2	Hi-Hat Open Aco	Claves T8 1	
		-	Conga H Tip	HipHop Clap 2	Hi-HatClosedLoFi	Maracas T8	
		-	Conga H Heel	HipHop Snap 1	Hi-HatOpen Lo-Fi	TambourineAna CR	
		-	Conga H Open	Snare HipHop 3	Hi-HatClosed Syn	Analog Shaker	
		-	Conga L Open 1	Electric Clap 2	Hi-Hat Open Syn	Cowbell T8	
		-	Conga L Open 2	Kick Hip Deep	Analog Shaker 1	CowbellAnalog CR	
		-	Kick HipHop 8	-	Tambourine RX5 2	-	
		-	HipHop Clap 6		Tambourine 1 Hit		
		-	Snare T8 1		Electric Cowbell		
		-	Snare T8 1 H		Conga T8 3		
		-	HipHop Clap 7		ElectricTriangle		
		-	Tom T8 1		Claves T8 2		
		-	Hi-HatClosedT8 2		Analog Shaker 2		
		-	Tom T8 2		Electric Clap 1		
		-	-		-		
		-	-		-		
		-	-		-		
		-	-		-		

		Break Kit			SFX Kit 1/Live! SFX Kit 1		
		Preset 1 (UK)	Preset 1 (LK)	Preset 2 (PK)	Preset 1 (UK)	Preset 1 (LK)	Preset 2 (PK)
C1	C#1	-	Surdo Mute	Kick Break 1	-	-	Cutting Noise 1
D1	D#1	-	Surdo Open	Snare Hip Rim 1	-	-	Cutting Noise 2
E1		-	Hi Q	Snare Break 3	-	-	-
F1	F#1	-	Whip Slap	Snare Break 1	-	-	String Slap
G1	G#1	-	Scratch H	Snare Break 2	-	-	-
A1	A#1	-	Scratch L	Tom Break 1	-	-	-
B1		-	Finger Snap	HHClosedRockSoft	-	-	-
C2	C#2	-	Snare Break 8	Tom Break 2	-	-	-
D2	D#2	-	Snare Break 9	Hi-Hat PedalRock	-	-	-
E2		-	Hi-HatClosedBrk1	Tom Break 3	-	-	-
F2	F#2	-	Hi-HatClosedBrk2	HH HalfOpen Rock	-	-	-
G2	G#2	-	Kick Break Deep	Tom Break 4	-	-	-
A2	A#2	-	Snare Hip	Tom Break 5	-	-	-
B2		-	Snare Lo-Fi	Crash Cymbal 1	-	-	-
C3	C#3	-	Snare Clappy	Tom Break 6	-	-	-
D3	D#3	-	Snare LdwH Mono	Ride Cymbal 3	-	-	-
E3		-	Snare Rock Roll	China Cymbal 2	-	-	Flute Key Click
F3	F#3	-	Snare Gate 1	RideCymbal Cup 2	-	-	-
G3	G#3	-	Snare Mid	Tambourine 1 Hit	-	-	-
A3	A#3	-	Snare Break Rim	Splash Cymbal 2	-	-	-
B3		-	Kick Break Heavy	-	-	-	-
C4	C#4	-	Snare Hip Rim 4	-	-	-	-
D4	D#4	-	Kick Break 2	-	-	-	-
E4		-	Bongo H	Kick Break 1	-	-	Cutting Noise 1
F4	F#4	-	Bongo L	Snare Hip Rim 1	-	-	Cutting Noise 2
G4	G#4	-	Conga H Tip	Snare Break 3	-	-	-
A4	A#4	-	Conga H OpenSlap	Snare Break 1	-	-	String Slap
B4		-	Conga H Open	Snare Break 2	-	-	-
C5	C#5	-	Bongo 2 H	Tom Break 1	-	-	-
D5	D#5	-	Bongo 2 L	HHClosedRockSoft	-	-	-
E5		-	Conga Open	Tom Break 2	-	-	-
F5	F#5	-	Agogo L	Hi-Hat PedalRock	Shower	-	-
G5	G#5	-	Cabasa	Tom Break 3	Thunder	-	-
A5	A#5	-	Maracas Slur	HH HalfOpen Rock	Wind	-	-
B5		-	Timbale H	Tom Break 4	Stream	-	-
C6		-	Timbale L	Tom Break 5	Bubble	-	-
		-	Scratch H 3	Crash Cymbal 1	Feed	-	-
		-	Scratch Down	Tom Break 6	-	-	-
		-	Claves	Ride Cymbal 3	-	-	-
		-	Wood Block H	China Cymbal 2	-	-	Flute Key Click
		-	Wood Block L	RideCymbal Cup 2	-	-	-
		-	Scratch H 2	Tambourine 1 Hit	-	-	-
		-	Scratch L 2	Splash Cymbal 2	-	-	-
		-	Triangle Mute	Cowbell 1	-	-	-
		-	Triangle Open	Crash Cymbal 2	-	-	-
		-	Kick Break 3	Cowbell RX11	-	-	-
		-	Kick Break 4	Ride Cymbal 2	-	-	-
		-	Kick Break 5	-	Dog	-	-
		-	Kick Break 6	-	Horse	-	-
		-	Kick Break 7	-	Bird Tweet	-	-
		-	Hi-HatClosedBrk3	-	-	-	-
		-	Snare Break 4	-	-	-	-
		-	Snare Break 5	-	-	-	-
		-	Snare Break 6	-	Ghost	-	-
		-	Snare Break 7	-	Maou	-	-
		-	-	-	-	-	-
		-	-	-	-	-	-
		-	-	-	-	-	-
		-	-	-	-	-	-
		-	-	-	-	-	-
		-	-	-	-	-	-

Keyboard Percussion

		Wonderland Kit			PopLatin Kit		
		Preset 1 (UK)	Preset 1 (LK)	Preset 2 (PK)	Preset 1 (UK)	Preset 1 (LK)	Preset 2 (PK)
C1	C#1		Laser Beam	Thunder		-	Bongo H Open 1 f
D1	D#1		Laser Shot	Horse		Cajon Low	Bongo H Open 3 f
E1			Water Phone	Bass Drum		Cajon Slap	Bongo H Rim
F1	F#1		Bubble	Footstep		Cajon Tip	Bongo H Tip
G1	G#1		Puddle	Snare		Claves High	Bongo H Heel
A1	A#1		Thunder	Snare Roll		Claves Low	Bongo H Slap
B1			Shower	Footstep		Hand Clap	Bongo L Open 1 f
C2	C#2		Beach	Lion		-	Bongo L Open 3 f
D2	D#2		Stream	Footstep		Finger Snap	Bongo L Rim
E2			Footstep	Oxen		Castanet	Bongo L Tip
F2	F#2		Door Squeak	Footstep		Conga H Tip	Bongo L Heel
G2	G#2		Door Slam	Door Slam		Conga H Heel	Bongo L Slap
A2	A#2		Bass Drum	Bass Drum	Big Clock	-	Conga H Open
B2			Gran Cassa	Gran Cassa	Footstep	-	Conga H Mute
C3	C#3		Tom 2	Tom 2	Starship	-	Conga H SlapOpen
D3	D#3		Tom 1	Tom 1	Footstep	-	Conga H Slap
E3			Snare	Snare	Train	-	Conga H SlapMute
F3	F#3		Snare Roll	Snare Roll	Car Crash	-	Conga L Tip
G3	G#3		Hi-Hat Closed	Hi-Hat Closed	Footstep	-	Conga L Heel
A3	A#3		Cymbal	Cymbal	Puddle	-	Conga L Open
B3			Hi-Hat Open	Hi-Hat Open		-	Conga L Mute
C4	C#4		Tambourine	Tambourine		-	Conga L SlapOpen
D4	D#4		Finger Snap	Finger Snap		-	Conga L Slap
E4			Castanet	Castanet		-	Conga L Slide
F4	F#4		Triangle Mute	Triangle Mute		Cowbell Top	Bongo H Open 1 f
G4	G#4		Wood Block L	Wood Block L		Cowbell 1	Bongo H Open 3 f
A4	A#4		Triangle Open	Triangle Open		Cowbell 2	Bongo H Rim
B4			Wood Block H	Wood Block H		Cowbell 3	Bongo H Tip
C5	C#5		Hand Clap	Hand Clap		Guiro Short	Bongo H Heel
D5	D#5		Jingle Bells	Jingle Bells		Guiro Long	Bongo H Slap
E5			Bell Tree	Bell Tree		Metal Guiro Short	Bongo L Open 1 f
F5	F#5		Alarm Bell	Alarm Bell		Metal Guiro Long	Bongo L Open 3 f
G5	G#5		Train	Train		Tambourine	Bongo L Rim
A5	A#5		Horn 1	Horn 1		Tambourim Open	Bongo L Tip
B5			Horn 2	Horn 2		Tambourim Mute	Bongo L Heel
C6			Siren	Siren		Tambourim Tip	Bongo L Slap
			CarEngn Ignition	CarEngn Ignition		Maracas	Timbale L
			Car Crash	Car Crash		Shaker	-
			Helicopter	Helicopter		Cabasa	-
			Starship	Starship		Cuica Mute	-
			Sheep	Sheep		Cuica Open	-
			Goat	Goat		Cowbell High 1	Paila L
			Oxen	Oxen		Cowbell High 2	Timbale H
			Whinny	Whinny		Shekere	-
			Horse	Horse		Shekere Tone	-
			Lion	Lion		Triangle Mute	-
			Dog	Dog		Triangle Open	-
			Cat	Cat		-	Paila H
			Hen	Hen		Wind Chime	-
			Owl			-	-
			Insects			-	-
			Frog			-	-
			Tweet 1			-	-
			Tweet 2			-	-
			Cuckoo Clock			-	-
			Big Clock			-	-
			Bell			-	-
			Telephone			-	-
			Camera			-	-
			Gnaw			-	-
			Applause			-	-

		China Kit			OrchestraPerc		
		Preset 1 (UK)	Preset 1 (LK)	Preset 2 (PK)	Preset 1 (UK)	Preset 1 (LK)	Preset 2 (PK)
C1	C#1	-	-	Luo High 1	-	-	Snare Ensemble
D1	D#1	-	-	Gong Batter	-	Symphonic Gong 1	Sus Cym 1 Roll S
E1		-	-	Jin Luo	-	Symphonic Gong L	Sus Cymbal 1
F1	F#1	-	-	Luo High 2	-	Symphonic Gong 2	Sus Cym 2 Roll L
G1	G#1	-	-	Luo Mid-Low	-	Timpani E	Sus Cymbal 2
A1	A#1	-	-	Luo	-	Timpani F	Concert Tom 5
B1		-	-	Jin Luo Low	-	Timpani F#	OrchCymbal 1 ckd
C2	C#2	-	-	Da Cha 1	-	Timpani G	Concert Tom 4
D2	D#2	-	-	Da Cha Effect	-	Timpani G#	Orch Cymbal 1
E2		-	-	Zhongcha	-	Timpani A	Concert Tom 3
F2	F#2	-	-	Xiaocha Effect	-	Timpani A#	Orch Cymbal 2
G2	G#2	-	-	Da Cha 2	-	Timpani B	Concert Tom 2
A2	A#2	-	-	Da Gu mp	-	Timpani C	Concert Tom 1
B2		-	-	Da Gu Rim	-	Timpani C#	Finger Cymbal
C3	C#3	-	-	Da Gu f	-	Timpani D	Gong
D3	D#3	-	-	Da Gu Hand	-	Timpani D#	Ride Cymbal Tip
E3		-	-	Da Gu Roll	-	Timpani High E	China Cymbal
F3	F#3	-	-	Pai Gu 4	-	Gran Cassa Hard	Ride Cymbal Cup
G3	G#3	-	-	Pai Gu 4 High	-	Gran Cassa Soft	Tambourine
A3	A#3	-	-	Pai Gu 3	-	Gran Cassa Hit	Splash Cymbal
B3		-	-	Pai Gu 3 High	-	Gran Cassa Cresc	
C4	C#4	-	-	Pai Gu 2	-	ConcertSnareDrum	
D4	D#4	-	-	Pai Gu 2 High	-	Snare Roll	
E4		-	-	Pai Gu 1	-	Snare Drum Light	
F4	F#4	-	-	Ban	-	Bongo H Stick	Snare Ensemble
G4	G#4	-	-	Bangu Roll	-	Bongo L Stick	Sus Cym 1 Roll S
A4	A#4	-	-	ChineseOperaVo 1	-	Conga H Stick	Sus Cymbal 1
B4		-	-	ChineseOperaVo 2	-	Conga L Stick	Sus Cym 2 Roll L
C5	C#5	-	-	ChineseOperaVo 3	-	Whip	Sus Cymbal 2
D5	D#5	-	-	Yunluo F	-	Rotating Tom 5	Concert Tom 5
E5		-	-	Yunluo F#	-	Tubular Bell L	OrchCymbal 1 ckd
F5	F#5	-	-	Yunluo G	-	Rotating Tom 4	Concert Tom 4
G5	G#5	-	-	Yunluo G#	-	Tubular Bell M	Orch Cymbal 1
A5	A#5	-	-	Yunluo A	-	Rotating Tom 3	Concert Tom 3
B5		-	-	Yunluo A#	-	Tubular Bell H	Orch Cymbal 2
C6		-	-	Yunluo B	-	Rotating Tom 2	Concert Tom 2
		-	-	Yunluo C	-	Rotating Tom 1	Concert Tom 1
		-	-	Yunluo C#	-	Temple Block H	Finger Cymbal
		-	-	Yunluo D	-	Temple Block L	Gong
		-	-	Yunluo D#	-	Claves	Ride Cymbal Tip
		-	-	Yunluo E	-	Wood Block H	China Cymbal
		-	-	Yunluo High F	-	Wood Block L	Ride Cymbal Cup
		-	-	Yunluo High F#	-	Anveil	Tambourine
		-	-	Yunluo High G	-	Triangle Roll	Splash Cymbal
		-	-	Yunluo High G#	-	Triangle Mute	Cowbell
		-	-	Yunluo High A	-	Triangle Open	Jingle Ring
		-	-	Yunluo High A#	-	Bell Tree	Castanet Roll
		-	-	Yunluo High B	-	Sleigh Bells	Table Castanet
		-	-	Yunluo High C	-	Wind Chime	-
		-	-	-	-	-	-
		-	-	-	-	-	-
		-	-	-	-	-	-
		-	-	-	-	-	-
		-	-	-	-	-	-
		-	-	-	-	-	-
		-	-	-	-	-	-
		-	-	-	-	-	-
		-	-	-	-	-	-
		-	-	-	-	-	-
		-	-	-	-	-	-

Creating a User Keyboard Percussion Kit

You can create your own original Keyboard Percussion kit by assigning specific drum/percussion sounds to the notes on the keyboard. To do this, assign your desired Kit (pages 85 – 94) to a User Keyboard Percussion (any of User 1 – 40), then assign each desired drum/percussion sound to any key or pedal. The created User Keyboard Percussion kit can be called up via the KEYBOARD PERCUSSION [1] or [2] button. In the instructions below, drum sounds are assigned to User 1 and called up with the KEYBOARD PERCUSSION [1] button.

NOTE

By default, the same data as the Preset 1 – 2 of the EL Kit is stored to User Keyboard Percussion 1 and 2.

- 1 **Turn on the Keyboard Percussion function by pressing the KEYBOARD PERCUSSION [1] button.**

The K.B.P. display appears.

- 2 **Press [USER 1] on the display.**

This procedure assigns User 1 to the KEYBOARD PERCUSSION [1] button.

This lets you call up the User 1 settings the next time you press the [1] button.

- 3 **Press the [ASSIGN] button at the right top on the display to call up the ASSIGN page.**

- 4 **Press the [KIT CHANGE] button at the center on the display to call up the Kit list of the Keyboard Percussion, then select the desired kit.**

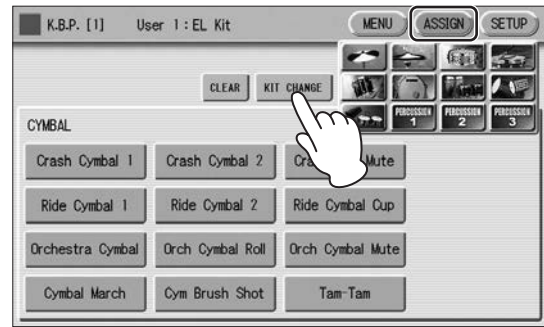

- 5 **Select the desired drum instrument that you wish to assign to a key.**

Select the desired drum instrument category with the category buttons in the display. The drum instrument menu of the selected category appears.

Drum Instrument Category

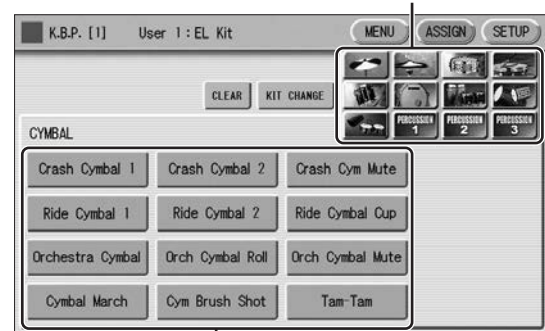

Drum Instrument Menu

Reference page

- Kit Assign List (page 85)

6 Assign an instrument to a particular key or pedal by simultaneously holding down the desired instrument name in the display and pressing the key (or pedal) to which the instrument is to be assigned.

The key to which the instrument is to be assigned

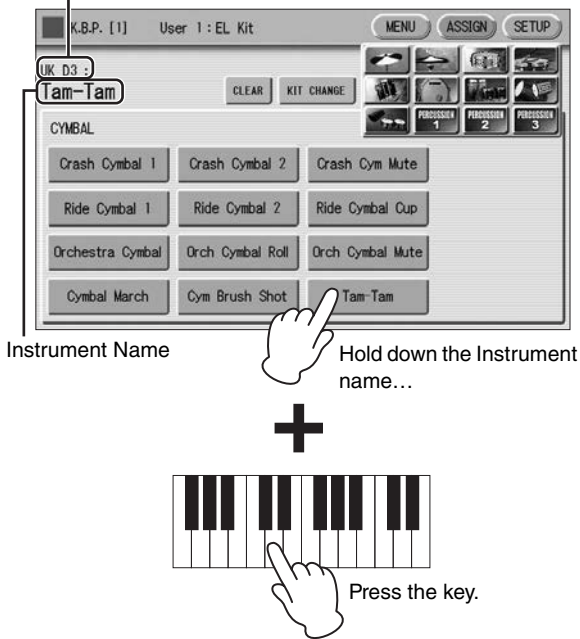

When the assignment is complete, the key name and instrument name is displayed at the top of the display. The assignments are saved to the User memory selected in step 2 (in this example, User 1).

7 Repeat the operation steps above as necessary to construct your own User Keyboard Percussion set.

8 From the Menu page of Keyboard Percussion, select the User number which you wish to use for your performance.

When you select “User 5” on the K.B.P. [1] page for example, pressing the KEYBOARD PERCUSSION [1] button will call up the User 5 of the Keyboard Percussion.

NOTE

The User Keyboard Percussion data cannot be stored to Registration Memory; only the on/off status of the [1]/[2] buttons and which Keyboard Percussion kit (from Preset 1 – 2 and User 1 – 40) is selected can be stored there. When you want to save the User Keyboard Percussion data together with the current Registration Memory data, execute the Save operation to the USB flash drive (page 118). All 40 User Keyboard Percussion kits can be saved for each Unit separately.

To erase one instrument:

Simultaneously hold down the [CLEAR] button in the display (ASSIGN Page) and press the key (or pedal) corresponding to the instrument you wish to erase.

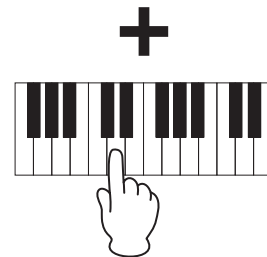

NOTICE

The Keyboard Percussion setting you have created is automatically saved when you switch to another display. While data is being saved, the square at the top left of the display turns light blue for a few seconds. Do not turn the power off while the Keyboard Percussion settings are being saved.

To erase all instruments:

You can clear all assignments using the [CLEAR] button in the display (ASSIGN Page).

1 Press, then release the [CLEAR] button.
The following display appears, prompting confirmation of the operation.



2 Press [CLEAR] in the display to erase all data. When [CLEAR] is selected, a “Completed” message momentarily appears on the display.

Press [CANCEL] in the display to abort the operation.

Copying the Keyboard Percussion settings

You can copy the Preset Keyboard Percussion to one of the User locations, or copy from one User location to another. In the instructions below, Preset 1 is copied to User 1.

- 1 Press the **KEYBOARD PERCUSSION [1]** button to copy Preset 1.

To copy Preset 1, select the [1] button; to copy Preset 2, select the [2] button.

To copy either User location, select button [1] or [2].

- 2 Within the Menu buttons, select the User location as the destination — for example, User 1.

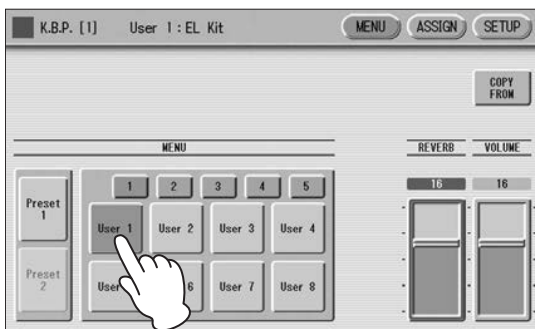

- 3 Press the **[COPY FROM]** button in the display.

A list appears, letting you select the copy source location.

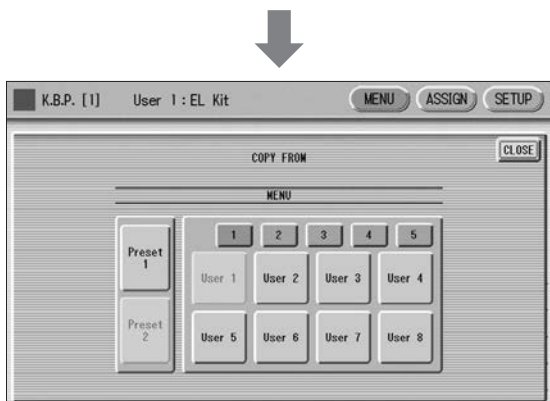
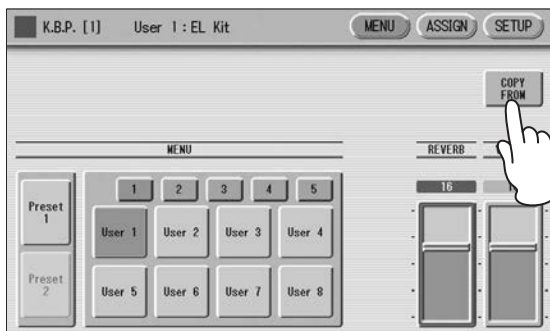

- 4 Select the copy source (Preset 1 here) from the list.

A message appears, prompting confirmation of the operation.

- 5 Press the **[COPY]** button in the display to copy Preset 1. When **[COPY]** is selected, a “Completed” message momentarily appears in the display.

Press the **[CANCEL]** button in the display to abort the operation.

Detailed settings for each percussion instrument

You can independently adjust the settings of pan, pitch, reverb and volume for each instrument. The settings here are system settings that cannot be memorized to Registration memory.

- 1 Turn off the volume of the relevant keyboard (the keyboard to which the instrument to be changed is assigned).

- 2 Press the **[SETUP]** button at the top right of the K.B.P. display to call up the SETUP Page.

- 3 Press the appropriate key (the key to which the instrument to be changed is assigned).

The selected instrument’s name is shown on the display and you can change its settings.

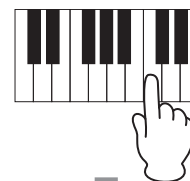

The name of the selected instrument

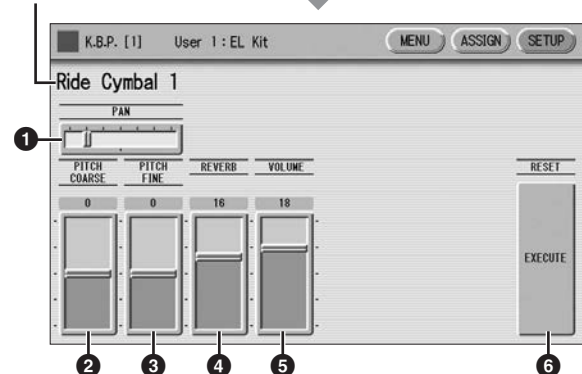

① PAN

Determines the position of the currently selected instrument in the stereo image. Seven pan positions are available.

② PITCH COARSE

Adjusts the pitch of the currently selected instrument by 100 cents.

Range: -64 – +63

③ PITCH FINE

Adjusts the pitch of the currently selected instrument by one cent, allowing more detailed tuning of the instrument than PITCH COARSE (②).

Range: -64 – +63

④ REVERB

Determines the amount of reverb applied to the currently selected instrument.

Range: 0 – 24

⑤ VOLUME

Determines the volume of the currently selected instrument.

Range: 0 – 24

⑥ RESET

Initializes settings such as pan, pitch, and reverb to their default values.

Pressing the [EXECUTE] button calls up the following display, prompting confirmation of the operation.



Press the [EXECUTE] button in the display to restore (initialize) the default settings.

When [EXECUTE] is selected, a “Complete” message momentarily appears on the display.

Press the [CANCEL] button in the display to abort the operation.

Kit Assign list

EL Kit

CYMBAL

- Crash Cymbal 1
- Crash Cymbal 2
- Crash Cym Mute
- Ride Cymbal 1
- Ride Cymbal 2
- Ride Cymbal Cup
- Orch Cymbal Roll
- Orch Cymbal Mute
- Cymbal March
- Cym Brush Shot
- Tam-Tam

HI-HAT

- Hi-Hat Open
- Hi-Hat Closed
- Hi-Hat Pedal 1
- Hi-Hat Pedal 2
- Analog HH Open
- Analog HH Closed

SNARE DRUM

- Snare Drum Light
- Snare Drum Heavy
- Snare Drum Rim 1
- Snare Drum Rim 2
- SD Accent 1
- SD Accent 2
- SD Reverb 1
- SD Reverb 2
- Synth Snare Drum
- Orch Snare Drum
- Snare Drum Roll
- Analog SD

SNARE BRUSH

- SD Brush Shot 1
- SD Brush Shot 2
- SD Brush Roll

TOM

- Tom 1
- Tom 2
- Tom 3
- Tom 4
- Tom Brush Shot 1
- Tom Brush Shot 2
- Tom Brush Shot 3
- Tom Brush Shot 4
- Synth Tom 1
- Synth Tom 2
- Synth Tom 3

BASS DRUM

- Bass Drum Light
- Bass Drum Heavy
- Bass Drum Attack
- Synth Bass Drum
- Bass Drum March
- Concert BD
- Analog BD Short
- Analog BD Long

CONGA/BONGO

- Conga High
- Conga Low
- Conga Slap
- Conga Muff
- Conga Slide
- Bongo High

- Bongo Low
- Bongo Slap
- Bongo Mute

CUICA/SURDO

- Cuica High
- Cuica Middle
- Cuica Low
- Tamborim Open
- Tamborim Mute
- Surdo Open
- Surdo Mute
- Surdo Rim
- Surdo Muff

TIMBALES/COWBELL

- Timbale 1 High
- Timbale 1 Low
- Timbale 2 High
- Timbale 2 Low
- Timbale 3 High
- Timbale 3 Low
- Timbale 4 High
- Timbale 4 Low
- Cowbell 1
- Cowbell 2
- Cowbell 3
- Cowbell 4

PERCUSSION 1

- Cabasa
- Shaker
- Maracas High
- Maracas Low
- Guiro Short
- Guiro Long
- Wood Block High
- Wood Block Mid
- Wood Block Low
- Claves
- Castanet
- Vibraslap

PERCUSSION 2

- Agogo High
- Agogo Low
- Triangle Open
- Triangle Mute
- Wind Chime Down
- Wind Chime Up
- Tambourine
- Pandeiro
- Bells
- Hand Claps
- Finger Snap
- Scratch
- Noise Percussion

PERCUSSION 3

- Kotsuzumi 1
- Kotsuzumi 2
- Kotsuzumi 3
- Kotsuzumi 4
- Ohtsuzumi 1
- Ohtsuzumi 2
- Taiko 1
- Taiko 2
- Ohdaiko 1
- Ohdaiko 2
- Kakegoe 1
- Kakegoe 2
- Kakegoe 3

Standard Kit 1

CYMBAL

- Crash Cymbal 1
- Crash Cymbal 2
- Splash Cymbal
- Chinese Cymbal
- Ride Cymbal 1
- Ride Cymbal 2
- Ride Cymbal Cup
- Hi-Hat Open
- Hi-Hat Closed
- Hi-Hat Pedal

SNARE DRUM

- Snare
- Snare Tight
- Snare Soft
- Snare Roll
- Side Stick
- Open Rim Shot
- Brush Tap
- Brush Slap
- Brush Swirl
- Brush Tap Swirl

TOM

- Floor Tom L
- Floor Tom H
- Low Tom
- Mid Tom L
- Mid Tom H
- High Tom

BASS DRUM

- Kick
- Kick Tight
- Kick Soft

PERCUSSION 1

- Conga H Open
- Conga L
- Conga H Mute
- Bongo H
- Bongo L
- Timbale H
- Timbale L
- Cowbell
- Claves
- Guiro Long
- Guiro Short
- Maracas
- Vibraslap

PERCUSSION 2

- Surdo Mute
- Surdo Open
- Cuica Mute
- Cuica Open
- Cabasa
- Shaker
- Agogo H
- Agogo L
- Samba Whistle H
- Samba Whistle L

PERCUSSION 3

- Tambourine
- Castanet
- Jingle Bells
- Bell Tree
- Triangle Open
- Triangle Mute

- Wood Block H
- Wood Block L
- Sticks
- Whip Slap
- Finger Snap
- Hand Clap

PERCUSSION 4

- Hi Q
- Click Noise
- Scratch H
- Scratch L
- Seq Click L
- Seq Click H
- Metronome Click
- Metronome Bell

Standard Kit 2

CYMBAL

- Crash Cymbal 1
- Crash Cymbal 2
- Splash Cymbal
- Chinese Cymbal
- Ride Cymbal 1
- Ride Cymbal 2
- Ride Cymbal Cup
- Hi-Hat Open
- Hi-Hat Closed
- Hi-Hat Pedal

SNARE DRUM

- Snare Short
- Snare Tight H
- Snare Soft 2
- Snare Roll
- Side Stick Light
- Open Rim Shot H
- Brush Tap
- Brush Slap
- Brush Swirl
- Brush Tap Swirl

TOM

- Floor Tom L
- Floor Tom H
- Low Tom
- Mid Tom L
- Mid Tom H
- High Tom

BASS DRUM

- Kick Short
- Kick Tight
- Kick Soft

PERCUSSION 1

- Conga H Open
- Conga L
- Conga H Mute
- Bongo H
- Bongo L
- Timbale H
- Timbale L
- Cowbell
- Claves
- Guiro Long
- Guiro Short
- Maracas
- Vibraslap

PERCUSSION 2

- Surdo Mute
- Surdo Open
- Cuica Mute
- Cuica Open
- Cabasa
- Shaker
- Agogo H
- Agogo L
- Samba Whistle H
- Samba Whistle L

PERCUSSION 3

- Tambourine
- Castanet
- Jingle Bells
- Bell Tree
- Triangle Open
- Triangle Mute
- Wood Block H
- Wood Block L
- Sticks
- Whip Slap
- Finger Snap
- Hand Clap

PERCUSSION 4

- Hi Q
- Click Noise
- Scratch H
- Scratch L
- Seq Click L
- Seq Click H
- Metronome Click
- Metronome Bell

Hit Kit

CYMBAL

- Crash Cymbal 1
- Crash Cymbal 2
- Splash Cymbal
- Chinese Cymbal
- Ride Cymbal 1
- Ride Cymbal 2
- Ride Cymbal Cup
- Hi-Hat Open 2
- Hi-Hat Closed 2
- Hi-Hat Pedal 2

SNARE DRUM

- Snare Ambient
- Snare Tight 2
- Snare Electro
- Snare Roll
- Stick Ambient
- Snare Pitched
- Brush Tap
- Brush Slap
- Brush Swirl
- Brush Tap Swirl

TOM

- Hybrid Tom 1
- Hybrid Tom 2
- Hybrid Tom 3
- Hybrid Tom 4
- Hybrid Tom 5
- Hybrid Tom 6

BASS DRUM

- Kick Tight H
- Kick Wet
- Kick Tight L

PERCUSSION 1

- Conga H Open
- Conga L
- Conga H Mute
- Bongo H
- Bongo L
- Timbale H
- Timbale L
- Cowbell
- Claves
- Guiro Long
- Guiro Short
- Maracas
- Vibraslap

PERCUSSION 2

- Surdo Mute
- Surdo Open
- Cuica Mute
- Cuica Open
- Cabasa
- Shaker
- Agogo H
- Agogo L
- Samba Whistle H
- Samba Whistle L

PERCUSSION 3

- Tambourine Light
- Castanet
- Jingle Bells
- Bell Tree
- Triangle Open
- Triangle Mute
- Wood Block H
- Wood Block L
- Sticks
- Whip Slap
- Finger Snap
- Hand Clap

PERCUSSION 4

- Hi Q
- Click Noise
- Scratch H
- Scratch L
- Seq Click L
- Seq Click H
- Metronome Click
- Metronome Bell

Room Kit

CYMBAL

- Crash Cymbal 1
- Crash Cymbal 2
- Splash Cymbal
- Chinese Cymbal
- Ride Cymbal 1
- Ride Cymbal 2
- Ride Cymbal Cup
- Hi-Hat Open
- Hi-Hat Closed
- Hi-Hat Pedal

SNARE DRUM

- Snare Snappy
- Snare Tight Snap
- Snare Soft
- Snare Roll
- Side Stick
- Open Rim Shot
- Brush Tap
- Brush Slap
- Brush Swirl
- Brush Tap Swirl

TOM

- Tom Room 1
- Tom Room 2
- Tom Room 3
- Tom Room 4
- Tom Room 5
- Tom Room 6

BASS DRUM

- Kick
- Kick Tight
- Kick Soft

PERCUSSION 1

- Conga H Open
- Conga L
- Conga H Mute
- Bongo H
- Bongo L
- Timbale H
- Timbale L
- Cowbell
- Claves
- Guiro Long
- Guiro Short
- Maracas
- Vibraslap

PERCUSSION 2

- Surdo Mute
- Surdo Open
- Cuica Mute
- Cuica Open
- Cabasa
- Shaker
- Agogo H
- Agogo L
- Samba Whistle H
- Samba Whistle L

PERCUSSION 3

- Tambourine
- Castanet
- Jingle Bells
- Bell Tree
- Triangle Open
- Triangle Mute
- Wood Block H
- Wood Block L
- Sticks
- Whip Slap
- Finger Snap
- Hand Clap

PERCUSSION 4

- Hi Q
- Click Noise
- Scratch H
- Scratch L
- Seq Click L
- Seq Click H
- Metronome Click
- Metronome Bell

Rock Kit

CYMBAL

- Crash Cymbal 1
- Crash Cymbal 2
- Splash Cymbal
- Chinese Cymbal
- Ride Cymbal 1
- Ride Cymbal 2
- Ride Cymbal Cup
- Hi-Hat Open
- Hi-Hat Closed

- Hi-Hat Pedal

SNARE DRUM

- Snare Rock
- Snare Rock Tight
- Snare Noisy
- Snare Roll
- Side Stick
- Open Rim Shot
- Brush Tap
- Brush Slap
- Brush Swirl
- Brush Tap Swirl

TOM

- Tom Rock 1
- Tom Rock 2
- Tom Rock 3
- Tom Rock 4
- Tom Rock 5
- Tom Rock 6

BASS DRUM

- Kick Gate
- Kick 2
- Kick Soft

PERCUSSION 1

- Conga H Open
- Conga L
- Conga H Mute
- Bongo H
- Bongo L
- Timbale H
- Timbale L
- Cowbell
- Claves
- Guiro Long
- Guiro Short
- Maracas
- Vibraslap

PERCUSSION 2

- Surdo Mute
- Surdo Open
- Cuica Mute
- Cuica Open
- Cabasa
- Shaker
- Agogo H
- Agogo L
- Samba Whistle H
- Samba Whistle L

PERCUSSION 3

- Tambourine
- Castanet
- Jingle Bells
- Bell Tree
- Triangle Open
- Triangle Mute
- Wood Block H
- Wood Block L
- Sticks
- Whip Slap
- Finger Snap
- Hand Clap

PERCUSSION 4

- Hi Q
- Click Noise
- Scratch H
- Scratch L
- Seq Click L
- Seq Click H
- Metronome Click
- Metronome Bell

Electro Kit**CYMBAL**

- Crash Cymbal 1
- Crash Cymbal 2
- Splash Cymbal
- Chinese Cymbal
- Ride Cymbal 1
- Ride Cymbal 2
- Ride Cymbal Cup
- Hi-Hat Open
- Hi-Hat Closed
- Hi-Hat Pedal

SNARE DRUM

- Snare Noisy 2
- Snare Noisy 3
- Snare Snap Elec
- Snare Roll
- Side Stick
- Open Rim Shot
- Brush Tap
- Brush Slap
- Brush Swirl
- Reverse Cymbal

TOM

- Tom Electro 1
- Tom Electro 2
- Tom Electro 3
- Tom Electro 4
- Tom Electro 5
- Tom Electro 6

BASS DRUM

- Kick Gate Heavy
- Kick Gate
- Kick 3

PERCUSSION 1

- Conga H Open
- Conga L
- Conga H Mute
- Bongo H
- Bongo L
- Timbale H
- Timbale L
- Cowbell
- Claves
- Guiro Long
- Guiro Short
- Maracas
- Vibraslap

PERCUSSION 2

- Surdo Mute
- Surdo Open
- Scratch H 2
- Scratch L 2
- Cabasa
- Shaker
- Agogo H
- Agogo L
- Samba Whistle H
- Samba Whistle L

PERCUSSION 3

- Tambourine
- Hi Q 2
- Jingle Bells
- Bell Tree
- Triangle Open
- Triangle Mute
- Wood Block H
- Wood Block L
- Sticks
- Whip Slap

- Finger Snap
- Hand Clap

PERCUSSION 4

- Hi Q
- Click Noise
- Scratch H
- Scratch L
- Seq Click L
- Seq Click H
- Metronome Click
- Metronome Bell

Analog Kit**CYMBAL**

- Crash Analog
- Crash Cymbal 2
- Splash Cymbal
- Chinese Cymbal
- Ride Cymbal 1
- Ride Cymbal 2
- Ride Cymbal Cup
- Hat Open Analog
- Hat Close Analog
- Hat Close Anlg 2

SNARE DRUM

- Snare Analog
- Snare Analog 2
- Snare Noisy 4
- Snare Roll
- Side Stick Anlg
- Open Rim Shot
- Brush Tap
- Brush Slap
- Brush Swirl
- Reverse Cymbal

TOM

- Tom Analog 1
- Tom Analog 2
- Tom Analog 3
- Tom Analog 4
- Tom Analog 5
- Tom Analog 6

BASS DRUM

- Kick Analog
- Kick Anlg Short
- Kick 3

PERCUSSION 1

- Conga Analog M
- Conga Analog L
- Conga Analog H
- Bongo H
- Bongo L
- Timbale H
- Timbale L
- Cowbell Analog
- Claves 2
- Guiro Long
- Guiro Short
- Maracas 2
- Vibraslap

PERCUSSION 2

- Surdo Mute
- Surdo Open
- Scratch H 2
- Scratch L 2
- Cabasa
- Shaker
- Agogo H
- Agogo L
- Samba Whistle H

- Samba Whistle L

PERCUSSION 3

- Tambourine
- Hi Q 2
- Jingle Bells
- Bell Tree
- Triangle Open
- Triangle Mute
- Wood Block H
- Wood Block L
- Sticks
- Whip Slap
- Finger Snap
- Hand Clap

PERCUSSION 4

- Hi Q
- Click Noise
- Scratch H
- Scratch L
- Seq Click L
- Seq Click H
- Metronome Click
- Metronome Bell

Dance Kit**CYMBAL**

- Crash Analog
- Crash Cymbal 2
- Splash Cymbal
- Chinese Cymbal
- Ride Cymbal 1
- Ride Analog
- Ride Cymbal Cup
- Hi-Hat Open 3
- Hi-Hat Closed 3
- Hat Close Anlg 3

SNARE DRUM

- Snare Clap
- Snare Dry
- Snare Techno
- Reverse Dance 2
- Side Stick Anlg
- Rim Gate
- Snare Analog 3
- Snare Analog 4
- Vinyl Noise
- Reverse Cymbal

TOM

- Tom Dance 1
- Tom Dance 2
- Tom Dance 3
- Tom Dance 4
- Tom Dance 5
- Tom Dance 6

BASS DRUM

- Kick Techno
- Kick Techno L
- Kick Techno Q

PERCUSSION 1

- Conga Analog M
- Conga Analog L
- Conga Analog H
- Bongo Analog H
- Bongo Analog L
- Timbale H
- Timbale L
- Cowbell Dance
- Claves 2
- Guiro Long
- Guiro Short

- Maracas 2
- Vibraslap Analog

PERCUSSION 2

- Kick Dance 1
- Kick Dance 2
- Dance Breath 1
- Dance Breath 2
- Cabasa
- Shaker
- Agogo H
- Agogo L
- Samba Whistle H
- Samba Whistle L

PERCUSSION 3

- Tambourine Anlg
- Hi Q 2
- Jingle Bells
- Bell Tree
- Triangle Open
- Triangle Mute
- Dance Perc 3
- Dance Perc 4
- Snare Dance 1
- Whip Slap
- Finger Snap
- Dance Clap

PERCUSSION 4

- Hi Q
- Click Noise
- Scratch Dance 1
- Scratch Dance 2
- Dance Perc 2
- Hi Q Dance 1
- Dance Perc 1
- Reverse Dance 1

Jazz Kit**CYMBAL**

- Crash Cymbal 1
- Crash Cymbal 2
- Splash Cymbal
- Chinese Cymbal
- Ride Cymbal 1
- Ride Cymbal 2
- Ride Cymbal Cup
- Hi-Hat Open
- Hi-Hat Closed
- Hi-Hat Pedal

SNARE DRUM

- Snare Jazz L
- Snare Jazz M
- Snare Jazz H
- Snare Roll
- Side Stick Light
- Open Rim Shot
- Brush Tap
- Brush Slap
- Brush Swirl
- Brush Tap Swirl

TOM

- Floor Tom L
- Floor Tom H
- Low Tom
- Mid Tom L
- Mid Tom H
- High Tom

BASS DRUM

- Kick Jazz
- Kick Tight
- Kick Soft

PERCUSSION 1

- Conga H Open
- Conga L
- Conga H Mute
- Bongo H
- Bongo L
- Timbale H
- Timbale L
- Cowbell
- Claves
- Guiro Long
- Guiro Short
- Maracas
- Vibraslap

PERCUSSION 2

- Surdo Mute
- Surdo Open
- Cuica Mute
- Cuica Open
- Cabasa
- Shaker
- Agogo H
- Agogo L
- Samba Whistle H
- Samba Whistle L

PERCUSSION 3

- Tambourine
- Castanet
- Jingle Bells
- Bell Tree
- Triangle Open
- Triangle Mute
- Wood Block H
- Wood Block L
- Sticks
- Whip Slap
- Finger Snap
- Hand Clap

PERCUSSION 4

- Hi Q
- Click Noise
- Scratch H
- Scratch L
- Seq Click L
- Seq Click H
- Metronome Click
- Metronome Bell

Brush Kit

CYMBAL

- Crash Cymbal 1
- Crash Cymbal 2
- Splash Cymbal
- Chinese Cymbal
- Ride Cymbal 1
- Ride Cymbal 2
- Ride Cymbal Cup
- Hi-Hat Open
- Hi-Hat Closed
- Hi-Hat Pedal

SNARE DRUM

- Brush Slap 3
- Brush Tap 2
- Brush Slap 2
- Snare Roll
- Side Stick Light
- Open Rim Shot
- Brush Tap
- Brush Slap
- Brush Swirl
- Brush Tap Swirl

TOM

- Tom Brush 1
- Tom Brush 2
- Tom Brush 3
- Tom Brush 4
- Tom Brush 5
- Tom Brush 6

BASS DRUM

- Kick Jazz
- Kick Tight
- Kick Soft

PERCUSSION 1

- Conga H Open
- Conga L
- Conga H Mute
- Bongo H
- Bongo L
- Timbale H
- Timbale L
- Cowbell
- Claves
- Guiro Long
- Guiro Short
- Maracas
- Vibraslap

PERCUSSION 2

- Surdo Mute
- Surdo Open
- Cuica Mute
- Cuica Open
- Cabasa
- Shaker
- Agogo H
- Agogo L
- Samba Whistle H
- Samba Whistle L

PERCUSSION 3

- Tambourine
- Castanet
- Jingle Bells
- Bell Tree
- Triangle Open
- Triangle Mute
- Wood Block H
- Wood Block L
- Sticks
- Whip Slap
- Finger Snap
- Hand Clap

PERCUSSION 4

- Hi Q
- Click Noise
- Scratch H
- Scratch L
- Seq Click L
- Seq Click H
- Metronome Click
- Metronome Bell

Symphony Kit

CYMBAL

- Hand Cymbal
- Hand Cymbal 2
- Splash Cymbal
- Chinese Cymbal
- Hand Cymbal S
- Hand Cymbal 2 S
- Ride Cymbal Cup
- Hi-Hat Open
- Hi-Hat Closed

- Hi-Hat Pedal

SNARE DRUM

- Band Snare
- Band Snare 2
- Snare Soft
- Snare Roll
- Side Stick
- Open Rim Shot
- Brush Tap
- Brush Slap
- Brush Swirl
- Brush Tap Swirl

TOM

- Floor Tom L
- Floor Tom H
- Low Tom
- Mid Tom L
- Mid Tom H
- High Tom

BASS DRUM

- Gran Cassa Mute
- Gran Cassa
- Kick Soft 2

PERCUSSION 1

- Conga H Open
- Conga L
- Conga H Mute
- Bongo H
- Bongo L
- Timbale H
- Timbale L
- Cowbell
- Claves
- Guiro Long
- Guiro Short
- Maracas
- Vibraslap

PERCUSSION 2

- Surdo Mute
- Surdo Open
- Cuica Mute
- Cuica Open
- Cabasa
- Shaker
- Agogo H
- Agogo L
- Samba Whistle H
- Samba Whistle L

PERCUSSION 3

- Tambourine
- Castanet
- Jingle Bells
- Bell Tree
- Triangle Open
- Triangle Mute
- Wood Block H
- Wood Block L
- Sticks
- Whip Slap
- Finger Snap
- Hand Clap

PERCUSSION 4

- Hi Q
- Click Noise
- Scratch H
- Scratch L
- Seq Click L
- Seq Click H
- Metronome Click
- Metronome Bell

Live!StudioKit

CYMBAL

- Crash Cymbal 1
- Crash Cymbal 2
- Splash Cymbal
- Chinese Cymbal
- Ride Cymbal 1
- Ride Cymbal 2
- Ride Cymbal Cup
- Hi-Hat Open
- Hi-Hat Closed
- Hi-Hat Pedal

SNARE DRUM

- Snare Studio M
- Snare Studio L
- Snare Studio 2
- Snare Roll
- Side Stick
- Open Rim Shot
- Brush Tap
- Brush Slap
- Brush Swirl
- Brush Tap Swirl

TOM

- Floor Tom L
- Floor Tom H
- Low Tom
- Mid Tom L
- Mid Tom H
- High Tom

BASS DRUM

- Kick Studio
- Kick Ambience L
- Kick Ambience H

PERCUSSION 1

- Conga H Open
- Conga L
- Conga H Mute
- Bongo H
- Bongo L
- Timbale H
- Timbale L
- Cowbell
- Claves
- Guiro Long
- Guiro Short
- Maracas
- Vibraslap

PERCUSSION 2

- Surdo Mute
- Surdo Open
- Cuica Mute
- Cuica Open
- Cabasa
- Shaker
- Agogo H
- Agogo L
- Samba Whistle H
- Samba Whistle L

PERCUSSION 3

- Tambourine
- Castanet
- Jingle Bells
- Bell Tree
- Triangle Open
- Triangle Mute
- Wood Block H
- Wood Block L
- Sticks
- Whip Slap

- Finger Snap
- Hand Clap

PERCUSSION 4

- Hi Q
- Click Noise
- Scratch H
- Scratch L
- Seq Click L
- Seq Click H
- Metronome Click
- Metronome Bell

Live!AcousticKit

CYMBAL

- CrashCymbalAco 1
- CrashCymbalAco 2
- SplashCymbal Aco
- China Cymbal Aco
- RideCymbal Aco 1
- RideCymbal Aco 2
- RideCymbalCupAco
- Hi-Hat Open Aco
- Hi-HatClosedAco
- Hi-HatPedal Aco

SNARE DRUM

- Snare Acoustic
- Snare Rough Aco
- Snare Soft Aco
- Snare Roll Aco
- Stick Acoustic
- Rim Acoustic
- Brush Tap
- Brush Slap
- Brush Swirl
- Brush Tap Swirl

TOM

- Tom Acoustic 1
- Tom Acoustic 2
- Tom Acoustic 3
- Tom Acoustic 4
- Tom Acoustic 5
- Tom Acoustic 6

BASS DRUM

- Kick Mute Aco
- Kick Open Aco
- Kick Soft Aco

PERCUSSION 1

- Conga H Open
- Conga L
- Conga H Mute
- Bongo H
- Bongo L
- Timbale H
- Timbale L
- Cowbell
- Claves
- Guiro Long
- Guiro Short
- Maracas
- Vibraslap

PERCUSSION 2

- Surdo Mute
- Surdo Open
- Cuica Mute
- Cuica Open
- Cabasa
- Shaker
- Agogo H
- Agogo L
- Samba Whistle H

- Samba Whistle L

PERCUSSION 3

- Tambourine
- Castanet
- Jingle Bells
- Wind Chime
- Triangle Open
- Triangle Mute
- Wood Block H
- Wood Block L
- Sticks
- Whip Slap
- Finger Snap
- Hand Clap Power

PERCUSSION 4

- Hi Q
- Click Noise
- Scratch H
- Scratch L
- Seq Click L
- Seq Click H
- Metronome Click
- Metronome Bell

Live!PowerKit1

CYMBAL

- CrashCymbalAco 1
- CrashCymbalAco 2
- SplashCymbal Aco
- China Cymbal Aco
- RideCymbal Aco 1
- RideCymbal Aco 2
- RideCymbalCupAco
- Hi-HatOpen Power
- Hi-HatClosePower
- Hi-HatPedalPower

SNARE DRUM

- Snare Power 1
- Snare Rough 1
- SnareSoftPower 1
- Snare Roll
- Side Stick Power
- Open Rim Power 1
- Brush Tap
- Brush Slap
- Brush Swirl
- Brush Tap Swirl

TOM

- Tom Power 1
- Tom Power 2
- Tom Power 3
- Tom Power 4
- Tom Power 5
- Tom Power 6

BASS DRUM

- Kick Power Mute
- Kick Power Open
- Kick Ambient+

PERCUSSION 1

- Conga H Open
- Conga L
- Conga H Mute
- Bongo H
- Bongo L
- Timbale H
- Timbale L
- Cowbell
- Claves
- Guiro Long
- Guiro Short

- Maracas
- Vibraslap

PERCUSSION 2

- Surdo Mute
- Surdo Open
- Cuica Mute
- Cuica Open
- Cabasa
- Shaker
- Agogo H
- Agogo L
- Samba Whistle H
- Samba Whistle L

PERCUSSION 3

- Tambourine
- Castanet
- Jingle Bells
- Wind Chime
- Triangle Open
- Triangle Mute
- Wood Block H
- Wood Block L
- Sticks
- Whip Slap
- Finger Snap
- Hand Clap Power

PERCUSSION 4

- Hi Q
- Click Noise
- Scratch H
- Scratch L
- Seq Click L
- Seq Click H
- Metronome Click
- Metronome Bell

Live!PowerKit2

CYMBAL

- CrashCymbalAco 1
- CrashCymbalAco 2
- SplashCymbal Aco
- China Cymbal Aco
- RideCymbal Aco 1
- RideCymbal Aco 2
- RideCymbalCupAco
- Hi-HatOpen Power
- HH Closed PW Eg
- Hi-HatPedalPower

SNARE DRUM

- Snare Power 2
- Snare Rough 2
- SnareSoftPower 2
- Snare Roll
- Side Stick Power
- Open Rim Power 2
- Brush Tap
- Brush Slap
- Brush Swirl
- Brush Tap Swirl

TOM

- Tom Power 1
- Tom Power 2
- Tom Power 3
- Tom Power 4
- Tom Power 5
- Tom Power 6

BASS DRUM

- Kick Power Mute
- Kick Power Open
- Kick Ambient+

PERCUSSION 1

- Conga H Open
- Conga L
- Conga H Mute
- Bongo H
- Bongo L
- Timbale H
- Timbale L
- Cowbell
- Claves
- Guiro Long
- Guiro Short
- Maracas
- Vibraslap

PERCUSSION 2

- Surdo Mute
- Surdo Open
- Cuica Mute
- Cuica Open
- Cabasa
- Shaker
- Agogo H
- Agogo L
- Samba Whistle H
- Samba Whistle L

PERCUSSION 3

- Tambourine
- Castanet
- Jingle Bells
- Wind Chime
- Triangle Open
- Triangle Mute
- Wood Block H
- Wood Block L
- Sticks
- Whip Slap
- Finger Snap
- Hand Clap Power

PERCUSSION 4

- Hi Q
- Click Noise
- Scratch H
- Scratch L
- Seq Click L
- Seq Click H
- Metronome Click
- Metronome Bell

Live!Rock Kit

CYMBAL

- CrashCymbalAco 1
- CrashCymbalAco 2
- SplashCymbal Aco
- China Cymbal Aco
- RideCymbal Aco 1
- RideCymbal Aco 2
- RideCymbalCupAco
- Hi-Hat Open Rock
- Hi-HatClosedRock
- Hi-HatPedal Rock

SNARE DRUM

- Snare Rock
- Snare Dry Rock
- Snare Soft Rock
- Snare Roll Rock
- Stick Rock
- Rim Rock
- Brush Tap
- Brush Slap
- Brush Swirl
- Brush Tap Swirl

TOM

- Tom Rock 1
- Tom Rock 2
- Tom Rock 3
- Tom Rock 4
- Tom Rock 5
- Tom Rock 6

BASS DRUM

- Kick Rock
- Kick Rock Heavy
- Kick Soft Rock

PERCUSSION 1

- Conga H Open
- Conga L
- Conga H Mute
- Bongo H
- Bongo L
- Timbale H
- Timbale L
- Cowbell
- Claves
- Guiro Long
- Guiro Short
- Maracas
- Vibraslap

PERCUSSION 2

- Surdo Mute
- Surdo Open
- Cuica Mute
- Cuica Open
- Cabasa
- Shaker
- Agogo H
- Agogo L
- Samba Whistle H
- Samba Whistle L

PERCUSSION 3

- Tambourine
- Castanet
- Jingle Bells
- Wind Chime
- Triangle Open
- Triangle Mute
- Wood Block H
- Wood Block L
- Sticks
- Whip Slap
- Finger Snap
- Hand Clap Power

PERCUSSION 4

- Hi Q
- Click Noise
- Scratch H
- Scratch L
- Seq Click L
- Seq Click H
- Metronome Click
- Metronome Bell

Live!Real Drums

CYMBAL

- CrashCymbalReal1
- CrashCymbalReal2
- SplashCymbalReal
- ChinaCymbal Real
- RideCymbalReal 1
- RideCymbalReal 2
- RideCym Cup Real
- Hi-Hat Open Real
- Hi-HatClosedReal

- Hi-Hat PedalReal

SNARE DRUM

- Snare Real 1
- Snare Real 2
- Snare Tight
- Snare Roll Rock
- Stick Real
- Rim Real
- Brush Tap
- Brush Slap
- Brush Tap Swirl

TOM

- Tom Real 1
- Tom Real 2
- Tom Real 3
- Tom Real 4
- Tom Real 5
- Tom Real 6

BASS DRUM

- Kick Real 1
- Kick Real 2
- Kick Genuine

PERCUSSION 1

- Conga H Open
- Conga L
- Conga H Mute
- Bongo H
- Bongo L
- Timbale H
- Timbale L
- Cowbell
- Claves
- Guiro Long
- Guiro Short
- Maracas
- Vibraslap

PERCUSSION 2

- Surdo Mute
- Surdo Open
- Cuica Mute
- Cuica Open
- Cabasa
- Shaker
- Agogo H
- Agogo L
- Samba Whistle H
- Samba Whistle L

PERCUSSION 3

- Tambourine
- Castanet
- Jingle Bells
- Wind Chime
- Triangle Open
- Triangle Mute
- Wood Block H
- Wood Block L
- Sticks
- Whip Slap
- Finger Snap
- Clap Power

PERCUSSION 4

- Hi Q
- Click Noise
- Scratch H
- Scratch L
- Seq Click L
- Seq Click H
- Metronome Click
- Metronome Bell

Live!RealBrushes

CYMBAL

- CrashCymbal RB 1
- CrashCymbal RB 2
- Splash Cymbal RB
- ChinaCymbal RB
- Ride Cymbal RB
- Ride Cup RB 1
- Ride Cup RB 2
- Hi-Hat Open RB
- Hi-Hat Closed RB
- Hi-Hat Pedal RB

SNARE DRUM

- Vintage Slap 1
- Vintage Slap 2
- Vintage Slap 3
- Vintage Slap 4
- Vintage Slap 5
- VintageSlapSwirl
- Vintage Swirl 1
- Vintage Swirl 2
- Vintage Swirl 3
- Vintage TapSwirl
- Vintage Tip
- Stick Brush
- Open Rim Shot RB

TOM

- TomRealBrushes 1
- TomRealBrushes 2
- TomRealBrushes 3
- TomRealBrushes 4
- TomRealBrushes 5
- TomRealBrushes 6

BASS DRUM

- KickJazzAmbience
- Kick Soft H
- Kick Soft L

PERCUSSION 1

- Conga H Open
- Conga L
- Conga H Mute
- Bongo H
- Bongo L
- Timbale H
- Timbale L
- Cowbell
- Claves
- Guiro Long
- Guiro Short
- Maracas
- Vibraslap

PERCUSSION 2

- Surdo Mute
- Surdo Open
- Cuica Mute
- Cuica Open
- Cabasa
- Shaker
- Agogo H
- Agogo L
- Samba Whistle H
- Samba Whistle L

PERCUSSION 3

- Tambourine
- Jingle Bells
- Wind Chime
- Triangle Open
- Triangle Mute
- Wood Block H
- Wood Block L

- Sticks
- Whip Slap
- Finger Snap
- Clap Power

PERCUSSION 4

- Hi Q
- Click Noise
- Scratch H
- Scratch L
- Metronome Bell
- Metronome Click

Analog T8 Kit

CYMBAL

- Crash Cymbal T8
- Crash Cymbal 4
- Splash Cymbal
- China Cymbal 2
- Ride Cymbal T9
- Ride Cymbal 3
- RideCymbal Cup 2
- Hi-Hat Open T8
- Hi-Hat Closed T8
- Hi-Hat Pedal T8

SNARE DRUM 1

- Snare T8 1
- Snare T8 2
- Snare T8 3
- Snare T8 4
- Snare T8 5
- Snare T8 6
- Snare T8 7
- Snare T8 Rim
- Snare Analog CR
- SnareClap Analog
- Snare Break 1
- Snare Garg L
- Snare Fx 1
- Snare Hammer

SNARE DRUM 2

- Snare Hip 1
- Snare Hip 2
- Snare Hip Gate

TOM

- Tom T8 1
- Tom T8 2
- Tom T8 3
- Tom T8 4
- Tom T8 5
- Tom T8 6
- Tom T8 7

BASS DRUM

- Kick T8 1
- Kick T8 2
- Kick T8 3
- Kick T8 4
- T8 Kick Bass
- Kick Slimy
- Kick Blip
- Kick Tek Power
- Kick Fx Hammer
- Kick Zap Hard

PERCUSSION 1

- Conga T8 1
- Conga T8 2
- Conga T8 3
- Conga T8 4
- Conga T8 5
- Timbale H
- Timbale L

- Cowbell T8
- Claves T8
- Glass H
- Glass L
- Maracas T8
- Vibraslap

PERCUSSION 2

- Surdo Mute
- Surdo Open
- Cabasa
- Analog Shaker
- Analog Shaker H
- Analog Shaker L

PERCUSSION 3

- Tambourine RX5
- Sleigh Bells
- Wind Chime
- Triangle Open
- Triangle Mute
- Clap T9
- Whip Slap

PERCUSSION 4

- Hi Q
- Hi Q 1
- Hi Q 2
- Scratch H
- Scratch L
- Scratch H 2
- Scratch L 2
- Fx Gun 1
- Fx Gun 2

Analog T9 Kit

CYMBAL

- Crash Cymbal T9
- Splash Cymbal 2
- Crash Cymbal 4
- China Cymbal 2
- Ride Cymbal T9
- Ride Cymbal 3
- RideCymbal Cup 2
- Hi-Hat Open T9
- Hi-Hat Closed T9
- Hi-Hat Pedal T9

SNARE DRUM 1

- Snare T9 1
- Snare T9 2
- Snare T9 3
- Snare T9 4
- Snare T9 5
- Snare T9 6
- Snare T8 7
- Snare T9 Gate 1
- Snare T9 Gate 2
- Snare T9 Rim

SNARE DRUM 2

- Snare Drum&Bass1
- Snare Jungle 1
- Snare Distortion
- Snare Analog CR
- Snare Brush Mute
- SnareRckRollDist
- Snare Piccolo
- Snare Rock Roll

TOM

- Tom T9 1
- Tom T9 2
- Tom T9 3
- Tom T9 4
- Tom T9 5

- Tom T9 6

BASS DRUM

- Kick T9 1
- Kick T9 2
- Kick T9 3
- Kick T9 4
- Kick Tek Power
- Kick Sustain
- Kick Blip Hard
- KickDistortionRM
- Kick Break 2

PERCUSSION 1

- Conga T8 1
- Conga T8 4
- Conga T8 5
- Conga Open
- Conga Open Slap
- Conga Tip
- Timbale H
- Timbale L
- Cowbell 1
- Cowbell T8
- Maracas Slur 2

PERCUSSION 2

- Surdo Mute
- Surdo Open
- Cabasa
- Analog Shaker

PERCUSSION 3

- Tambourine RX5
- Sleigh Bells
- Wind Chime
- Triangle Open
- Triangle Mute
- Clap T9
- Clap Analog Sm
- Analog Click
- Whip Slap

PERCUSSION 4

- Hi Q
- Hi Q 1
- Hi Q 2
- Hi Q 3
- Scratch H
- Scratch H 2
- Scratch H 3
- Scratch L
- Scratch L 2
- Scratch Down
- Fx Gun 1
- Fx Gun 2

House Kit

CYMBAL

- Crash Cymbal T9
- Crash Cymbal 1
- Crash Cymbal 4
- Splash Cymbal 2
- Ride Cymbal T9
- Ride Cymbal 3
- RideCymbal Cup 2
- Hi-Hat Open T9
- Hi-Hat Closed T8
- Hi-Hat Pedal T9

SNARE DRUM

- Snare T9 1
- Snare T9 2
- Snare T9 3
- Snare T9 5
- Snare T9 Gate

- Snare T9 Rim
- Snare T8 1
- Snare T8 5
- Snare T8 Rim
- Snare Garg L
- Snare R&B 1
- Snare Roll
- Snare Break Roll

TOM

- Tom T9 1
- Tom T9 2
- Tom T9 3
- Tom T9 4
- Tom T9 5
- Tom T9 6

BASS DRUM

- Kick T9 1
- Kick T9 2
- Kick T9 4
- Kick T9 5
- W Kick
- Filter Kick

NOISE

- PinkNoise Down 1
- PinkNoise Down 2
- Pink Noise Up
- PinkNoise Up Rel
- WhiteNoiseDown 1
- WhiteNoiseDown 2
- White Noise Up 1
- White Noise Up 2
- WhiteNoiseUp Rel
- Noise Burst
- Disco Fx

PERCUSSION 1

- Conga H Open 2
- Conga H SlapOpen
- Conga H Tip
- Bongo H Open 1 F
- Bongo L Open 3 F
- Timbale H
- Timbale L
- Cowbell 1
- Cowbell T8
- Claves
- Guiro Long
- Guiro Short
- Maracas Slur 2

PERCUSSION 2

- Cuica H
- Cuica L
- Cabasa
- Agogo H
- Agogo L
- Analog Shaker
- Udu High

PERCUSSION 3

- Tambourine Hit
- Sleigh Bells
- Wind Chime
- Triangle Open
- Triangle Mute
- Wood Block H
- Wood Block L
- Clap T9
- Hand Clap
- Vox Drum H
- Vox Drum L
- Vox Alk
- Vox Bell

HipHop Kit

CYMBAL

- Crash T8
- Crash Cymbal 3
- Ride Cymbal 3
- Hi-Hat Open Hip
- Hi-Hat Open T8 2
- Hi-HatOpen Lo-Fi
- Hi-HatClosed Hip
- Hi-HatClosedT8 2
- Hi-HatClosed Tek
- Hi-Hat Pedal Hip
- Hi-HatReverseD&B

SNARE DRUM

- Snare HipHop 1
- Snare HipHop 2
- Snare HipHop 3
- Snare HipHop 5
- Snare HipHop 6
- Snare HipHop 7
- Snare HipHop 11
- Snare T8 1
- Snare T8 1 H
- Snare Clappy
- SnareAnalogSmRim
- SnareHipHopRim 2
- SnareHipHopRim 3
- SnareHipHopRim 4
- SnareHipHopRim 5

TOM

- Floor Tom L
- Low Tom
- Mid Tom L
- High Tom
- Tom T8 1
- Tom T8 2
- Tom T8 3
- Tom T8 6

BASS DRUM

- Kick HipHop 1
- Kick HipHop 2
- Kick HipHop 3
- Kick HipHop 4
- Kick HipHop 5
- Kick HipHop 8
- Kick HipHop 9
- Kick HipHop 10
- Kick Hip Deep
- Kick Analog CR
- Kick Gate
- KickGranCasaOpen

PERCUSSION 1

- Conga H Open
- Conga H Heel
- Conga H Tip
- Conga L Open 1
- Conga L Open 2

PERCUSSION 2

- Surdo Mute
- Surdo Open
- Shaker 2
- HipHop flex 1
- HipHop flex 2
- HipHop Snap 1
- HipHop Snap 2

PERCUSSION 3

- TambourineLight1
- TambourineLight2
- Handbell H
- Wind Chime

Keyboard Percussion

- Triangle Open
- Triangle Mute
- Whip Slap
- HipHop Clap 2
- HipHop Clap 3
- HipHop Clap 5
- HipHop Clap 6
- HipHop Clap 7
- Electric Clap 1
- Electric Clap 2

PERCUSSION 4

- Hi Q
- Scratch H
- Scratch L
- ScratchBDForward
- ScratchBDRReverse

Drum Machine

CYMBAL

- Crash Cymbal T9
- Ride Cymbal T9
- Hi-Hat Open T8 1
- Hi-Hat Open T8 2
- Hi-Hat Open T9
- Hi-Hat Open Aco
- Hi-HatOpen Lo-Fi
- Hi-Hat Open Syn
- Hi-HatClosedT8 1
- Hi-HatClosedT8 2
- Hi-Hat Closed T9
- Hi-HatClosedAco
- Hi-HatClosedLoFi
- Hi-HatClosed Syn
- Hi-Hat Pedal T9
- Hi-Hat Pedal Aco

SNARE DRUM

- Snare T8 1
- Snare T8 2
- Snare T8 3
- Snare T9 1
- Snare T9 4
- Snare T9 Rim
- Snare R&B 1
- Snare R&B 2
- Snare Hip 1
- Snare Timbre
- Snare Wood
- Snare Drum&Bass1
- Snare Drum&Bass2
- Snare Jungle 1
- Snare Analog CR
- Snare Distortion

TOM

- Tom T9 1
- Tom T9 2
- Tom T9 3
- Tom T9 4
- Tom T9 5

BASS DRUM

- Kick T8 2
- Kick T8 3
- Kick T9 2
- Kick T9 4
- Kick T9 HD 3
- Kick Tek Power
- Kick Break 2
- KickDistortionRM
- BD Drum & Bass 1
- Bass Drum Dist 1
- Bass Drum Dist 3
- Bass Drum Dist 5

- BassDrumTekPower
- BassDrumHardLong
- Bass Drum Blip
- BassDrumAnalogSm

PERCUSSION 1

- Conga T8 1
- Conga T8 2
- Conga T8 3
- Cowbell T8
- CowbellAnalog CR
- Claves T8 1
- Claves T8 2
- Maracas T8

PERCUSSION 2

- Surdo Mute
- Surdo Open
- Analog Shaker
- Analog Shaker 1
- Analog Shaker 2

PERCUSSION 3

- Tambourine RX5 2
- Tambourine 1 Hit
- TambourineAna CR
- ElectricTriangle
- Electric Cowbell
- Clap T9
- Whip Slap
- Electric Clap 1

PERCUSSION 4

- Hi Q
- Scratch H
- Scratch L
- Analog Click

Break Kit

CYMBAL

- Crash Cymbal 1
- Crash Cymbal 2
- Splash Cymbal 2
- China Cymbal 2
- Ride Cymbal 2
- Ride Cymbal 3
- RideCymbal Cup 2
- Hi-HatClosedBrk1
- Hi-HatClosedBrk2
- Hi-HatClosedBrk3
- HH HalfOpen Rock
- HHClosedRockSoft
- Hi-Hat PedalRock

SNARE DRUM 1

- Snare Break 1
- Snare Break 2
- Snare Break 3
- Snare Break 4
- Snare Break 5
- Snare Break 6
- Snare Break 7
- Snare Break 8
- Snare Break 9
- Snare Break Rim

SNARE DRUM 2

- Snare Gate 1
- Snare Clappy
- Snare Hip
- Snare Hip Rim 1
- Snare Hip Rim 4
- Snare LdwH Mono
- Snare Lo-Fi
- Snare Mid
- Snare Rock Roll

TOM

- Tom Break 1
- Tom Break 2
- Tom Break 3
- Tom Break 4
- Tom Break 5
- Tom Break 6

BASS DRUM

- Kick Break 1
- Kick Break 2
- Kick Break 3
- Kick Break 4
- Kick Break 5
- Kick Break 6
- Kick Break 7
- Kick Break Deep
- Kick Break Heavy

PERCUSSION 1

- Conga H Open
- Conga H OpenSlap
- Conga H Tip
- Conga Open
- Bongo H
- Bongo L
- Bongo 2 H
- Bongo 2 L
- Timbale H
- Timbale L
- Cowbell 1
- Cowbell RX11
- Claves
- Maracas Slur

PERCUSSION 2

- Surdo Mute
- Surdo Open
- Cabasa
- Agogo L
- Scratch H
- Scratch L
- Scratch H 2
- Scratch L 2
- Scratch H 3
- Scratch Down

PERCUSSION 3

- Tambourine 1 Hit
- Hi Q
- Triangle Open
- Triangle Mute
- Wood Block H
- Wood Block L
- Whip Slap
- Finger Snap

SFX Kit 1

SFX

- Cutting Noise 1
- Cutting Noise 2
- String Slap
- Flute Key Click
- Shower
- Thunder
- Wind
- Stream
- Bubble
- Feed
- Ghost
- Maou
- Dog
- Horse
- Bird Tweet

SFX Kit 2

SFX 1

- Phone Call
- Telephone Ring
- Wind Chime
- Door Squeak
- Door Slam
- Scratch Cut
- Scratch Split
- Laugh
- Scream
- Punch
- Heart Beat
- Foot Steps

SFX 2

- CarEngn Ignition
- Car Tires Squeal
- Car Passing
- Car Crash
- Siren
- Train
- Jet Plane
- Starship
- Burst
- Roller Coaster
- Submarine
- Machine Gun
- Laser Gun
- Explosion
- Firework

Live! SFX Kit 1

SFX

- Cutting Noise 1
- Cutting Noise 2
- String Slap
- Flute Key Click
- Shower 2
- Thunder 2
- Wind 2
- Stream 2
- Bubble 2
- Feed
- Ghost
- Maou
- Dog
- Horse
- Bird Tweet

Live! SFX Kit 2

SFX 1

- Phone Call
- Telephone Ring 2
- Wind Chime
- Door Squeak 2
- Door Slam 2
- Scratch Cut
- Scratch Split
- Laugh
- Scream 2
- Punch 2
- Heart Beat
- Foot Steps 2

SFX 2

- CarEngn Ignition
- Car Tires Squeal
- Car Passing
- Car Crash
- Siren 2

- Train 2
- Jet Plane 2
- Starship
- Burst
- Roller Coaster
- Submarine
- Machine Gun 2
- Laser Gun
- Explosion 2
- Firework

Noise Kit

NOISE

- White Noise
- WhiteNoiseDown 1
- WhiteNoiseDown 2
- White Noise Up 1
- White Noise Up 2
- WhiteNoiseUp Rel
- WhiteNoiseUp LFO
- Pink Noise
- PinkNoise Down 1
- PinkNoise Down 2
- Pink Noise Up
- PinkNoise Up Rel
- PinkNoise Up LFO

VocalEffectsKit

FEMALE 1

- Female Bh 1
- Female Bh 2
- Female Bh 3
- Female Bh 4
- Female Ha 1
- Female Ha 2
- Female Kh 1
- Female Kh 2
- Female Kh 3
- Female Kh 4
- Female Ph 1
- Female Ph 2
- Female Ph 3
- Female Ph 4

FEMALE 2

- Female Th 1
- Female Th 2
- Female Th 3
- Female Th 4

MALE 1

- Male Bh 1
- Male Bh 2
- Male Bh 3
- Male Bh 4
- Male Ha 1
- Male Ha 2
- Male Ha 3
- Male Ha 4
- Male Ha 5
- Male Ha 6
- Male Kh 1
- Male Kh 2
- Male Kh 3
- Male Kh 4

MALE 2

- Male Ph 1
- Male Ph 2
- Male Ph 3
- Male Ph 4
- Male Th 1
- Male Th 2

- Male Th 3
- Male Th 4

GospelAdLibs

GOSPELADLIBS 1

- Aaoh
- Aha!
- Heeey
- Hoo!
- Oh Yeah
- Uhh Yeah
- Yayayayah
- Yeah!
- C'mon
- C'mon Now
- Come On!
- Alright Now!
- Everybody Now
- Put Your Hands...
- Stand Up On...
- WithAllYourSoul

GOSPELADLIBS 2

- One
- Two
- Three
- Four
- One!
- Two!
- Three!
- Four!
- Five!
- Six!
- Seven!
- Eight!
- Clap!
- ClapYourHands...
- Gospel Clap 1
- Gospel Clap 2

Wonderland Kit

SE

- Laser Beam
- Laser Shot
- Water Phone
- Bubble
- Puddle

NATURE

- Thunder
- Shower
- Beach
- Stream

DAILY

- Footstep
- Door Squeak
- Door Slam
- Alarm Bell
- Cuckoo Clock
- Big Clock
- Bell
- Telephone
- Camera
- Gnaw
- Applause

VEHICLE

- Train
- Horn 1
- Horn 2
- Siren
- CarEngn Ignition

- Car Crash
- Helicopter
- Starship

ANIMAL

- Sheep
- Goat
- Oxen
- Whinny
- Horse
- Lion
- Dog
- Cat
- Hen
- Owl
- Insects
- Frog
- Tweet 1
- Tweet 2

PERCUSSION 1

- Cymbal
- Snare
- Snare Roll
- Hi-Hat Open
- Hi-Hat Closed
- Tom 1
- Tom 2
- Bass Drum
- Gran Cassa

PERCUSSION 2

- Tambourine
- Castanet
- Jingle Bells
- Bell Tree
- Triangle Open
- Triangle Mute
- Wood Block H
- Wood Block L
- Finger Snap
- Hand Clap

Pop Latin Kit

CONGA

- Conga H Tip
- Conga H Heel
- Conga H Open
- Conga H Mute
- Conga H SlapOpen
- Conga H Slap
- Conga H SlapMute
- Conga L Tip
- Conga L Heel
- Conga L Open
- Conga L Mute
- Conga L SlapOpen
- Conga L Slap
- Conga L Slide

BONGO

- Bongo H Open 1 f
- Bongo H Open 3 f
- Bongo H Rim
- Bongo H Tip
- Bongo H Heel
- Bongo H Slap
- Bongo L Open 1 f
- Bongo L Open 3 f
- Bongo L Rim
- Bongo L Tip
- Bongo L Heel
- Bongo L Slap

PERCUSSION 1

- Timbale H
- Timbale L
- Paila H
- Paila L
- Cowbell Top
- Cowbell 1
- Cowbell 2
- Cowbell 3
- Cowbell High 1
- Cowbell High 2
- Claves High
- Claves Low
- Guiro Long
- Guiro Short
- Metal Guiro Long
- Metal Guiro Short

PERCUSSION 2

- Maracas
- Cuica Open
- Cuica Mute
- Cabasa
- Shaker
- Tambourine
- Tambourim Tip
- Tambourim Open
- Tambourim Mute
- Castanet
- Triangle Open
- Triangle Mute
- Wind Chime

PERCUSSION 3

- Hand Clap
- Finger Snap
- Shekere
- Shekere Tone
- Cajon Low
- Cajon Slap
- Cajon Tip

Arabic Kit

ARABIC 1

- Nakarazan Dom
- Nakarazan Edge
- Hager Dom
- Hager Edge
- Zagrouda H
- Zagrouda L
- Arabic Hand Clap
- Duhulla Dom
- Duhulla Tak
- Duhulla Sak
- Doff Dom
- Doff Tak

ARABIC 2

- Katem Dom
- Katem Tak
- Katem Sak
- Tabla Dom
- Tabla Tak 1
- Tabla Tak 2
- Tabla Sak
- Tabla Tik
- Tabla Roll Edge
- Tabla Flam
- Tabel Dom
- Tabel Tak

ARABIC 3

- Sagat 1
- Sagat 2
- Sagat 3

Keyboard Percussion

- Rik Dom
- Rik Tak 1
- Rik Tak 2
- Rik Sak
- Rik Tik
- Rik Finger 1
- Rik Finger 2
- Rik BrassTremolo

CYMBAL/SNARE DRUM

- Crash Cymbal 1
- Crash Cymbal 2
- Ride Cymbal 1
- Hi-Hat Open
- Hi-Hat Closed
- Hi-Hat Pedal
- Snare Drum
- Snare Soft
- Side Stick

TOM/BASS DRUM

- Floor Tom L
- Floor Tom H
- Low Tom
- Mid Tom L
- Mid Tom H
- High Tom
- Kick Soft

PERCUSSION

- Conga H Open
- Conga L
- Conga H Mute
- Bongo H
- Bongo L
- Cowbell
- Claves
- Cabasa
- Tambourine

Turkish Kit

CYMBAL

- Zil Right Open
- Zil Right Close
- Zil Left Open
- Zil Left Close

BONGO

- Bongo Tek
- Bongo Tek Roll
- Bongo Tek Flam
- Bongo Dum
- Bongo Slap
- Bongo Flam
- Bongo Flam Hi

DAVUL

- Asma Davul L
- Asma Davul R
- Asma Davul Side
- Asma Davul Both
- KoltukDavul Teke
- Koltuk Davul Tek
- Koltuk Davul Dum
- KoltukDavul Flam

DARABUKA 1

- Darbuka Tek 1
- Darbuka Tek 2
- Darbuka Tek Dead
- DarbukaTekDamped
- DarbukaTekeFin 1
- DarbukaTekeFin 2
- DarbukaTekeFin 3
- DarbukaTekeFin 4
- Darbuka Teke

- DarbukaTekeFlamD
- Darbuka TekeFlam
- Darbuka Slap
- Darbuka Slap Med
- Darbuka RollOpen
- DarbukaRollClose
- Darbuka Dum

DARABUKA 2

- Bass Darbuka Tek
- BDarbuka TekDead
- BDarbuka TekFlam
- BassDarbuka Teke
- BDarbukaTekeFin1
- BDarbukaTekeFin2
- BassDarbukaSlap1
- BassDarbukaSlap2
- Bass Darbuka Dum

BENDIR

- Bendir Tek
- Bendir Tek Dead
- Bendir Teke
- Bendir Teke Flam
- Bendir Teke Dead
- Bendir Slap
- Bendir Dum

TEF

- Tef Tek Flam
- Tef Tek Open
- Tef Tek Mute
- TefTekMuteMedium
- Tef Tek Op Short
- Tef Teke Flam
- Tef Teke Damped
- Tef Teke OpShort
- Tef Dum Open
- Tef Dum Mute
- Tef Cymbal
- Tef Cymbal Mute
- Tef Shake 1
- Tef Shake 2
- Tef Full Open
- Tef Tremolo

PERCUSSION

- Hollo FingerDead
- Hollo Slap
- Hollo Dum
- Kasik
- Kasik Flam

China Kit

CYMBAL

- Da Cha 1
- Da Cha 2
- Da Cha Effect
- Zhongcha
- Xiaocha
- Xiaocha Effect
- Gong Batter
- Luo Big
- Luo
- Luo Mid-Low
- Luo High 1
- Luo High 2
- Jin Luo
- Jin Luo Low
- Mang Luo Low
- Mang Luo Mid

DRUM

- Da Gu f
- Da Gu mp
- Da Gu Rim

- Da Gu Roll
- Da Gu Hand
- Pai Gu 1
- Pai Gu 2 High
- Pai Gu 2
- Pai Gu 3 High
- Pai Gu 3
- Pai Gu 4 High
- Pai Gu 4

GONG 1

- Yunluo F
- Yunluo F#
- Yunluo G
- Yunluo G#
- Yunluo A
- Yunluo A#
- Yunluo B
- Yunluo C
- Yunluo C#
- Yunluo D
- Yunluo D#
- Yunluo E
- Yunluo High F
- Yunluo High F#
- Yunluo High G
- Yunluo High G#

GONG 2

- Yunluo High A
- Yunluo High A#
- Yunluo High B
- Yunluo High C

PERCUSSION

- Muyu Low
- Muyu Mid-Low
- Muyu Mid
- Muyu High
- Ban
- Bangu
- Bangu Roll
- Nanbangzi
- Nanbangzi Roll
- Qing
- Finger Bell
- ChineseOperaVo 1
- ChineseOperaVo 2
- ChineseOperaVo 3

OrchestraPerc

CYMBAL

- China Cymbal
- Finger Cymbal
- Orch Cymbal 1
- OrchCymbal 1 ckd
- Orch Cymbal 2
- Ride Cymbal Tip
- Ride Cymbal Cup
- Splash Cymbal
- Sus Cymbal 1
- Sus Cym 1 Roll S
- Sus Cymbal 2
- Sus Cym 2 Roll L

SNARE DRUM

- ConcertSnareDrum
- Snare Drum Light
- Snare Ensemble
- Snare Roll

TOM

- Concert Tom 1
- Concert Tom 2
- Concert Tom 3
- Concert Tom 4

- Concert Tom 5
- Rotating Tom 1
- Rotating Tom 2
- Rotating Tom 3
- Rotating Tom 4
- Rotating Tom 5

BASS DRUM

- Gran Cassa Hard
- Gran Cassa Soft
- Gran Cassa Hit
- Gran Cassa Cresc

GONG

- Gong
- Symphonic Gong 1
- Symphonic Gong 2
- Symphonic Gong L

TIMPANI

- Timpani E
- Timpani F
- Timpani F#
- Timpani G
- Timpani G#
- Timpani A
- Timpani A#
- Timpani B
- Timpani C
- Timpani C#
- Timpani D
- Timpani D#
- Timpani High E

PERCUSSION 1

- Conga H Stick
- Conga L Stick
- Bongo H Stick
- Bongo L Stick
- Cowbell
- Claves
- Bell Tree
- Sleigh Bells
- Tubular Bell H
- Tubular Bell M
- Tubular Bell L
- Wind Chime
- Jingle Ring
- Tambourine
- Castanet Roll
- Table Castanet

PERCUSSION 2

- Triangle Open
- Triangle Mute
- Triangle Roll
- Wood Block H
- Wood Block L
- Temple Block H
- Temple Block L
- Anveil
- Whip

6 Registration Memory

Registration Memory allows you to store virtually all the settings you make on the panel and LCD, providing a convenient way to instantly change all Voice settings and rhythms while you're playing, with the simple touch of a single button on the Registration Memory panel. The buttons are conveniently located between the Upper and Lower keyboards for easy access while playing. Moreover, you can also recall the settings using the right footswitch. All Registrations in Registration Memory can also be saved to a USB flash drive.

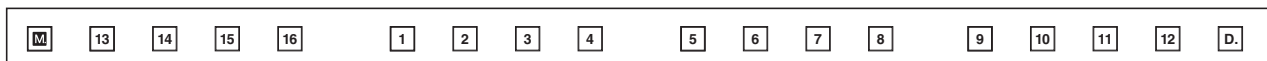

Registration Memory and Bank

The ELS-02 series lets you create up to five Registration Banks A – E, each of which consists of 1 – 16 Registration Memories. Although preset various Registrations are stored to the Number buttons 1 – 16 of only Bank A by default, you can replace them with your original Registrations. Your original Registrations can be stored also to Banks B – E, up to a maximum of 80 Registrations. Executing the Initialize function (page 98) recalls the preset Registrations of Bank A, and then resets the created Registrations of Banks B – E to their original empty status.

Storing Registrations

Newly created Registrations you make can be stored to the Registration Memory panel buttons. All Registrations in Registration Memory can also be saved to a USB flash drive for future recall.

Reference pages

- Selecting a Voice (page 25)
- Selecting a Rhythm (page 56)
- Voice Controls and Effects (page 42)

- 1 **Create your original Registration.**
- 2 **While holding down the [M.] (Memory) button in the Registration Memory section, press the numbered button to which you wish to save your Registration.**

1. While holding down the [M.] button...

2. Press desired numbered button.

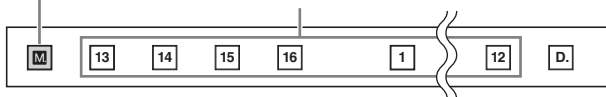

When saving of the Registration is started, the numbered button flashes momentarily, until the operation is completed.

NOTICE

When recording Registration settings, the square at the top left of the display turns light blue for a few seconds, indicating that the Registration is currently being saved. Do not turn the power off while the Registration is being saved, otherwise the data will be lost.

Functions and settings that cannot be memorized:

The following settings cannot be stored to a Registration Memory number.

- Pitch (page 184)
- MIDI Control settings (page 192)
- Mic. Volume (page 189)
- Mic. Reverb (page 189)
- LCD related settings (page 16)
- Wireless LAN settings (page 193)
- Score related settings except Next Page (page 125)

The following settings common to all Registration Memory numbers 1 – 16 and cannot be stored individually for each number.

Reference page

- Saving Registrations and Other Data to a USB Flash Drive (page 118)
- Transpose (page 184)
- Attack mode in Organ Flute Voices (page 40)
- Registration Shift (page 99)
- Auto Fill setting (page 58)
- Reverb type (page 47)
- User Voices (page 144)
- User rhythms (page 161)
- User Keyboard Percussion (page 81)
- Rhythm Sequences (page 172)
- Disable setting (page 96)
- Disable mode (page 97)
- Next Page setting of score setting (page 125)

Storing Registrations to Another Bank

With the default initial settings and Bank A selected, you can store your original Registrations to Banks A and B. Storing the Registrations to Bank B enables selection of Bank C. Similarly, storing Registrations to Bank C enables selection of Bank D, and so on, up to a maximum of Bank E.

1 At the lower right section of the Voice Display, select the Registration Bank.



You can select the Banks from A (at top) to an empty Bank next to the last Bank containing data. When Banks A and B contain Registration data, for example, you can select Banks A, B, and C (which is empty). The on/off indication of Bank (A – E) shows whether the selected Bank contains data or not.



2 Create your original Registration, then store it to any of the Number buttons 1 – 16. (This corresponds to steps 1 – 2 on page 95.)

Here, the Registration will be stored to Number button [1] of Bank B.



NOTE

When you try to store Registrations after changing the Bank, a confirmation dialog appears. Confirm whether or not you want to set the current Bank as the destination.

Selecting Registrations

Select a Bank, then press the numbered button that corresponds to the Registration you wish to select.

- You can also recall Registrations by using the right footswitch. This function is called “Registration Shift” (page 99).
- You can also program the Registrations to change automatically at specific points within the Rhythm Sequence. This function is called “Registration Sequence” (page 174).

Using the [D.] (Disable) button:

Rhythm and automatic accompaniment patterns also change when you select different Registration Memory buttons. Pressing the [D.] (Disable) button allows you to keep the same rhythm, accompaniment patterns, tempo, and so on throughout all your Registration changes, or make your own rhythm selections if you want to (while the [D.] button is lit).

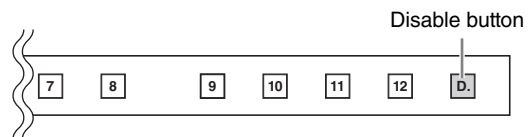

The particular settings that do not change when the [D.] (Disable) button is on depend on the Disable mode setting. For details on the Disable mode, see “Selecting Disable Mode” below.

NOTE

The Disable function is available even after changing the Bank.

Selecting Disable mode:

The Disable mode enables you to select what is to be disabled when the [D.] (Disable) button is on. There are two Disable modes: Normal (rhythm menu, tempo, etc. are disabled) and Tempo (only tempo is disabled).

- 1 Press the [UTILITY] button to call up the GLOBAL Page of the Utility display.
- 2 Press the DISABLE MODE [NORMAL] or [TEMPO] button.

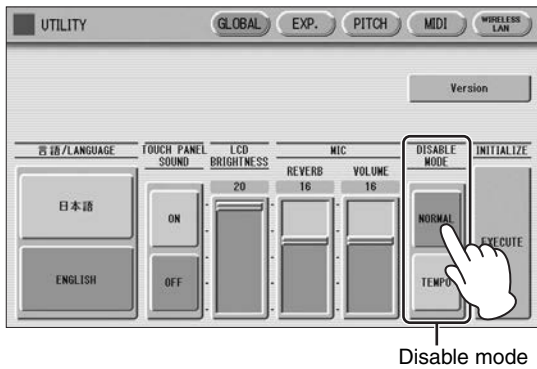

NORMAL

When the Electone is set to the Normal mode and the [D.] (Disable) button is on, the following functions will not change, even when you change the Registration Memory number.

- Rhythm menu, Rhythm section, Rhythm tempo, Rhythm volume, Rhythm reverb
- Rhythm reverb time
- Accompaniment volume, Accompaniment reverb, On/Off status of Accompaniment parts
- A.B.C. mode, A.B.C. memory
- M.O.C. mode, Knee lever control for M.O.C.
- Second expression pedal control for rhythm tempo

TEMPO

When the Electone is set to the Tempo mode and the [D.] (Disable) button is on, the rhythm tempo will not change, even when you change the Registration Memory number.

Saving the Registration Data to USB Flash Drive

The Registration data stored to the Number buttons can be saved to a USB flash drive connected to the [USB TO DEVICE] terminal.

Reference page

- Saving Registrations and Other Data to a Unit (page 118)

With the MDR function, up to five Banks of the Registration Memory stored to internal memory of the instrument can be saved to a USB flash drive as a single Song file. Although detailed information about the MDR is described on chapter 7, these instructions show how to save the Registration data to a USB flash drive.

- 1 Insert a USB flash drive into the [USB TO DEVICE] terminal.
- 2 Press the [MDR] button on the panel to call up the MDR display.

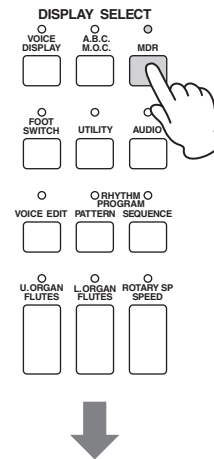

- 3 Select the Song to which you want to save the Registration data (page 112).

4 Press the [UNIT EDIT] button on the lower right side of the display to call up the Unit Edit display.

5 Press the [SAVE] button in the display.
 A message appears, indicating the Registration data is currently being saved.
 When the operation is completed, the message closes.

- Reference pages**
- Recalling Recorded Registrations (page 120)
 - Changing the Song Name (page 116)

The Registration data stored to Banks A – E is now saved as a Unit to the USB flash drive.

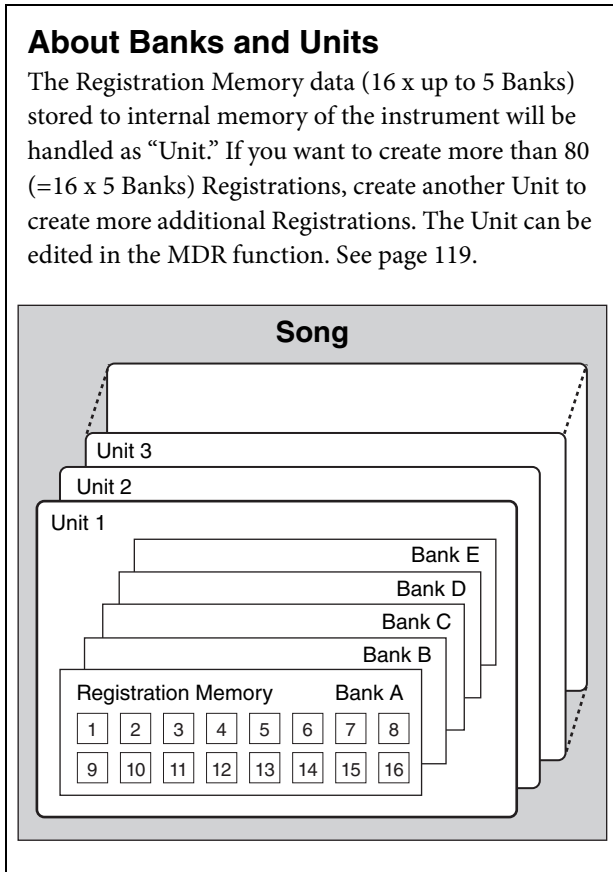

Initializing Registration Memory

Deleting all Registration data in Registration Memory initializes the Registration Memory. Be careful when using this operation, since it erases all your existing data. In order to avoid inadvertently losing your important data, save it to a USB flash drive.

- Reference page**
- Factory Set (Initializing the Electone); (page 23)

1 Press the [UTILITY] button on the panel to call up the GLOBAL Page in the Utility display.

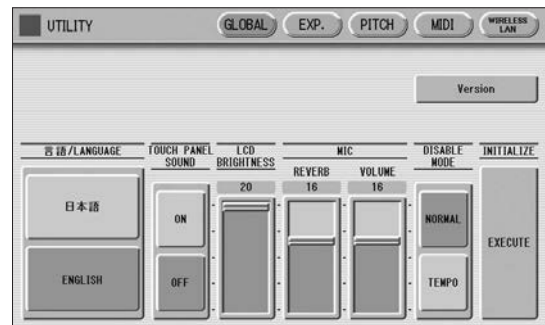
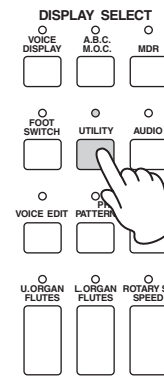

2 Press the INITIALIZE [EXECUTE] button on the right side in the display.

The message “Are you sure you want to initialize Registration data?” appears.
 Press [INITIALIZE] to actually initialize the data.
 When the operation is complete, the Electone will be restarted.
 Press [CANCEL] to cancel the operation.

Registration Shift

The Registration Shift function allows you to change Registrations without taking your hands from the keyboards. By using the Right Footswitch on the expression pedal, you can “jump” to a specified Registration or step through the panel Registrations in sequence, either in numeric order or in any order you specify.

Registration Shift has three modes: Shift, Jump and User. These are set in the Regist Shift display. You can also view and check the Registration Shift mode in the Voice Display.

Setting the Registration Shift mode in the Regist Shift display

- 1 Press the [FOOT SWITCH] button on the panel.
- 2 Press the [RIGHT] button at the top right of the display to call up the RIGHT Page (REGIST SHIFT display).

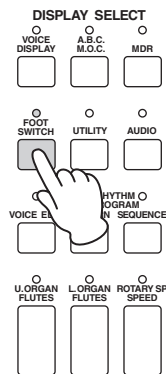

REGIST SHIFT display

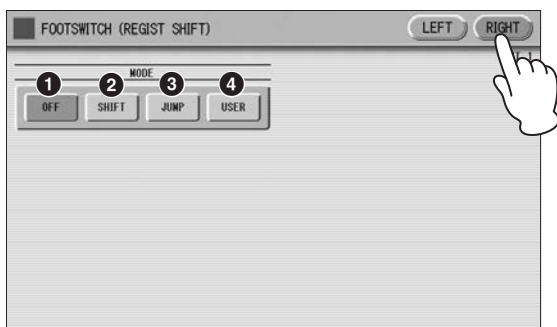

1 OFF

Turns off the Registration Shift assignment. When you select OFF, you cannot change Registrations by using the Right Footswitch.

2 SHIFT



In the Shift mode, each press of the Right Footswitch selects the Registration Memory presets in their numerical order. After the last Registration is reached, the function ‘wraps around’ to select the first preset again. The numbered buttons light up as they are selected.

NOTE

In the Shift mode, the Right Footswitch cannot call up another Registration Bank.

3 JUMP

Pressing the Right Footswitch jumps to select the designated panel Registration.

You can set the Jump “destination” with   buttons in the display or the Data Control dial.

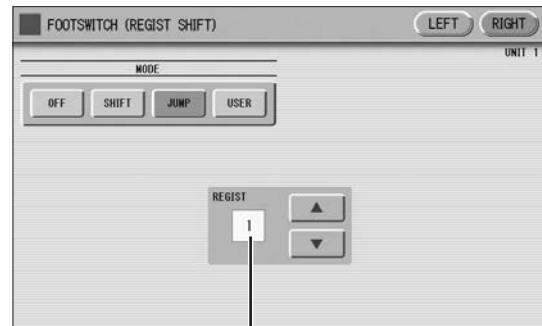

Registration number of the destination

4 USER

In the User mode, each press of the Right Footswitch selects Registrations according to the order you’ve specified.

To set the User Registration order:

- 1 **Select a Bank.**
- 2 **Press the desired numbered button in the Registration Memory section.**
- 3 **Press the DATA [SET] button in the display.**
The Bank letter and Registration number appear in the display, indicating that the Registration is entered.
- 4 **Repeat steps 2 and 3 above to set the Registration order.**

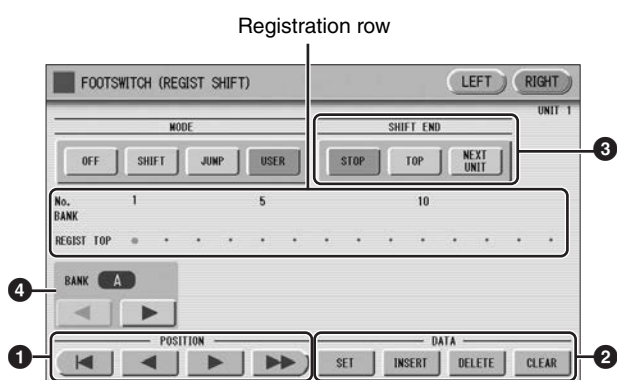

1 POSITION

These are cursor controls used to move the cursor (colored orange) along the Registration row in the display. Entered Registration numbers are shown in boxes, while the numbers in the row above indicate the position in the sequence (in other words, the number of successive presses of the Right Footswitch). Up to 400 steps (Registrations) can be memorized.

- Moves the cursor to the first position.
- Moves the cursor one step to the left.
- Moves the cursor one step to the right.
- Moves the cursor five steps to the right.

2 DATA

These are data controls used to enter and delete Registration numbers in the Registration row.

SET: For initially entering a Registration number to a blank space in the Registration row, or for replacing a number at the current cursor position.

To enter a number, press the desired Registration Memory button (the selected button will light), then press [SET] in the display. The entered Registration number will appear in the Registration row. After using SET to enter Registrations, the cursor can be moved among the numbers.

INSERT: For inserting a Registration number just before the current cursor position.

To perform the operation, first move the cursor to a numbered position. Then, press the desired Registration Memory button (the selected button will light), and press [INSERT] in the display. The new Registration number is inserted at the cursor position and all other numbers to the right of the cursor are moved to accommodate the new numbers.

Registration numbers cannot be entered beyond the Registration Shift function's capacity of 400. If the insert operation exceeds this capacity, a "Data Full" message appears and the operation cannot be executed.

DELETE: For deleting a Registration number at the current cursor position. To delete the unnecessary number, move the cursor to a numbered position and press [DELETE] in the display.

CLEAR: For erasing all current user Registration Shift settings. After selecting [CLEAR], a message appears prompting confirmation of the operation.

Select [CLEAR] to clear all data. The message "Clear all data" momentarily appears in the display and returns to the previous display.

Select [CANCEL] to abort the operation.

3 SHIFT END

Determines how to end the Registration Shift function.

STOP: Selects the last Registration and quits the operation.

TOP: After the last preset is reached, the first preset is called up again, starting the sequence over again from the beginning.

NEXT UNIT: After the last preset is reached, the next Unit in the Song is called up. This function is available only when two or more Unit sets are saved to one Song.

Reference page

- Saving Two or More Registration Units in a Song (page 118)

NOTE

- When you play the Song using Next Unit function, always press the [▶] (Play) button in the MDR display to start the Song and activate these functions. The [CUSTOM] (Custom Play) button (page 107) will not activate the Next Unit function.
- When you use the Next Unit function during Rhythm playback, Rhythm Sequence and User Rhythm cannot be loaded.

The Shift End mark (or) will automatically be put at the end of the Registrations you entered when Top or Next Unit is selected as the Shift End.

4 BANK SELECT

Selects the Bank which contains the desired Registration.

Confirming the Registration Shift setting in the Voice Display

You can confirm the Registration Shift mode in the Voice Display, Page 1.

Press the [VOICE DISPLAY] button on the panel to call up the Voice Display.

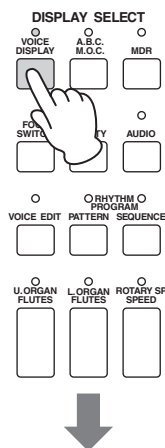

The Registration Shift mode is shown at the bottom right of the display.

Registration Shift, OFF:

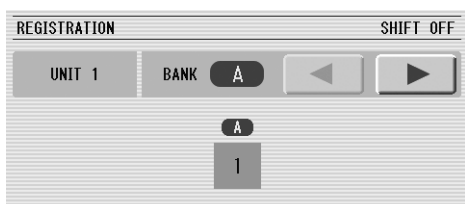

The current Registration number is displayed.

Registration Shift, in "SHIFT" mode:

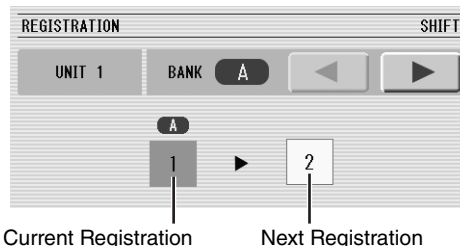

The current Registration number (left) and the next number (right) are displayed.

Registration Shift, in "JUMP" mode:

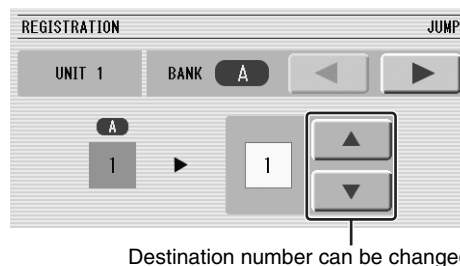

The current Registration number (left) and the destination number (right) will be displayed. You can change the destination number even in the middle of the performance by using the buttons in the display or the Data Control dial.

Registration Shift, in "USER" mode:

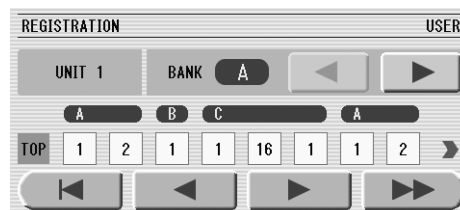

Indicates the current position of the Registration Shift. You can change the Registration by moving the cursor (in orange) right/left, using the displayed buttons or the Data Control dial. This is handy if you've inadvertently advanced the shift setting in the middle of your performance. The user Registration settings cannot be edited here.

- Moves the cursor to the first position.
- Moves the cursor one step to the left and selects the next Registration.
- Moves the cursor one step to the right and selects the previous Registration.
- Moves the cursor five steps to the right and selects the Registration.

6
Registration Memory

Unifying Values/Settings of a Specific Parameter

In the Voice Display, Page 2, you can conveniently unify the values or settings of a specific parameter used in the current Registration Bank at one time. This is useful when you are changing, for example, the Voice Brilliance setting for the Upper Keyboard and want the same setting to be applied to all Registrations in the Bank.

Available parameters

- Reverb
- Rhythm Reverb
- Volume
- Panning
- Brilliance
- Sustain

- 1 Press the [VOICE DISPLAY] button on the panel.
- 2 Press the [2] button at the top right of the display to select Page 2.

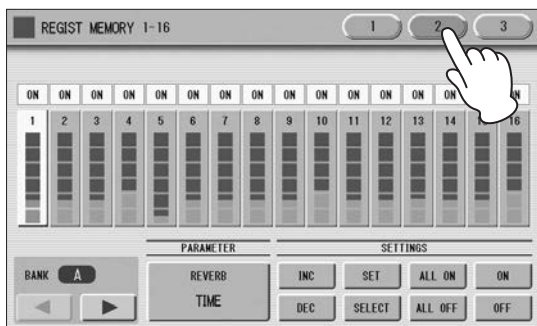
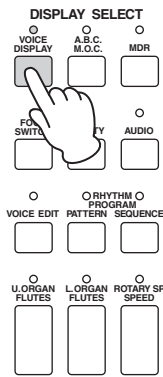

- 3 Select the Bank, then press the **PARAMETER** button (indicates the currently selected parameter) in the display to select the desired parameter for changing.

The Parameter Select pop-up menu appears, letting you select the desired parameter.

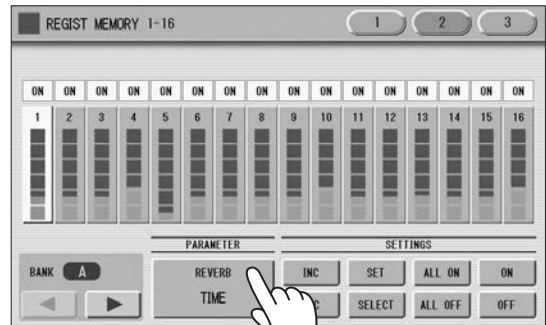

Parameter

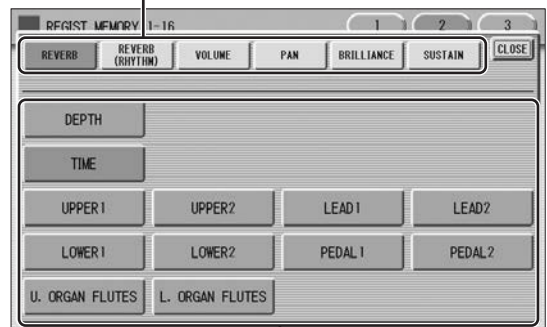

Part

Select the parameter and part in the Parameter Select pop-up menu.

After selecting the desired parameter, the pop-up menu automatically closes.

The amount of the selected parameter for each Registration is shown in the display.

Parameter value for each Registration

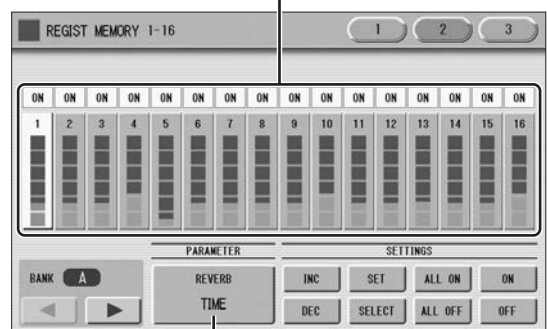

Selected parameter

NOTE

A parameter can be unified only within the current Bank.

4 Select the targeted Registration numbers and turn them on.

Parameters in Registrations set to ON will be changed.

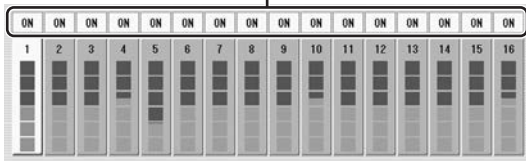

Press the targeted Registration in the display and turn it on with the SETTINGS buttons: ALL ON, ALL OFF, ON, OFF, and SELECT.

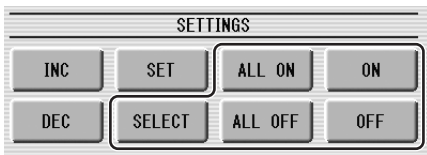

ALL ON: Selects all Registration memory numbers.

ALL OFF: Cancels all Registration memory numbers.

ON: Sets the currently selected Registration memory number to "ON."

OFF: Sets the currently selected Registration memory number to "OFF."

SELECT: Turns on the Registration memory numbers that contain the same Voice as the one which is currently set in the Registration at the cursor position.

The targeted Registration numbers are underlined.

5 Unifies the currently turned-on parameter's values.

You unify the relevant parameter values in each Registration memory number or offset them. Keep in mind that you cannot restore the original data once you change the parameter's value.

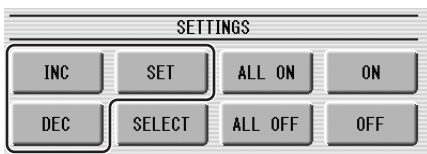

Unifying the currently highlighted parameter's value:

Pressing [SET] unifies the currently highlighted parameter's values to the one in the currently selected Registration (at the cursor position). A message appears prompting you to confirm the operation.



To continue the operation, select [UNIFY]. Select [CANCEL] to abort the operation.

Offsetting the currently highlighted parameter's value:

Pressing the [+]/[-] buttons in the display or using the Data Control dial offsets the currently highlighted parameter's value. If you select Pan as the parameter, the [◀][▶] buttons are shown instead of [+]/[-].

If you change the value, and if parameter values for some Registration memory number reach the maximum or minimum, the following message appears.

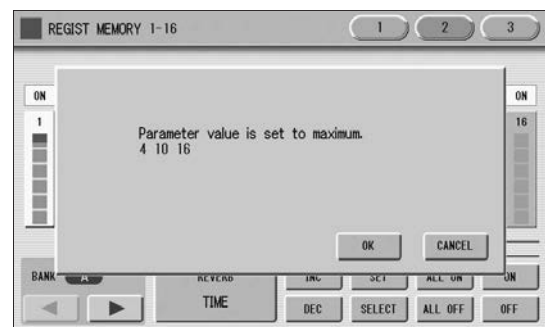

In this case, pressing [OK] continues the operation, ignoring those parameters at maximum or minimum value. Pressing [CANCEL] aborts the operation.

Copying Registrations

In the Voice Display, Page 3, you can copy a Registration stored to a specific Registration Memory number to another number on a specific section basis (Voices, rhythm, keyboard percussion). (The function is called Regist Section Copy.) This is useful, for example, when you want the upper keyboard Voice in Registration number 4 to be the same as in Registration number 1.

- 1 Press the [VOICE DISPLAY] button on the panel to call up the Voice Display.
- 2 Press the [3] button at the top right of the display to call up Page 3.

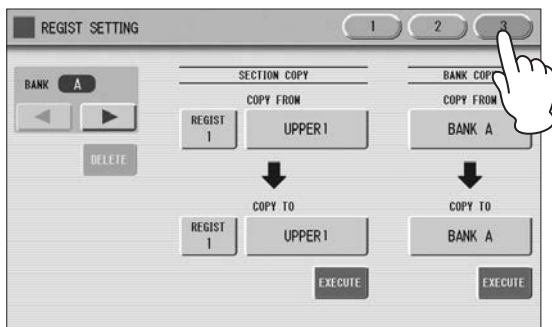
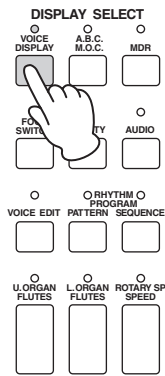

- 3 Press the Registration number button at the lower left of "COPY FROM."
- To abort the operation press the [CLOSE] button.

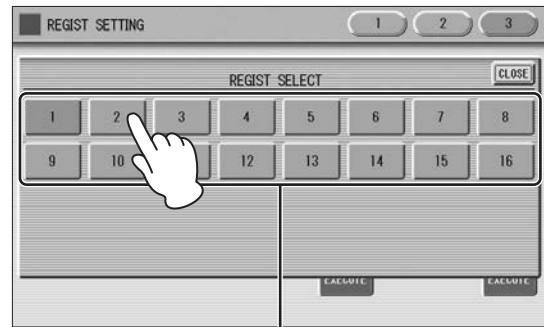
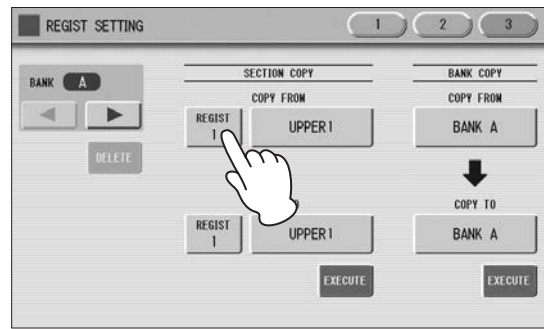

Registration number

- 4 Press the Voice Section button at the lower right of "COPY FROM" to select the Voice Section as source.

To abort the operation press the [CLOSE] button.

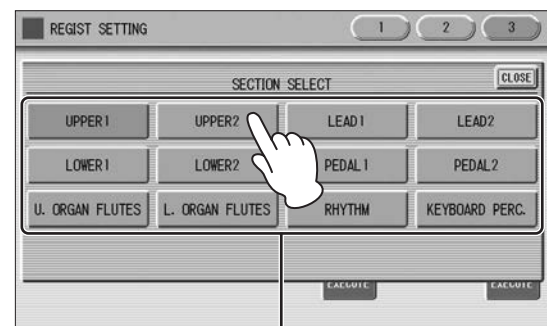
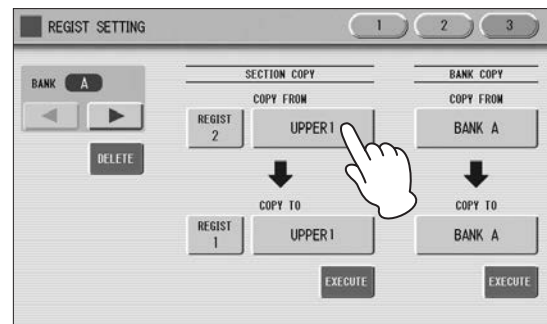

Section

5 In the same way, select the COPY TO Registration number and Regist Section.

The COPY TO Regist Section depends on the Regist Section selected for COPY FROM.

NOTE

If you change the source Regist Section after changing the destination Regist Section the destination may automatically change to the section selected as the source Regist Section.

6 Press the [EXECUTE] button in the SECTION COPY area in the display.

The following display appears, prompting confirmation of the operation.

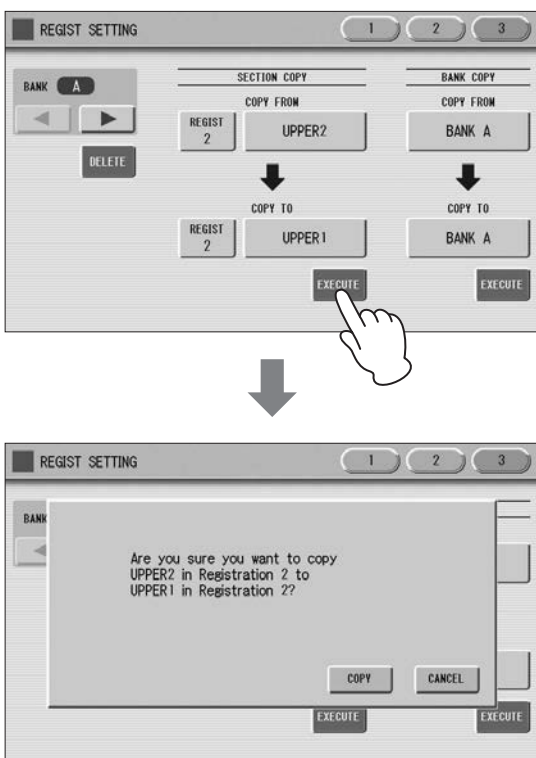

7 Press the [COPY] button in the display to copy the Registration and a message momentarily appears in the display indicating that the Registration has been copied.

Select [CANCEL] to abort the operation.

To copy a Bank:

You can also copy Registration data by Bank. To do this, select the source Bank in the COPY FROM area, select the destination Bank in the COPY TO area, then press the [EXECUTE] button at the right bottom in the display.

To delete the current Bank:

Press the [DELETE] button in the display.

NOTE

Data of Banks that follow the deleted Bank will be moved up to the previous Bank respectively. For example, deleting the Bank A will move the data of Bank B to Bank A, Bank C to Bank B, Bank D to Bank C, and Bank E to Bank D.

7 Music Data Recorder (MDR)

The Music Data Recorder (MDR) is a sophisticated recording system built into the Electone that lets you record your performances and Registration settings to a USB flash drive. Before using a USB flash drive, carefully read “Precautions when using the [USB TO DEVICE] terminal” section on page 110.

Calling Up the MDR Display

Press the [MDR] button in the panel to call up the MDR display. All operations related to the MDR, such as recording and playing your performances, can be done in the MDR display.

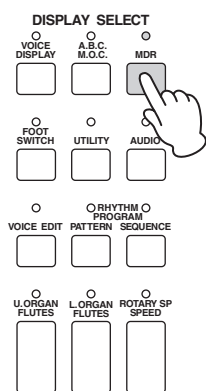

NOTE

The USB flash drives (USB 01, USB 02...) are shown in random order in the display.

Pressing any button other than the [MDR] button while the MDR display is open exits from the MDR display. If you exit from the function inadvertently, simply press the [MDR] button again to recall the MDR display.

All the instructions in this chapter are related to the MDR display. To call up the MDR functions and the MDR display, press the [MDR] button.

Using the MDR Display

The MDR display consists of two display pages: the SONG Page and the TOOLS Page. In the SONG Page, you can select a Song, then play it back or record it. The TOOLS Page has a variety of Song utility operations, such as copy, delete, rename, etc.

Pressing the [SONG] or [TOOLS] button at the top right of the display switches between the SONG Page and the TOOLS Page.

SONG Page

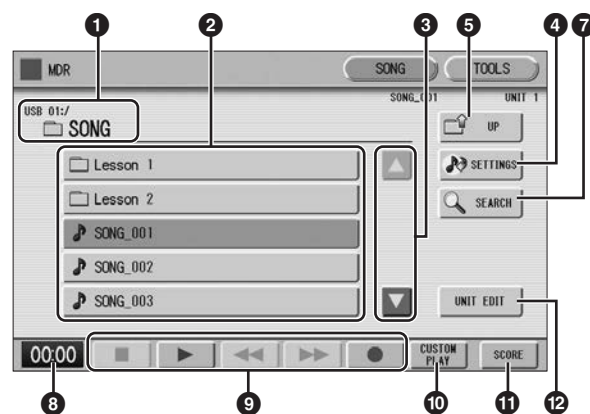

TOOLS Page

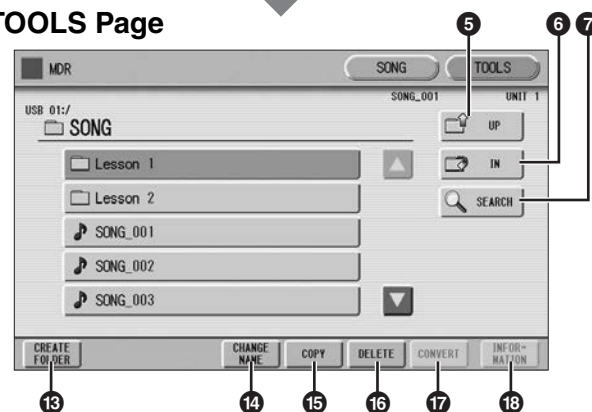

1 Current USB Flash Drive/Folder

Displays the currently selected USB flash drive and folder(s). The left side of the indication (before “:/”) shows the particular USB flash drive and the right side shows the path with the currently selected folder name at the end. For example, “USB 01:/Folder1/” indicates that the folder named “Folder1” contained in the USB flash drive is selected.

2 USB Flash Drive/Folder/Song List

Displays the USB flash drive, folders or Songs. Up to 120 folders can be displayed (5 folders at once).

3 Scroll buttons

If the USB flash drive/folder/Song list contains more than 5 USB flash drives/folders/Songs, you can scroll through the display with these buttons.

4 SETTINGS

Displays/changes the settings for the currently selected Song.

 **Reference page**

- About the [SETTINGS] button (page 112)

5 UP

Selects the higher layer folder or USB flash drive. For example, when “USB 01:/Folder1/” (Folder1 in the USB flash drive) is selected, pressing the [UP] button selects “USB 01:/” (USB flash drive).

6 IN

Selects the next lower (or deeper) layer folder or USB flash drive. For example, when “USB 01:/ Folder1/” (Folder1 in the USB flash drive) is selected, pressing the [IN] button selects “USB 01:/Folder1/SONG/” (the SONG folder contained in Folder1 of the USB flash drive).

NOTE

You can execute the same operation also by pressing the currently selected folder.

7 SEARCH

Search for the folder/Song in the selected USB flash drive.

 **Reference page**

- Searching for a Song (page 112)

8 Elapsed time

Displays the elapsed time when recording/playing back a Song (up to 99 min. 59 sec.).

9 Song control

Controls Song recording, playback, etc.

 **Reference pages**

- Recording your performance (page 114)
- Playing Back a Song (page 121)

10 CUSTOM PLAY

Records/plays back only the performance data of the selected Songs. Using this button does not recall the Registration data.

11 SCORE

Displays the selected Song’s score.

 **Reference page**

- Displaying the Score (page 124)

12 UNIT EDIT

Displays the Unit Edit display for the selected Song’s Registration data.

 **Reference pages**

- Saving Registrations and Other Data to a Unit (page 118)
- Recalling Recorded Registrations (page 120)

13 CREATE FOLDER

Creates a new folder in the USB flash drive/folder/Song list. Up to 120 folders can exist in one USB flash drive or within a single upper folder. Pressing this button calls up the New Folder display in which you can enter the desired name. Enter the name and press the [OK] button to create a new folder. The method for entering a folder name is the same as that of the Song name. See page 116.

14 CHANGE NAME

Changes the folder/Song name.

 **Reference page**

- Changing the Song Name (page 116)

15 COPY

Copies the selected USB flash drive/folder/Song.

 **Reference page**

- Song copy (page 126)

16 DELETE

Deletes the selected folder/Song.

 **Reference page**

- Song delete (page 128)

17 CONVERT

Converts the selected Song for use on another Electone or other instruments, or converts Songs recorded on another Electone for use on the ELS-02/ELS-02C. Songs can be converted to XG format, EL format or ELS format.

 **Reference pages**

- Converting to XG (page 129)
- Converting ELS format to EL (page 130)
- Converting EL format to ELS (page 131)

18 INFORMATION

Displays available memory when USB flash drive is selected and displays information such as the title and composer when a Song is selected. The information to be displayed depends on the Songs.

 **Reference pages**



- Checking the remaining memory (page 131)
- About Protected Songs (page 121)

If USB flash drive cannot be found:

- 1 Press the  (UP) button until the button is grayed out.

The USB flash drive list will be displayed. If there are more than five media selections, scroll through the display with the Scroll buttons (page 107) to display the desired USB flash drive.

If Songs cannot be found:

- 1 Check the current USB flash drive/folder (page 107).
- 2 If the desired Song is stored in the currently displayed folder, use the Scroll buttons (page 107) to display the Song. If the desired Song is stored in a different folder, use the  (UP) and  (IN) buttons to select the folder in which the desired Song is stored.







If you are not sure of the folder in which the desired Song is stored, search a Song by using SEARCH function (page 112).

NOTE

If the message "Registration data will be initialized" is displayed when you select a folder, press the [INITIALIZE] button. (The USB flash drive is not initialized.) The message will appear when recalling a Protected Song.

Song icons

These icons are shown when you select a USB flash drive, folder, and Song.

	Indicates a USB flash drive. This icon is displayed in the USB flash drive/folder list.
	Indicates a folder.
	Indicates that write-protect or copy-protect is effective for the USB flash drive.
	Indicates that performance data is contained in the Song.
	Indicates an XG-compatible Song.
	Indicates a Protected Original Song. See page 121 for details.
	Indicates a Protected Edit Song. See page 121 for details.

USB flash drive contents: Folders, Songs, and Files

Folders:

A folder is a storage location in the USB flash drive, used to organize multiple Songs in groups. If you've saved many Songs to a USB flash drive, it may be difficult to find the desired Song quickly. Organizing your Songs in folders, with similar Songs grouped together (for example, according to genre or tempo), makes it easier to find the Songs you want.

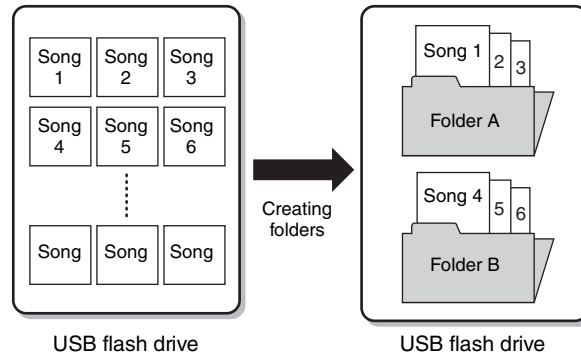

Songs:

A Song is the Electone data for a piece of music, recorded to USB flash drive. A single Song can contain a variety of data, including the recorded performance, Registrations, and so on.

Files:

A file is an element of data in a Song. For example, a single Song consists of various files, such as Registration files and performance files. The following files are created with the MDR (The extension will not appear in the Electone display. They will, however, be displayed on a computer.)

Files in the Song

File	Explanation	Extension
Performance data	This file contains performance data, played on the keyboards and pedals of the Electone.	.mid
Registration data	This file contains Registration settings, User Voices, User rhythms, and Rhythm Sequences.	.b00
XG-converted data	This file contains XG Song data, for which Electone performance data is converted to XG-compatible format.	.mid

In addition, one file (extension: .nam) is automatically created in each folder for organization/maintenance of the folder contents. It does not appear on the Electone display.

Precautions when using the [USB TO DEVICE] terminal

This instrument is equipped with the three [USB TO DEVICE] terminals as follows:

- Two [USB TO DEVICE] terminals in the USB Dock at the left front of the keyboard.
- One [USB TO DEVICE] terminal at the right side under the keyboard.

However, an ELS-01 series instrument with an installed STAGEA Vitalize unit is equipped as follows.

- Two [USB TO DEVICE] terminals at the right side under the keyboard.

NOTE

For more information about the handling of USB devices, refer to the owner's manual of the USB device.

Compatible USB devices

- USB flash drive
- USB wireless adaptor (which is included only in some areas)

Other USB devices such as a computer keyboard or mouse cannot be used.

Although USB devices 1.1 to 3.0 can be used on this instrument, the amount of time for saving to or loading from the USB device may differ depending on the type of data or the status of the instrument.

The instrument does not necessarily support all commercially available USB devices. Yamaha cannot guarantee operation of USB devices that you purchase. Before purchasing a USB device for use with this instrument, please visit the following web page: <http://download.yamaha.com/>

NOTE

- The rating of the [USB TO DEVICE] terminal is a maximum of 5V/500mA. Do not connect USB devices having a rating above this, since this can cause damage to the instrument itself.
- Only an ELS-01 series instrument with an installed STAGEA Vitalize unit can be used with one USB hub.

Connecting USB device

When connecting a USB device to the [USB TO DEVICE] terminal, make sure that the connector on the device is appropriate and that it is connected in the proper direction.

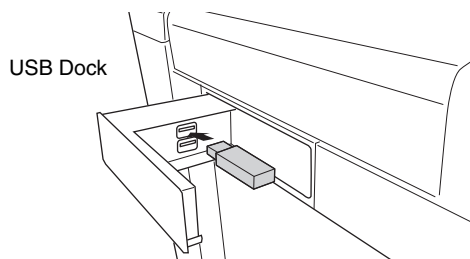

NOTICE

- Avoid connecting or disconnecting the USB flash drive while executing playback/recording and file management operations (such as Save, Copy, Delete and Format), or when accessing the USB flash drive. Failure to observe this may result in "freezing" of the operation of the instrument or corruption of the USB flash drive and the data.
- When connecting then disconnecting the USB flash drive (and vice versa), make sure to wait more than 6 seconds between the two operations.

NOTE

- An ELS-01 series instrument with an installed STAGEA Vitalize unit does not have a USB Dock installed. For details about the USB Dock, see page 186.
- When you use a USB device other than a USB flash drive, connect it to the [USB TO DEVICE] terminal on the right side under the lower keyboard.
- When connecting a USB cable, make sure that the length is less than 3 meters.

Using USB flash drives

By connecting the instrument to a USB flash drive, you can save data you've created to the connected device, as well as read data from the connected device.

Maximum number of USB flash drives allowed

Up to three USB flash drives can be connected to the [USB TO DEVICE] terminal.

Formatting USB flash drive

You should format the USB flash drive only with this instrument (page 111). A USB flash drive formatted on another device may not operate properly.

NOTICE

The format operation overwrites any previously existing data. Make sure that the USB flash drive you are formatting does not contain important data. Proceed with caution, especially when connecting multiple USB flash drive.

To protect your data (write-protect)

To prevent important data from being inadvertently erased, apply the write-protect provided with each USB flash drive. If you are saving data to the USB flash drive, make sure to disable write-protect.

Turning off the instrument

When turning off the instrument, make sure that the instrument is NOT accessing the USB flash drive by playback/recording or file management (such as during Save, Copy, Delete and Format operations). Failure to do so may corrupt the device and the data.

Formatting a USB Flash Drive

If you find that you are unable to use a new, blank USB flash drive or an old one that has been used with other devices, you may need to format it.

Formatting erases all the data in the USB flash drive and makes it ready to record. The data erased by formatting will be lost permanently. Check whether or not the USB flash drive contains any important data you wish to keep before executing the operation. Proceed with caution, especially when connecting multiple USB storage media.

NOTE

Before purchasing a USB flash drive, please consult your Yamaha dealer, or an authorized Yamaha distributor for advice, or see the Yamaha website:
<http://download.yamaha.com/>

- 1 **Connect the USB flash drive to the [USB TO DEVICE] terminal.**
- 2 **Press the [TOOLS] button at the top right of the display to call up the TOOLS Page.**
- 3 **Press the  (UP) button repeatedly if necessary until the button is grayed out.**
- 4 **Select the desired USB flash drive you want to format.**

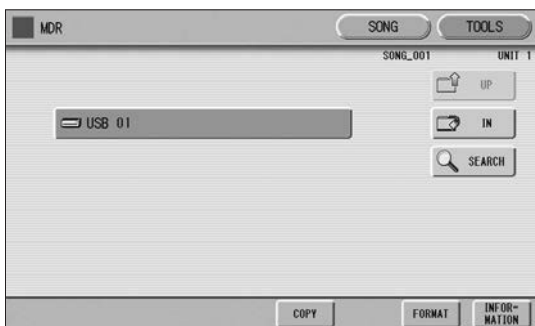

The indications USB 01, USB 02, etc. will be displayed depending on the number of the connected USB flash drives.

- 5 **Press the [FORMAT] button in the display.**

A message appears, prompting confirmation of the operation. Select [FORMAT] to format the USB flash drive, or [CANCEL] to abort the operation.

NOTICE

Do not remove the USB flash drive while formatting.

Selecting a Song

In the MDR display, you can select a blank Song to which you want to record your performance or save the Registration settings, or you can select a desired Song for playback.

In the MDR display, Songs in the currently selected USB flash drives are displayed.

First call up the desired USB flash drive (and folder, if necessary) in the display, then select the desired Song.

1 Check the currently selected USB flash drive at the top of the display.

Confirm that the desired USB flash drive is displayed at the top of the display.

Currently selected USB flash drive/folder

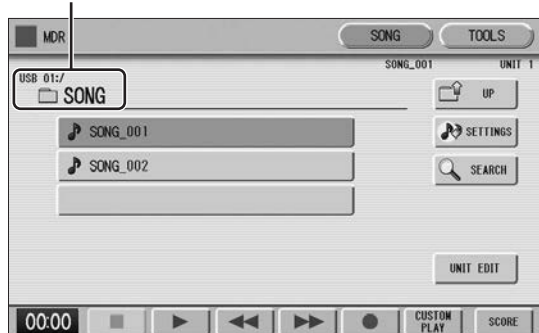

NOTICE

Do not remove the USB flash drive while it is being accessed by the instrument. (If you are using a USB flash drive which has a lamp, the lamp will flash when the instrument is accessing the USB flash drive.)

For information on selecting the desired USB flash drive, see page 108.

2 Press desired Song button in the display.

Referring to the Song name and icons, select the desired Song. The selected Song button is highlighted in orange.

Song containing data



Blank Song (containing no data)

Reference pages

- Changing the Song Name (page 116)
- Song icons (page 108)

About the [SETTINGS] button

Pressing the (SETTINGS) button calls up a display of the currently selected Song, letting you confirm the tempo and parts that are played when playing the Song.

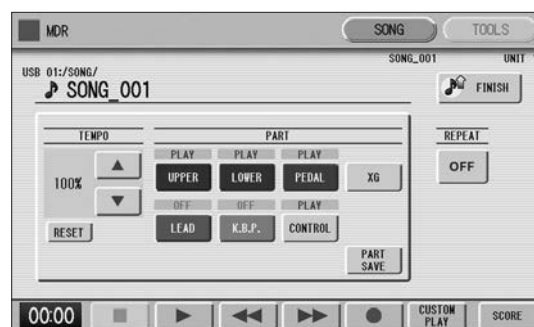

When playing back the Song (by pressing the [▶] (Play) button), only those parts that are set to “PLAY” in the display actually play at the indicated tempo (over a range of 50% to 200% of the original tempo when recording). If the Song contains no performance data, all parts are set to “OFF.” Pressing the [PART SAVE] button saves each part playback setting (the tempo is not saved).

Reference pages

- Playing back the selected part(s) (page 122)
- Changing the tempo (page 123)

Searching for a Song

Search for a desired Song by using the Search function.

1 Insert the USB flash drive containing the desired folder/Song.

2 Select the USB flash drive containing the folder/Song.

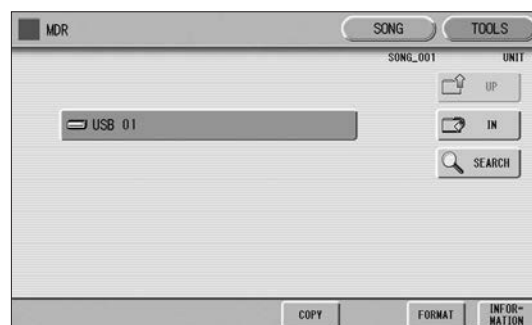

NOTE

Regardless of the current path, the Search operation will be applied to the entire contents of the USB flash drive.

3 Press the [SEARCH] button in the display.

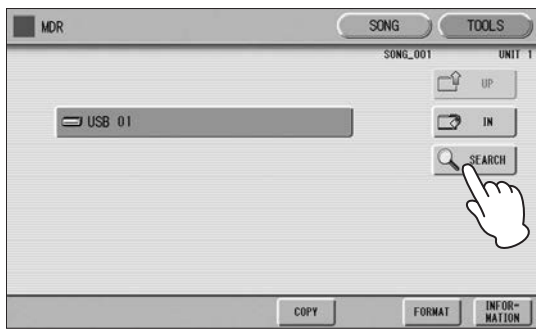

NOTE

Previous searched data can be shown on the display. However, the data does not appear if you've turned off the power, removed the USB flash drive or saved the Song after performing the search operation.

4 Press the [KEYWORD] button.

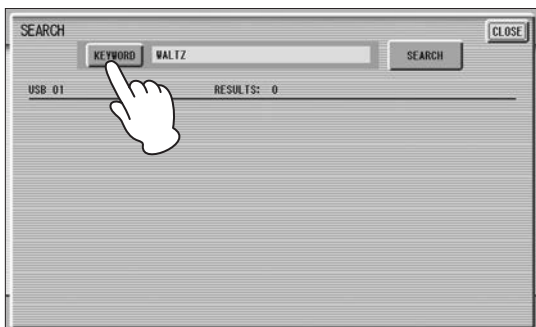

Previous key word



5 Enter the folder/Song name for searching.

If necessary, press the [DELETE] button so that the previous key word can be deleted, then enter the new key word. (See page 116 for instructions on changing the Song name.)

NOTE

- This function does not distinguish between capital and lowercase letters.
- When searching for XG Songs, entering the extension ".mid" is unnecessary.

6 Press the [OK] button.

The search will begin, and the detected folder/Song name will be shown on the display.

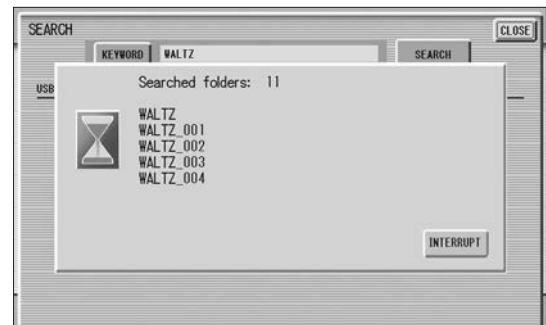

To cancel the Search operation, press the [INTERRUPT] button.

7 Confirm the detected folder/Song name.

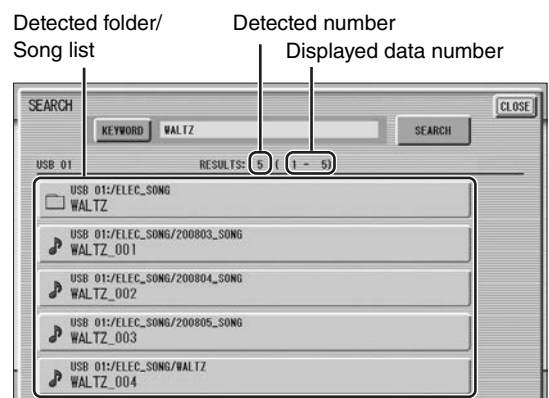

8 Press the desired folder/Song.

The display will automatically exit from the SEARCH display and the selected folder/Song appears.

If nothing is detected, try the search again by using another name (see step 4 above).

Recording

Recording your performance

Set the desired Registrations on the Electone. Make all the Electone settings necessary for the Song you will record. This means entering the all Registrations you will need for the entire performance in the Registration Memory. Make sure also to select the Registration that you will use at the beginning of the Song.

NOTICE

Never attempt to remove the USB flash drive or turn the power off during recording, reading or playback.

- 1 Insert a USB flash drive to the [USB TO DEVICE] terminal.
- 2 Select a blank Song for recording your performance.
For details on selecting a Song, see page 112.
If you want to overwrite an existing Song already containing performance data, you will need to delete it beforehand.
- 3 Press the [SONG] button at the top right of the display to call up the SONG Page, then select the [●] (Record) button.

The following display appears, indicating that you can record your performance.

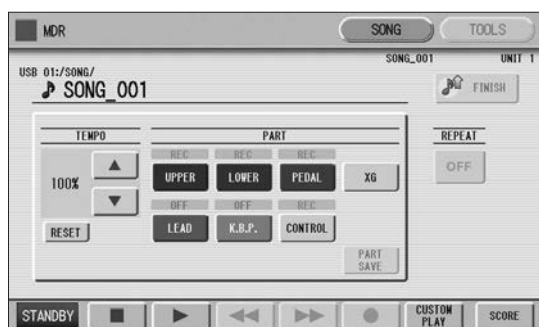

NOTE

If a message appears indicating there is not enough free space in USB flash drive, press the [CANCEL] button, then delete any unnecessary Songs if possible or insert new USB flash drive. To continue recording your performance on USB flash drive that does not have enough space, press the [CONTINUE] button.

- 4 Press the [▶] (Play) button.

An hourglass icon appears at the bottom left of the display, indicating that Registration data is currently being read.

NOTE

Regardless of the currently selected Unit number, the recording operation will save data other than your performance to the first Unit of the Song. This is why pressing the [●] (Record) button will call up the dialog to confirm whether OK or not to save data to the first Unit when the Registration Unit other than the first Unit is loaded. In this situation, pressing [OK] will go to the Recording Standby mode while pressing [CANCEL] will exit from the Recording mode.

- 5 After the hourglass disappears, begin playing.

- 6 When you finish playing, press the [■] (Stop) button in the display.

The recording is finished and the LCD returns to the MDR display. The Song to which your performance is recorded is automatically named "SONG_XXX" (XXX indicates Song number). You can change the Song name as desired. (For details, see page 116.)

NOTICE

Do not remove the USB flash drive from the Electone while data is being recorded (while the hourglass icon or other message is shown).

Re-recording (Retry)

If you make a mistake during recording, you can re-record the Song from the beginning.

- 1 Press the [●] (Record) button while the Song is still running.

This automatically stops recording and returns you to the starting point of the Song.

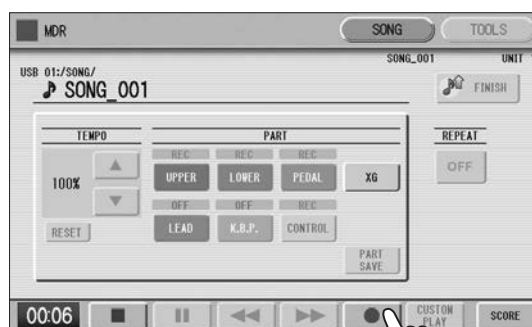

2 Press the [▶] (Play) or [CUSTOM PLAY] button to begin rerecording the Song.

Re-recording starts from the beginning of the Song and replaces the previously recorded performance with the newly recorded performance.

NOTE

Pressing the [■] (Stop) button cancels the re-recording and records the previous performance.

Recording specified parts only

You can also record the parts of your performance independently. This function lets you record Keyboard Percussion and performance control data, such as Registration changes and expression pedal operation, separately from the other parts of the Song. Even Keyboard Percussion 1 and Lead Voice 1 Voices can be recorded separately, though, the Lead Voice 2 Voices will be included in the performance data of the Upper Keyboard. The following instruction is an example: First, record the chords and bass to the Song using the Lower and Pedalboard, and then record the melody using the Upper Keyboard.

NOTE

The Lead Voice 2 and the Keyboard Percussion 2 cannot be recorded to each part separately.

1 Follow steps 1 – 3 on page 114 to call up the Rec Standby display.

2 Select the parts for recording.

Each pressing of a part button switches the status: PLAY, OFF, and REC.

PLAY: Playback the parts that have been recorded.

OFF: Recording or playback is not active.

REC: Records the part.

If you set the Upper part to “REC,” the performance on the Upper Keyboard (including Lead Voice 1 Voices) is recorded. Setting Lead to “REC,” however, records only the Lead Voice 1 Voices. You cannot set both Upper and Lead to “REC” at the same time; neither can the Lower and Keyboard Percussion parts be recorded at the same time.

NOTE

When you record the Keyboard Percussion, make sure that the KEYBOARD PERCUSSION [1] button is set to on.

The following setting lets you record only Lower Keyboard and Pedalboard parts.

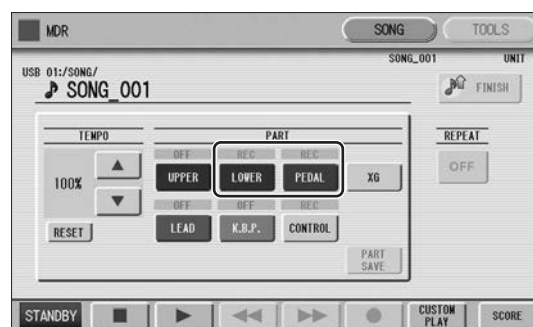

NOTE

You should also set the Control button to “REC,” in order to record Registration changes and expression pedal operation.

3 Press the [▶] (Play) button, and start playing after the hourglass icon disappears.

4 Press the [■] (Stop) button when you are finished with your performance to stop recording.

Now you’ve recorded the first parts of your performance.

5 Press the [●] (Record) button to set up recording of the next part — Upper part in this case.

A message appears prompting confirmation of operation. Select [OVERWRITE] to overwrite and the Rec Standby display appears.

6 Select the parts for recording.

Set the next parts you want to record (in this case, the Upper part) to “REC.”

Also set the part already recorded (in this case Lower and Pedal parts) to “PLAY,” so you can hear the previously recorded parts as you record new ones.

7 Change the playback tempo for the selected part.

The playback tempo can be set over a range of 50% to 200% of the original.

The original recorded tempo is 100%; values less than 100% result in a slower tempo while values greater than 100% result in a faster tempo.

NOTE

Use the TEMPO [RESET] button in the display to reset the tempo to its original value (100%).

8 Press the [CUSTOM PLAY] button to start recording of the part selected in step 6 (Upper part).

Playback of the previously recorded parts starts immediately.

The [CUSTOM PLAY] button is used here to record only the parts that have been selected for recording, and plays back only those parts that have been selected for playback. While you listen to the parts being played back, start playing the melody on the Upper Keyboard.

When the end of the recorded performance is reached, playback is automatically stopped. The length of a subsequently recorded part cannot exceed the length of the previously recorded parts.

Punch-in recording

This lets you re-record a specific phrase or section which you don't want to use, either that of a specific part(s) or all parts.

NOTE

This function is best used when the phrase to be re-recorded has definite beginning and end points, with slight pauses before and after.

1 Select the Song which contains the phrase you want to change.

For details on selecting a Song, see page 112.

2 Press the [▶] (Play) button to start playback of the Song.

3 Press the [||] (Pause) button at the point you want to execute punch-in recording.

4 Press the [●] (Record) button.

The Recording display appears, indicating that the Music Data Recorder is ready to record.

5 Set the parts which you want to change to "REC" status and other parts to "PLAY."

6 Press the [▶] (Play) button to start punch-in recording. Play the new phrase, as you want it to be changed.

7 Press the [■] (Stop) button to quit the punch-in recording as soon as you reach the end of the phrase.

Changing the Song Name

You can name the Song, such as giving it a title or indicating the date on which it was recorded. However, Song names of EL-series Electones, such as the EL-900, cannot be changed.

NOTE

When you change the name of an XG Song, the extension (.mid) cannot be changed.

1 Select the Song whose name you want to change.

For details on selecting a Song, see page 112.

2 Press the [TOOLS] button at the top right of the display to call up the TOOLS Page.

3 Press the [CHANGE NAME] button.

The following display appears.

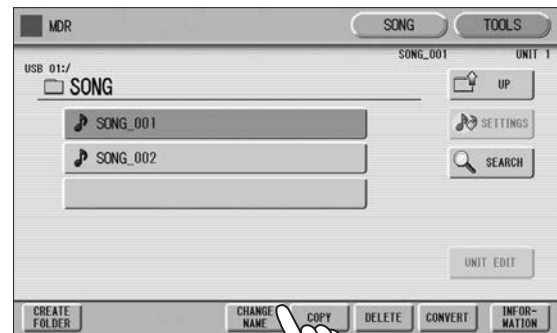

4 Move the cursor to the desired point by using the [◀] [▶] buttons in the display or the Data Control dial.



5 Select the desired character type: alphabet, upper or lowercase, or symbol.



NOTE

If you select Japanese as the Language in the Utility display (page 16), you can also select Japanese language characters (hiragana and kanji, normal size katakana, half size katakana, full size alphabet, and full size symbols).

6 Select the desired character for entry.

A Song name can contain up to 50 characters.

NOTE

An XG Song name can contain up to 46 characters.

7 After finished, select [OK] to actually enter the name.

The LCD will return to the TOOLS Page display.



To delete an entered character:

1 Move the cursor to the character you want to delete.



2 Press the [DELETE] button at the bottom right in the display.

The character is deleted.

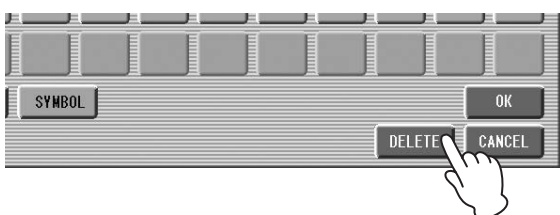

To convert into kanji (Japanese language):

This applies only if you are using the **かな漢** (Kana-Kan) button in Japanese.

1 When the input “Hiragana” characters are shown in the reverse display (highlighted), press the **漢字変換 (kanji-conversion) button once or several times to convert to the characters into the appropriate kanji.**

- The reversed area can be changed by the [**◀**] [**▶**] buttons in the display or the Data Control dial.
- The converted area can be cleared at once by pressing the **キャンセル** (cancel) button.

2 To actually enter the change, press the [OK] button or enter the next character. To enter the hiragana character itself (without converting it), press the **削除 (delete) button.**

A “name is not available” message may appear when you press the [OK] button to finish entering the name. If this message appears, the name is invalid and you should enter another name.

NOTE

Songs are ordered in the following sequence: symbol, number, alphabet, hiragana, kanji, other symbols. Names with an asterisk (*) at the top are exceptions to this rule.

The following names cannot be used. (“xx” indicates numbers.)

MDR_xx.EVT	SONG_xxx
MDR_xx.MID	MDR_xxx.TMP
MDR_xx.Bxx	REG_xxx.TMP
MDR_xx.Vxx	ELS_SONG.TMP
SONG.NAM	SONG_xxx.C02
ELS_SONG.NAM	TMP
MDR_xxx.MID	TMPE02
REG_xxx.B00	

Saving Registrations and Other Data to a Unit

You can also record Registration Memory data and other created data without recording a performance, as listed below. The data will be saved to a Unit (page 98) of the selected Song.

- Registration Memory related data (including the Registration Shift settings)
- VA Custom Voice data (only for ELS-02C) and User Voice data
- Keyboard Percussion data
- User Rhythm data
- Rhythm Sequence data

1 Select the destination (blank Song) to which the created Registration Memory data and other data will be saved.

For details on selecting a Song, see page 112.

2 Press the [UNIT EDIT] button at the lower right section in the display to call up the Unit Edit display.

3 Make sure that all data types you want to load are selected, then press the [SAVE] button, followed by the [CLOSE] button in the display.

A message appears on the display, indicating the data is currently being saved.

After the message disappears, press the [CLOSE] button to return to the SONG page, then “SONG XXX” (XXX: number) is assigned as Song name to the destination Song.

Creating two or more Registration Units in a Song

When you want to use various Registrations exceeding five Registration Banks (one Unit), you should save additional Registration Units to a Song.

Reference pages

- Next Unit (page 100)
- Programming a Registration Sequence (page 174)

1 Select the destination Song which includes Registration data.

For details on selecting a Song, see page 112.

2 Press the [UNIT EDIT] button at the right lower section in the display to call up the Unit Edit display.

At the left side in the display, the Registration Unit list of the current Song is shown, such as “UNIT 1” and “UNIT 2.”

3 Press the blank button at the lowest position of the Registration Unit list.

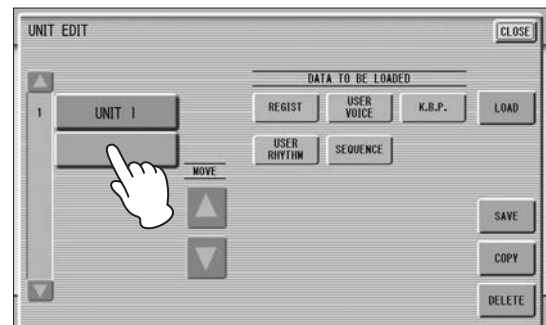

4 Press the [SAVE] button.

This operation will add a new Unit next to the lowest Unit.

NOTE

The above operation will simply create a new Unit which will not be called up via Song playback, etc. To call up the newly created Unit, set the order of the Registration Unit (page 119), then make the Next Unit settings of Registration Shift (page 99) and Registration Sequence (page 174). Note that changing the Unit via the Next Unit may result in no sound from the Electone for a few seconds when User Voice data and VA Custom Voice data differ between the current Unit and the next Unit.

Overwriting Registration data to a Unit

This operation lets you replace just the Registration Unit without changing the performance data in already recorded Song data.

1 Select a Song containing the performance data.

For details on selecting a Song, see page 112.

2 Press the [UNIT EDIT] button in the display to call up the Unit Edit display.

The Registration Unit list is shown.

3 Select the Registration Unit you wish to overwrite.

4 Press the [SAVE] button.

A message appears, prompting confirmation of overwriting the Registration Unit. Press [OVERWRITE] to overwrite (replace), or press [CANCEL] to abort the operation.

NOTE

Also with the following operations, only Registrations and other data (excepting performance data) can be recorded.

1. Select the desired Song number to which you want to record.
2. Press the [●] (Record) button to set recording to standby.
3. Press the [▶] (Play) button, then press the [■] (Stop) button without playing the keyboard.

Changing the order of the Registration Units

To call up another Registration Unit from the Registration Shift (page 99) and Registration Sequence (page 174) as the Next Unit, you should change the order of the Registration Units as desired on the Unit Edit display.

NOTE

The first Unit (located at the top) will be called up first after Song playback starts.

1 From the SONG page, select a Song which contains two or more Registration Units.

For details on selecting a Song, see page 112.

2 Press the [UNIT EDIT] button in the display to call up the Unit Edit display.

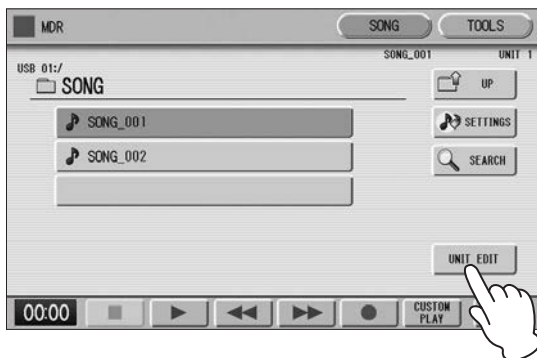

3 Change the order of the Registration Units.

From the Registration Unit list at the left end in the display, select the desired Unit then use the MOVE buttons to move the order of the selected Unit.

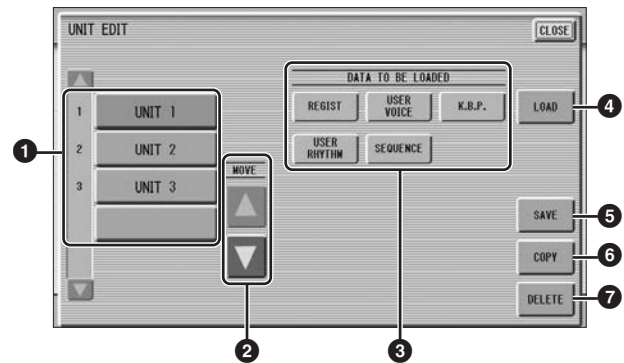

1 Registration Unit list

Lists the Registration Units included in the current Song. When the current Song contains five or more Registration Units, the scroll button ▲ ▼ can be used to scroll through the Registration Unit list. The selected Unit is highlighted in orange.

2 MOVE buttons

Moves the Registration Unit selected at 1 up or down one by one.

3 DATA TO BE LOADED

When loading the Registration Unit selected at 1, use these buttons to select only the desired data. For more information, see page 120.

4 LOAD

Loads the Registration Unit selected at 1 according to the settings of 3.

5 SAVE

Saves the Registration Memory data to the Registration Unit selected at 1.

6 COPY

Creates the copy of the Registration Unit selected at 1, and then locates the copied Unit at the bottom of the Registration Unit list (1).

7 DELETE

Deletes the Registration Unit selected at 1.

4 Press the [CLOSE] button at the top right in the display to close the Unit Edit display.

Recalling Recorded Registrations

Registrations (and bulk data) recorded to Song numbers can be easily loaded back to the Electone by the following procedure. The MDR independently recalls the following five types of data:

- REGIST
- USER VOICE
- K.B.P.
- USER RHYTHM
- SEQUENCE

You can select and recall the desired data independently.

1 Insert the USB flash drive and select the Song you want to load back to the Electone.

For details on selecting a Song, see page 112.

2 Press [UNIT EDIT] button in the display to call up the Unit Edit display.

3 Select the Unit you want to load to the Electone.

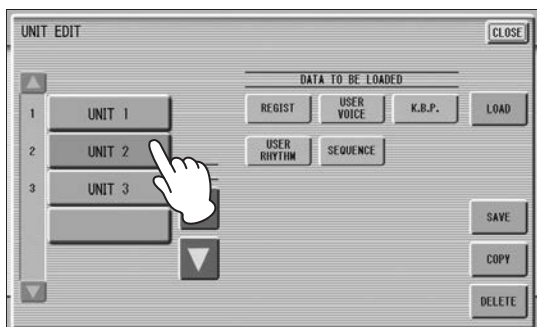

4 Using the five “DATA TO BE LOADED” buttons, select the desired data you want to load.

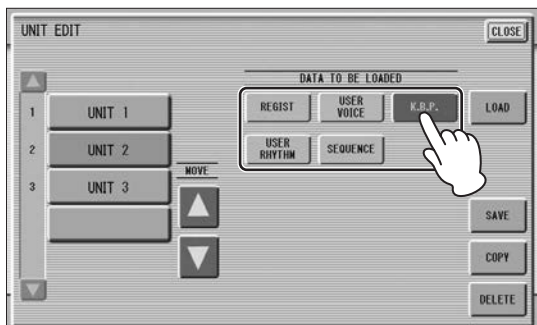

NOTE

When you load the Registration data by using the Next Unit function, all data will be loaded no matter which buttons you select here.

5 Press the [LOAD] button.

A message appears, prompting confirmation of the operation. Press the [LOAD] button to load the Registration data.

Press [CANCEL] to cancel the operation.

NOTE

If you load a Registration while a rhythm is playing, sequence data and User rhythms in the Registration data cannot be loaded.

6 Exit from the Unit Edit display by pressing the [CLOSE] button at the top right of the display.

When you select the Protected Song, the buttons (DATA TO BE LOADED) may be unavailable (grayed out). For example, combining a part of one Protected Song with another Protected Song is not allowed.

About Protected Songs

If you buy or download Song data, it may be protected so that you cannot delete or copy, in order to prevent accidental erasure or protect copyright. These are called Protected Songs. Protected Songs can be saved to a USB flash drive confirmed by Yamaha. A Protected Song can be played back in the same way as Songs you've created, but it cannot be converted to XG format or EL format. It is not possible to edit the Registration data in the Protected Song, nor can the performance data be overwritten. If you want to edit a Protected Song, first copy it within one USB flash drive/folder, then edit the copy. (You cannot copy to another USB flash drive/folder.) The copied Song (called "Protected Edit Song") is available only when the original Song (called "Protected Original Song") exists in the same folder. Be careful not to delete the Protected Original Song.

NOTICE

When you want to edit a Protected Song, first initialize the Registration Memory, then select the desired Song. If you have not initialized the Registration first, the edited Song may not be saved.

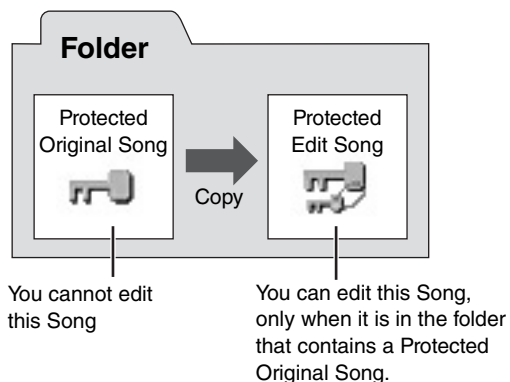

NOTICE

To move the Protected Song in a USB flash drive with a computer, you'll need to use the Musicsoft Downloader application. If you move the Song without Musicsoft Downloader, the Song cannot be played back. Musicsoft Downloader can be obtained at the following Internet address: <http://download.yamaha.com/>

Playing Back a Song

This section describes how to play back a Song recorded with the MDR and the commercially available Song data which can be played back with the MDR

1 Select the Song to be played back.

For details on selecting a Song, see page 112.

2 Press the [▶] (Play) button in the display to start playback.

When the Song contains only the Registration data (without performance data):

Depending on the Song, no note icon is shown by the file name, indicating that only Registration data is included and there is no performance data.

Starting playback of such a Song will load only Registration data (an hourglass icon appears), and then return operation to the SONG page.

When a Song contains both Registration data and performance data:

Starting playback of such a Song will load only Registration data (an hourglass icon appears), and then begin actual playback of the performance data.

When the Song contains only the performance data:

Starting playback of such a Song will start playback of the performance data immediately.

Reference page

- Changing the order of the Registration Units (page 119)

3 When you want to stop playback, press the [■] (Stop) button on the display.

Although playback will stop automatically as soon as playback position reaches to the end of the Song data, you can stop playback at the middle of the performance data by pressing the [■] (Stop) button on the display.

NOTE

- When two or more Units are included in the current Song, starting playback will load the Registration Unit shown at the top in the Unit Edit display.
- Registration data is generally not included in most Song data, such as commercially available XG Songs created on instruments other than the Electone.

Custom Play

If you want to play back a Song without resetting the Registrations, press the [CUSTOM PLAY] button instead of the [▶] (Play) button. This displays the Song time and starts playback immediately.

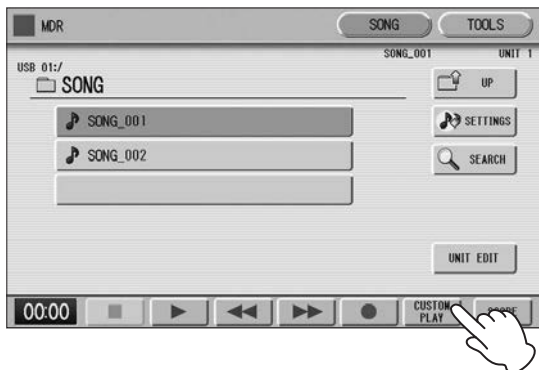

When you play a Song using the Next Unit function, always press the [▶] (Play) button to start the Song, not the [CUSTOM PLAY] button.

Playing back the selected part(s)

You can also play back selected parts of your recorded performance, while other parts are temporarily turned off. This function is especially useful for playing a single part, such as the melody, over previously recorded accompaniment parts.

To play back the selected part(s):

During playback or in the Settings display, press each part button to turn the part you want to playback to “PLAY” and the part you want to mute to “OFF.” Each pressing of a part button switches the status between PLAY and OFF. Pressing the [PART SAVE] button saves each part’s playback status.

Reference page

- About the [SETTINGS] button (page 112)

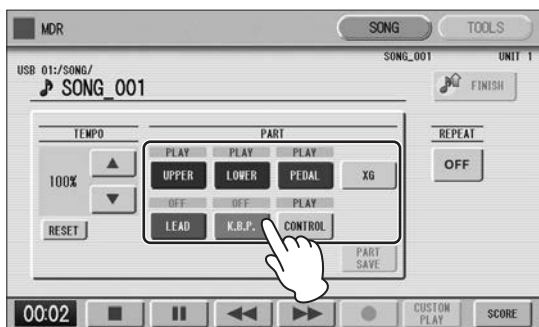

To play back the selected part(s) of XG-compatible Song data:

Press the Part [XG] button while XG-compatible Song data is being played back.

The following XG PART SETUP display appears.

Reference page

- Converting to XG (page 129)

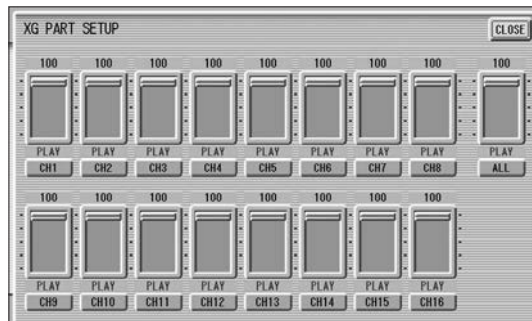

Press the appropriate channel buttons (e.g., the [CH1] button) to set each channel to playback or mute. Each pressing of a button switches the status: PLAY and OFF. Set a part to [PLAY] if you want it to play back and [OFF] if you do not.

The [ALL] button enables you to switch all channels to PLAY/OFF at once.

To set each channel’s volume use the sliders. Each channel’s volume can be adjusted between 0 and 100. The [ALL] slider adjusts the overall volume.

Fast forward, Rewind and Pause

Fast forward and Rewind:

During playback, press the [▶▶] (Fast forward) button or [◀◀] (Rewind) button and hold it down until the time reaches the desired position.

Even when the button is released, playback is paused. To resume playback from the point you’ve advanced or reversed to, press the [▶] (Play) button or [CUSTOM PLAY] button.

Pause:

If you want to temporarily stop playback of the Song or Songs, press the [⏸] (Pause) button.

To resume playback from the point at which the Song was paused, press the [▶] (Play) button or [CUSTOM PLAY] button.

Changing the tempo

You can change the tempo of the Song as the Song is playing in the MDR display, either while the Song is stopped or while it is playing.

NOTE

The tempo cannot be set for a Song containing no performance data.

To change the tempo:

Use the TEMPO ▲ ▼ buttons in the display or the Data Control dial to change the tempo. (The TEMPO dial on the panel cannot be used to change the tempo for the Music Data Recorder.) The range is 50 – 200%. The original recorded tempo is 100% and values less than 100% indicate slower tempo; values greater than 100% indicate faster tempo.

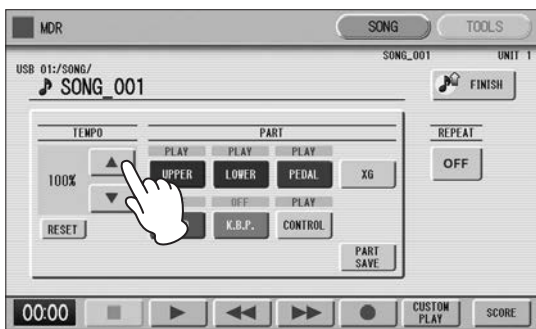

To reset the changed tempo:

Use the TEMPO [RESET] button in the display to reset the tempo to its original value (100%).

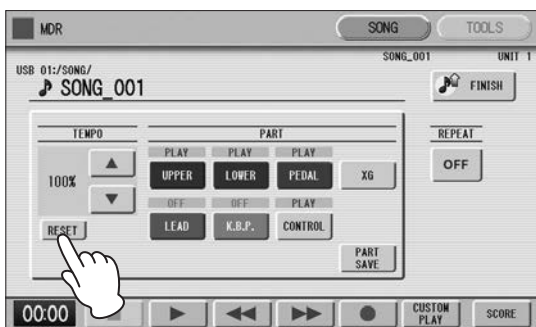

Repeat playback

This feature allows you to repeatedly play back either all Songs in a folder or only one specific Song.

- 1 **Select the Song you wish to play back.**
If you wish to play back all Songs in a folder, select the first Song that will be played back. For details on selecting a Song, see page 112.
- 2 **Press the [SONG] button at the top right of the display to call up the SONG Page.**
- 3 **Press the  (SETTINGS) button on the panel to call up the Settings display.**

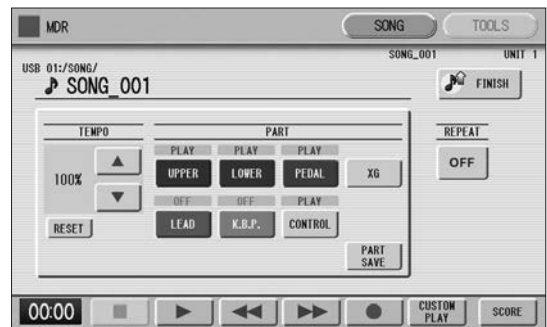
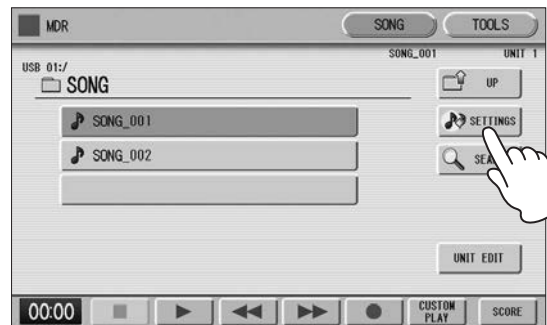

- 4 **Press the REPEAT button to select the repeat mode.**
Each press of the button switches among the modes.

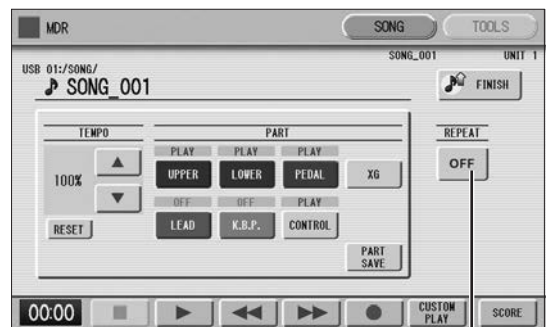

REPEAT button

7 Music Data Recorder (MDR)



SINGLE

Repeats the currently selected Song indefinitely.



ALL

Repeats all Songs in the currently selected folder in order.



RANDOM

Repeats all Songs in the currently selected folder randomly.



OFF

Cancels repeat playback.

- 5 **Exit from the Settings display by pressing the (FINISH) button at the top right of the display.**
- 6 **Press the [▶] (Play) button in the SONG Page to begin playback.**

Displaying the Score

The MDR display can display music notation (score) of the performance data recorded to USB flash drive. You can change the size and the number of staves to be displayed.

While a Song is being played back, the cursor moves according to the performance and the pages are automatically turned.

- 1 **Select the Song containing performance data.**
For details on selecting a Song, see page 112.
- 2 **Press the [SCORE] button in the display.**
The currently selected Song score will be displayed.

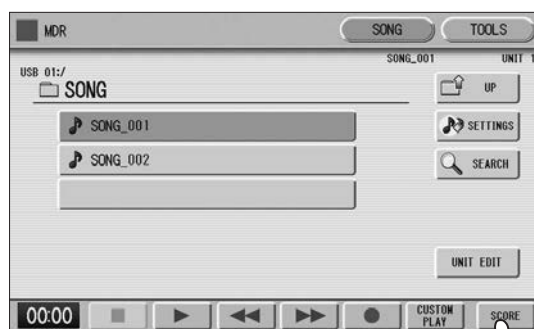

NOTE
Scores for Protected Songs cannot be displayed, excepting those Songs that specifically allow score display.

- 3 **Press the [▶] (Play) button in the display to start playing back the Song.**
As the Song plays back, the cursor moves accordingly and the page is automatically turned at the appropriate point.

In this condition, pressing the [●] (Record) button in the display lets you record a Song and have the score displayed for you.

The score size can be adjusted by pressing the [SIZE CHANGE] button in the display. Each press of the [SIZE CHANGE] button alternates the score size in the following sequence: normal, large, extra large, small, normal, and so on.

Please note that the size cannot be changed while a Song is being recorded.

NOTE

The score size setting cannot be stored to a Registration Memory.

- 4 You can manually turn score “pages” by first stopping playback of the Song by using the [■] (Stop) or [⏏] (Pause) button, and then pressing the PAGE [◀] or [▶] buttons in the display.

Pressing these buttons moves to the previous or next page. The PAGE [▶] button can be assigned to the left foot switch (page 125).

- 5 To exit the score, press the [SCORE OFF] button in the display.

Changing the score contents and settings

The Score Settings display lets you choose the contents to be displayed. In this display, you can also assign the Next Page function to the left foot switch:

- 1 Display the score.
- 2 Press the [SET UP] button in the display to call up the SCORE SETTINGS display.

NOTE

Please note that the score settings cannot be changed while the Song is being recorded. The [SET UP] button is disabled during recording.

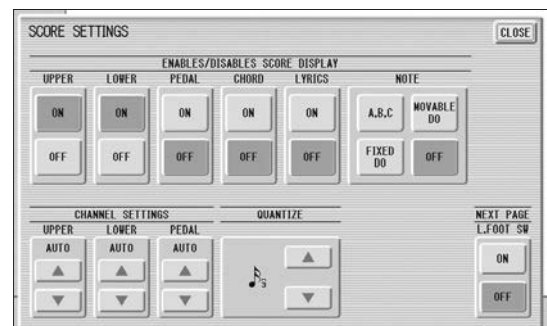

- 3 Change the score settings.

To set whether a specific part is displayed or not in the score, press the appropriate [ON] or [OFF] buttons of each part. Please note that at least one of the upper keyboard, lower keyboard or pedalboard will be set to [ON].

Available settings for notes and how they will be displayed (NOTE) include [A, B, C] (conventional C-D-E indications), [FIXED DO] (solfeggio), [MOVABLE DO] (relative solfeggio) and [OFF].

For the CH SETTINGS, the upper keyboard, lower keyboard and pedalboard can be assigned to the channels with the [▲] and [▼] buttons. You can

also use the Data Control dial to select channels after pressing the [▲] or [▼] button. Selecting [AUTO] automatically assigns parts to the channels according to the Song data.

To set the QUANTIZE value use the [▲] and [▼] buttons. You can also use the Data Control dial to select channels after pressing the [▲] or [▼] button. The shorter the selected note value, the more precisely the score is displayed.

Setting the NEXT PAGE L. Foot SW [ON] lets you turn the score to the next page with the left foot switch. You can also turn the score to the next page with the PAGE [▶] button in the display. If rhythm, glide and/or rotary speaker are assigned to the left foot switch and set on, both the assigned functions and the Next Page function work.

NOTE

- The score display settings cannot be stored to a Registration Memory. However, the ON/OFF setting of turning pages using the left foot switch can be saved to the Unit as Registration data common to all the Registration Memory numbers.
- Setting the NOTE to [MOVABLE DO] displays each key note as "Do."



Reference page

- About Quantize (page 155)

4 Exit from the SCORE SETTINGS display by pressing the [CLOSE] button at the top right of the display.

Other Functions (Tools)

The TOOLS Page in the MDR display has many functions, such as Song copy, Song delete, etc.

Song copy

This function lets you copy a folder/Song. You can copy and exchange the data even between two different USB flash drives. (For Songs created on EL-series instruments, such as the EL-900, one-by-one copy cannot be executed.) Make sure to check the remaining memory of the destination media in advance.

NOTE

- If the folder already contains 120 XG Songs the Songs can not be copied, or if the folder already contains 120 folders the folder can not be copied.
- A Song having a name/path that is too long may not be copied to the root directory, even if the amount of folders/XG Songs has not reached the maximum capacity.
- The Copy operation is automatically stopped if there is an unrecognizable file in MDR

Moving a Protected Song

A Protected Song can be copied within a folder, but it cannot be copied to another folder or USB flash drive. If you specify another folder or USB flash drive as the copy destination, a message appears prompting moving of the Song — but not copying. When the [MOVE] button is pressed, the Protected Original Song and all Protected Edit Songs which come from the same Protected Original Song will be moved together. This effectively "moves" a Protected Song, but does not "copy" it.

If you copy a folder which contains both Non-protected Songs and Protected Songs, the copy operation will be automatically executed for only Non-protected Songs, and Protected Song will be moved (not copied).

NOTE

If you copy a Protected Song to the same folder as the source Song, the copied Song will be the Protected Edit Song.

To copy a Song:

You can copy Song data within the USB flash drive, and also to another USB flash drive.

Connect the USB flash drive containing the Song and (if necessary) a USB flash drive for the copy destination to the [USB TO DEVICE] terminals, then follow the instructions below.

NOTICE

Insert the USB flash drive to the [USB TO DEVICE] terminal firmly. If the USB flash drive is not inserted firmly, the data may be lost.

1 Select the folder/Song/USB flash drive to be copied.

For details on selecting a Song, see page 112.

2 Press the [TOOLS] button at the top right of the display to call up the TOOLS Page.

3 Press the [COPY] button in the display to call up the COPY TO display.

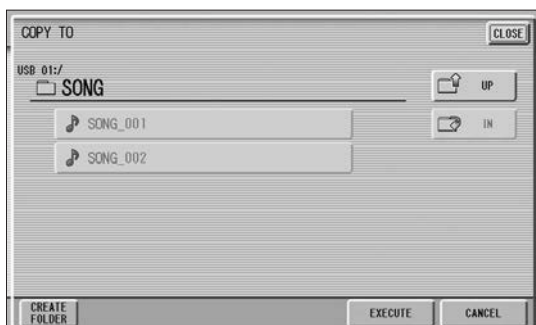
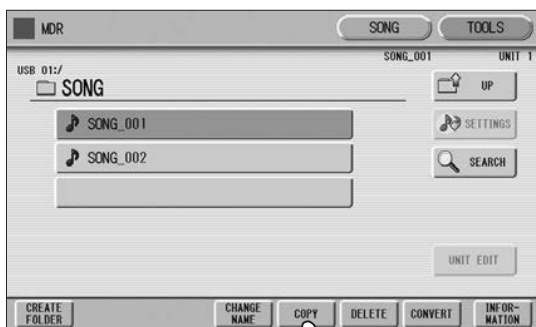

4 (If necessary) Change the destination.

For details on changing the destination, see page 112.

5 Press the [EXECUTE] button to execute the copy.

The folder/Song name in the destination is the same as the one of the source Song. If you copy a folder/Song to a folder that contains a Song whose name is the same as the source Song, the copied name will be "source Song name_XXX" (XXX indicates Song number). If you want to change the folder/Song name, see page 116.

If you copy an XG-compatible Song to another folder or USB flash drive that contains a Song with the same name as the source Song, a message appears prompting confirmation of overwriting the Song. Selecting [OVERWRITE] overwrites the XG-compatible Song in the destination.

NOTICE

- Never attempt to eject the USB flash drive or turn the power off during copying (or moving a Protected Song). Data may be lost.
- Removing the USB flash drive during operation may result in loss of the data. Never attempt to remove the USB flash drive unless the "Eject the source media" message appears.

NOTE

- While the copy operation is in progress, the approximate time of copying appears on the display; keep in mind that the actual time necessary may differ.
- If the USB flash drive copy is executed, the folder name "#MEDIA" will be created in the destination folder.
- If the message "The source folder hierarchy is too deep" is displayed, copy each folder in the folder, one by one manually.
- If the "Path name is too long" message is displayed, change the hierarchy or rename the folder name to make it shorter.
- The copy operation will automatically be stopped if an unrecognizable file is detected in the folder.

How to cancel the folder copy operation

If you want to cancel the folder copy operation while the copy operation is in progress, press the [CANCEL] button.

Keep in mind, however, that cancelling the operation may take a long time, since the operation is stopped only after all files in the current folder are copied.

If you cancel the operation, make sure to check which files have been properly copied and which have not.

Instructions when only one [USB TO DEVICE] terminal is available:

It is recommended that you use connect both USB flash drives (source and destination) to the [USB TO DEVICE] terminals. However, if there are not enough terminals available, you can copy a Song by following the procedure below.

Folder copy cannot be executed with this procedure.

- 1 Follow steps 1 – 3 on page 127.
- 2 Press the  (UP) button several times until the Media List is displayed.
- 3 Select “MEMORY” as the destination.

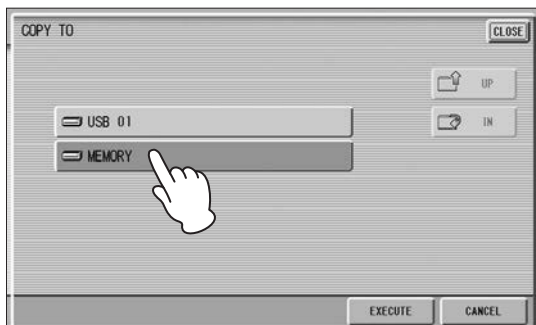

- 4 Press the [EXECUTE] button to execute the Song Copy.

The Song to be copied is copied to the internal memory of the Electone. The message “Eject the source media” will appear on the display.

NOTE

If you want to abort the operation, press the [CANCEL] button.

NOTICE

Never attempt to turn the power off during copying of a Protected Song. Data may be lost.

- 5 Eject the source USB flash drive.
After ejecting the source USB flash drive, the message “Insert the destination media” will appear on the display.
- 6 Insert the destination USB flash drive to which you want to copy.
- 7 Select the destination.
For details on specifying the destination, see page 112.

- 8 Press the [EXECUTE] button to execute Song Copy. Select [CLOSE] or [CANCEL] to abort the operation.

The Song is copied with the same name as the source Song. If you copy a Song to a folder that contains a Song whose name is the same as the source Song, the copied Song name will be “source Song name_XXX” (XXX indicates Song number). If you copy an XG-compatible Song to another folder or USB flash drive that contains a Song with the same name as the source Song, a message appears prompting confirmation of overwriting the Song. Selecting [OVERWRITE] overwrites the XG-compatible Song in the destination.

If you want to change the Song name, see page 116.

NOTE

By pressing the [CANCEL] button, you can cancel the operation which is being executed, then return the Protected Song to the original USB flash drive. For details, follow the on-screen instructions.

When moving a data-heavy Protected Song:

When the Song being moved contains a large amount of data, the move operation cannot be completed in a single pass. In such a case, repeat steps 6 to 8 by following the on-screen instructions.

Song delete

You can delete the data of one Song. You can specify for deletion only Registration data, only the performance data, or both (entire Song). Also, only the Songs created on the ELS-02/ELS-02C and XG-compatible Songs can be deleted. Songs created on the EL series instruments such as the EL-900 cannot be deleted.

- 1 Select the Song to be deleted.
For details on selecting a Song, see page 112.
- 2 Press the [TOOLS] button at the top right of the display to call up the TOOLS Page.

3 Press the [DELETE] button in the display.

A message appears, prompting confirmation of the operation.

Confirm that the Song to be deleted is shown in the display. If you want to change the Song, press the [CANCEL] button and select the desired Song.

4 Press the button of the specific data you want to delete (“DELETE ALL,” “DELETE REGIST” or “DELETE PERFORMANCE”). The selected data will be deleted.



- **DELETE ALL:** Deletes the entire Song.
- **DELETE REGIST:** Deletes only Registration data in the Song.
- **DELETE PERFORMANCE:** Deletes only performance data in the Song.

Pressing [CANCEL] aborts the operation.

When deleting folders, Songs with only registration, Songs with only performance data, Protected Songs or XG-compatible Songs:



Select [DELETE] to actually delete the data, or select [CANCEL] to abort the operation.

Converting to XG

Song data recorded on the ELS-01 series and ELS-02 series instruments can be converted to XG-compatible data which can be played back by XG-compatible devices. Before executing the conversion, confirm that the USB flash drive contains enough amount of available memory.

NOTE

- The converted XG Song data may sound differently from the original data.
- Protected Songs cannot be converted.

1 Select a Song to be converted to XG.

For details on selecting a Song, see page 112.

2 Press the [TOOLS] button at the top right of the display to call up the TOOLS Page.

3 Press the [CONVERT] button.

A “Which do you want to select?” message appears.

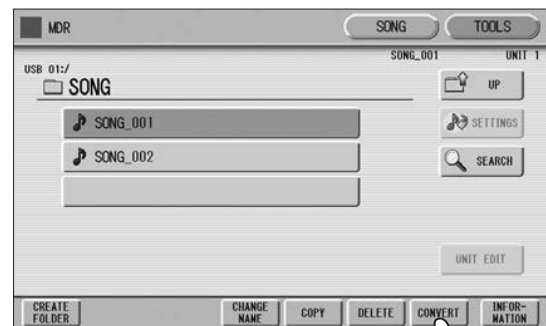

4 Press the [CONVERT TO XG] button.

The following display appears.

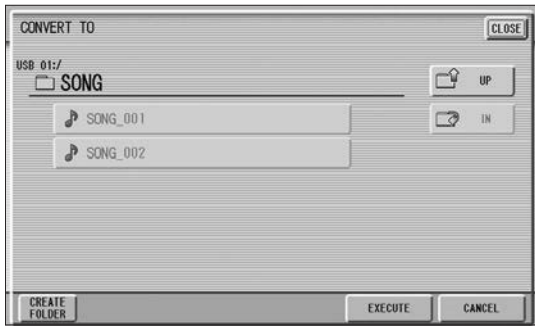

5 (If necessary) Change the destination for saving the converted Song.

For details on changing the destination, see page 112.

6 Press the [EXECUTE] button.

A message appears indicating that the converted data is being checked and the MDR starts playback of the selected Song. When playback is finished, the display returns to the previous display.

NOTE

Any playing of the keyboard or pressing of the panel controls during the confirmation of the conversion will be recorded to the converted XG-compatible Song.

Converting ELS format to EL

Song data recorded via the ELS-01 series and ELS-02 series can be converted to EL series-compatible data. The converted data in the USB flash drive can be played back by EL-series instruments to which the MDR-5 has already been installed. After creating the folders named “F01” – “F99” on the root directory in the USB flash drive, execute the instructions below.

NOTE

Protected Songs cannot be converted.

Reference page

- About Protected Songs (page 121)

1 Select the Song to be converted to EL-series format.

For details on selecting a Song, see page 112.

2 In the TOOLS Page, press the [CONVERT] button.

A “Which do you want to select?” message appears.

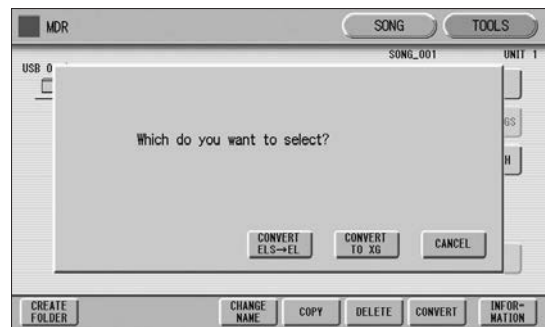
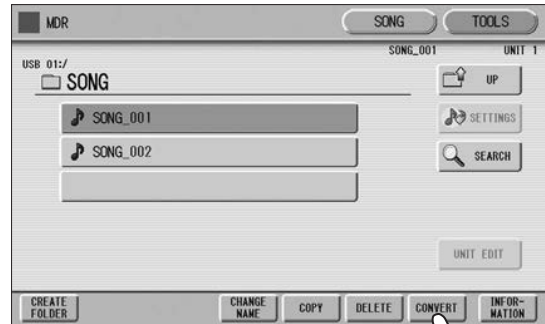

3 Press the [CONVERT ELS → EL] button.

After the dialog appears, select the destination of the converted data from F01 – F99.

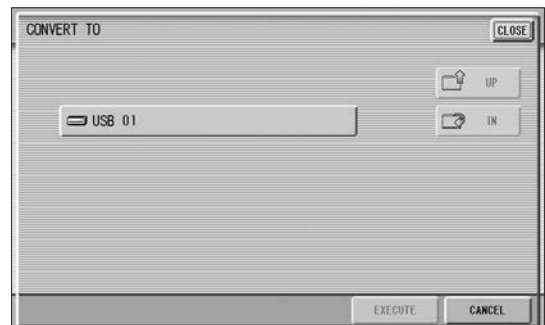

4 Press the [EXECUTE] button in the display.

Converting EL format to ELS

If Song data created on an EL-series instrument, such as the EL-900, is saved in the USB flash drive, you can convert the Song data to data compatible with the ELS series.

1 Select the Song you want to convert.

For details on selecting a Song, see page 112.

2 In the TOOLS Page, press the [CONVERT] button.

A message appears confirming if you want to convert from the EL format to the ELS format.

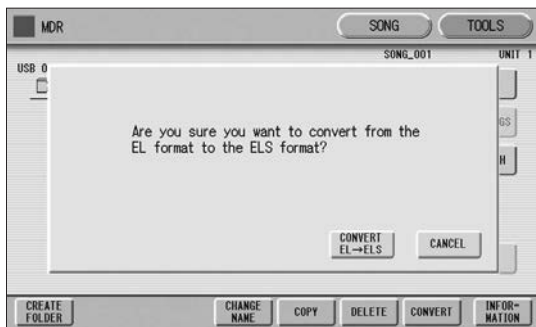

3 Press the [CONVERT EL → ELS] button in the display, then specify the destination for the converted Song.

4 Press the [EXECUTE] button in the display to start conversion.

Checking the remaining memory

When a USB flash drive is selected on the TOOLS page, pressing the [INFORMATION] button will indicate the remaining memory in the USB flash drive. When a Song is selected on the TOOLS page, pressing the [INFORMATION] button will indicate the data capacity, amount of the Bank, Song title, composer of the Song, etc. The indicated items differ depending on the Song.

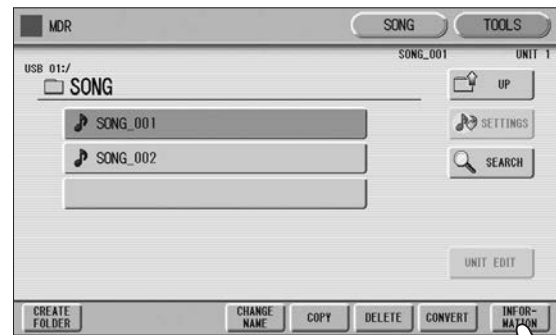

8 Audio

The convenient [AUDIO] button allows you to play back audio files (.WAV) saved to a USB flash drive. Moreover, since you can record your performances and recordings as audio data (.WAV) to a USB flash drive, it is possible to play back the files on computer, share them with your friends, and record your own CDs to enjoy as well.

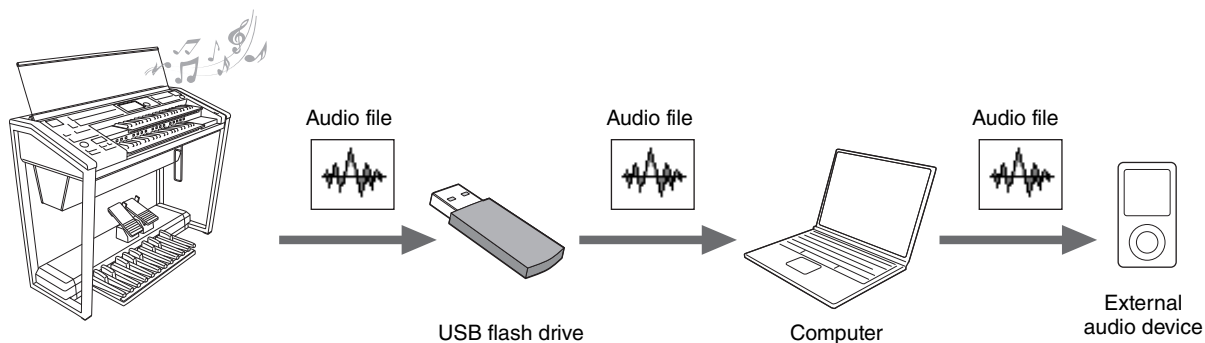

Compatible USB flash drives

Please make sure to use the compatible USB flash drives listed in the Compatible USB Device List downloadable from the Yamaha website:

<http://download.yamaha.com/>

Use of unsupported devices may result in data saving/recalling operations to abort, etc. Before using a USB flash drive, be sure to read “Connecting a USB device” on page 110.

NOTICE

To avoid the possibility of malfunction/ damage to data, follow the notices below.

- Yamaha recommends that you format a USB flash drive, after checking if the USB flash drive does not contain any important data, and to use it only for audio recording/playback. Using MDR Songs and audio data together in the same drive may cause severe fragmentation of the USB flash drive, and may stop audio recording/playback altogether.
- Insert the USB flash drive firmly and take care that the USB flash drive does not loosen from the connection from sudden shaking while performing, etc. during audio recording/playback. If the USB flash drive is disconnected while recording, it may result in data corruption in the USB flash drive.

Recording Your Performance as Audio

Audio Recording

With this method, recorded performances are saved to a USB flash drive as an audio file. An Audio file is a recording of the performed sound itself. Since it is saved in stereo WAV format of normal CD quality resolution (44.1kHz/16bit), it can be transmitted to and played on portable music players by using a computer. You can also record the monophonic sound of an external device since all the sounds produced via your vocal or guitar performance and the sound input from the [MIC./LINE IN] jack will be recorded.

NOTE

- The sound input from the [AUX IN] jack cannot be recorded.
- Keep in mind, however, that Audio recording cannot be used to save Registrations. If you want to save Registrations, perform the “Recording” operation described on page 114 in chapter 7.

Try recording your performance as an audio file to a USB flash drive. Maximum amount of recording time is 60 minutes per recording, though this may be less depending on the capacity of the particular USB flash drive.

File format that can be recorded

.wav — 44.1 kHz sample rate, 16-bit resolution, stereo

NOTE

The file extension does not appear in the Electone display. However, it can be viewed on a computer.

- 1 Connect a compatible USB flash drive to the [USB TO DEVICE] terminal.

 **Reference Page**

- Compatible USB flash drives (page 132)

- 2 Press the [AUDIO] button located at the top right on the panel to call up the AUDIO Page.

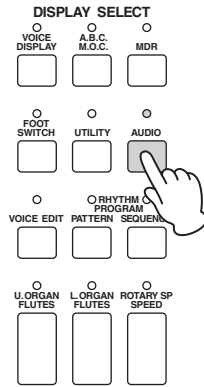

NOTE

Songs you've created on the Electone will not be shown in the AUDIO Page even when the USB flash drive contains Songs.

- 3 Select a blank audio file for recording your performance.

To call up a blank audio file, press the  (IN) button in the display of step 2 to open the USB flash drive, then select the blank audio file. Since the operation for selecting audio files is the same as that for Songs, refer to the "Selecting a Song" on page 112.

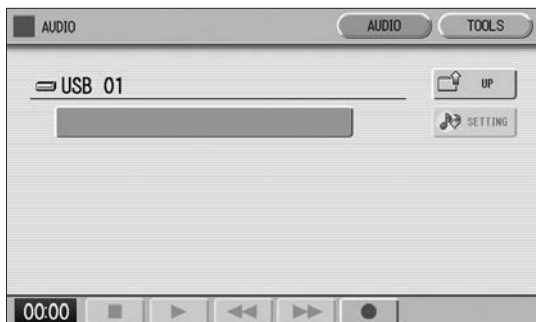

- 4 Press the [●] (Record) button to engage Standby status for recording.

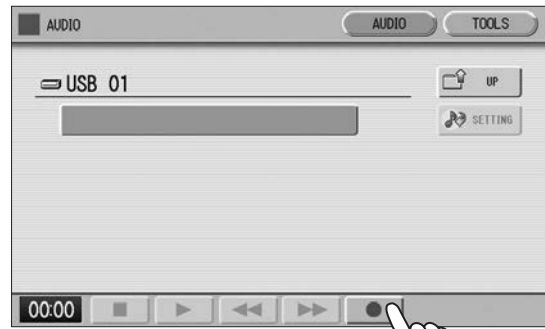

- 5 Start recording by pressing the [▶] (Play) button, and then start your performance.

When recording begins, the elapsed recording time is shown in the lower left of the AUDIO Page. Once the elapsed recording time is shown, you can load the Registration or play the Song with the MDR.



Elapsed recording time

NOTICE

Never attempt to disconnect the USB flash drive or turn the power off during recording. Doing so may corrupt the USB flash drive data or the recording data.

- 6 When you finish playing, press the [■] (Stop) button.

Recording stops and the audio file to which your performance is recorded is automatically named and selected in the AUDIO Page.

- To hear your newly recorded performance, press the [▶] (Play) button in the AUDIO Page.

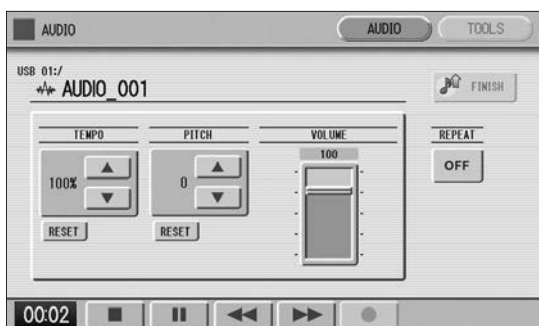
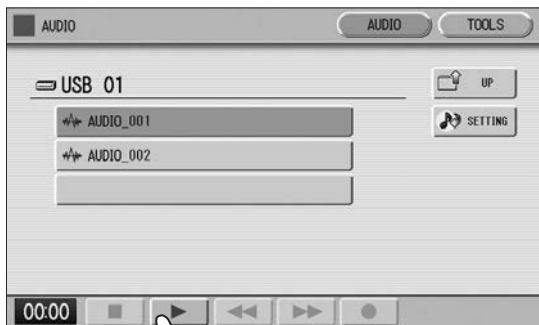

Reference Page

- Deleting the File/Changing the File Name (page 137)

Recording the Song playback as an audio file

Once you've recorded your performance as a Song using the MDR function, you can record the playback of the Song as an audio file.

- Connect two compatible USB flash drives, one containing the Song, and another for recording audio files, to the [USB TO DEVICE] terminals.
- Start audio recording (perform steps 2 – 5 above).
- Select the Song on the MDR Display, then start playback of the Song. Play back the Song to the end of the Song.
- Stop the audio recording (perform steps 6 and 7 above).

Playing Back Audio Files

Try playing back audio files from a USB flash drive connected to this instrument.

NOTE

This instrument cannot play back DRM protected files.

File format that can be played back

.wav — 44.1 kHz sample rate, 16-bit resolution, stereo

- Connect the compatible USB flash drive containing the audio file to be played back to the [USB TO DEVICE] terminal.

Reference Page

- Compatible USB flash drives (page 132)

- Press the [AUDIO] button located at the top right on the panel to call up the AUDIO Page.

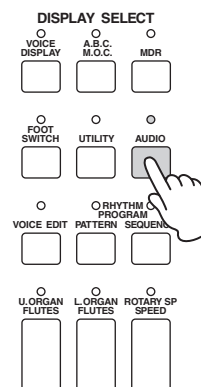

NOTE

Songs you've recorded using the MDR function on this Electone and Protected Songs will not be shown in the AUDIO Page, even when the USB flash drive contains Songs.

3 Select the desired audio file for playback.

To simply play an existing audio file, select the desired audio file (containing data), referring to the audio file name and icon . Since the operation for selecting audio files is the same as that for Songs, refer to instruction steps 2 and 3 in “Selecting a Song” on page 112.

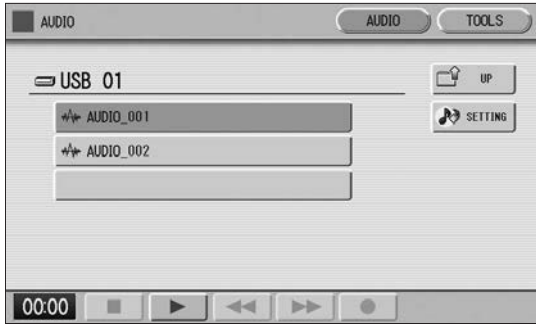

4 Press the [▶] (Play) button in the AUDIO Page to call up the Playback Page of the AUDIO Page.

When playback begins, the elapsed time is shown in the lower left of the display.

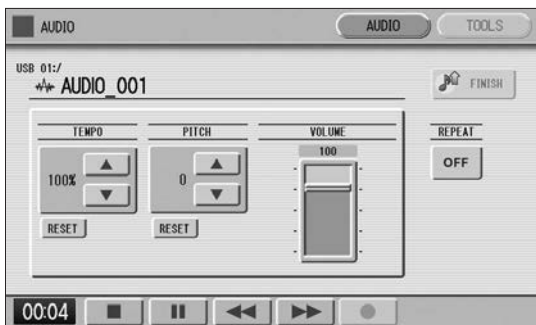
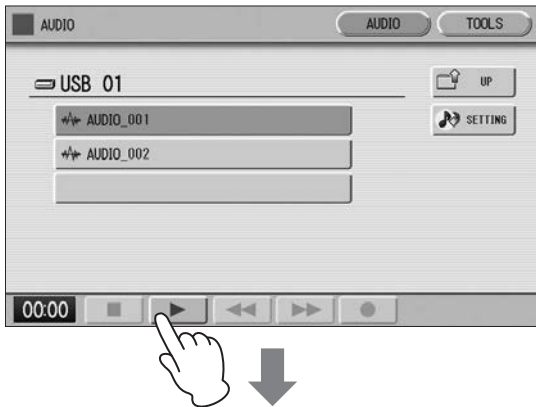

5 Press the [■] (Stop) button to stop playback.

The display returns to the AUDIO Page.

NOTICE

Never attempt to disconnect the USB flash drive or turn the power off during playback. Doing so may corrupt the USB flash drive data.

Rewind, Fast Forward and Pause

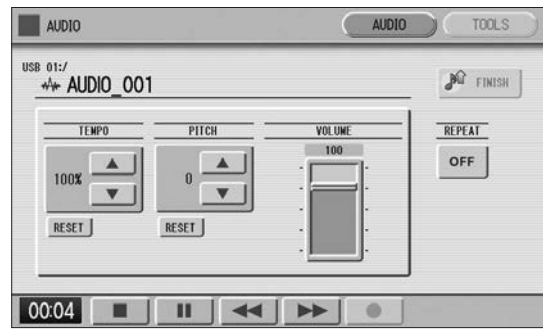

Rewind and Fast Forward:

During audio playback (or when paused), press the [◀◀] (Rewind) button or the [▶▶] (Fast forward) button and hold it down until the time reaches the desired position. When the button is released, playback is paused at the desired position. To resume playback from the point you've reversed or advanced to, press the [▶] (Play) button.

Pause:

If you want to temporarily stop playback of the audio file press the [⏸] (Pause) button. To resume playback from the point at which the audio file was paused, press the [▶] (Play) button again.

Changing the Volume, Tempo and Pitch

You can change the volume, tempo and pitch of the audio file as the file is playing.

- 1 **Connect the compatible USB flash drive to the [USB TO DEVICE] terminal.**

 **Reference Page**

- Compatible USB flash drives (page 132)

- 2 **Press the [AUDIO] button.**

- 3 **Select the desired audio file for playback.**

Since the operation for selecting audio files is the same as that for Songs, refer to instruction steps 2 and 3 in “Selecting a Song” on page 112.

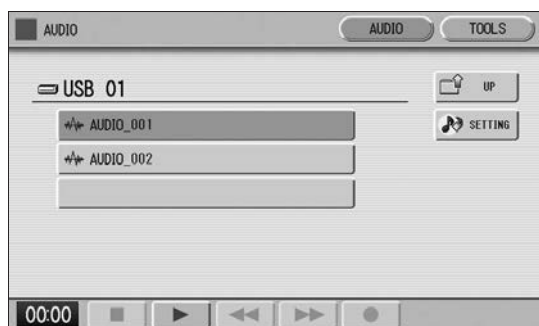

- 4 **Press the  (SETTING) button to call up the Setting display.**

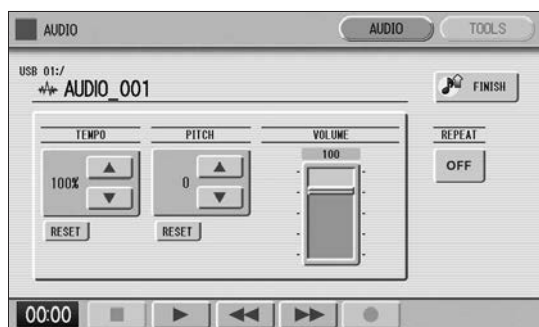
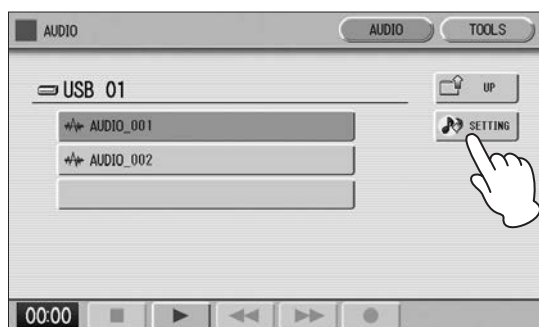



To adjust the Volume:

Touch the VOLUME slider in the display or use the Data Control dial.



Range: 0 – 127

To change the Tempo:

Use the TEMPO   buttons in the display or the Data Control dial to change the tempo. The value can be adjusted from 75% to 125% and the default value is 100%. Higher values result in a faster tempo. If you press the TEMPO [RESET] button in the display or select another audio file, this setting is restored to the default value.

Range: 75% – 125%

To change the Pitch:

Use the PITCH   buttons in the display or the Data Control dial to change the tempo. This lets you shift the pitch of an audio file in semitone steps (from -12 to 12). If you press the PITCH [RESET] button in the display or select another audio file, this setting is restored to the default value (0).

Range: -12 – +12

NOTE

- Changing the playback tempo or pitch of an audio file may change its tonal characteristics.
- Volume, tempo and pitch changes are temporary; these values revert to their defaults when the power is turned off and then back on again.

- 5 **Play back the audio file to hear and check the changes you’ve made in the Setting display.**

Repeat playback

- 1 **Press the REPEAT button as often as necessary to select the desired repeat mode.**

Each press of the button switches among the modes.

 (SINGLE)

Repeats the currently selected Song indefinitely.

 (ALL)

Repeats all Songs in the currently selected folder in order.

 (RANDOM)

Repeats all Songs in the currently selected folder randomly.

 (OFF)

Cancels repeat playback.

- 2 **Exit from the Setting display by pressing the  (FINISH) button at the top right of the display.**

- 3 **Press the [▶] (Play) button in the AUDIO Page to begin repeat playback.**

Other Functions (Tools)

Creating a New Folder/Deleting the File/Changing the File Name

You can delete the file or change the file name.

- 1 **Connect the compatible USB flash drive containing the audio files to the [USB TO DEVICE] terminal.**

Reference Page

- Compatible USB flash drives (page 132)

- 2 **Press the [AUDIO] button.**

- 3 **Select the desired audio file.**

Since the operation for selecting audio files is the same as that for Songs, refer to instruction steps 2 and 3 in “Selecting a Song” on page 112.

- 4 **Press the [TOOLS] button at the top right of the display to call up the TOOLS Page.**

In this page, you can delete or rename the audio file.

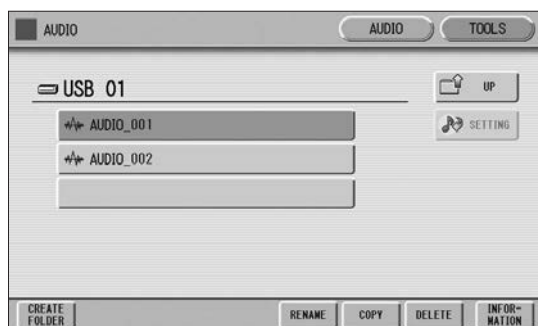
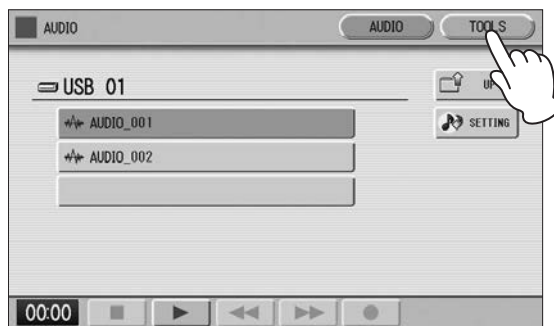

To create a new folder:

Press the [CREATE FOLDER] button in the display, then perform the same operation as in the explanation of “CREATE FOLDER” in “Using the MDR Display” on page 106 in chapter 7.

To delete the file:

Press the [DELETE] button in the display. A message appears prompting confirmation of the operation. You can cancel the operation at this point by pressing the [CANCEL] button. If you want to delete the file, press the [DELETE] button in the display. The audio file will be deleted and the display returns to the previous display.

To rename the file:

Press the [RENAME] button to call up the CHANGE NAME display. For details on how to enter characters, refer to the “Changing the Song Name” on page 116. You can cancel the operation at this point by pressing the [CANCEL] button. To finalize the name, press the [OK] button. The audio file will be renamed and the display returns to the AUDIO page.

To return to the AUDIO page from the TOOLS Page, press the [AUDIO] button in the display.

Audio file copy

To copy an audio file:

Perform the same operation as in steps 1 – 5 in “Song copy” on page 126 in chapter 7.

NOTE

- An audio file cannot be copied to the same folder that includes the source audio file.
- Since copying of an entire folder including audio files cannot be performed, copy the desired audio files one by one.
- When only one [USB TO DEVICE] terminal is available, an audio file cannot be copied between different USB flash drives.

To check the remaining memory:

When an Audio file is selected on the TOOLS page, pressing the [INFORMATION] button indicates the data capacity and playback time. When a USB flash drive is selected on the TOOLS page, pressing the [INFORMATION] button indicates the remaining memory in the USB flash drive.

To initialize (format) a USB flash drive:

Perform the same operation as in steps 3 – 5 in “Formatting a USB Flash Drive” on page 111 in chapter 7.

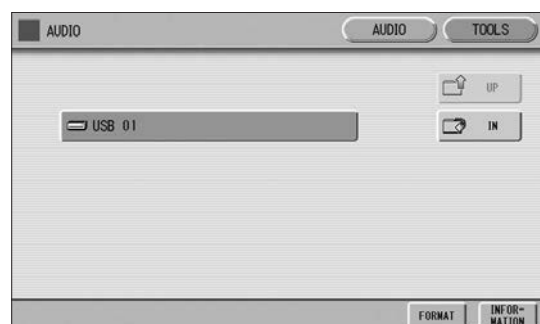

9 Voice Edit

This Electone has a Voice Edit feature that allows you to create your own Voices. We suggest that you read through the Voice Structure below at first to get a firm understanding of what comprises a Voice. Then go through the editing steps, referring to page 140 for editing of an AWM Voice, or page 143 for editing of a VA Voice.

NOTE

Super Articulation Voices cannot be edited.

Voice Structure

The internal structure of the Voices of this Electone is explained below. Refer also to “Tone Generators of the ELS-02 Series” (page 39).

AWM Voice structure

AWM Voices consist of up to eight recorded samples of a real instrument.

Each waveform, referred to as an “Element,” can be edited, by changing the level (volume), filter settings, and so on. A single Voice contains eight “boxes” (AWM1 – AWM8) in which the Elements are put. If a Voice consists of less than three Elements, some boxes are empty. For example, Strings 1 consists of two Elements (as shown).

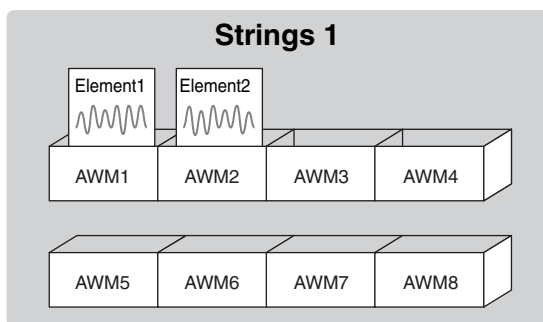

You can add Elements from other Voices – Brass, for example – if a box (AWM3 – AWM8) is empty. This allows you to create your own original ensemble sounds. In the Voice Edit function, you can edit not only each Element, but also assemble some Elements from other Voices.

VA Voice structure

VA Voices are made by simulating the characteristic behavior of acoustic instruments.

You can edit the Voice’s volume and timbre. Moreover, you can also add AWM Elements to a VA Voice to create your own original Voice.

VA Voices are available only on the Lead Voice 2 section of the ELS-02C. All Voices in the other Voice sections are AWM Voices.

Editing a Voice

Selecting a Voice for editing

1 Select the Voice you want to edit from the Voice Menu.

For example, if you want to edit Accordion 1, select [Accordion 1] in the Voice Menu of the [ORGAN] button in any Voice section.

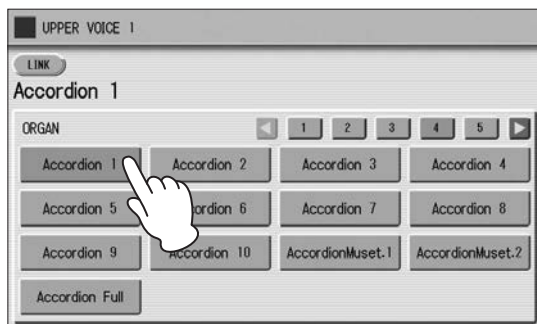
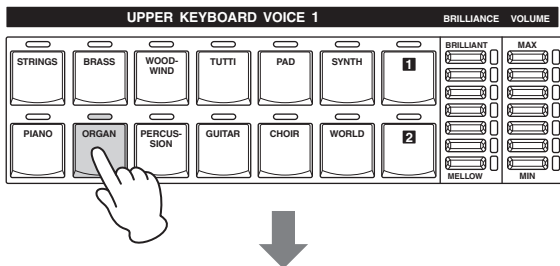

Mute all other Voice sections except for the targeted Voice section.

2 While holding down the [VOICE EDIT] button, press the Voice button corresponding to the Voice you wish to edit.

If you press [VOICE EDIT] without selecting a Voice, the following display will prompt you to complete the step. While this display appears, press the desired Voice button.

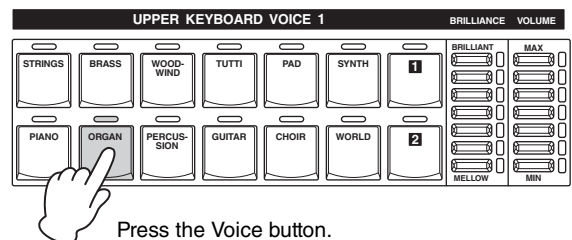
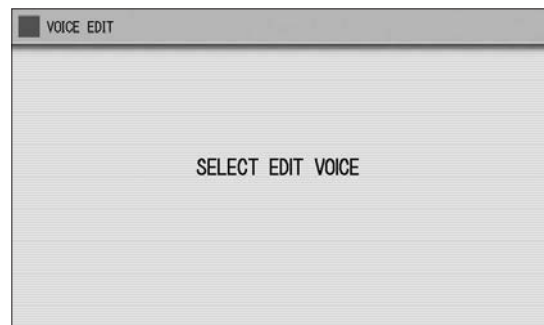
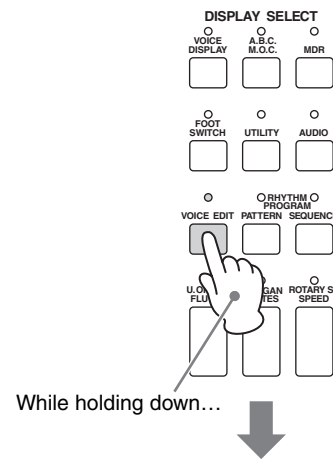

After you have selected the Voice button, the AWM Page (first page of the Voice Edit display) will appear if the selected Voice is an AWM Voice. If you have selected a VA Voice, the VA Page will appear.

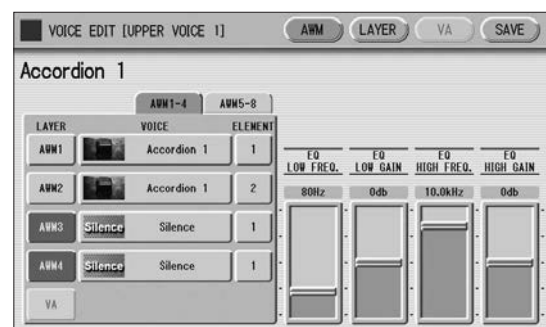

If you release the [VOICE EDIT] button before pressing a Voice button, the Voice Edit function will not be called up, and the normal Voice Display will appear.

Editing an AWM Voice

You can edit an AWM Voice on the AWM Page and LAYER Page in the Voice Edit display. In the AWM Page, the tonal balance of the entire Voice can be corrected by some EQ parameters. In the LAYER Page, you can make detailed edits to each Element.

AWM Page

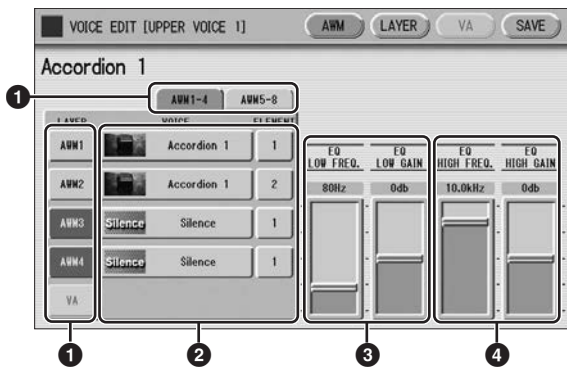

1 Element On/Off switches

The [AWM1-4] and [AWM5-8] buttons enable you to alternate the pages between AWM 1 – 4 and AWM 5 – 8. The [AWM1] – [AWM8] buttons indicate the Elements which make up the selected Voice, and the [VA] button indicates the VA tone generator (the VA button is grayed out when you are editing an AWM Voice). You can mute any of the Elements by simply pressing the corresponding button. Pressing the button again cancels the mute.

2 VOICE/ELEMENT

Indicates the Voice/Element currently being edited. In the example screen above, Element 1 of Accordion 1 is assigned to AWM1, Element 2 of Accordion 1 is assigned to AWM2, and no Voice is assigned to AWM3 and AWM4.

You can also call up another Element from another Voice and replace the currently selected Element with it. Pressing the VOICE or ELEMENT button in the display calls up the Voice or Element menu, from which you can select the desired Voice/ Element (usually Element 1). If you change the Voice, the Element will automatically change to the first Element of the Voice (usually Element 1).

3 EQ LOW FREQ./EQ LOW GAIN

Sets the frequency and gain (level) of the low frequency band. The EQ LOW FREQ. slider sets the desired frequency band over a range of 32 Hz – 2.0 kHz. The EQ LOW GAIN slider sets the level for the frequency band (specified by the EQ LOW FREQ. slider) over a range of -12 dB – +12 dB.

4 EQ HIGH FREQ./EQ HIGH GAIN

Sets the frequency and gain (level) of the high frequency band. The EQ HIGH FREQ. slider sets the desired frequency band over a range of 500 Hz – 16.0 kHz. The EQ HIGH GAIN slider sets the level for the frequency band (specified by the EQ HIGH FREQ. slider) over a range of -12 dB – +12 dB.

EQ (Equalizer)

An equalizer is usually used to correct the sound output from amps or speakers to match the special acoustic character of the room. The sound is divided into several frequency bands, then by raising or lowering the level for each band, the correction is made. This Electone has a two-band (high and low) digital equalizer that lets you adjust the overall sound according to the type of music you play — classical music being more refined and soft, pop music more crisp, and rock music more dynamic.

LAYER Page

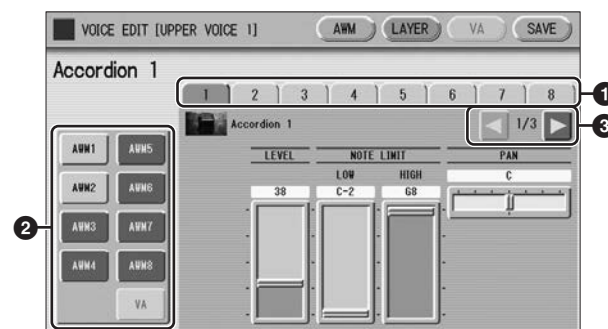

1 Element select buttons

Select the Element you wish to edit.

2 Element On/Off switches

The [AWM1] – [AWM8] buttons indicate the Elements which make up the selected Voice, and the [VA] button indicates the VA tone generator (the [VA] button is grayed out when you are editing an AWM Voice). You can mute any of the Elements by simply pressing the corresponding button. Pressing the button again cancels the mute. Muting all other Elements except for the one you are editing lets you clearly hear that single Element for ease in editing. Note that when some Elements are muted, playing the keyboard in certain key areas or with certain velocities may result in no sound.

3 Display switch buttons

The LAYER Page contains three pages. The buttons are used to switch among them.

LAYER Page 1

These buttons switch the display.

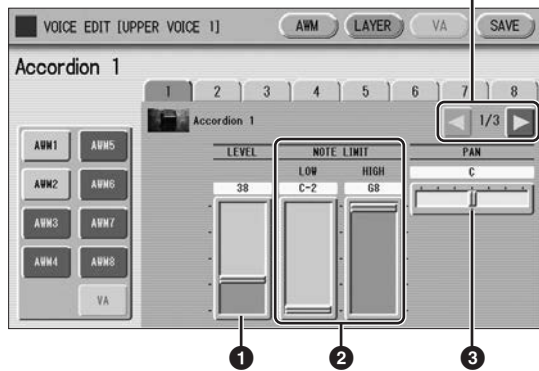

1 LEVEL

Determines the output level of the Element.

Range: 0 – 127

2 NOTE LIMIT

Determines the lowest and highest notes in the range for which the Element sounds.

The setting of the HIGH slider cannot be set lower than that of the LOW slider. Some Elements are not affected by this parameter.

Range: C-2 – G8

3 PAN

Determines the position of the Element in the stereo image.

Range: L64 – R63

LAYER Page 2

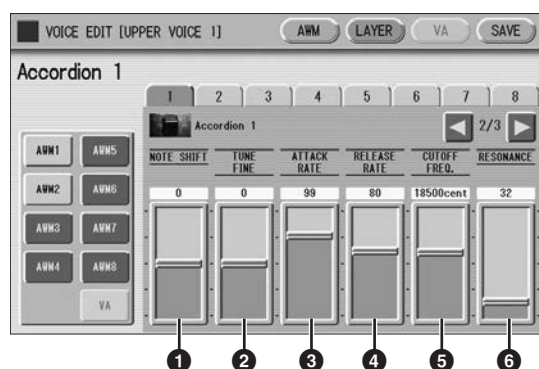

1 NOTE SHIFT

Determines the pitch settings in semitones.

Range: -64 – +63

2 TUNE FINE

Determines the fine tuning.

Range: -64 – +63

3 ATTACK RATE

Determines how quickly the Element will reach its maximum level after the key is played. Higher values produce a faster attack.

Range: 0 – 127

Reference page

- Envelope Parameters (page 143)

4 RELEASE RATE

Determines how much time it takes for the level to reach 0 after the key is released.

Higher values make the time shorter.

Range: 1 – 127

5 CUTOFF FREQ.

Determines the cutoff frequency of the filter.

Range: 9600 – 24000 cent

6 RESONANCE

Determines the amount of resonance (harmonic emphasis) applied to the signal at the cutoff frequency. Some Elements are not affected by this parameter.

Range: 16 – 140

Filter — Cutoff Frequency and Resonance

Filter modifies the tone by cutting the output of a specific frequency portion of the sound. This Electone is equipped with a low pass filter, which passes only those signals below the cutoff frequency and cuts signals above the cutoff frequency.

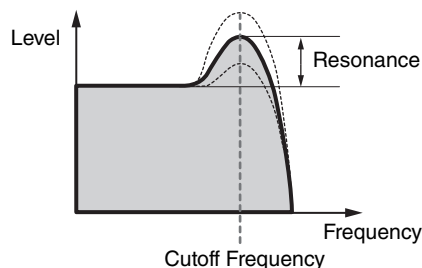
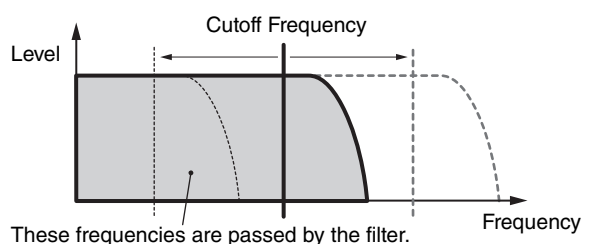

You can produce a relatively brighter or darker sound by setting the cutoff frequency.

Resonance is a parameter that boosts the level of the signal in the area of the cutoff frequency. By emphasizing the overtones in this area, this can produce a distinctive “peaky” electronic tone.

LAYER Page 3

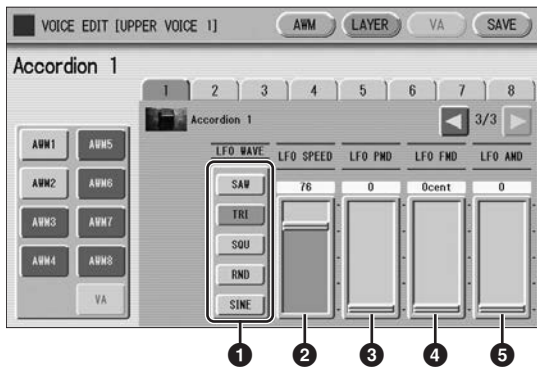

1 LFO WAVE

Determines the LFO waveform used to vary the sound. For details, see right column.

2 LFO SPEED

Determines the speed of the LFO waveform. Higher values make the speed faster.

Range: 2 – 93

3 LFO PMD (Pitch Modulation Depth)

Determines the amount by which the LFO waveform varies the pitch of the sound.

Higher values result in a greater amount of pitch change. For the minimum setting, the pitch does not change.

Range: 0 – 400

4 LFO FMD (Frequency Modulation Depth)

Determines the amount by which the LFO waveform varies the filter cutoff frequency.

Higher values result in a greater amount of frequency change. For the minimum setting, the frequency does not change.

Range: 0 – 4800 cent

5 LFO AMD (Amplitude Modulation Depth)

Determines the amount by which the LFO waveform varies the amplitude of the sound. Higher values result in a greater amount of amplitude change. For the minimum setting, the amplitude does not change.

Range: 0 – 128

When playing a User Voice you have created using the LFO parameters (above), set the Vibrato setting in the Voice Condition display to “Preset,” not “User.” If Vibrato is set to “User” and the Vibrato parameters (depth and/or speed) are set fairly high, you may not be able to hear the effect of the LFO.

Reference page

- Vibrato (page 44)

LFO (Low Frequency Oscillator)

As its name suggests, the LFO creates waveforms of a low frequency.

These waveforms can be used to vary the pitch, filter or amplitude to create effects such as vibrato, wah and tremolo.

The following five waveforms are available.

saw (sawtooth)

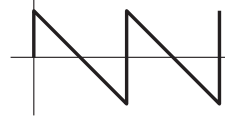

tri (triangle)



squ (square)

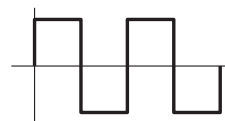

rnd (random)

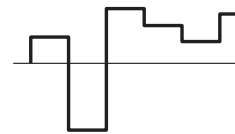

sine

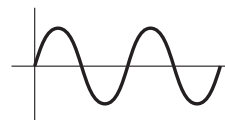

Editing a VA Voice (ELS-02C only)

You can edit a VA Voice in the VA Page of the Voice Edit display. If you are using the ELS-02, the VA Page cannot be selected.

VA Page

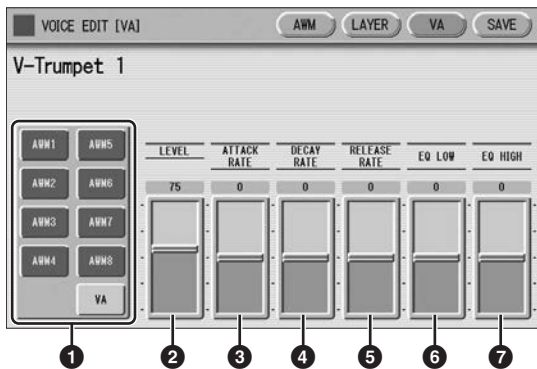

1 Element On/Off switches

The [AWM1] – [AWM8] buttons indicate the Elements which make up the selected Voice, and the [VA] button indicates the VA tone generator. You can mute any of the Elements by simply pressing the corresponding button. Pressing the button again cancels the mute. AWM buttons are grayed out when you are editing a VA Voice since VA Voices do not contain Elements. However, you can add AWM Elements to a VA sound in the AWM and LAYER Pages if you want. See page 140.

2 LEVEL

Determines the level of the VA sound.

Range: 0 – 127

3 ATTACK RATE

Determines how quickly the sound will reach its maximum level after the key is played. Lower values produce a slower attack.

Range: -64 – +63

4 DECAY RATE

Determines how much time it takes to reach its second level from the first (maximum) level.

Range: -64 – +63

5 RELEASE RATE

Determines how much time it takes for the level to reach 0 after the key is released.

Positive value makes the time shorter and negative value makes it longer.

Range: -64 – +63

6 EQ LOW

Determines the level (volume) of the low range frequencies. Positive values boost or increase the level, while negative values decrease or cut it.

Range: -64 – +63

7 EQ HIGH

Determines the level (volume) of the high range frequencies. Positive values boost or increase the level, while negative values decrease or cut it.

Range: -64 – +63

Reference page

- EQ (Equalizer); (page 140)

Envelope Parameters

The level envelope lets you control the transition in volume from the moment a note is pressed on the keyboard to the moment the sound stops. The parameters 2 – 5 above are envelope-related parameters.

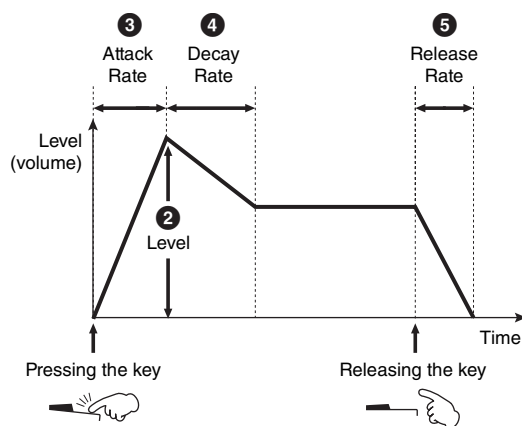

Saving the Edited Voice

Edited AWM Voices can be saved as User Voices (up to 80), and edited VA Voices can be saved as VA Custom Voices (up to six).

- 1 Press the [SAVE] button at the top right of the display to call up the SAVE Page.

When saving User Voices (AWM)

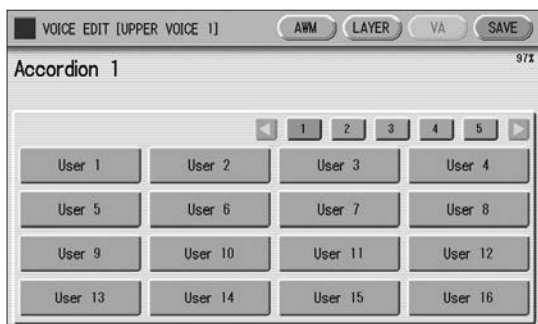

When saving VA Custom Voices (VA)

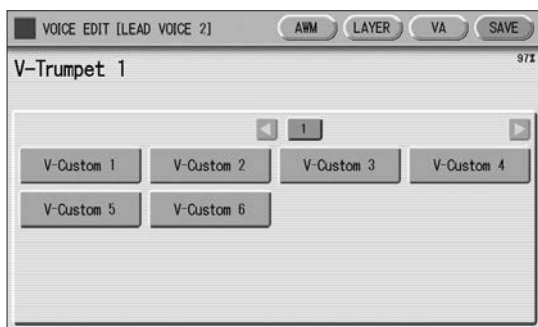

- 2 Select the User Voice number or VA Custom Voice number you wish to save to.

The message appears to prompt confirmation of the operation. (Saving a new Voice automatically erases the Voice previously stored to the selected User number.)

- 3 (If necessary) Press the [RENAME] button to give a name to your original Voice.

The method for editing the name is the same as the one for the Song name in the MDR section. (See page 116 for more information.) Up to sixteen characters can be entered.

- 4 Press the [SAVE] button to save the Voice, or press [CANCEL] to abort the operation.

NOTICE

This operation automatically erases any Voice that had been previously saved to the selected User Voice number or VA Custom Voice number. Be careful not to erase any important data. Always save your important data in advance to a USB flash drive using the MDR function.

After saving the Voice, be sure to quit the Voice Edit function (page 145) before turning the power off. Turning off the Electone without quitting Voice Edit erases the User Voice you have edited.

Quitting Voice Edit

You can quit the Voice Edit function from any of its display pages.

1 Press the [VOICE EDIT] button on the panel.

If your original Voice has already been saved, the Voice Edit function quits automatically. If the edited Voice has not been saved, a message appears prompting confirmation of the operation.

2 Select [EXIT] to quit the Voice Edit function, or [CANCEL] to abort the operation and return to the previous display.

NOTICE

When quitting Voice Edit, the square at the top left of the display turns light blue for a few seconds, indicating that the Voice you have created is currently being saved. Do not turn the power off while the Voice is being saved.

Recalling an Edited Voice

Once your original AWM Voice has been saved, it can be selected from the User button in each Voice section. Refer to chapter 2, “Selecting Voices from the User buttons” (page 28).

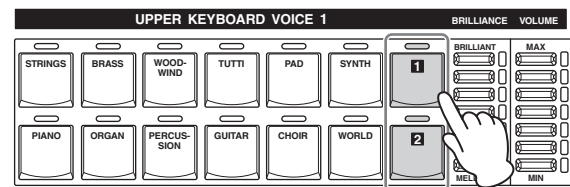

Once your original VA Voice has been saved, it can be selected from the [VA CUSTOM] button in LEAD VOICE 2. Refer to chapter 2, “Selecting Voices with the Voice buttons” (page 25).

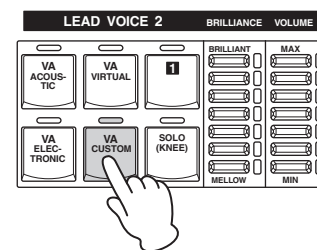

10 Rhythm Program

The Electone includes powerful rhythm programming functions: Rhythm Pattern Program and Rhythm Sequence Program. Rhythm Pattern Program allows you to record your own original rhythms and save them as user rhythms. Rhythm Sequence Program lets you connect the existing rhythms or your original rhythms to create complete rhythm tracks, which you can automatically play back during your performance. Moreover, Rhythm Sequence Program includes an automatic Registration Shift feature — called Registration Sequence.

Outline of the Rhythm Programming Operation

Rhythm Pattern Program (pages 146 to 162)

You can create your original rhythm patterns by entering percussion sounds or editing preset rhythm patterns.

Entering percussion sounds and/or editing them



Creating/editing the accompaniment backing patterns played via the Lower Keyboard



Making effect settings and detailed settings for each percussion Voice (Pan, Tune, and so on)



Saving your rhythm patterns as User rhythms



Rhythm Sequence Program (pages 172 to 176)

You can connect any of the rhythms together to make complete rhythm compositions. Moreover, you can also program Registration Shift events at any point in the composition so that the Registration Memory settings automatically change as the Rhythm Sequence plays back.

Selecting the destination of the sequence



Entering a rhythm pattern one by one



Programming the Registration Sequence

Rhythm Pattern Program

Rhythm Pattern Program lets you use any of the different instrument sounds (drum and percussion) assigned to each key on the Upper and Lower keyboards in creating your own rhythms. Up to 48 of your original rhythms can be saved as User Rhythms.

Entering the Rhythm Pattern Program

There are two ways to program a User pattern: copying a preset rhythm that is similar to the rhythm you want to create, or creating your own rhythm from scratch.

To copy a preset rhythm:

Copying a preset rhythm lets you make changes to an existing rhythm, saving you time if you want to program a rhythm that is similar to an existing preset pattern.

- 1 Select the rhythm you want to copy from the Rhythm Menu.
- 2 While holding down the [PATTERN] button in the panel (the display prompts you to select a rhythm), select the Rhythm button that contains the preset rhythm to be copied to the Rhythm Pattern Program.

NOTE

- Pressing the [PATTERN] button while the rhythm is running automatically stops the rhythm.
- Rhythms with names ending with "+" cannot be edited and used with the Assemble function (page 149).

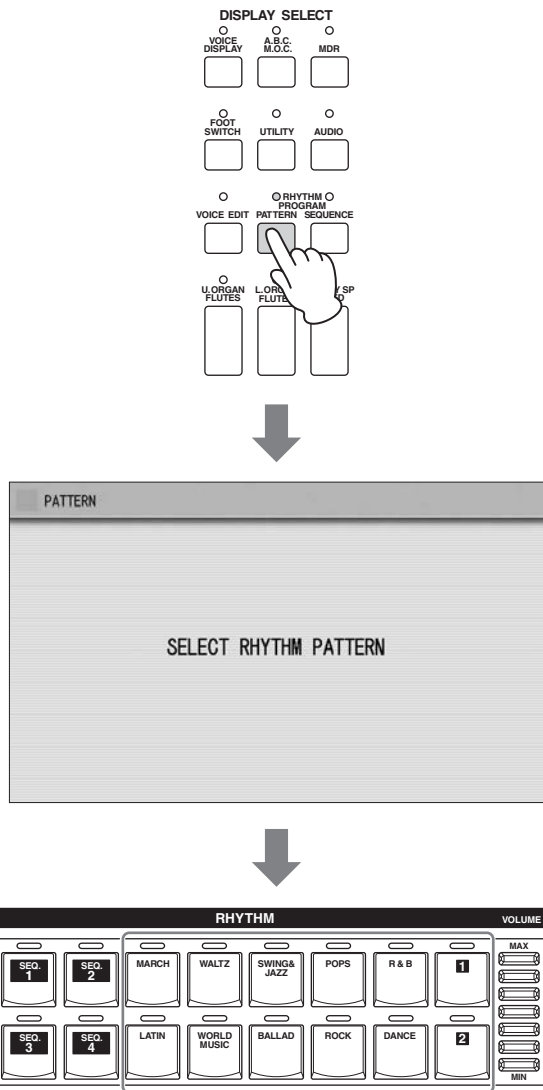

Deleting unnecessary Sections

When you create a Rhythm pattern based on Preset Rhythm data or already created User Rhythm data, created data will be stored together with the unedited other Sections. Even if you edit only Main A and Main B, all other Sections will also be stored as User Rhythm data. Because of this, the remaining memory capacity (page 162) may decrease faster than expected. To save on memory capacity, you should delete unnecessary Sections which may not be used for your performance by pressing the [ALL] button on the CLEAR PART window (page 150).

To create your own rhythm from scratch:

Press the [PATTERN] button and release it without selecting a Rhythm button.

A blank pattern is loaded to the Rhythm Pattern Program.

A Rhythm consists of 15 sections: Intro 1 – 3, Main A – D, Fill In A – D, Ending 1 – 3, and Break.

In Rhythm Pattern Program, you can enter or edit percussion notes one by one, or assemble each part from other different rhythms to create your own new User Rhythm.

Case 1: Creating your own rhythm by changing a preset rhythm

Preset Rhythm

Intro 1	Main A	Fill In A
2	B	B
3	C	C
	D	D
Ending 1	Break	
2		
3		

Changing Intro 1 to Intro 1'

Save as a User Rhythm

User Rhythm

Intro 1'	Main A	Fill In A
2	B	B
3	C	C
	D	D
Ending 1	Break	
2		
3		

All Rhythm sections, including any which have not been edited, are saved as one User Rhythm.

Case 2: Creating your own rhythm by assembling parts from other different rhythms

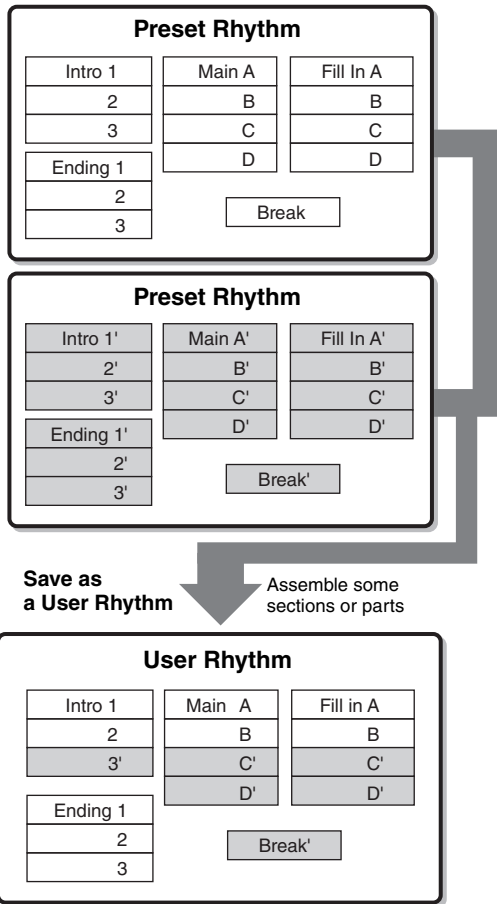

Case 3: Creating your own rhythm from scratch

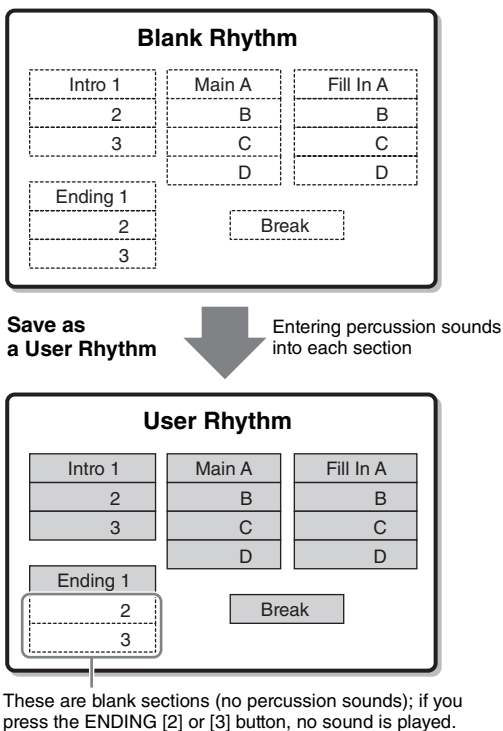

Basic settings for the rhythm pattern

In the SETTING Page of the display, set the conditions of the rhythm, such as time signature, measure length, and so on. You can also customize the part settings in this SETTING Page — deleting any part or copying a part from another rhythm to the currently selected rhythm.

- 1 Press the [SETTING] button in the display to call up the SETTING Page.

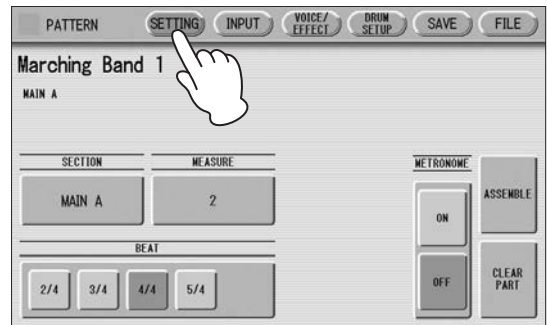

- 2 Determines the time signature used for the rhythm.

You can select the time signature with the BEAT buttons.

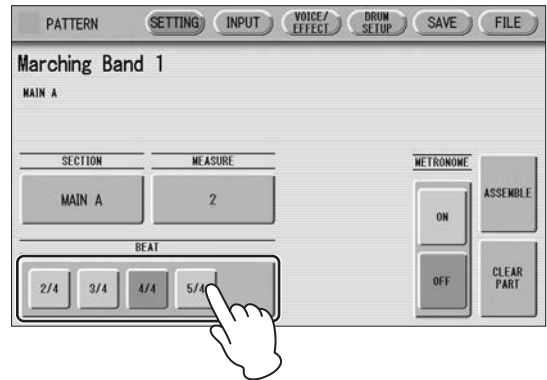

If you start the Rhythm Pattern Program from a preset rhythm, pressing a BEAT button that is not the same as the currently selected rhythm calls up the following message.



Selecting [CLEAR] deletes all data in the rhythm and changes the time signature. Select [CANCEL] to abort the operation.

3 Select a section to which you want to enter or edit the rhythm pattern.

Pressing the SECTION button on the display calls up the Section Select pop-up menu. After selecting the desired section, the pop-up menu automatically closes.

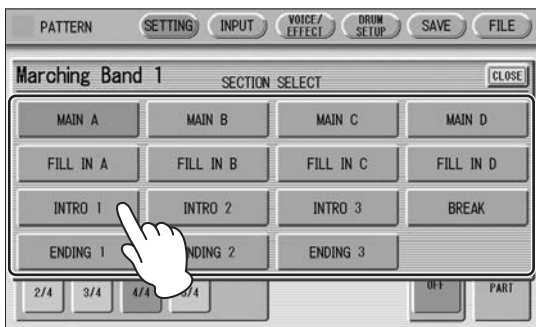
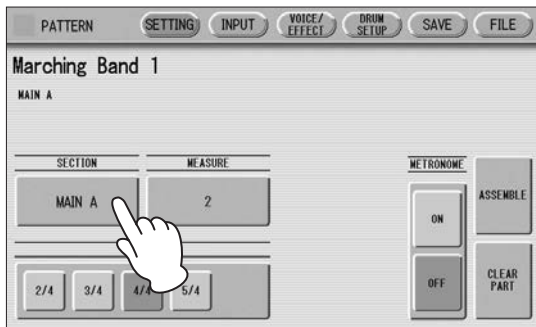

You can play the selected section by pressing the Rhythm [START] button on the panel. You can also change the section while the rhythm is playing. For details on muting the accompaniment part, refer to page 158.

4 Sets the measure length of the rhythm pattern.

Pressing the MEASURE button on the display calls up the Measure Select pop-up menu. Select the desired number of measures in the pop-up menu. If you select Break or Fill In as the section, the measure value cannot be changed.

5 (If necessary) Set the Metronome, Part Assemble, and Part Clear parameters.

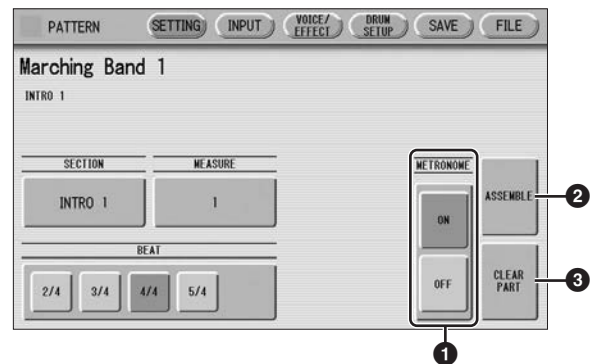

1 METRONOME

Turns the metronome click on or off. When set to ON, the metronome sounds on each beat of the measure (for example, three times per measure in 3/4 time) to serve as a rhythmic guide when programming patterns. Set to On here with Real Time Write.

Reference pages

- Step Write and Real Time Write (page 150)
- Entering percussion sounds to a rhythm pattern — Real Time Write (page 151)

NOTE

Pressing the VOLUME buttons for Rhythm also changes the volume of the metronome.

2 ASSEMBLE

Copies parts from another rhythm to the currently selected rhythm. You can assemble various sections from multiple rhythms to create your original rhythm. Pressing the [ASSEMBLE] button calls up the following display.

Select copy source (Rhythm, Section, and Part)

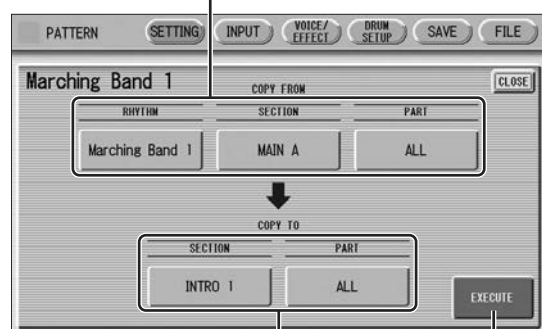

Select the part for the copy destination

Press here to execute the copy

Select the copy source: Rhythm, Section and Part. Then select the destination. You can copy only one selected part, or all parts of a rhythm.

After setting the source and destination, press [EXECUTE]. Copy is executed and returning to the previous display.

You can also select a rhythm pattern currently being created as the COPY FROM RHYTHM.
To create a MAIN B section based on MAIN A, create the MAIN A rhythm in the INPUT page, copy it to MAIN B, then edit the MAIN B rhythm as desired.

To select the rhythm currently being created, select "Current Rhythm" on the 5th page of the "USER" category.



3 CLEAR PART

Clears a specific part or parts from the currently selected rhythm. Pressing this button calls up the following display.



Select the part you want to delete from the displayed parts. You cannot select a part that contains no data (the button is grayed out). If you select [ALL] here, the percussion and all accompaniment parts are cleared.

Reference page

- Accompaniment (page 65)

When selecting the desired part, a display prompting confirmation of the operation appears. Select [CLEAR] to execute the operation, or select [CANCEL] to abort the operation.

NOTE

If you select BASS here, the bass phrase in the A.B.C. will be cleared.

Deleting the current Section

Pressing the [ALL] button on the CLEAR PART window will delete all data of the current Section. To conserve remaining memory capacity (page 162), delete unnecessary Sections which may not be used for your performance.

Step Write and Real Time Write

There are two different methods you can use to program rhythms: Step Write and Real Time Write.

Step Write allows you to enter percussion sounds as individual note values. As a method, it is very similar to writing down the notes on a sheet of music paper; each note is entered one at a time, and though you can hear each individual note entered, you cannot actually hear the pattern playing as you create it. Step Write is good for precision and for entering percussion sounds whose note placement and rhythmic value has been determined, such as a bass drum that plays every beat in a measure.

Real Time Write on the other hand, is similar to using a multi-track tape recorder; you can hear previously recorded parts of the pattern as you record new parts on top. Real Time Write is best for capturing the "feel" of a rhythm, because it allows you to actually play the pattern as you are creating it.

Each method has its own advantages and uses. Which method you use depends partly on the type of rhythm you intend to create and partly on your own personal preference.

You can switch between the two methods in editing to create a single rhythm by the use of both methods. This would come handy, for example, in programming the basic beats of a rhythm with Step Write, then using Real Time Write to add percussion accents and embellishments.

Which mode of the operation is selected depends on the play status of the rhythm. If the rhythm is stopped, Step Write is automatically selected. If the rhythm is playing, Real Time Write is selected. See the instructions page 151 for Step Write, and page 155 for Real Time Write.

Entering percussion sounds to a rhythm pattern — Step Write

You can enter percussion sounds in the INPUT Page of the display. Before entering percussion sounds, turn off the Upper and Lower keyboard Voices by setting each Voice's volume to MIN.

NOTE

The volume of the percussion and accompaniment sound during use of Rhythm Pattern Program can be controlled with the VOLUME button of the RHYTHM section. When you quit Rhythm Pattern Program, the VOLUME of the RHYTHM section will return to the previous selected level.

- 1 Press the [INPUT] button at the top of the display to call up the INPUT Page.
- 2 Select the part, MAIN DRUM or ADD DRUM, to which you want to enter the percussion.

In general, main (or basic) drum/percussion instruments (such as Bass Drum, Snare Drum, and so on) are entered in Main Drum part and others (such as Tambourine, Triangle) are entered in Add Drum part.



- 3 Select the desired Drum Kit.

You can select a kit from the two categories, Drum Kit and SFX Kit. For details on each kit, see page 164. Pressing the desired kit in the Kit list will close the list, and then call up the selected kit to the Upper and Lower keyboards.



Drum kit SFX kit

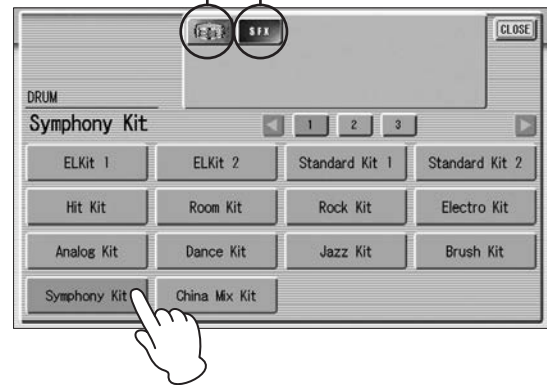

You can select only one kit for each part (Main Drum or Add Drum). When you want to create a rhythm pattern including two different drum kits, select one kit for Main Drum and another for Add Drum.

- 4 Select the percussion sound you wish to enter by pressing the key on the Upper or Lower keyboard that corresponds to the sound.

The selected instrument's name appears on the display.



5 Set the appropriate Quantize value.

For details on Quantize, refer to page 155.

NOTE

The Quantize setting can be changed in the middle of Step Write.



6 Set the Gate Time. (This is optional, and only necessary when you want to enter a sustaining sound, such as a whistle.)

For a list of instruments that require a Gate Time setting, refer to the Percussion Kit List on page 164. For details on Gate Time, refer to page 158.

7 Use the ACCENT buttons to enter the sound to the selected point. Press each ACCENT button to actually enter the percussion sounds.

You can change the rhythm clock to which the percussion sound is entered by pressing the QUANTIZE [◀] [▶] buttons.

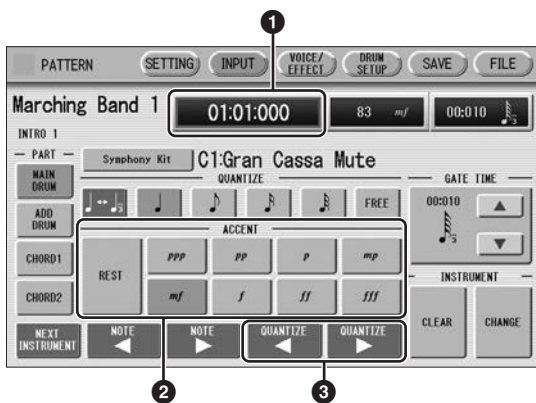

1 Rhythm Clock box

Displays the current position in the pattern according to measure, beat, and number of clicks.

A click is the smallest division of a pattern, and one beat is made up of 480 clicks.

The rhythm clock advances up to the measures set in the SETTING Page and loops back to the beginning of the rhythm (01:01:00).

🔗 Reference page

- Basic settings for the rhythm pattern (page 148)

2 ACCENT buttons

Records the instrument and determines its volume or Accent level. Press one of the ACCENT buttons you wish to set (“*ppp*” is softer and “*fff*” is louder; “REST” is no sound). The instrument is automatically inserted at the Accent level to the selected position in the pattern.

Selection of an Accent level automatically advances the rhythm clock by one step, according to the current Quantize resolution value.

3 QUANTIZE [◀] [▶] controls

Each press of the buttons advances or reverses the rhythm clock by one step. The size of a single step is determined by the Quantize value.

8 Repeat steps 4 through 7 above to layer each instrument and complete your own rhythm.

Editing entered percussion notes

You can change the accent level, position, or gate time of the entered sound, or delete the entered sound.

To change the accent level of an entered note:

1 Select the desired note for changing the accent level.

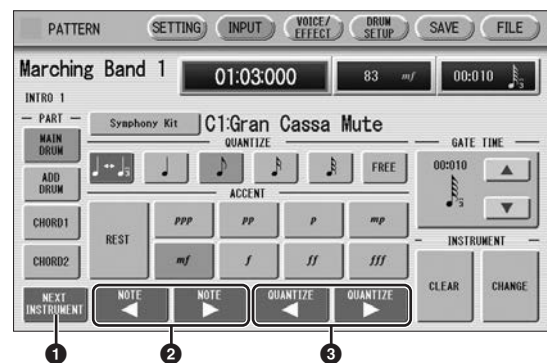

1 NEXT INSTRUMENT

Selects the entered instruments one by one, from left key to right.

2 NOTE [◀] [▶] controls

Selects the previous/next position's note of the currently selected instrument. In the notes below for example, you can select notes ①, ③ and ④ one by one. Rests (② and ⑤) are ignored.



3 QUANTIZE [◀] [▶] controls

Advances or reverses the rhythm clock by one step. The size of a single step is determined by the Quantize value.

2 Change the accent level by using the ACCENT buttons or Accent field.

The Accent field allows for finer changes.

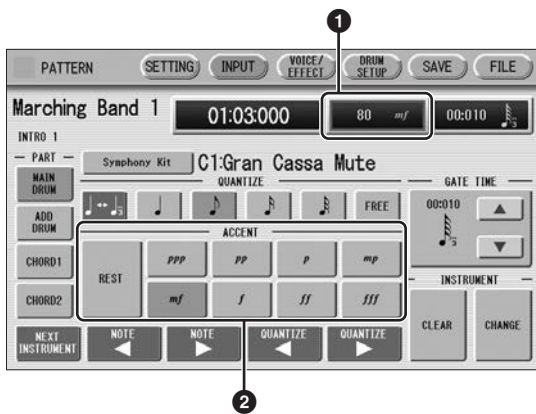

1 Accent field

Touch on the box to enable the Accent field. Turning the Data Control dial changes the accent level over a range of 0 – 127. The minimum setting results in no sound.

2 ACCENT buttons

Determines the coarse accent level. Eight accent levels (from “*ppp*” to “*fff*”) are available. Press the desired Accent button to change the currently selected note to the selected level.

To move an entered note:

- 1 Select the note you want to move (as in step 1 on page 152).
- 2 Press the Rhythm Clock box to enable the box.
- 3 Turn the Data Control dial to change the position by one clock.



To change the length of an entered note:

The length of sustaining sounds such as Snare Roll and Whistle can be changed by adjusting the Gate Time. See page 158 for more information.

To erase an entered note:

- 1 Select the note you want to erase (as in step 1 on page 152).
 - 2 Press the [REST] button in the ACCENT section of the display.
- The selected note is deleted and replaced with a rest.



You can also erase all notes of a single instrument, or all notes entered.

To erase one instrument:

- 1 **Select the key to which the instrument that you want to erase is assigned.**
The key name you have selected and its instrument name are displayed.



- 2 **Press [CLEAR] in the display.**
The following display appears, prompting confirmation of the operation.



- 3 **Select [CLEAR] to erase the selected instrument.**
A bell sound indicates that the instrument has been erased.

The following method can also be used to erase one instrument.

- 1 **While holding down the [CLEAR] button, press the key on the keyboard corresponding to the instrument you wish to erase.**
A bell sound indicates that the instrument has been erased.

To erase all instruments:

- 1 **Press [CLEAR] in the display.**
The following display appears, prompting confirmation of the operation.



- 2 **Select [CLEAR ALL] to erase all instruments.**
All instruments are instantly erased.

When you want to replace the instrument you have already entered with another instrument, it's not necessary to delete and re-enter. You can quickly replace the sound with the following procedure.

To replace the instrument:

Before the operation, stop the rhythm.

- 1 **Select the key to which the instrument you want to replace is assigned.**
The key name you have selected and its instrument name are displayed.

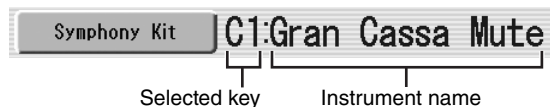

- 2 **Simultaneously hold down the [CHANGE] button in the display and press the key on the Upper or Lower keyboard that corresponds to the instrument you want to use.**
The instrument is instantly erased and replaced with the newly selected one.

About Quantize

The Quantize function is a process of rounding off timing or duration values, so that each note plays with precise timing. You can select nine types of Quantize value.

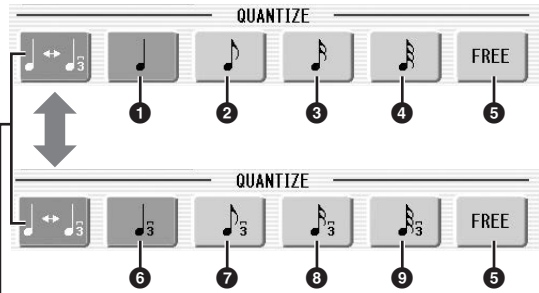

With this button, change the displayed Quantize buttons

With Step Write

This allows you to automatically correct the length (duration) and timing of each note you enter.

Steps Depending on the Quantize Values

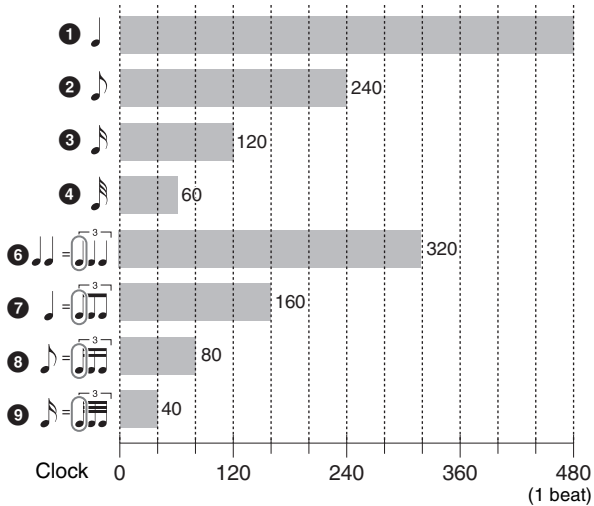

Setting Quantize to FREE (9) results in the finest, least amount of quantization (1/480 beat).

With Real Time Write

This allows you to automatically correct the timing of the notes you play, according to the specified Quantize resolution. No correction occurs when you select FREE. Generally, you should set Quantize to be the same as the shortest note you intend to play.

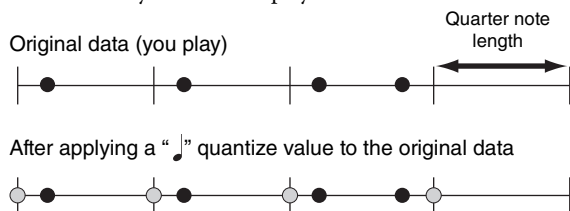

Entering percussion sounds to a rhythm pattern — Real Time Write

While you listen to the entered rhythm or metronome click, play the Upper/Lower keyboards to enter the desired percussion sounds.

1 Select the desired part to which the percussion sounds are entered, and the desired drum kit, by following steps 1 – 3 on page 151.

2 Set the appropriate Quantize value.

The positions at which the sounds are input will be corrected according to the predetermined Quantize value in the Real Time Write operation.



3 Press the rhythm [START] button in the panel.

The rhythm (or Metronome) starts playing, enabling the Real Time Write operation.



4 The rhythm (or Metronome) starts playing, enabling the Real Time Write operation.

If you have started the Rhythm Pattern Program by copying a preset rhythm, you can listen to the selected rhythm as you play the sound. If you have started from scratch, set the Metronome to “on” in the SETTING Page and listen to the metronome click. The pattern will automatically repeat (or

10 Rhythm Program

“loop”) for a certain number of measures as set in the SETTING Page.

 **Reference page**
 • Metronome (page 149)

5 Repeat steps 2 through 4 above to layer each instrument and complete your own rhythm.

You can erase an instrument while the rhythm is playing back.

To erase an instrument/key assignment:

While holding down the [CLEAR] button, press the key on the keyboard corresponding to the instrument you wish to erase. All instances of the selected instrument will be erased from the pattern.

When you want to erase all instruments, or edit entered percussion notes, you need to stop the rhythm before editing. See page 152, “Editing entered percussion notes.”

Creating backing patterns (Rhythmic Chord function)

The Rhythm Pattern Program allows you to use one of the Electone’s Accompaniment patterns with your original rhythm. You can select and save the Accompaniment pattern that best matches the rhythm that you have created. Moreover, Rhythm Pattern Program features a Rhythmic Chord function that lets you add your own backing patterns to the rhythms you create.

To select an appropriate Accompaniment pattern for your newly created rhythm:

- 1 Press the [SETTING] button at the top of the display to call up the SETTING Page.**
- 2 Press the [ASSEMBLE] button.**
 A pop-up menu appears, letting you select the copy source and destination parts.

3 Using the COPY FROM [RHYTHM] and [SECTION] buttons, select the rhythm and the section which has the accompaniment you wish to use.

 **Reference page**
 • Basic settings for the rhythm pattern (page 148)

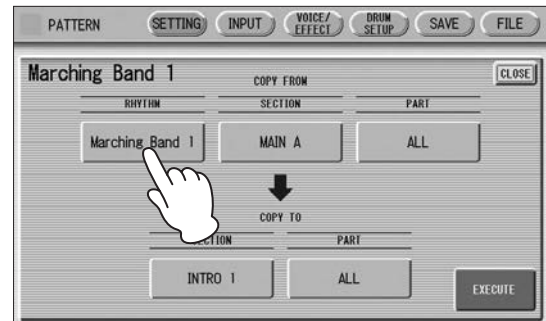

4 Using the COPY FROM [PART] button, select the accompaniment part you want to copy.

5 Using the COPY TO [PART] button, select the desired accompaniment part (CHORD 1 or CHORD 2) to be used for the Rhythmic Chord pattern.

6 Press the [EXECUTE] button to execute the copy.

The desired accompaniment part (Rhythmic Chord pattern) has been copied.

To create your own backing patterns with the Rhythmic Chord function:

The Rhythmic Chord pattern can be entered by the same methods as the rhythm: Step Write and/or Real Time Write.

1 Press the [INPUT] button at the top of the display to call up the INPUT Page.

- 2 Select the part, CHORD 1 or CHORD 2, which you want to create for the Rhythmic Chord pattern.**



If the part you have selected contains a preset accompaniment pattern, a message appears prompting you to confirm whether you want to clear the existing data or not. To create your own Rhythmic Chord pattern, select [CLEAR].

- 3 Select the desired Voice.**

Pressing the button showing the Voice name calls up the relevant Voice Menu.

Select the desired Voice category with the instrument icon buttons, then select the desired Voice from the Voice Menu. The selected Voice is called up for both the Upper and Lower keyboards.

NOTE

The Voice menu that appears here is not the same as the one for the Voice Sections.



Voices can also be changed even after entering the Rhythmic Chord pattern.

You can select only one Voice for one part (Chord 1 or Chord 2). When you want to create a Rhythmic Chord pattern including two different Voices, select one Voice for Chord 1 and another for Chord 2.

- 4 Set the appropriate Quantize value.**

For details on the Quantize function, refer to page 155.

- 5 Set the Gate Time.**

You can adjust the Gate Time setting by using the GATE TIME buttons in the display, or the Data Control dial. Using the buttons in the display makes coarse changes in the value. Using the Data Control dial makes fine changes.



Gate time determines the actual length of time a note sounds. For example, a quarter note is sometimes played as tenuto (long length) and sometimes played as staccato (short length).

Since 1 beat is made up of 480 clocks, a quarter note played tenuto may have a gate time between 450 – 470, and a staccato quarter note may be about 240.

- 6 Enter the Rhythmic Chord pattern.**

The methods for entering the Rhythmic Chord pattern are the same as those for entering the rhythm pattern. Any key you press sounds a C major triad chord (C, E, and G). For information on Step Write, see page 152; for information on Real Time Write, see page 155.

You can also edit the entered Rhythmic Chord pattern using the same method as in “Editing entered percussion notes” (page 152). To change the gate time of the notes of the Rhythmic Chord pattern, follow the instructions (see page 158).

To change the Gate Time:

- 1 Select the note for which you want to change the gate time (see step 1 on page 152).
- 2 Press the Gate Time box to enable the box.
- 3 Turn the Data Control dial to change the Gate Time.



Changing the Voices for Accompaniment parts

In Rhythm Pattern Program, you can create your original drum patterns using Main Drum and Add Drum, and original backing patterns using Chord 1 and Chord 2. Moreover, you can change the Voices for all accompaniment parts, including Pad, Phrase 1 and Phrase 2. Voices can be changed in the VOICE/EFFECT Page.

- 1 Press the [VOICE/EFFECT] button at the top of the display to call up the VOICE/EFFECT Page.
- 2 Press the [VOICE] button in the display. The following display will appear.

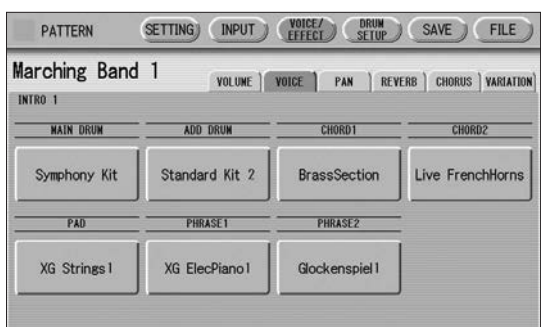

- 3 Select the desired part for which you wish to change the Voice. The Voice menu appears.

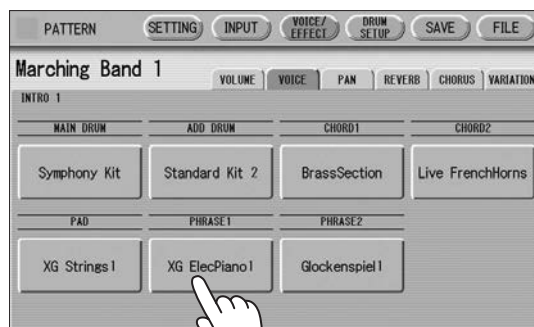

- 4 Select the desired Voice, and the Voice menu automatically closes.

NOTE
The Voice menu that appears here is not the same as the one for the Voice Sections.

After selecting the desired Voice, customize the accompaniment to your personal preference by adjusting the volume and pan, and setting the desired effects (see page 159).

Adjusting volume and panning

Volume and Pan are set in the VOICE/EFFECT Page.

VOLUME display

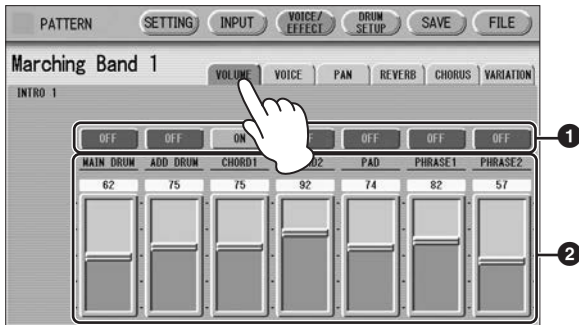

1 ON/OFF

Determines the on/off status of each accompaniment part. When this is set to OFF, the part is muted.

2 Volume sliders

Determines the volume of each accompaniment part.
Range: 0 – 127

PAN display

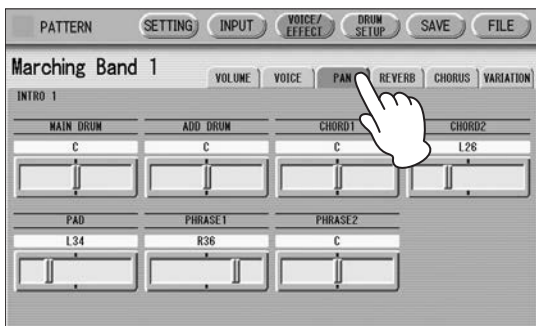

Determines the position of each accompaniment part in the stereo image.

Range: L64 – R63

Effect settings

You can set Reverb, Chorus, and Variation effects as desired for your original rhythm.

Reverb adds a warm ambience to the sound, simulating the complex reflections of actual performance spaces, such as a concert hall or a small club. Chorus provides a wide variety of sound transformations and enhancements. Variation includes many kinds of special effects for changing the sound, both subtly and radically. These effects are set in the VOICE/EFFECT Page.

REVERB display

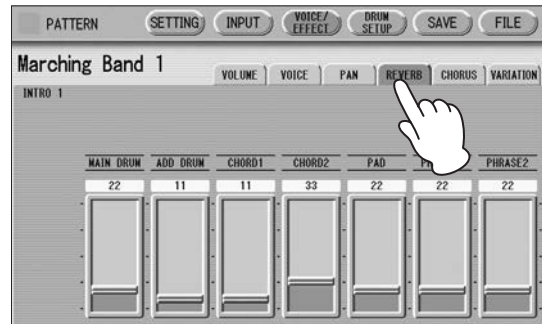

Determines the amount of reverb applied to each accompaniment part.

Range: 0 – 127

CHORUS display

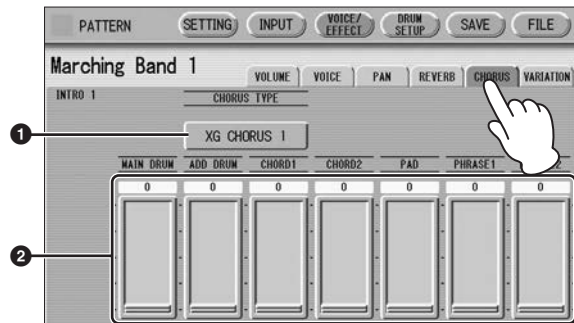

1 CHORUS TYPE

Determines the type of the chorus effect. Pressing the CHORUS TYPE button calls up the chorus type list.

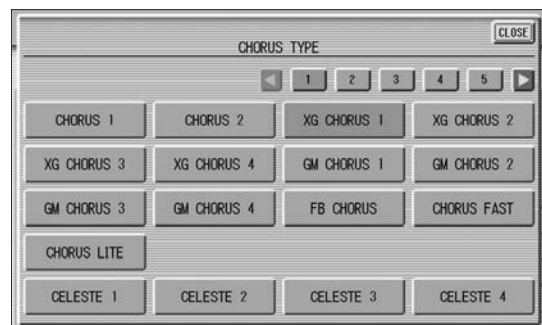
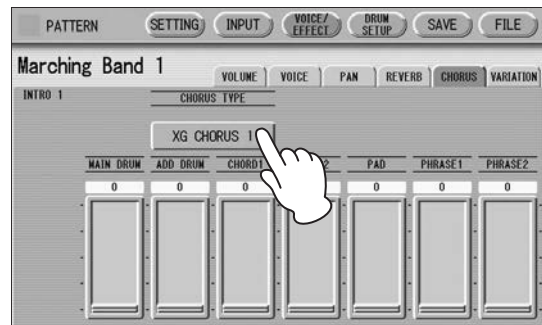

Select the desired chorus type, and the list automatically closes.

2 Chorus sliders

Determines the amount of chorus effect applied to each accompaniment part.

Range: 0 – 127

VARIATION display

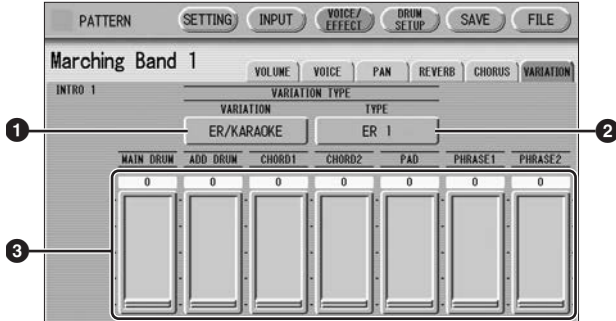

1 VARIATION (Variation Effect Category)

Selects the effect category of the variation effect. Pressing the VARIATION button calls up the effect category list.

Reference page

- Effect List (page 54)

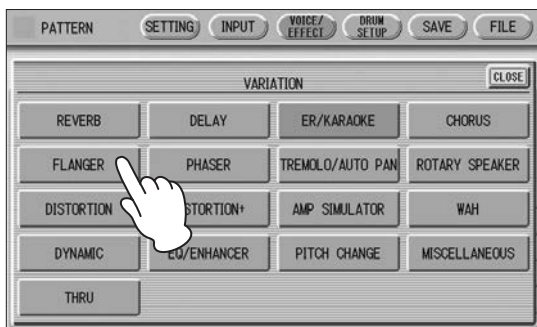
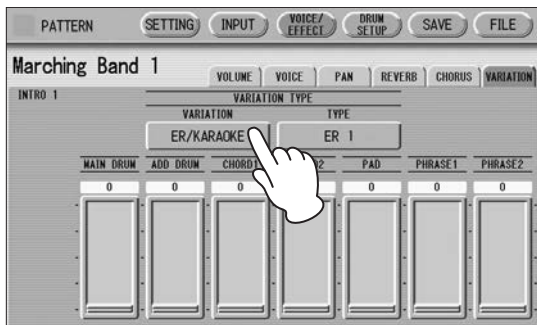

Select the desired effect category, and the list automatically closes.

After changing the category, the variation type below automatically changes corresponding to the selected category.

2 TYPE (Variation Type)

Determines the type of the variation effect. Pressing the TYPE button calls up the effect type list.

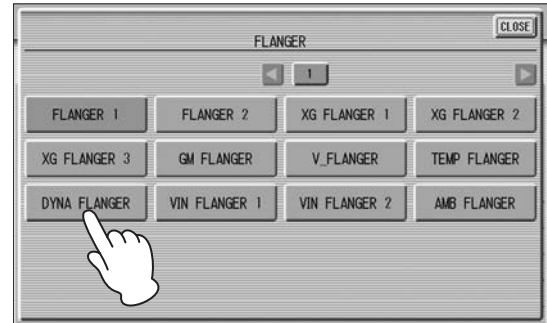
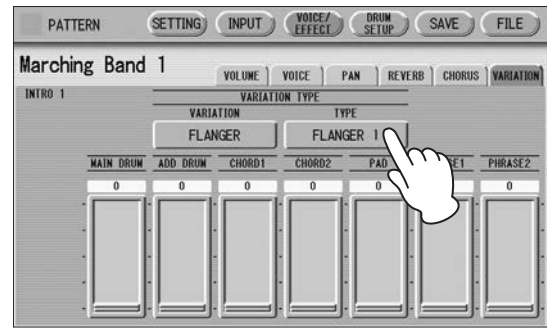

Select the desired type, and the list automatically closes.

3 Variation sliders

Determines the amount of Variation effect applied to each accompaniment part.

Range: 0 – 127

Detailed settings for each percussion instrument

You can independently adjust the settings of pan, pitch, reverb and volume for each instrument.

1 Press the [DRUM SETUP] button at the top of the display to call up the DRUM SETUP Page.

2 Select the desired part, Main Drum or Add Drum.

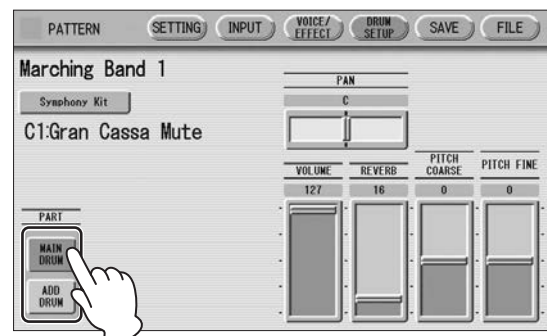

3 Press the appropriate key (the key to which the instrument to be changed is assigned).

The selected instrument's name is shown on the display and you can change its settings.

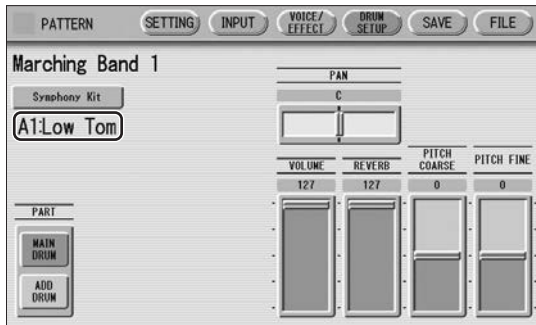

4 Adjust the parameters: Pan, Volume, Reverb and Pitch.

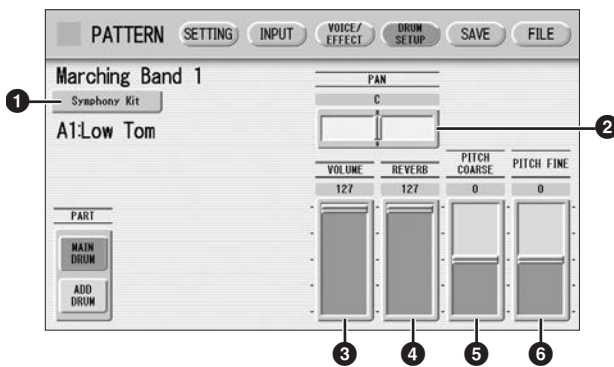

1 Percussion Kit Name

Indicates the currently selected kit. Pressing this button calls up the Percussion Kit list, letting you select the desired kit. When you change the kit, the instruments you have already entered are replaced with the instruments of the newly selected kit.

Reference page

- Percussion Kit List (page 164)

2 PAN

Determines the position of the currently selected instrument in the stereo image.

Range: L63 – R63

3 VOLUME

Determines the volume of the currently selected instrument.

Range: 0 – 127

4 REVERB

Determines the amount of reverb applied to the currently selected instrument.

Range: 0 – 127

5 PITCH COARSE

Determines the pitch of the currently selected instrument, adjustable in semitone (100-cent) steps.

Range: -64 – +63

6 PITCH FINE

Determines the pitch of the currently selected instrument, adjustable in 1-cent steps, allowing more detailed tuning of the instrument than in PITCH COARSE (5) above.

Range: -64 – +63

Saving rhythm patterns

You can save your newly created rhythm pattern as a User Rhythm, up to a maximum of 48 patterns.

1 If necessary, confirm the contents of the rhythm you want to save.

Confirming rhythm patterns before saving

The rhythm pattern you have created will be saved with 15 sections collectively into one rhythm. Before saving, we recommend that you confirm the contents of each section.

Example: When saving the Main A and Main B sections you have created into one user rhythm

First select “Main A” by using the [SECTION] button on the SETTING Page, then press the [START] button on the panel. This lets you hear the Main A pattern you have created.

Confirm that the rhythm pattern is what you want to save as Main A. Next, select “Main B” by using the [SECTION] button, then play it back and confirm that this is what you want to save as Main B.

If the Main A and/or Main B patterns contain undesired data or no data, create the desired data by using the Assemble function (page 149).

After confirming the desired section (Main A and Main B here), we recommend that you confirm that all other sections contain no data. If unnecessary data is contained in some sections which you don't want to save, delete that unnecessary data. This can reduce the data size of the user rhythm.

2 Press the [SAVE] button at the top right of the display to call up the SAVE Page.

If the rhythm is playing, it will automatically be stopped.

3 Select the User Rhythm number to which you wish to save.

The following display appears, prompting confirmation of the operation.

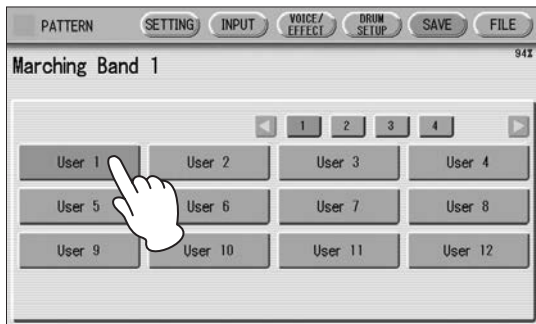

4 Press the [SAVE] button to save the pattern, or press [CANCEL] to abort the operation.

After saving the Rhythm, be sure to quit Rhythm Pattern Program before turning the power off. Turning off the Electone without quitting Rhythm Pattern Program erases the User Rhythm you have created.

Quitting the Rhythm Pattern Program

You can quit the Rhythm Pattern Program from any of its display pages.

1 Press the [PATTERN] button.

If a rhythm is playing, it will automatically be stopped.

If you leave Rhythm Pattern Program without having edited any patterns, this simply quits the Rhythm Pattern Program.

If you have not saved the edited pattern, a message appears, prompting confirmation of the operation.

2 Select [EXIT] to leave Rhythm Pattern Program, or [CANCEL] to abort the operation and return to the previous display.

NOTICE

When you leave the Rhythm Pattern Program, the square at the top left in the display turns light blue for a few seconds, indicating that data is currently being saved. Do not turn the power off while the data is being saved.

Checking the Remaining Memory Capacity

Remaining Memory (amount of memory available for storing rhythms) is shown on the display as a percentage.



If a "Data full" message appears when you press the [SAVE] button, the pattern cannot be saved because of lack of available memory space. If this occurs, check through all fifteen sections for any unnecessary data. After erasing some of the less necessary data, try to save the pattern again.

To avoid this, you should periodically check the amount of remaining memory while you are creating your rhythm.

Reference pages

- Confirming rhythm patterns before saving (page 161)
- CLEAR PART (page 150)

Recalling User rhythm patterns

The User rhythms you have created in the Rhythm Pattern Program can be selected and played from the User buttons in the panel Rhythm section. Refer to Chapter 5, “Selecting Rhythms from the User buttons” (page 60).

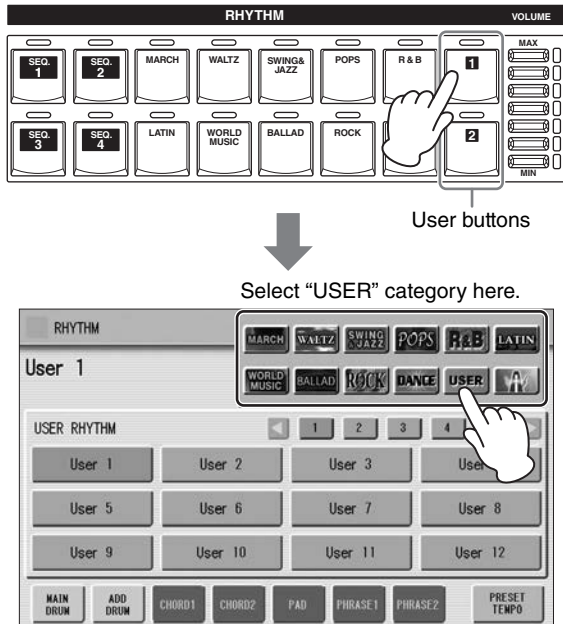

4 Press the [SELECT] button to select the desired pattern file.

The method for selecting a file is the same as that in the MDR section. See page 108 for more information.

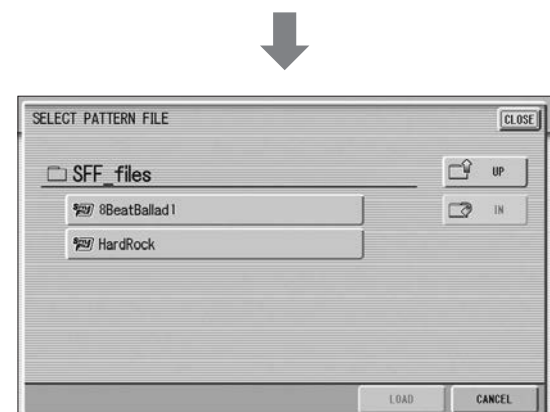

5 Press the [LOAD] button to load the pattern.

To edit the loaded pattern, go to the INPUT Page (page 152), then save your created pattern(s) as a User Rhythm (page 161).

Selecting rhythms from a USB flash drive

You can load rhythms from a USB flash drive and edit and save them as User Rhythms. Data that can be loaded includes not only that of the Electone, but also all Style File Format files.

- 1 Insert the USB flash drive which contains the desired pattern into the [USB TO DEVICE] terminal.
- 2 Press the [PATTERN] button on the panel.
- 3 Press [FILE] at the top right in the display.

If you open the FILE Page while the rhythm is playing, the rhythm will automatically be stopped.

About file types that can be loaded to the Electone

This Electone is compatible with Style File Format data.

The Style File Format (SFF) is Yamaha's original Style data format, which uses a unique conversion system to provide high-quality automatic accompaniment based on a wide range of chord types. In this format, each rhythm pattern (called a "Style") is made up of fifteen sections (Intro 1 - 3, Main A - D, Fill In A - D, Break, Ending 1 - 3) as rhythm pattern variations. Each of these fifteen sections in turn has eight different parts, made up of MIDI sequence data.

You can load any patterns (Styles) which have been created by an SFF-compatible instrument.



Lower Keyboard

Upper Keyboard

		Drum					
		Rock Kit	Electro Kit	Analog Kit	Dance Kit	Jazz Kit	Brush Kit
C-1	C#-1	Surdo Mute	Surdo Mute	Surdo Mute	Kick Dance 1	Surdo Mute	Surdo Mute
D-1		Surdo Open	Surdo Open	Surdo Open	Kick Dance 2	Surdo Open	Surdo Open
E-1	D#-1	Hi Q	Hi Q	Hi Q	Hi Q	Hi Q	Hi Q
F-1		Whip Slap	Whip Slap	Whip Slap	Whip Slap	Whip Slap	Whip Slap
G-1	F#-1	Scratch H	Scratch H	Scratch H	Scratch Dance 1 *	Scratch H	Scratch H
A-1		Scratch L	Scratch L	Scratch L	Scratch Dance 2 *	Scratch L	Scratch L
B-1	G#-1	Finger Snap	Finger Snap	Finger Snap	Finger Snap	Finger Snap	Finger Snap
C0		Click Noise	Click Noise	Click Noise	Click Noise	Click Noise	Click Noise
D0	D#0	Metronome Click	Metronome Click	Metronome Click	Dance Perc 1	Metronome Click	Metronome Click
E0		Metronome Bell	Metronome Bell	Metronome Bell	Reverse Dance 1	Metronome Bell	Metronome Bell
F0	F#0	Seq Click L	Seq Click L	Seq Click L	Dance Perc 2	Seq Click L	Seq Click L
G0		Seq Click H	Seq Click H	Seq Click H	Hi Q Dance 1	Seq Click H	Seq Click H
A0	A#0	Brush Tap	Brush Tap	Brush Tap	Snare Analog 3	Brush Tap	Brush Tap
B0		Brush Swirl *	Brush Swirl *	Brush Swirl *	Vinyl Noise *	Brush Swirl *	Brush Swirl *
C1	C#1	Brush Slap	Brush Slap	Brush Slap	Snare Analog 4	Brush Slap	Brush Slap *
D1	D#1	Brush Tap Swirl *	Reverse Cymbal *	Reverse Cymbal *	Reverse Cymbal *	Brush Tap Swirl *	Brush Tap Swirl
E1		Snare Roll *	Snare Roll *	Snare Roll *	Reverse Dance 2 *	Snare Roll *	Snare Roll *
F1	F#1	Castanet	Hi Q 2	Hi Q 2	Hi Q 2	Castanet	Castanet
G1	G#1	Snare Noisy	Snare Snap Elec	Snare Noisy 4	Snare Techno	Snare Jazz H	Brush Slap 2
A1	A#1	Sticks	Sticks	Sticks	Snare Dance 1	Sticks	Sticks
B1		Kick Soft	Kick 3	Kick 3	Kick Techno Q	Kick Soft	Kick Soft
C2	C#2	Open Rim Shot	Open Rim Shot	Open Rim Shot	Rim Gate	Open Rim Shot	Open Rim Shot
D2	D#2	Kick 2	Kick 2	Kick Anlg Short	Kick Techno L	Kick Tight	Kick Tight
E2		Kick Gate	Kick Gate Heavy	Kick Analog	Kick Techno	Kick Jazz	Kick Jazz
F2	F#2	Side Stick	Side Stick	Side Stick Anlg	Side Stick Anlg	Side Stick Light	Side Stick Light
G2	G#2	Snare Rock	Snare Noisy 2	Snare Analog	Snare Clap	Snare Jazz L	Brush Slap 3
A2	A#2	Hand Clap	Hand Clap	Hand Clap	Dance Clap	Hand Clap	Hand Clap
B2		Snare Rock Tight	Snare Noisy 3	Snare Analog 2	Snare Dry	Snare Jazz M	Brush Tap 2
C3	C#3	Tom Rock 1	Tom Electro 1	Tom Analog 1	Tom Dance 1	Floor Tom L	Tom Brush 1
D3	D#3	Hi-Hat Closed	Hi-Hat Closed	Hat Close Analog	Hi-Hat Closed 3	Hi-Hat Closed	Hi-Hat Closed
E3		Tom Rock 2	Tom Electro 2	Tom Analog 2	Tom Dance 2	Floor Tom H	Tom Brush 2
F3	F#3	Hi-Hat Pedal	Hi-Hat Pedal	Hat Close Anlg 2	Hat Close Anlg 3	Hi-Hat Pedal	Hi-Hat Pedal
G3	G#3	Tom Rock 3	Tom Electro 3	Tom Analog 3	Tom Dance 3	Low Tom	Tom Brush 3
A3	A#3	Hi-Hat Open	Hi-Hat Open	Hat Open Analog	Hi-Hat Open 3	Hi-Hat Open	Hi-Hat Open
B3		Tom Rock 4	Tom Electro 4	Tom Analog 4	Tom Dance 4	Mid Tom L	Tom Brush 4
C4	C#4	Tom Rock 5	Tom Electro 5	Tom Analog 5	Tom Dance 5	Mid Tom H	Tom Brush 5
D4	D#4	Crash Cymbal 1	Crash Cymbal 1	Crash Analog	Crash Analog	Crash Cymbal 1	Crash Cymbal 1
E4		Tom Rock 6	Tom Electro 6	Tom Analog 6	Tom Dance 6	High Tom	Tom Brush 6
F4	F#4	Ride Cymbal 1	Ride Cymbal 1	Ride Cymbal 1	Ride Cymbal 1	Ride Cymbal 1	Ride Cymbal 1
G4	G#4	Chinese Cymbal	Chinese Cymbal	Chinese Cymbal	Chinese Cymbal	Chinese Cymbal	Chinese Cymbal
A4	A#4	Ride Cymbal Cup	Ride Cymbal Cup	Ride Cymbal Cup	Ride Cymbal Cup	Ride Cymbal Cup	Ride Cymbal Cup
B4		Tambourine	Tambourine	Tambourine	Tambourine Anlg	Tambourine	Tambourine
C5	C#5	Splash Cymbal	Splash Cymbal	Splash Cymbal	Splash Cymbal	Splash Cymbal	Splash Cymbal
D5	D#5	Cowbell	Cowbell	Cowbell Analog	Cowbell Dance	Cowbell	Cowbell
E5		Crash Cymbal 2	Crash Cymbal 2	Crash Cymbal 2	Crash Cymbal 2	Crash Cymbal 2	Crash Cymbal 2
F5	F#5	Vibraslap	Vibraslap	Vibraslap	Vibraslap Analog	Vibraslap	Vibraslap
G5	G#5	Ride Cymbal 2	Ride Cymbal 2	Ride Cymbal 2	Ride Analog	Ride Cymbal 2	Ride Cymbal 2
A5	A#5	Bongo H	Bongo H	Bongo H	Bongo Analog H	Bongo H	Bongo H
B5		Bongo L	Bongo L	Bongo L	Bongo Analog L	Bongo L	Bongo L
C6	C#6	Conga H Mute	Conga H Mute	Conga Analog H	Conga Analog H	Conga H Mute	Conga H Mute
D6	D#6	Conga H Open	Conga H Open	Conga Analog M	Conga Analog M	Conga H Open	Conga H Open
E6		Conga L	Conga L	Conga Analog L	Conga Analog L	Conga L	Conga L
F6	F#6	Timbale H	Timbale H	Timbale H	Timbale H	Timbale H	Timbale H
G6	G#6	Timbale L	Timbale L	Timbale L	Timbale L	Timbale L	Timbale L
A6	A#6	Agogo H	Agogo H	Agogo H	Agogo H	Agogo H	Agogo H
B6		Agogo L	Agogo L	Agogo L	Agogo L	Agogo L	Agogo L
C7	C#7	Cabasa	Cabasa	Cabasa	Cabasa	Cabasa	Cabasa
D7	D#7	Maracas	Maracas	Maracas 2	Maracas 2	Maracas	Maracas
E7		Samba Whistle H *	Samba Whistle H *	Samba Whistle H *	Samba Whistle H *	Samba Whistle H *	Samba Whistle H *
F7	F#7	Samba Whistle L *	Samba Whistle L *	Samba Whistle L *	Samba Whistle L *	Samba Whistle L *	Samba Whistle L *
G7	G#7	Guiro Short	Guiro Short	Guiro Short	Guiro Short	Guiro Short	Guiro Short
A7	A#7	Guiro Long *	Guiro Long *	Guiro Long *	Guiro Long *	Guiro Long *	Guiro Long *
B7		Claves	Claves	Claves 2	Claves 2	Claves	Claves
C8	C#8	Wood Block H	Wood Block H	Wood Block H	Dance Perc 3	Wood Block H	Wood Block H
D8	D#8	Wood Block L	Wood Block L	Wood Block L	Dance Perc 4 *	Wood Block L	Wood Block L
E8		Cuica Mute	Scratch H 2	Scratch H 2	Dance Breath 1	Cuica Mute	Cuica Mute
F8	F#8	Cuica Open	Scratch L 2	Scratch L 2	Dance Breath 2 *	Cuica Open	Cuica Open
G8	G#8	Triangle Mute	Triangle Mute	Triangle Mute	Triangle Mute	Triangle Mute	Triangle Mute
A8	A#8	Triangle Open	Triangle Open	Triangle Open	Triangle Open	Triangle Open	Triangle Open
B8		Shaker	Shaker	Shaker	Shaker	Shaker	Shaker
C9	C#9	Jingle Bells	Jingle Bells	Jingle Bells	Jingle Bells	Jingle Bells	Jingle Bells
D9	D#9	Bell Tree	Bell Tree	Bell Tree	Bell Tree	Bell Tree	Bell Tree
E9							
F9	F#9						
G9	G#9						

*: Indicates an instrument which requires the Gate Time setting.

		Drum						
		Symphony Kit	China Mix Kit	Live!Std Kit	Live!Std+P Kit	Live!Funk Kit	Live!Funk+P Kit	
Lower Keyboard	C-1	C#-1	Surdo Mute	Surdo Mute	Surdo Mute	Surdo Mute	Surdo Mute	Surdo Mute
	D-1	D#-1	Surdo Open	Surdo Open	Surdo Open	Surdo Open	Surdo Open	Surdo Open
	E-1		Hi Q	Hi Q	Hi Q	Hi Q	Hi Q	Hi Q
	F-1	F#-1	Whip Slap	Whip Slap	Whip Slap	Whip Slap	Whip Slap	Whip Slap
	G-1	G#-1	Scratch H	Scratch H	Scratch H	Scratch H	Scratch H	Scratch H
	A-1	A#-1	Scratch L	Scratch L	Scratch L	Scratch L	Scratch L	Scratch L
	B-1		Finger Snap	Finger Snap	Finger Snap	Finger Snap	Finger Snap	Finger Snap
	C0	C#0	Click Noise	Click Noise	Click Noise	Click Noise	Click Noise	Click Noise
	D0	D#0	Metronome Click	Metronome Click	Metronome Click	Metronome Click	Metronome Click	Metronome Click
	E0		Metronome Bell	Metronome Bell	Metronome Bell	Metronome Bell	Metronome Bell	Metronome Bell
	F0	F#0	Seq Click L	Seq Click L	Seq Click L	Seq Click L	Seq Click L	Seq Click L
	G0	G#0	Seq Click H	Seq Click H	Seq Click H	Seq Click H	Seq Click H	Seq Click H
	A0	A#0	Brush Tap	Brush Tap	Brush Tap	Brush Tap	Brush Tap	Brush Tap
	B0		Brush Swirl *	Brush Swirl *	Brush Swirl *	Brush Swirl *	Brush Swirl *	Brush Swirl *
	C1	C#1	Brush Slap	Brush Slap	Brush Slap	Brush Slap	Brush Slap	Brush Slap
	D1	D#1	Brush Tap Swirl *	Brush Tap Swirl *	Brush Tap Swirl *	Brush Tap Swirl *	Brush Tap Swirl *	Brush Tap Swirl *
	E1		Snare Roll *	Snare Roll *	Snare Roll *	Snare Roll *	Snare Roll *	Snare Roll *
	F1	F#1	Castanet	Castanet	Castanet	Castanet	Castanet	Castanet
	G1	G#1	Snare Soft	Snare Soft	Snare Soft	Snare Soft	Snare Soft 2	Snare Soft 2
	A1	A#1	Sticks	Sticks	Sticks	Sticks	Sticks	Sticks
	B1		Kick Soft 2	Kick Soft	Kick Soft	Kick Soft	Kick Soft	Kick Soft
	C2	C#2	Open Rim Shot	Open Rim Shot	Open Rim Shot	Open Rim Shot	Open Rim Shot H	Open Rim Shot H
	D2	D#2	Gran Cassa	Kick Tight	Kick Tight	Kick Tight	Kick Tight	Kick Tight
	E2		Gran Cassa Mute	Kick	Kick	Kick	Kick Short	Kick Short
	F2	F#2	Side Stick	Side Stick	Side Stick	Side Stick	Side Stick Light	Side Stick Light
	G2	G#2	Band Snare	Snare	Snare	Snare	Snare Short	Snare Short
	A2	A#2	Hand Clap	Hand Clap	Hand Clap	Hand Clap	Hand Clap	Hand Clap
	B2		Band Snare 2	Snare Tight	Snare Tight	Snare Tight	Snare Tight H	Snare Tight H
	C3	C#3	Floor Tom L	Floor Tom L	Floor Tom L	Floor Tom L	Floor Tom L	Floor Tom L
	D3	D#3	Hi-Hat Closed	Hi-Hat Closed	Hi-Hat Closed	Hi-Hat Closed	Hi-Hat Closed	Hi-Hat Closed
	E3		Floor Tom H	Floor Tom H	Floor Tom H	Floor Tom H	Floor Tom H	Floor Tom H
	F3	F#3	Hi-Hat Pedal	Hi-Hat Pedal	Hi-Hat Pedal	Hi-Hat Pedal	Hi-Hat Pedal	Hi-Hat Pedal
	G3	G#3	Low Tom	Low Tom	Low Tom	Low Tom	Low Tom	Low Tom
A3	A#3	Hi-Hat Open	Hi-Hat Open	Hi-Hat Open	Hi-Hat Open	Hi-Hat Open	Hi-Hat Open	
B3		Mid Tom L	Mid Tom L	Mid Tom L	Mid Tom L	Mid Tom L	Mid Tom L	
C4	C#4	Mid Tom H	Mid Tom H	Mid Tom H	Mid Tom H	Mid Tom H	Mid Tom H	
D4	D#4	Hand Cymbal	Crash Cymbal 1	Crash Cymbal 1	Crash Cymbal 1	Crash Cymbal 1	Crash Cymbal 1	
E4		High Tom	High Tom	High Tom	High Tom	High Tom	High Tom	
F4	F#4	Hand Cymbal S	Ride Cymbal 1	Ride Cymbal 1	Ride Cymbal 1	Ride Cymbal 1	Ride Cymbal 1	
G4	G#4	Chinese Cymbal	China Cymbal	Chinese Cymbal	Chinese Cymbal	Chinese Cymbal	Chinese Cymbal	
A4	A#4	Ride Cymbal Cup	Ride Cymbal Cup	Ride Cymbal Cup	Ride Cymbal Cup	Ride Cymbal Cup	Ride Cymbal Cup	
B4		Tambourine	Tambourine	Tambourine	Tambourine	Tambourine	Tambourine	
C5	C#5	Splash Cymbal	Splash Cymbal	Splash Cymbal	Splash Cymbal	Splash Cymbal	Splash Cymbal	
D5	D#5	Cowbell	Cowbell	Cowbell	Cowbell	Cowbell	Cowbell	
E5		Hand Cymbal 2	Crash Cymbal 2	Crash Cymbal 2	Crash Cymbal 2	Crash Cymbal 2	Crash Cymbal 2	
F5	F#5	Vibraslap	Vibraslap	Vibraslap	Vibraslap	Vibraslap	Vibraslap	
G5		Hand Cymbal 2 S	Ride Cymbal 2	Ride Cymbal 2	Ride Cymbal 2	Ride Cymbal 2	Ride Cymbal 2	
Upper Keyboard		C3	Bongo H	Bongo H	Bongo H	Bongo H	Bongo H	Bongo H
		D3	Bongo L	Bongo L	Bongo L	Bongo L	Bongo L	Bongo L
		E3	Conga H Mute	Conga H Mute	Conga H Mute	Conga H Mute	Conga H Mute	Conga H Mute
		F3	Conga H Open	Conga H Open	Conga H Open	Conga H Open	Conga H Open	Conga H Open
		G3	Conga L	Conga L	Conga L	Conga L	Conga L	Conga L
		A3	Timbale H	Timbale H	Timbale H	Timbale H	Timbale H	Timbale H
		B3	Timbale L	Timbale L	Timbale L	Timbale L	Timbale L	Timbale L
		C4	Agogo H	Dagu Mute	Agogo H	Agogo H	Agogo H	Agogo H
		D4	Agogo L	Zhongcha Mute	Agogo L	Agogo L	Agogo L	Agogo L
		E4	Cabasa	Dagu Heavy	Cabasa	Cabasa	Cabasa	Cabasa
		F4	Maracas	Zhongcha Open	Maracas	Maracas	Maracas	Maracas
		G4	Samba Whistle H *	Paigu Middle	Samba Whistle H *	Samba Whistle H *	Samba Whistle H *	Samba Whistle H *
		A4	Samba Whistle L *	Paigu Low	Samba Whistle L *	Samba Whistle L *	Samba Whistle L *	Samba Whistle L *
		B4	Guiro Short	Xiaocha Mute	Guiro Short	Guiro Short	Guiro Short	Guiro Short
		C5	Guiro Long *	Bangu	Guiro Long *	Guiro Long *	Guiro Long *	Guiro Long *
D5	Claves	Xiaocha Open	Claves	Claves	Claves	Claves		
E5	Wood Block H	Bangzi	Wood Block H	Wood Block H	Wood Block H	Wood Block H		
F5	Wood Block L	Muyu Low	Wood Block L	Wood Block L	Wood Block L	Wood Block L		
G5	Cuica Mute	Zhongluo Mute	Cuica Mute	Cuica Mute	Cuica Mute	Cuica Mute		
A5	Cuica Open	Muyu Mid-Low	Cuica Open	Cuica Open	Cuica Open	Cuica Open		
B5	Triangle Mute	Zhongluo Open	Triangle Mute	Triangle Mute	Triangle Mute	Triangle Mute		
C6	Triangle Open	Muyu Middle	Triangle Open	Triangle Open	Triangle Open	Triangle Open		
D6	Shaker	Xiaoluo Open	Shaker	Shaker	Shaker	Shaker		
E6	Jingle Bells	Muyu Mid-High	Jingle Bells	Jingle Bells	Jingle Bells	Jingle Bells		
F6	Bell Tree	Muyu High	Bell Tree	Bell Tree	Bell Tree	Bell Tree		
G6								

*: Indicates an instrument which requires the Gate Time setting.

		Drum						
		Live!Brush Kit	Live!Brush+P Kit	Live!Studio Kit	Live!AcousticKit	Live!Power Kit 1	Live!Power Kit 2	
Lower Keyboard	C-1	C#-1	Surdo Mute	Surdo Mute	Surdo Mute	Surdo Mute	Surdo Mute	Surdo Mute
	D-1	D#-1	Surdo Open	Surdo Open	Surdo Open	Surdo Open	Surdo Open	Surdo Open
	E-1		Hi Q	Hi Q	Hi Q	Hi Q	Hi Q	Hi Q
	F-1	F#-1	Whip Slap	Whip Slap	Whip Slap	Whip Slap	Whip Slap	Whip Slap
	G-1	G#-1	Scratch H	Scratch H	Scratch H	Scratch H	Scratch H	Scratch H
	A-1	A#-1	Scratch L	Scratch L	Scratch L	Scratch L	Scratch L	Scratch L
	B-1		Finger Snap	Finger Snap	Finger Snap	Finger Snap	Finger Snap	Finger Snap
	C0	C#0	Click Noise	Click Noise	Click Noise	Click Noise	Click Noise	Click Noise
	D0	D#0	Metronome Click	Metronome Click	Metronome Click	Metronome Click	Metronome Click	Metronome Click
	E0		Metronome Bell	Metronome Bell	Metronome Bell	Metronome Bell	Metronome Bell	Metronome Bell
	F0	F#0	Seq Click L	Seq Click L	Seq Click L	Seq Click L	Seq Click L	Seq Click L
	G0	G#0	Seq Click H	Seq Click H	Seq Click H	Seq Click H	Seq Click H	Seq Click H
	A0	A#0	Brush Tap	Brush Tap	Brush Tap	Brush Tap	Brush Tap	Brush Tap
	B0		Brush Swirl *	Brush Swirl *	Brush Swirl *	Brush Swirl *	Brush Swirl *	Brush Swirl *
	C1	C#1	Brush Slap	Brush Slap	Brush Slap	Brush Slap	Brush Slap	Brush Slap
	D1	D#1	Brush Tap Swirl *	Brush Tap Swirl *	Brush Tap Swirl *	Brush Tap Swirl *	Brush Tap Swirl *	Brush Tap Swirl *
	E1		Snare Roll *	Snare Roll *	Snare Roll *	Snare Roll Aco *	Snare Roll *	Snare Roll *
	F1	F#1	Castanet	Castanet	Castanet	Castanet	Castanet	Castanet
	G1	G#1	Brush Slap 2	Brush Slap 2	Snare Studio 2	Snare Soft Aco	SnareSoftPower 1	SnareSoftPower 2
	A1	A#1	Sticks	Sticks	Sticks	Sticks	Sticks	Sticks
	B1		Kick Soft	Kick Soft	Kick Ambience H	Kick Soft Aco	Kick Ambient+	Kick Ambient+
	C2	C#2	Open Rim Shot	Open Rim Shot	Open Rim Shot	Rim Acoustic	Open Rim Power 1	Open Rim Power 2
	D2	D#2	Kick Tight	Kick Tight	Kick Ambience L	Kick Mute Aco	Kick Power Open	Kick Power Open
	E2		Kick Jazz	Kick Jazz	Kick Studio	Kick Open Aco	Kick Power Mute	Kick Power Mute
	F2	F#2	Side Stick Light	Side Stick Light	Side Stick	Stick Acoustic	Side Stick Power	Side Stick Power
	G2	G#2	Brush Slap 3	Brush Slap 3	Snare Studio M	Snare Acoustic	Snare Power 1	Snare Power 2
	A2	A#2	Hand Clap	Hand Clap	Hand Clap	Hand Clap Power	Hand Clap Power	Hand Clap Power
	B2		Brush Tap 2	Brush Tap 2	Snare Studio L	Snare Rough Aco	Snare Rough 1	Snare Rough 2
	C3	C#3	Tom Brush 1	Tom Brush 1	Floor Tom L	Tom Acoustic 1	Tom Power 1	Tom Power 2
	D3	D#3	Hi-Hat Closed	Hi-Hat Closed	Hi-Hat Closed	Hi-HatClosedAco	Hi-HatClosePower	HH Closed PW Eg
	E3		Tom Brush 2	Tom Brush 2	Floor Tom H	Tom Acoustic 2	Tom Power 2	Tom Power 2
	F3	F#3	Hi-Hat Pedal	Hi-Hat Pedal	Hi-Hat Pedal	Hi-HatPedal Aco	Hi-HatPedalPower	Hi-HatPedalPower
	G3	G#3	Tom Brush 3	Tom Brush 3	Low Tom	Tom Acoustic 3	Tom Power 3	Tom Power 3
	A3	A#3	Hi-Hat Open	Hi-Hat Open	Hi-Hat Open	Hi-Hat Open Aco	Hi-HatOpenPower	Hi-HatOpenPower
B3		Tom Brush 4	Tom Brush 4	Mid Tom L	Tom Acoustic 4	Tom Power 4	Tom Power 4	
C4	C#4	Tom Brush 5	Tom Brush 5	Mid Tom H	Tom Acoustic 5	Tom Power 5	Tom Power 5	
D4	D#4	Crash Cymbal 1	Crash Cymbal 1	Crash Cymbal 1	CrashCymbalAco 1	CrashCymbalAco 1	CrashCymbalAco 1	
E4		Tom Brush 6	Tom Brush 6	High Tom	Tom Acoustic 6	Tom Power 6	Tom Power 6	
F4	F#4	Ride Cymbal 1	Ride Cymbal 1	Ride Cymbal 1	RideCymbal Aco 1	RideCymbal Aco 1	RideCymbal Aco 1	
G4	G#4	Chinese Cymbal	Chinese Cymbal	Chinese Cymbal	China Cymbal Aco	China Cymbal Aco	China Cymbal Aco	
A4	A#4	Ride Cymbal Cup	Ride Cymbal Cup	Ride Cymbal Cup	RideCymbalCupAco	RideCymbalCupAco	RideCymbalCupAco	
B4		Tambourine	Tambourine	Tambourine	Tambourine	Tambourine	Tambourine	
C5	C#5	Splash Cymbal	Splash Cymbal	Splash Cymbal	SplashCymbal Aco	SplashCymbal Aco	SplashCymbal Aco	
D5	D#5	Cowbell	Cowbell	Cowbell	Cowbell	Cowbell	Cowbell	
E5		Crash Cymbal 2	Crash Cymbal 2	Crash Cymbal 2	CrashCymbalAco 2	CrashCymbalAco 2	CrashCymbalAco 2	
F5	F#5	Vibraslap	Vibraslap	Vibraslap	Vibraslap	Vibraslap	Vibraslap	
G5		Ride Cymbal 2	Ride Cymbal 2	Ride Cymbal 2	RideCymbal Aco 2	RideCymbal Aco 2	RideCymbal Aco 2	
A5	A#5	Bongo H	Bongo H	Bongo H	Bongo H	Bongo H	Bongo H	
B5		Bongo L	Bongo L	Bongo L	Bongo L	Bongo L	Bongo L	
C6	C#6	Conga H Mute	Conga H Mute	Conga H Mute	Conga H Mute	Conga H Mute	Conga H Mute	
D6	D#6	Conga H Open	Conga H Open	Conga H Open	Conga H Open	Conga H Open	Conga H Open	
E6		Conga L	Conga L	Conga L	Conga L	Conga L	Conga L	
F6	F#6	Timbale H	Timbale H	Timbale H	Timbale H	Timbale H	Timbale H	
G6	G#6	Timbale L	Timbale L	Timbale L	Timbale L	Timbale L	Timbale L	
A6	A#6	Agogo H	Agogo H	Agogo H	Agogo H	Agogo H	Agogo H	
B6		Agogo L	Agogo L	Agogo L	Agogo L	Agogo L	Agogo L	
C7	C#7	Cabasa	Cabasa	Cabasa	Cabasa	Cabasa	Cabasa	
D7	D#7	Maracas	Maracas	Maracas	Maracas	Maracas	Maracas	
E7		Samba Whistle H *	Samba Whistle H *	Samba Whistle H *	Samba Whistle H *	Samba Whistle H *	Samba Whistle H *	
F7	F#7	Samba Whistle L *	Samba Whistle L *	Samba Whistle L *	Samba Whistle L *	Samba Whistle L *	Samba Whistle L *	
G7	G#7	Guiro Short	Guiro Short	Guiro Short	Guiro Short	Guiro Short	Guiro Short	
A7	A#7	Guiro Long *	Guiro Long *	Guiro Long *	Guiro Long *	Guiro Long *	Guiro Long *	
B7		Claves	Claves	Claves	Claves	Claves	Claves	
C8	C#8	Wood Block H	Wood Block H	Wood Block H	Wood Block H	Wood Block H	Wood Block H	
D8	D#8	Wood Block L	Wood Block L	Wood Block L	Wood Block L	Wood Block L	Wood Block L	
E8		Cuica Mute	Cuica Mute	Cuica Mute	Cuica Mute	Cuica Mute	Cuica Mute	
F8	F#8	Cuica Open	Cuica Open	Cuica Open	Cuica Open	Cuica Open	Cuica Open	
G8	G#8	Triangle Mute	Triangle Mute	Triangle Mute	Triangle Mute	Triangle Mute	Triangle Mute	
A8	A#8	Triangle Open	Triangle Open	Triangle Open	Triangle Open	Triangle Open	Triangle Open	
B8		Shaker	Shaker	Shaker	Shaker	Shaker	Shaker	
C9	C#9	Jingle Bells	Jingle Bells	Jingle Bells	Jingle Bells	Jingle Bells	Jingle Bells	
D9	D#9	Bell Tree	Bell Tree	Bell Tree	Wind Chime	Wind Chime	Wind Chime	
E9								
F9	F#9							
G9	G#9							

*: Indicates an instrument which requires the Gate Time setting.

		Drum						
		Live!Rock Kit	Live!Real Drums	Live!RealBrushes	Analog T8 Kit	Analog T9 Kit	House Kit	
Lower Keyboard	C-1	C#-1	Surdo Mute	Surdo Mute	Surdo Mute	Surdo Mute	Surdo Mute	W Kick *
	D-1	D#-1	Surdo Open	Surdo Open	Surdo Open	Surdo Open	Surdo Open	Disco Fx *
	E-1	E#-1	Hi Q	Hi Q	Hi Q	Hi Q	Hi Q	WhiteNoiseDown 1 *
	F-1	F#-1	Whip Slap	Whip Slap	Whip Slap	Whip Slap	Whip Slap	PinkNoise Down 1 *
	G-1	G#-1	Scratch H	Scratch H	Scratch H	Scratch H	Scratch H	WhiteNoiseDown 2 *
	A-1	A#-1	Scratch L	Scratch L	Scratch L	Scratch L	Scratch L	PinkNoise Down 2 *
	B-1	B#-1	Finger Snap	Finger Snap	Finger Snap	Snare Hammer	Snare Drum&Bass1	White Noise Up 2 *
	C0	C#0	Click Noise	Click Noise	Click Noise	Kick Zap Hard	Kick Break 2	White Noise Up 1 *
	D0	D#0	Metronome Click	Metronome Click	Metronome Click	Snare Garg L	Snare Distortion	Pink Noise Up *
	E0	E#0	Metronome Bell	Metronome Bell	Metronome Bell	Kick Tek Power	Kick Tek Power	WhiteNoiseUp Rel *
	F0	F#0	Seq Click L	Seq Click L	Vintage Tip	Kick Slimy	KickDistortionRM	PinkNoise Up Rel *
	G0	G#0	Seq Click H	Seq Click H	Vintage Swirl 1 *	Kick T8 4	Kick T9 2	Kick T9 4
	A0	A#0	Brush Tap	Brush Tap	Vintage Slap 1	Snare Analog CR	Snare Analog CR	Snare T8 Rim
	B0	B#0	Brush Swirl *	Brush Tap Swirl *	Vintage Swirl 2 *	Snare T8 7	Snare T9 5	Snare T8 5
	C1	C#1	Brush Slap	Brush Slap	Vintage Slap 2	SnareClap Analog	Clap Analog Sm	Hand Clap
	D1	D#1	Brush Tap Swirl *	Brush Tap Swirl *	Vintage TapSwirl *	Snare T8 6	Snare T9 Gate 1	Snare Garg L
	E1	E#1	Snare Roll Rock *	Snare Roll Rock *	VintageSlapSwirl *	Tom T8 5	Snare Rock Roll *	Snare Roll *
	F1	F#1	Castanet	Castanet	Vintage Swirl 3 *	Snare T8 5	Snare T9 3	Snare T9 3
	G1	G#1	Snare Soft Rock	Snare Tight	Vintage Slap 3	Kick T8 3	Snare T9 4	Snare T8 1
	A1	A#1	Sticks	Sticks	Sticks	Snare T8 4	Snare T9 Gate 2	Snare T9 5
	B1	B#1	Kick Soft Rock	Kick Genuine	Kick Soft L	Kick T8 2	Kick T9 4	Kick T9 1
	C2	C#2	Rim Rock	Rim Real	Open Rim Shot RB	Snare T8 3	Snare T9 6	Snare T9 Gate
	D2	D#2	Kick Rock Heavy	Kick Real 1	Kick Soft H	T8 Kick Bass	Kick T9 1	Kick T9 2
	E2	E#2	Kick Rock	Kick Real 2	KickJazzAmbience	Kick T8 1	Kick T9 3	Kick T9 5
	F2	F#2	Stick Rock	Stick Real	Stick Brush	Snare T8 Rim	Snare T9 Rim	Snare T9 Rim
	G2	G#2	Snare Rock	Snare Real 1	Vintage Slap 4	Snare T8 2	Snare T9 1	Snare T9 1
	A2	A#2	Hand Clap Power	Clap Power	Clap Power	Clap T9	Clap T9	Clap T9
	B2	B#2	Snare Dry Rock	Snare Real 2	Vintage Slap 5	Snare T8 1	Snare T9 2	Snare T9 2
	C3	C#3	Tom Rock 1	Tom Real 1	TomRealBrushes 1	Tom T8 1	Tom T9 1	Tom T9 1
	D3	D#3	Hi-HatClosedRock	Hi-HatClosedReal	Hi-Hat Closed RB	Hi-Hat Closed T8	Hi-Hat Closed T9	Hi-Hat Closed T8
	E3	E#3	Tom Rock 2	Tom Real 2	TomRealBrushes 2	Tom T8 2	Tom T9 2	Tom T9 2
	F3	F#3	Hi-HatPedal Rock	Hi-Hat PedalReal	Hi-Hat Pedal RB	Hi-Hat Pedal T8	Hi-Hat Pedal T9	Hi-Hat Pedal T9
G3	G#3	Tom Rock 3	Tom Real 3	TomRealBrushes 3	Tom T8 3	Tom T9 3	Tom T9 3	
A3	A#3	Hi-Hat Open Rock	Hi-Hat Open Real	Hi-Hat Open RB	Hi-Hat Open T8	Hi-Hat Open T9	Hi-Hat Open T9	
B3	B#3	Tom Rock 4	Tom Real 4	TomRealBrushes 4	Tom T8 4	Tom T9 4	Tom T9 4	
C4	C#4	Tom Rock 5	Tom Real 5	TomRealBrushes 5	Tom T8 6	Tom T9 5	Tom T9 5	
D4	D#4	CrashCymbalAco 1	CrashCymbalReal1	CrashCymbal RB 1	Crash Cymbal T8	Crash Cymbal T9	Crash Cymbal T9	
E4	E#4	Tom Rock 6	Tom Real 6	TomRealBrushes 6	Tom T8 7	Tom T9 6	Tom T9 6	
F4	F#4	RideCymbal Aco 1	RideCymbalReal 1	Ride Cymbal RB	Ride Cymbal T9	Ride Cymbal T9	Ride Cymbal T9	
G4	G#4	China Cymbal Aco	ChinaCymbal Real	ChinaCymbal RB	China Cymbal 2	China Cymbal 2	Crash Cymbal 4	
A4	A#4	RideCymbalCupAco	RideCym Cup Real	Ride Cup RB 1	RideCymbal Cup 2	RideCymbal Cup 2	RideCymbal Cup 2	
B4	B#4	Tambourine	Tambourine	Tambourine	Tambourine RX5	Tambourine RX5	Tambourine Hit	
C5	C#5	SplashCymbal Aco	SplashCymbalReal	Splash Cymbal RB	Splash Cymbal	Splash Cymbal 2	Splash Cymbal 2	
D5	D#5	Cowbell	Cowbell	Cowbell	Cowbell T8	Cowbell 1	Cowbell 1	
E5	E#5	CrashCymbalAco 2	CrashCymbalReal2	CrashCymbal RB 2	Crash Cymbal 4	Crash Cymbal 4	Crash Cymbal 1	
F5	F#5	Vibraslap	Vibraslap	Vibraslap	Vibraslap	Cowbell T8	Cowbell T8	
G5	G#5	RideCymbal Aco 2	RideCymbalReal 2	Ride Cup RB 2	Ride Cymbal 3	Ride Cymbal 3	Ride Cymbal 3	
A5	A#5	Bongo H	Bongo H	Bongo H	Conga T8 5	Conga T8 5	Bongo H Open 1 F	
B5	B#5	Bongo L	Bongo L	Bongo L	Conga T8 4	Conga T8 4	Bongo L Open 3 F	
C6	C#6	Conga H Mute	Conga H Mute	Conga H Mute	Conga T8 3	Conga Tip	Conga H Tip	
D6	D#6	Conga H Open	Conga H Open	Conga H Open	Conga T8 2	Conga Open Slap	Conga H SlapOpen	
E6	E#6	Conga L	Conga L	Conga L	Conga T8 1	Conga Open	Conga H Open 2	
F6	F#6	Timbale H	Timbale H	Timbale H	Timbale H	Timbale H	Timbale H	
G6	G#6	Timbale L	Timbale L	Timbale L	Timbale L	Timbale L	Timbale L	
A6	A#6	Agogo H	Agogo H	Agogo H	Glass H	Analog Click	Agogo H	
B6	B#6	Agogo L	Agogo L	Agogo L	Glass L	Conga T8 1	Agogo L	
C7	C#7	Cabasa	Cabasa	Cabasa	Cabasa	Cabasa	Cabasa	
D7	D#7	Maracas	Maracas	Maracas	Maracas T8	Maracas Slur 2	Maracas Slur 2	
E7	E#7	Samba Whistle H *	Samba Whistle H *	Samba Whistle H *	Fx Gun 2 *	Fx Gun 2 *	Vox Drum L	
F7	F#7	Samba Whistle L *	Samba Whistle L *	Samba Whistle L *	Fx Gun 1 *	Fx Gun 1 *	Vox Drum H	
G7	G#7	Guiro Short	Guiro Short	Guiro Short	Analog Shaker H *	Scratch H 3 *	Guiro Short	
A7	A#7	Guiro Long *	Guiro Long *	Guiro Long *	Analog Shaker L *	Scratch Down *	Guiro Long *	
B7	B#7	Claves	Claves	Claves	Claves T8	Hi Q 3	Claves	
C8	C#8	Wood Block H	Wood Block H	Wood Block H	Hi Q 1	Hi Q 1	Wood Block H	
D8	D#8	Wood Block L	Wood Block L	Wood Block L	Hi Q 2	Hi Q 2	Wood Block L	
E8	E#8	Cuica Mute	Cuica Mute	Cuica Mute	Scratch H 2	Scratch H 2	Cuica H	
F8	F#8	Cuica Open	Cuica Open	Cuica Open	Scratch L 2	Scratch L 2	Cuica L	
G8	G#8	Triangle Mute	Triangle Mute	Triangle Mute	Triangle Mute	Triangle Mute	Triangle Mute	
A8	A#8	Triangle Open	Triangle Open	Triangle Open	Triangle Open	Triangle Open	Triangle Open	
B8	B#8	Shaker	Shaker	Shaker	Analog Shaker	Analog Shaker	Analog Shaker	
C9	C#9	Jingle Bells	Jingle Bells	Jingle Bells	Sleigh Bells	Sleigh Bells	Sleigh Bells	
D9	D#9	Wind Chime	Wind Chime	Wind Chime	Wind Chime	Wind Chime	Wind Chime	
E9	E#9				Snare Hip 1	Snare Piccolo	Snare Break Roll	
F9	F#9				Snare Hip 2	Snare T8 7	Noise Burst	
G9	G#9				Snare Hip Gate	SnareRckRollDist	Vox Bell	
A9	A#9				Snare Break 1	Snare Brush Mute	Snare R&B 1	
B9	B#9				Kick Blip	Kick Blip Hard	Vox Alk	
C10	C#10				Snare Fx 1	Snare Jungle 1	Udu High	
D10	D#10				Kick Fx Hammer	Kick Sustain	Filter Kick	

*: Indicates an instrument which requires the Gate Time setting.

Lower Keyboard

Upper Keyboard

		Drum			SFX		
		HipHop Kit	Drum Machine	Break Kit	SFX Kit 1	SFX Kit 2	Live! SFX Kit 1
C-1	C#-1	Surdo Mute	Surdo Mute	Surdo Mute			
D-1	D#-1	Surdo Open	Surdo Open	Surdo Open			
E-1		Hi Q	Hi Q	Hi Q			
F-1	F#-1	Whip Slap	Whip Slap	Whip Slap			
G-1	G#-1	Scratch H	Scratch H	Scratch H			
A-1	A#-1	Scratch L	Scratch L	Scratch L			
B-1		Hi-HatClosedT8 2	Snare Drum&Bass1	Finger Snap			
C0	C#0	Tom T8 3	Kick Break 2	Snare Break 8			
D0	D#0	Hi-Hat Open T8 2	Snare Distortion	Snare Break 9			
E0		Tom T8 6	Kick Tek Power	Hi-HatClosedBrk1 *			
F0	F#0	Crash T8	KickDistortionRM	Hi-HatClosedBrk2 *			
G0	G#0	Triangle Mute	BassDrumHardLong	Kick Break Deep			
A0	A#0	Triangle Open	BassDrumTekPower	Snare Hip			
B0		Wind Chime	Bass Drum Dist 5	Snare Lo-Fi			
C1	C#1	TambourineLight2	Bass Drum Dist 3	Snare Clappy			
D1	D#1	TambourineLight1	Bass Drum Dist 1 *	Snare LdwH Mono			
E1		Kick HipHop 9	BD Drum & Bass 1	Snare Rock Roll *			
F1	F#1	Hi-HatClosed Tek	Bass Drum Blip	Snare Gate 1			
G1	G#1	Kick Gate	BassDrumAnalogSm	Snare Mid			
A1	A#1	Hi-HatOpen Lo-Fi	Kick T8 2	Snare Break Rim			
B1		KickGranCasaOpen	Kick T8 3	Kick Break Heavy			
C2	C#2	Hi-HatReversed&B	Kick T9 HD 3	Snare Hip Rim 4			
D2	D#2	Kick HipHop 1	Kick T9 2	Kick Break 2			
E2		Kick Analog CR	Kick T9 4	Kick Break 1	Cutting Noise 1 *	Phone Call *	Cutting Noise 1 *
F2	F#2	SnareAnalogSmRim	Snare T9 Rim	Snare Hip Rim 1	Cutting Noise 2 *	Door Squeak *	Cutting Noise 2 *
G2	G#2	Snare HipHop 1	Snare T9 1	Snare Break 3		Door Slam *	
A2	A#2	Snare Clappy	Clap T9	Snare Break 1	String Slap *	Scratch Cut *	String Slap *
B2		Snare HipHop 2	Snare T9 4	Snare Break 2		Scratch Split *	
C3	C#3	Floor Tom L	Tom T9 1	Tom Break 1		Wind Chime *	
D3	D#3	Hi-HatClosed Hip	Hi-Hat Closed T9	HHClosedRockSoft		Telephone Ring *	
E3		Low Tom	Tom T9 2	Tom Break 2			
F3	F#3	Hi-Hat Pedal Hip	Hi-Hat Pedal T9	Hi-Hat PedalRock			
G3	G#3	Mid Tom L	Tom T9 3	Tom Break 3			
A3	A#3	Hi-Hat Open Hip	Hi-Hat Open T9	HH HalfOpen Rock			
B3		High Tom	Tom T9 4	Tom Break 4			
C4	C#4	Ride Cymbal 3	Tom T9 5	Tom Break 5			
D4	D#4	Crash Cymbal 3	Crash Cymbal T9	Crash Cymbal 1			
E4		Shaker 2	Conga T8 1	Tom Break 6			
F4	F#4	ScratchBDForward	Ride Cymbal T9	Ride Cymbal 3			
G4	G#4	ScratchBDRReverse	Conga T8 2	China Cymbal 2	Flute Key Click *	CarEngn Ignition *	Flute Key Click *
A4	A#4	Kick HipHop 2	Analog Click	RideCymbal Cup 2		Car Tires Squeal *	
B4		SnareHipHopRim 2	Claves T8 1	Tambourine 1 Hit		Car Passing *	
C5	C#5	HipHop Clap 2	Maracas T8	Splash Cymbal 2		Car Crash *	
D5	D#5	HipHop Snap 1	TambourineAna CR	Cowbell 1		Siren *	
E5		Snare HipHop 3	Analog Shaker	Crash Cymbal 2		Train *	
F5	F#5	Electric Clap 2	Cowbell T8	Cowbell RX11		Jet Plane *	
G5	G#5	Kick Hip Deep	CowbellAnalog CR	Ride Cymbal 2		Starship *	
A5	A#5	Kick HipHop 3	Snare T8 1	Bongo H		Burst *	
B5		SnareHipHopRim 3	Snare T8 2	Bongo L		Roller Coaster *	
C6	C#6	Snare HipHop 5	Snare T8 3	Conga H Tip		Submarine *	
D6	D#6	Electric Clap 1	Snare Analog CR	Conga H OpenSlap			
E6		Handbell H	Snare Jungle 1	Conga H Open			
F6	F#6	Kick HipHop 4	Snare Drum&Bass2	Bongo 2 H			
G6	G#6	HipHop Clap 3	Snare Hip 1	Bongo 2 L			
A6	A#6	HipHop Snap 2	Snare R&B 1	Conga Open			
B6		SnareHipHopRim 5	Snare R&B 2	Agogo L	Shower *	Laugh *	Shower 2 *
C7	C#7	HipHop flex 1	Snare Hip 1	Cabasa	Thunder *	Scream *	Thunder 2 *
D7	D#7	HipHop flex 2	Snare Wood	Maracas Slur	Wind *	Punch *	Wind 2 *
E7		Shaker 2	Snare Timbre	Timbale H	Stream *	Heart Beat *	Stream 2 *
F7	F#7	Kick HipHop 5	Hi-HatClosedT8 1	Timbale L	Bubble *	Foot Steps *	Bubble 2 *
G7	G#7	SnareHipHopRim 4	Hi-Hat Open T8 1	Scratch H 3 *	Feed *		Feed *
A7	A#7	Snare HipHop 6	Hi-HatClosedT8 2	Scratch Down *			
B7		Snare HipHop 11	Hi-Hat Open T8 2	Claves			
C8	C#8	Kick HipHop 10	Hi-Hat Pedal Aco	Wood Block H			
D8	D#8	Snare HipHop 7	Hi-HatClosed Aco	Wood Block L			
E8		HipHop Clap 5	Hi-Hat Open Aco	Scratch H 2			
F8	F#8	Conga H Tip	Hi-HatClosedLoFi	Scratch L 2			
G8	G#8	Conga H Heel	Hi-HatOpen Lo-Fi	Triangle Mute			
A8	A#8	Conga H Open	Hi-HatClosed Syn	Triangle Open			
B8		Conga L Open 1	Hi-Hat Open Syn	Kick Break 3			
C9	C#9	Conga L Open 2	Analog Shaker 1	Kick Break 4			
D9	D#9	Kick HipHop 8	Tambourine FX5 2	Kick Break 5 *	Dog *	Machine Gun *	Dog *
E9		HipHop Clap 6	Tambourine 1 Hit	Kick Break 6	Horse *	Laser Gun *	Horse *
F9	F#9	Snare T8 1	Electric Cowbell	Kick Break 7	Bird Tweet *	Explosion *	Bird Tweet *
G9	G#9	Snare T8 1 H	Conga T8 3	Hi-HatClosedBrk3		Firework *	
A9	A#9	HipHop Clap 7	ElectricTriangle	Snare Break 4			
B9		Tom T8 1	Claves T8 2	Snare Break 5			
C10	C#10	Hi-HatClosedT8 2	Analog Shaker 2	Snare Break 6	Ghost *		Ghost *
D10	D#10	Tom T8 2	Electric Clap 1	Snare Break 7	Maou *		Maou *

*: Indicates an instrument which requires the Gate Time setting.

10

Rhythm Program

		SFX						
		Live! SFX Kit 2	Noise Kit	VocalEffectsKit	GospelAdLibs	Wonderland Kit	PopLatin Kit	
Lower Keyboard	C-1							
	D-1	C#-1					Cajon Low	
	E-1	D#-1					Cajon Slap	
	F-1						Cajon Tip	
	G-1	F#-1					Claves High	
	A-1						Claves Low	
	B-1	G#-1					Hand Clap	
	C0							
	D0	C#0					Finger Snap	
	E0	D#0					Castanet	
	F0	F#0					Conga H Tip	
	G0						Conga H Heel	
	A0	G#0					Laser Beam	
	B0	A#0					Conga H Open	
	C1		Phone Call *	White Noise *	Male Ha 1 *		Laser Shot *	Conga H Mute
	D1	C#1	Door Squeak 2 *	Pink Noise *	Female Ha 1 *		Water Phone *	Conga H SlapOpen
	E1	D#1	Door Slam 2 *	WhiteNoiseDown 1 *	Male Ha 2 *		Bubble	Conga H Slap
	F1	F#1	Scratch Cut *	PinkNoise Down 1 *	Male Ha 3 *		Puddle	Conga H SlapMute
	G1		Scratch Split *	WhiteNoiseDown 2 *	Male Bh 1 *		Thunder *	Conga L Tip
	A1	G#1	Wind Chime *	PinkNoise Down 2 *	Female Bh 1 *		Shower *	Conga L Heel
B1	A#1	Telephone Ring 2 *	White Noise Up 2 *	Male Kh 1 *		Beach *	Conga L Open	
C2			White Noise Up 1 *	Female Kh 1 *		Stream *	Conga L Mute	
D2	C#2		Pink Noise Up *	Male Ph 1 *		Footstep	Conga L SlapOpen	
E2	D#2		WhiteNoiseUp Rel *	Female Ph 1 *		Door Squeak	Conga L Slap	
F2	F#2		PinkNoiseUp Rel *	Male Th 1 *		Door Slam	Conga L Slide *	
G2	G#2		WhiteNoiseUp LFO *	Female Th 1 *		Door Slam	Conga L Slide *	
A2	A#2		PinkNoiseUp LFO *	Male Bh 2 *	C'mon *	Bass Drum	Bongo H Open 1 f	
B2				Female Bh 2 *	Hoo! *	Gran Cassa	Bongo H Open 3 f	
C3	C#3			Male Kh 2 *	Aha! *	Tom 2	Bongo L Rim	
D3	D#3			Female Kh 2 *	Oh Yeah *	Tom 1	Bongo H Tip	
E3	F#3			Male Ph 2 *	Yayayayah *	Snare	Bongo H Heel	
F3		CarEngn Ignition *		Female Ph 2 *	Put Your Hands... *	Snare Roll *	Bongo H Slap	
G3	G#3	Car Tires Squeal *		Male Th 2 *	C'mon Now *	Hi-Hat Closed	Bongo L Open 1 f	
A3	A#3	Car Passing *		Female Th 2 *	Heeey *	Cymbal	Bongo L Open 3 f	
B3		Car Crash *		Male Ph 2 *	Everybody Now *	Hi-Hat Open	Bongo L Rim	
C4	C#4	Siren 2 *		Male Ha 4 *	ClapYourHands... *	Tambourine	Bongo L Tip	
D4	D#4	Train 2 *		Female Ha 2 *	WithAllYourSoul *	Finger Snap	Bongo L Heel	
E4	F#4	Jet Plane 2 *		Male Ha 5 *	Stand Up On... *	Castanet	Bongo L Slap	
F4		Starship *		Male Ha 6 *	Uhh Yeah *	Triangle Mute	Timbale L	
G4	G#4	Burst *		Male Bh 3 *	Aaah *	Wood Block L		
A4	A#4			Female Bh 3 *	Come On! *	Triangle Open		
B4				Male Kh 3 *	Yeah! *	Wood Block H		
C5	C#5	Roller Coaster *		Female Bh 3 *	Aaah *			
D5	D#5	Submarine *		Male Kh 3 *	Come On! *			
E5				Female Kh 3 *	Yeah! *			
F5	F#5			Male Ph 3 *	Alright Now! *			
G5				Female Ph 3 *	One *			
				Male Th 3 *	Two *			
				Female Th 3 *	Three *			
		Laugh *		Male Bh 4 *	Four *			
		Scream 2 *		Female Bh 4 *	One! *			
		Punch 2 *		Male Kh 4 *	Two! *			
		Heart Beat *		Female Kh 4 *	Three! *			
		Foot Steps 2 *		Male Ph 4 *	Four! *			
				Female Ph 4 *	Five! *			
				Male Th 4 *	Six! *			
				Female Th 4 *	Seven! *			
					Eight! *			
					Nine! *			
					Ten! *			
					Eleven! *			
					Twelve! *			
					Thirteen! *			
					Fourteen! *			
					Fifteen! *			
					Sixteen! *			
					Seventeen! *			
					Eighteen! *			
					Nineteen! *			
					Twenty! *			
					Twenty One! *			
					Twenty Two! *			
					Twenty Three! *			
					Twenty Four! *			
					Twenty Five! *			
					Twenty Six! *			
					Twenty Seven! *			
					Twenty Eight! *			
					Twenty Nine! *			
					Thirty! *			
					Thirty One! *			
					Thirty Two! *			
					Thirty Three! *			
					Thirty Four! *			
					Thirty Five! *			
					Thirty Six! *			
					Thirty Seven! *			
					Thirty Eight! *			
					Thirty Nine! *			
					Forty! *			
					Forty One! *			
					Forty Two! *			
					Forty Three! *			
					Forty Four! *			
					Forty Five! *			
					Forty Six! *			
					Forty Seven! *			
					Forty Eight! *			
					Forty Nine! *			
					Fifty! *			
					Fifty One! *			
					Fifty Two! *			
					Fifty Three! *			
					Fifty Four! *			
					Fifty Five! *			
					Fifty Six! *			
					Fifty Seven! *			
					Fifty Eight! *			
					Fifty Nine! *			
					Sixty! *			
					Sixty One! *			
					Sixty Two! *			
					Sixty Three! *			
					Sixty Four! *			
					Sixty Five! *			
					Sixty Six! *			
					Sixty Seven! *			
					Sixty Eight! *			
					Sixty Nine! *			
					Seventy! *			
					Seventy One! *			
					Seventy Two! *			
					Seventy Three! *			
					Seventy Four! *			
					Seventy Five! *			
					Seventy Six! *			
					Seventy Seven! *			
					Seventy Eight! *			
					Seventy Nine! *			
					Eighty! *			
					Eighty One! *			
					Eighty Two! *			
					Eighty Three! *			
					Eighty Four! *			
					Eighty Five! *			
					Eighty Six! *			
					Eighty Seven! *			
					Eighty Eight! *			
					Eighty Nine! *			
					Ninety! *			
					Ninety One! *			
					Ninety Two! *			
					Ninety Three! *			
					Ninety Four! *			
					Ninety Five! *			
					Ninety Six! *			
					Ninety Seven! *			
					Ninety Eight! *			
					Ninety Nine! *			
					One Hundred! *			
					One Hundred One! *			
					One Hundred Two! *			
					One Hundred Three! *			
					One Hundred Four! *			
					One Hundred Five! *			
					One Hundred Six! *			
					One Hundred Seven! *			
					One Hundred Eight! *			
					One Hundred Nine! *			
					One Hundred Ten! *			
					One Hundred Eleven! *			
					One Hundred Twelve! *			
					One Hundred Thirteen! *			
					One Hundred Fourteen! *			
					One Hundred Fifteen! *			
					One Hundred Sixteen! *			
					One Hundred Seventeen! *			
					One Hundred Eighteen! *			
					One Hundred Nineteen! *			
					One Hundred Twenty! *			
					One Hundred Twenty One! *			
					One Hundred Twenty Two! *			
					One Hundred Twenty Three! *			
					One Hundred Twenty Four! *			
					One Hundred Twenty Five! *			
					One Hundred Twenty Six! *			
					One Hundred Twenty Seven! *			
					One Hundred Twenty Eight! *			
					One Hundred Twenty Nine! *			
					One Hundred Thirty! *			
					One Hundred Thirty One! *			
					One Hundred Thirty Two! *			
					One Hundred Thirty Three! *			
					One Hundred Thirty Four! *			
					One Hundred Thirty Five! *			
					One Hundred Thirty Six! *			
					One Hundred Thirty Seven! *			
					One Hundred Thirty Eight! *			
					One Hundred Thirty Nine! *			
					One Hundred Forty! *			
					One Hundred Forty One! *			
					One Hundred Forty Two! *			
					One Hundred Forty Three! *			
					One Hundred Forty Four! *			
					One Hundred Forty Five! *			
					One Hundred Forty Six! *			
					One Hundred Forty Seven! *			
					One Hundred Forty Eight! *			
					One Hundred Forty Nine! *			
					One Hundred Fifty! *			
					One Hundred Fifty One! *			
					One Hundred Fifty Two! *			
					One Hundred Fifty Three! *			
					One Hundred Fifty Four! *			
					One Hundred Fifty Five! *			
					One Hundred Fifty Six! *			
					One Hundred Fifty Seven! *			
					One Hundred Fifty Eight! *			
					One Hundred Fifty Nine! *			
					One Hundred Sixty! *			
					One Hundred Sixty One! *			
					One Hundred Sixty Two! *			
					One Hundred Sixty Three! *			
					One Hundred Sixty Four! *			
					One Hundred Sixty Five! *			
					One Hundred Sixty Six! *			
					One Hundred Sixty Seven! *			
					One Hundred Sixty Eight! *			
					One Hundred Sixty Nine! *			
					One Hundred Seventy! *			
					One Hundred Seventy One! *			
					One Hundred Seventy Two! *			
					One Hundred Seventy Three! *			
					One Hundred Seventy Four! *			
					One Hundred Seventy Five! *			
					One Hundred Seventy Six! *			
					One Hundred Seventy Seven! *			
					One Hundred Seventy Eight! *			
					One Hundred Seventy Nine! *			
					One Hundred Eighty! *			
					One Hundred Eighty One! *			
					One Hundred Eighty Two! *			
					One Hundred Eighty Three! *			
					One Hundred Eighty Four! *			
					One Hundred Eighty Five! *			
					One Hundred Eighty Six! *			
					One Hundred Eighty Seven! *			
					One Hundred Eighty Eight! *			
					One Hundred Eighty Nine! *			
					One Hundred Ninety! *			
					One Hundred Ninety One! *			
					One Hundred Ninety Two! *			
					One Hundred Ninety Three! *			
					One Hundred Ninety Four! *			
					One Hundred Ninety Five! *			
					One Hundred Ninety Six! *			
					One Hundred Ninety Seven! *			
					One Hundred Ninety Eight! *			
					One Hundred Ninety Nine! *			
					Two Hundred! *			
					Two Hundred One! *			
					Two Hundred Two! *			
					Two Hundred Three! *			
					Two Hundred Four! *			
					Two Hundred Five! *			
					Two Hundred Six! *			
					Two Hundred Seven! *			
					Two Hundred Eight! *			
					Two Hundred Nine! *			
					Two Hundred Ten! *			
					Two Hundred Eleven! *			
					Two Hundred Twelve! *			
					Two Hundred Thirteen! *			
					Two Hundred Fourteen! *			
					Two Hundred Fifteen! *			
					Two Hundred Sixteen! *			
					Two Hundred Seventeen! *			
					Two Hundred Eighteen! *			
					Two Hundred Nineteen! *			
					Two Hundred Twenty! *			
					Two Hundred Twenty One! *			
					Two Hundred Twenty Two! *			
					Two Hundred Twenty Three! *			
				</				

		SFX				
		Cuban Kit	Arabic Kit	Turkish Kit	China Kit	OrchestraPerc
C-1	C#-1			Asma Davul L		Symphonic Gong 1
D-1	D#-1			Asma Davul R		Symphonic Gong L *
E-1				Asma Davul Side		Symphonic Gong 2
F-1	F#-1			Asma Davul Both		Timpani E
G-1	G#-1			KoltukDavul Flam		Timpani F
A-1	A#-1			KoltukDavul Teke		Timpani F#
B-1				Koltuk Davul Tek		Timpani G
C0	C#0			Koltuk Davul Dum		Timpani G#
D0	D#0			Bendir Teke Flam		Timpani A
E0		Conga H Tip		Bendir Teke Dead		Timpani A#
F0	F#0	Conga H Heel		Bendir Tek Dead	Da Cha 2	Timpani B
G0	G#0	Conga H Open	Nakarazan Dom	Bendir Teke	Da Gu mp	Timpani C
A0	A#0	Conga H Mute	Cabasa	Bendir Tek	Da Gu Rim	Timpani C#
B0		Conga H Slap/Open	Nakarazan Edge	Bendir Slap	Da Gu f	Timpani D
C1	C#1	Conga H Slap	Hager Dom	Bendir Dum	Da Gu Hand	Timpani D#
D1	D#1	Conga H SlapMute	Hager Edge	Zil Right Close	Da Gu Roll *	Timpani High E
E1		Conga L Tip	Bongo H	Zil Right Open	Pai Gu 4	Gran Cassa Hard
F1	F#1	Conga L Heel	Bongo L	Zil Left Close	Pai Gu 4 High	Gran Cassa Soft
G1	G#1	Conga L Open	Conga H Mute	Zil Left Open	Pai Gu 3	Gran Cassa Hit
A1	A#1	Conga L Mute	Conga H Open	Tef Teke Flam	Pai Gu 3 High	Gran Cassa Cresc
B1		Conga L Slap/Open	Conga L	Tef Tek Mute	Pai Gu 2	ConcertSnareDrum
C2	C#2	Conga L Slap	Zagrouda H	Tef Teke Damped	Pai Gu 2 High	Snare Roll *
D2	D#2	Conga L Slide *	Zagrouda L *	TefTekMuteMedium	Pai Gu 1	Snare Drum Light
E2		Bongo H Open 1 f	Kick Soft	Tef Dum Mute	Luo High 1	Snare Ensemble
F2	F#2	Bongo H Open 3 f	Side Stick	Tef Cymbal	Gong Batter	Sus Cym 1 Roll S *
G2	G#2	Bongo H Rim	Snare Soft	Tef Cymbal Mute	Jin Luo	Sus Cymbal 1
A2	A#2	Bongo H Tip	Arabic Hand Clap	Tef Tremolo *	Luo High 2	Sus Cym 2 Roll L *
B2		Bongo H Heel	Snare Drum	Tef Shake 1	Luo Mid-Low	Sus Cymbal 2
C3	C#3	Bongo H Slap	Floor Tom L	Tef Shake 2	Luo	Concert Tom 1
D3	D#3	Bongo L Open 1 f	Hi-Hat Closed	Tef Tek Flam	Jin Luo Low	OrchCymbal 1 ckd
E3		Bongo L Open 3 f	Floor Tom H	Tef Full Open	Da Cha 1	Concert Tom 2
F3	F#3	Bongo L Rim	Hi-Hat Pedal	Tef Teke OpShort	Da Cha Effect	Orch Cymbal 1
G3	G#3	Bongo L Tip	Low Tom	Tef Tek Op Short	Zhongcha	Concert Tom 3
A3	A#3	Bongo L Heel	Hi-Hat Open	Tef Tek Open	Xiaocha Effect	Orch Cymbal 2
B3		Bongo L Slap	Mid Tom L	Tef Dum Open	Xiaocha	Concert Tom 4
C4	C#4	Timbale L	Mid Tom H	Hollo FingerDead	Mang Luo Low	Concert Tom 5
D4	D#4		Crash Cymbal 1	Hollo Slap	Mang Luo Mid	Finger Cymbal
E4			High Tom	Hollo Dum	Qing	Gong
F4	F#4		Ride Cymbal 1	Kasik	Finger Bell	Ride Cymbal Tip
G4	G#4		Crash Cymbal 2	Kasik Flam	Luo Big	China Cymbal
A4	A#4	Paila L	Duhulla Dom	BDarbuka TekDead	Muyu Low	Ride Cymbal Cup
B4		Timbale H	Tambourine	BDarbuka TekFlam	Muyu Mid-Low	Tambourine
C5	C#5		Duhulla Tak	BassDarbuka Teke	Muyu Mid	Splash Cymbal
D5	D#5		Cowbell	BDarbukaTekeFin1	Muyu High	Cowbell
E5			Duhulla Sak	BDarbukaTekeFin2	Nanbangzi Roll *	Jingle Ring
F5	F#5		Claves	Bass Darbuka Tek	Nanbangzi	Castanet Roll *
G5			Paila H	BassDarbukaSlap1	Bangu	Table Castanet
A5	A#5		Cowbell Top	BassDarbukaSlap2	Ban	Bongo H Stick
B5				Bass Darbuka Dum	Bangu Roll *	Bongo L Stick
C6	C#6			Katemb Tak	DarbukaRollClose *	Conga H Stick
D6	D#6			Katemb Sak	DarbukaRollOpen *	ChineseOperaVo 2 *
E6				Katemb Tak	DarbukaRollOpen *	ChineseOperaVo 3 *
F6	F#6			Guiro Short	Doff Tak	DarbukaTekeFlamD
G6	G#6			Guiro Long *	Tabla Dom	Darbuka Tek Dead
A6	A#6				Tabla Tak 1	DarbukaTekDamped
B6					Tabla Tik	Darbuka TekeFlam
C7	C#7				Tabla Tak 2	Darbuka Teke
D7	D#7				Tabla Sak	DarbukaTekeFin 1
E7					Tabla Roll Edge *	DarbukaTekeFin 2
F7	F#7				Tabla Flam	Darbuka Tek 1
G7	G#7				Tabla Flam	Darbuka Tek 1
A7	A#7				Maracas	Sagat 1
B7					Shaker	Tabel Dom
C8	C#8				Cabasa	Sagat 3
D8	D#8					Tabel Tak
E8						Sagat 2
F8	F#8					Rik Dom
G8	G#8					Rik Tak 2
A8	A#8					Rik Finger 1
B8						Rik Tak 1
C9	C#9					Rik Finger 2
D9	D#9					Rik BrassTremolo *
E9						Rik Sak
F9	F#9					Rik Tik
G9	G#9					

*: Indicates an instrument which requires the Gate Time setting.

Rhythm Sequence Program

With the Rhythm Sequence Program function, you can string together any of the Electone's existing rhythms and the rhythms of your own creation together to make complete rhythm compositions.

You can save four rhythm compositions (each containing up to 140 bars) to the Sequence buttons on the panel for future recall. Two or more rhythm compositions can be played back in succession, letting you divide a Song into parts and play back the rhythm data as desired. Here are a couple of example applications:

- When you want to play more than two Songs in a medley, save the rhythm composition for each Song to a separate sequence button. You can then recall each desired Song by simply pressing the corresponding sequence button to which the Song is saved.
- When you want to practice a Song in separate sections (for example, separately practicing the verse, chorus and bridge), divide the Song into the relevant parts. For example, save the intro part to the [SEQ. 1] button, the main chorus part to the [SEQ. 2] button, the ending to the [SEQ. 3] button, and so on. Then, recall the desired part simply by pressing the appropriate sequence button. You can also play through a Song by recalling all the parts in sequence.

Selecting a sequence

There are two ways to program a Rhythm Sequence: creating your own sequence from scratch, or copying and editing an existing sequence that is similar to the sequence you want to create.

Reference pages

- Programming a Sequence (page 173)
- Copying a Rhythm Sequence (page 177)

1 Press the [SEQUENCE] button in the DISPLAY SELECT section.

The MENU Page of the Sequence display appears.

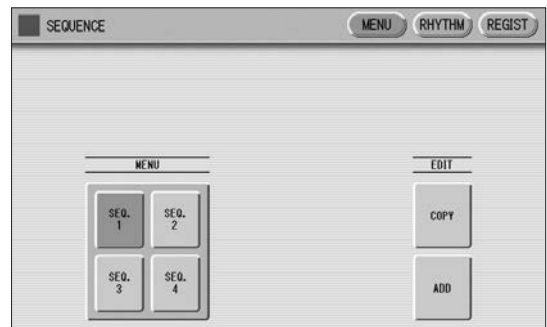
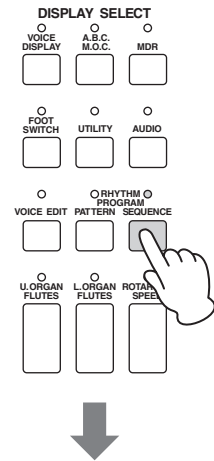

Any rhythm currently playing will automatically be stopped when you call up the Rhythm Sequence Program function.

2 Press one of the Sequence buttons ([SEQ. 1] – [SEQ. 4]) on the left half in the display to select the Rhythm Sequence number you want to edit.

The lamp of the selected numbered sequence button in the Rhythm section lights.

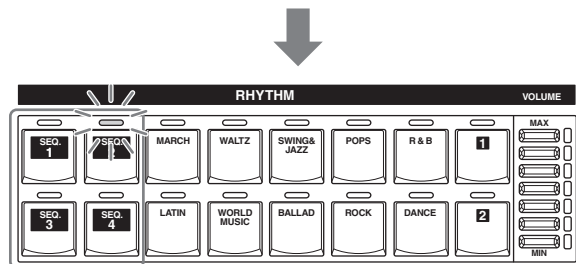
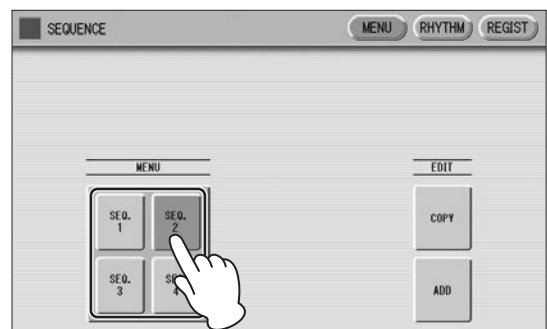

Instead of pressing the Sequence button on the display, you can press one of the sequence buttons in the Rhythm section on the panel to select the sequence number.

This selects the Sequence number, to which a rhythm composition can be saved.

If you want to edit an existing rhythm composition, refer to “Copying a Rhythm Sequence” on page 177. If you want to program a Rhythm Sequence from scratch, refer to “Programming a Sequence” below.

Programming a sequence

- 1 Press the [RHYTHM] button at the top right of the display to call up the RHYTHM Page.
- 2 Press the rhythm button corresponding to the rhythm you want to enter to the sequence. If you press User button [1] or [2], you can select a rhythm of your own creation (User rhythm).

The rhythm menu of the selected rhythm button is displayed.

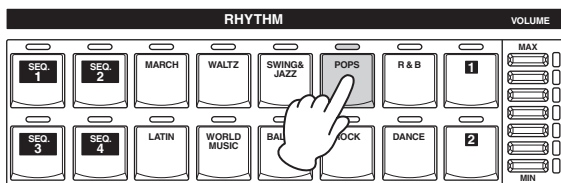

- 3 Select the desired rhythm from the displayed rhythm menu.



- 4 Select a rhythm section (Main A – D, Fill in A – D, Intro 1 – 3, Ending 1 – 3, or Break) by pressing one of the rhythm control buttons on the panel.

The selected rhythm and section appears at the top of the display.

NOTE

- When entering an Intro section, you can confirm the number of measures at the top of the display.
- When you press the ENDING [1] button while the Main section is playing back, a fill in pattern will be called up before the Ending 1 pattern. In the Rhythm Sequence program, however, a fill in pattern is not called up when Ending 1 is entered to the Sequence.

- 5 Press the [SET] button in the display.

One measure of the selected rhythm is entered and its name is displayed as a box in the rhythm row on the display. When the rhythm is entered, the cursor (colored orange) will automatically move one step to the right. A maximum of 140 measures can be entered to a single sequence. When you select an ending pattern and press the [SET] button, an entire ending pattern (more than one measure) is entered. You cannot enter a rhythm after an ending pattern.

- 6 Repeat steps 2 through 5 above to enter the rhythm and create your own rhythm composition.

Turning the power off before quitting or closing the Rhythm Sequence Program erases any sequences you have made. Before turning the power off, quit the Rhythm Sequence Program (page 176).

Auditioning a sequence

You can play a sequence you are editing at any time to audition the changes.

- 1 Move the cursor to the desired position for playback.

Move the cursor by using the Data Control dial, or the POSITION buttons on the display.

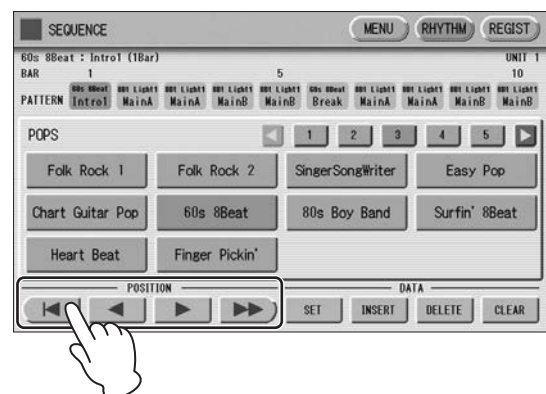

2 Press the rhythm [START] button on the panel.

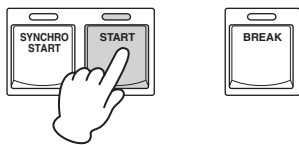

The Sequence plays back. Pressing the [START] button again stops playback.

Editing an existing Rhythm Sequence

You can insert a new rhythm between the rhythms you have already entered, or delete the entered rhythm from the sequence.

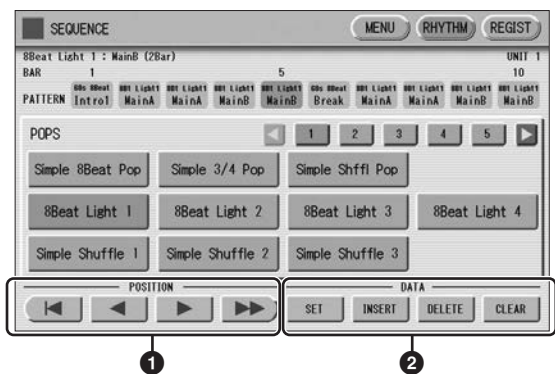

1 POSITION

These are cursor controls for moving the cursor (colored orange) along the rhythm row in the display.

- Moves the cursor to the first position.
- Moves the cursor one step to the left.
- Moves the cursor one step to the right.
- Moves the cursor five steps to the right.

2 DATA

These are data controls for entering rhythms and deleting existing rhythms in the rhythm row.

NOTE

When you insert an ending pattern into the editing sequence, any existing rhythm data that follows an Ending pattern is automatically deleted.

SET

For initially entering a rhythm to an empty position in the rhythm row, or for replacing a pattern at the cursor position. Pressing the [SET] button enters the rhythm selected from the rhythm menu to the cursor position.

This operation is not available between measures of an ending pattern.

INSERT

For inserting a rhythm before the current cursor position. The new rhythm is entered just before the cursor position and all other rhythms to the right of the cursor are moved to accommodate the new number. This operation is not available between measures of an ending pattern.

Additional rhythms cannot be entered beyond the Rhythm sequence function's capacity of 140. If the Insert operation results in the rhythm number going over the capacity, a "Data Full" message appears and the operation cannot be executed.

DELETE

For deleting a rhythm at the current cursor position. When the ending pattern is selected, pressing the [DELETE] button deletes the entire ending pattern (more than one measure).

CLEAR

For erasing all patterns entered to the selected sequence.

After selecting [CLEAR], a message appears prompting confirmation of the operation. Select [CLEAR] to clear the currently selected Rhythm Sequence, or select [CANCEL] to abort the operation and return to the previous display.

Programming a Registration Sequence

The Registration Sequence feature allows you to have desired Registrations automatically called up in sequence, when playing a Rhythm Sequence. It lets you program the timing (measure/beat/clock) at which the Registration is changed. You can also program the Next Unit function in Registration Sequence.

A Registration Sequence is saved as a part of the corresponding Rhythm Sequence.

With this feature, you can have the sounds of the instrument change as desired automatically to match the Rhythm Sequence playback.

1 Press the [REGIST] button at the top right in the display to call up the Registration Sequence display.

NOTE

If you are loading a Registration while a rhythm is playing, the sequence data and User rhythms in the Registration data cannot be loaded.

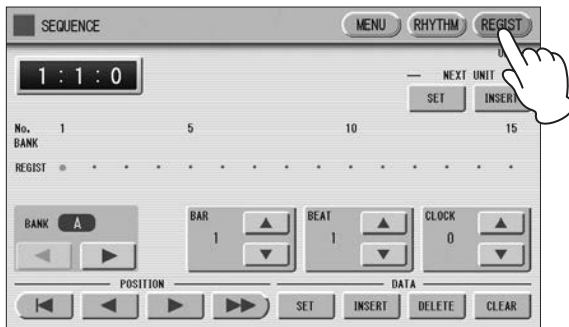

The Registration Sequence is programmed from this display. The entered Registration number is shown along the Registration row in the middle of the display.

- 2 Select a Bank, then press the desired numbered button in the Registration Memory section.
- 3 Using the  buttons in the display or the Data Control dial, set the Measure/Beat/Clock position at which you want to change the Registration (1 beat = 96 clocks).

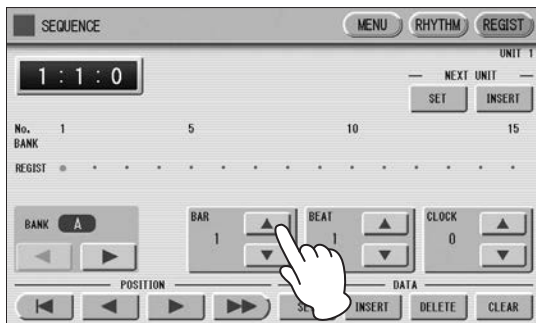



When using the Data Control dial, first press the number you wish to change in the display, then turn the dial.

- 4 Press the DATA [SET] button in the display.
The Registration number appears in the display (in the timing order), indicating that the Registration is entered. Up to 140 Registrations can be entered. If some Registration numbers are entered to the same Measure/Beat/Clock, the last entered one takes priority.
- 5 Repeat steps 2 through 4 above to set the Registration Sequence.

Entering Next Unit:

When you program the Next Unit function in Registration Sequence, the next registration data in current Song can be loaded automatically just by playing the Rhythm Sequence.

- 1 Using the  buttons in the display or the Data Control dial, set the Measure/Beat/Clock position at which you want to enter the Next Unit (1 beat = 96 clocks).
- 2 Press the NEXT UNIT [INSERT] button in the display.

The Next Unit mark  appears at the timing point you set in step 1, indicating that the Next Unit is entered.

Next Unit Loading Time

- Loading a Next Unit may take a few seconds (the time may differ depending on the size of the data to be loaded).
- Next Unit data can be loaded by two ways: using the right footswitch and programming Next Unit in the Registration Sequence. Loading time is the same regardless of which way you load the Next Unit data.

Editing an existing Registration Sequence

You can move or delete the entered Registration Sequence (Registration number or Next Unit data) from the sequence.

To move an entry:

- 1 Using the POSITION buttons, move the cursor and select the data (Registration number or Next Unit) you want to move.
- 2 Change the position by pressing the Bar/Beat/Clock buttons in the display.
- 3 To move the Registration number timing, press the DATA [SET] button. To move the Next Unit timing, press the NEXT UNIT [SET] button.

The position of the Registration number or Next Unit is changed and displayed in the proper order.

To erase an entry:

- 1 Using the **POSITION** buttons, move the cursor and select the data (**Registration number or Next Unit**) you want to delete.
- 2 Press the **[DELETE]** button to delete the data.

Quitting the Rhythm Sequence Program

You can quit the Rhythm Sequence Program from any of its display pages. When you quit, the sequence you have made will be automatically saved.

To quit the Rhythm Sequence Program:

Press the **[SEQUENCE]** button on the panel.
The Voice Display appears, indicating that the Rhythm Sequence Program is closed.

NOTICE

When quitting the Rhythm Sequence Program, the square at the top left of the display turns light blue for a few seconds, indicating that the sequence is currently being saved. Do not turn the power off while the sequence is being saved.

Playing Rhythm Sequences

To play any of the Rhythm Sequences you have created:

- 1 Press the appropriate **Sequence button ([SEQ. 1] – [SEQ. 4])** on the panel.
The SEQ button's lamp lights.

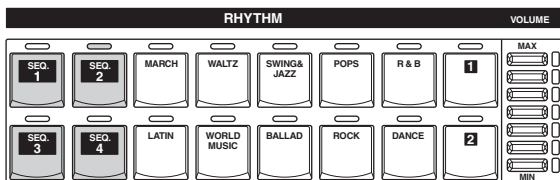

- 2 Press the rhythm **[START]** button.
The rhythm in the selected sequence starts playback. When one of the four Rhythm Sequences is playing, each programmed rhythm that plays is indicated by the lit LED of the Rhythm buttons.

The Registration Memory also changes with Rhythm Sequence playback, if the sequence includes a Registration Sequence.

Rhythm playback automatically stops when the sequence reaches its end.

If you've stopped rhythm playback in the middle of the sequence, press the **[START]** button again to resume playback.

Playing all sequences in order

You can also have up to all four Rhythm Sequences automatically play in order, one after another.

- 1 Press the desired **Sequence buttons, making sure that all their LEDs are lit.**
- 2 Press the rhythm **[START]** button.

The Rhythm Sequences start from the lowest number and play in order automatically to the highest number. (For example, if you press Sequence buttons 4, 2 and 1 in that order, the sequences will be played back not in the order you pressed them, but in their numeric order: 1, 2, then 4.) This function effectively allows you to make a long Rhythm Sequence that exceeds the 140-pattern memory limit of a single sequence.

Pressing one of the SEQ. buttons while a Rhythm Sequence is playing automatically cancels the pressed sequence, and its LED turns off. You cannot cancel a sequence that is currently playing. The SEQ. lamp goes out when the sequence assigned to it is finished playing.

To start a sequence using the Left Footswitch:

You can start or stop the Rhythm Sequence playback using the left footswitch.

- 1 Press the desired **Sequence buttons, making sure that all their LEDs are lit.**
- 2 Press the **[FOOT SWITCH]** button on the panel to call up the **Footswitch display, LEFT Page.**

3 Set the control mode of the Footswitch to RHYTHM STOP.

(See page 178 for information about the Footswitch settings.)

4 Press the Left Footswitch with your right foot to turn the sequence on.

Pressing the Left Footswitch again in the middle of the sequence playback cancels the Rhythm Sequence.

When you are playing a Rhythm Sequence that is made up of several sequences (SEQ. buttons), pressing the Left footswitch turns off the currently playing Rhythm Sequence, and pressing it again starts the next sequence.

Copying a Rhythm Sequence

You can copy a Rhythm Sequence stored on a sequence button to another button. You can also add a Rhythm Sequence to the end of another Rhythm Sequence.

1 Press the EDIT [COPY] or [ADD] button in the Sequence Menu page.

The Copy From or Add From display appears.

NOTE

If you add a Rhythm Sequence to another Rhythm Sequence that has an ending at the end, the section will automatically change to MAIN A and the new sequence will be added after the MAIN A part.

2 Select the number of the desired Rhythm Sequence program to which you want to copy or to which you want to add.

A message appears prompting confirmation of operation.

3 Press the [COPY] or [ADD] button to copy or add the Rhythm Sequence.

Press [CANCEL] to abort the operation.

4 If necessary, edit the sequence.

Refer to the section “Editing an existing Rhythm Sequence” on page 174 and/or “Editing an existing Registration Sequence” on page 175.

Saving Rhythm Pattern and Rhythm Sequence Data to a USB Flash Drive

You can save your own rhythm patterns (created in the Rhythm Pattern Program) and Rhythm Sequences (created in the Rhythm Sequence Program) to a USB flash drive. Refer to the section “Saving Registrations and Other Data to a Unit” on page 118 for instructions.

When loading your original Rhythm data from a USB flash drive back to the Electone, be sure to stop the rhythm if it is playing. Loading cannot be executed when a rhythm is running.

Footswitches, Knee Lever and Expression Pedals

These leg- and foot-operated controls allow you to execute various performance functions and switch the effect on/off, without taking your hands from the keyboard.

Footswitches

The Electone has two Footswitches on the main expression pedal. The Right Footswitch is used for the Registration Shift function. The Left Footswitch can be set to control one of the following functions: Rhythm, Glide, and Rotary speaker.

See page 99 for the details of the Registration Shift function or Right Footswitch.

The explanation of the Left Footswitch is given here.

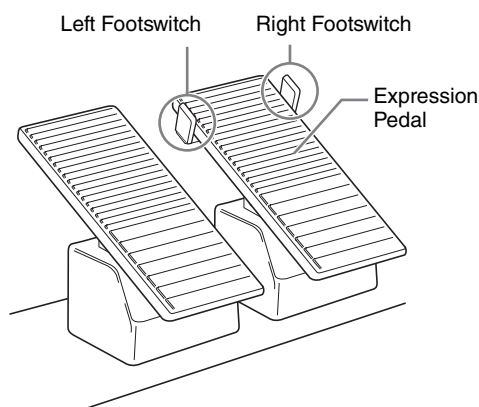

- 1 Press the [FOOT SWITCH] button.
- 2 Press the [LEFT] button at the top right of the display to call up the LEFT Page.

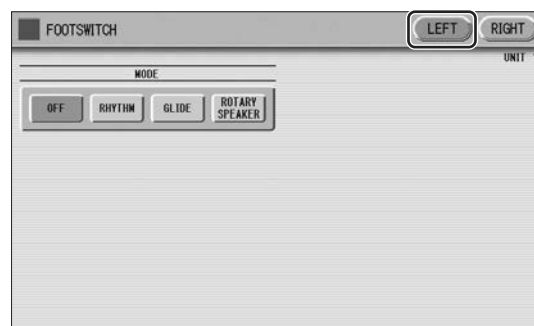
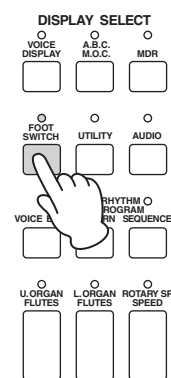

In this display, you can assign the control function to the Left Footswitch: Rhythm, Glide, and Rotary Speaker.

If you choose OFF here, the Left Footswitch will not control any function.

NOTE

When the Next Page function of the score display is assigned to the left foot switch, and if rhythm, glide and/or rotary speaker are assigned to the left foot switch as well, pressing the foot switch performs both the assigned function and the Next Page function. For details on the Next Page function, refer to page 125.

Controlling the Rhythm

You can control the rhythm start/stop or switch the rhythm sections by using the Left Footswitch.

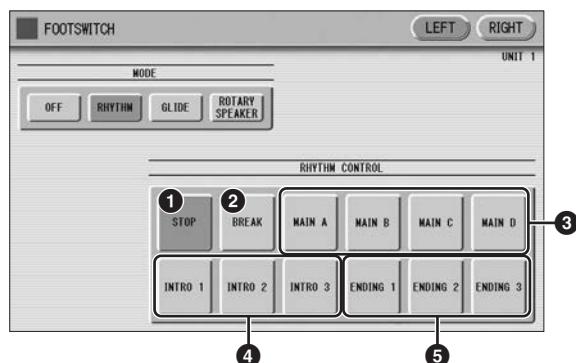

1 STOP

Switches the rhythm on/off whenever you press the Footswitch.

2 BREAK

When you press the Footswitch, the Break section turns on. This function corresponds to the [BREAK] button on the panel.

3 MAIN A – MAIN D

These functions correspond to the MAIN/FILL IN [A] – [D] buttons on the panel. For example, when the [MAIN A] button is selected in this display and you press the Footswitch, the rhythm section switches to Main A or Fill In A.

4 INTRO 1 – INTRO 3

These functions correspond to the INTRO [1] – [3] buttons on the panel. For example, when the INTRO [1] button is selected in this display and you press the Footswitch, the rhythm section switches to Intro 1.

5 ENDING 1 – ENDING 3

These functions correspond to the ENDING [1] – [3] buttons on the panel. For example, when the ENDING [1] button is selected in this display and you press the Footswitch, the rhythm section switches to Ending 1. After the ending pattern is played, the rhythm stops.

Reference page

- Rhythm Structure (page 57)

Controlling Glide

You can control the Glide effect by using the Left Footswitch.

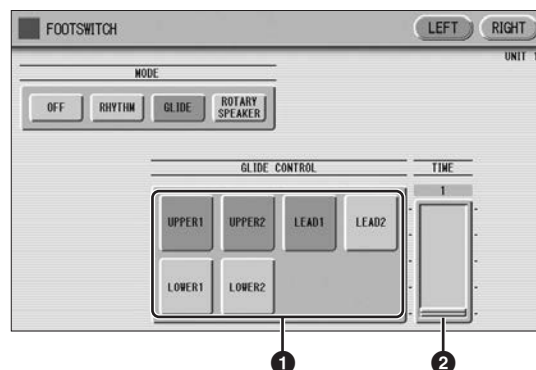

Pressing the Footswitch immediately lowers the pitch of the selected Voice or Voices by a half-step and releasing it slowly returns the pitch to the original.

1 Voice Selections (UPPER1/UPPER2/LEAD1/LEAD2/LOWER1/LOWER2)

Select the desired Voice section(s) to which the Glide function is to be applied.

2 TIME

Determines the speed of the Glide function, or in other words, how gradually the pitch returns when the Footswitch is released. Higher values make the speed slower.

Range: 1 – 5

Controlling Rotary Speaker

You can control the Rotary Speaker effect (on/off) by using the Left Footswitch.

Reference page

- Rotary Speaker (page 49)

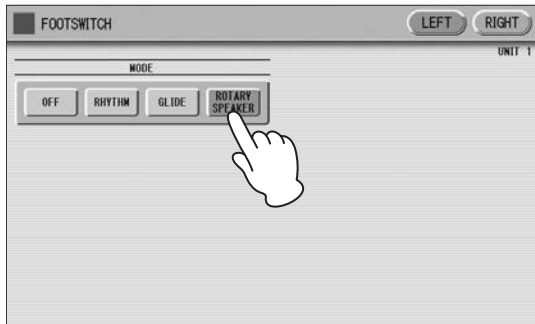

When the [Rotary Speaker] button is selected in this display and you press the Footswitch, the Rotary Speaker effect is switched on or off. This function corresponds to the [ROTARY SP SPEED] button on the panel. To use this function, you'll need to make the appropriate Rotary Speaker settings for each Voice section or Organ Flute Voice. For details, see page 49.

Calling up another page of the music score

From the MDR display, you can call up another page of the music score by using the Left Footswitch. For details, see page 125.

Controlling the Super Articulation Voices

By following the settings on page 45, you can control the Super Articulation Voice (of which the name starts with "S-") by using the Left Footswitch.

Knee Lever

The Knee Lever, located on the underside of the keyboard panel, can be used to turn one of the following on and off: Sustain effect, Melody On Chord function, Lead Slide effect, or Solo function.

NOTE

One or more functions can be assigned to the Knee Lever simultaneously. This enables you to use the Knee Lever to instantly turn on/off all assigned functions.

Controlling Sustain

You can control the on/off status of sustain for the Upper and Lower keyboards by using the Knee Lever. Sustain for the Pedalboard cannot be controlled.

- 1 **Make sure that the Upper and/or Lower Sustain buttons have been turned on.**

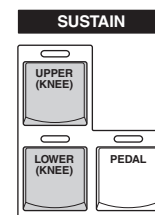

Reference page

- Sustain (page 48)

- 2 **Fold the Knee Lever down.**

Sustain is off when the Knee Lever is folded down.

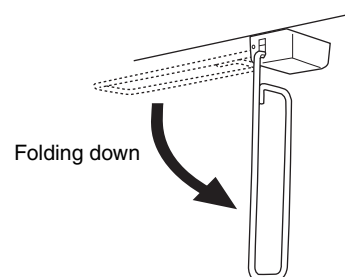

3 To apply sustain, press the Knee Lever to the right.

Sustain is constantly applied as long as the Knee Lever is pressed. Releasing the Knee Lever turns sustain off.

1 When the Knee Lever is folded up:

Sustain is applied constantly, as long as the front panel Sustain buttons are on.

2 When the Knee Lever is vertical:

Sustain is cancelled.

3 When the Knee Lever is continuously pressed to the right:

Sustain is on.

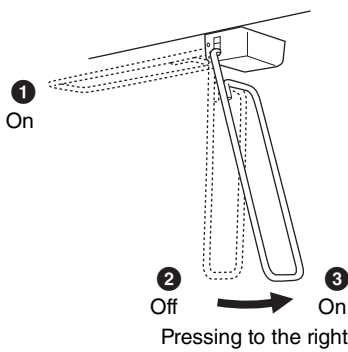

Controlling Melody On Chord

1 Press the [A.B.C./M.O.C.] button on the front panel.

The Melody On Chord section appears in the right half of the display.

2 Set the KNEE control to “ON,” and select one of the modes.

Reference page

- Melody On Chord (page 67)

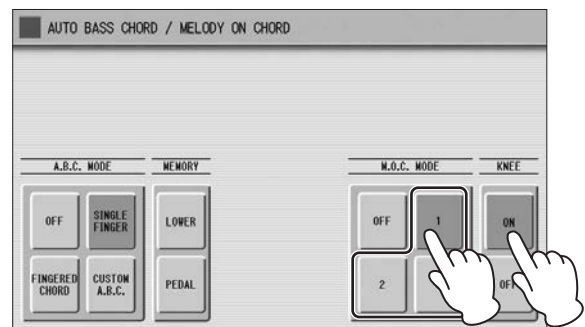
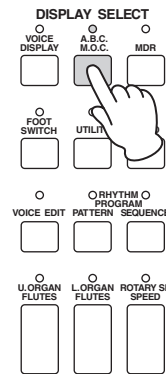

3 Press the Knee Lever to the right with your knee when you want to apply the M.O.C. effect.

The M.O.C. effect is applied constantly, as long as the Knee Lever is pressed.

When you release the Knee Lever, the M.O.C. effect is cancelled.

Controlling Lead Slide

1 Call up the Voice Condition display Page 2 of the Lead Voice section to which you want to apply the Lead Slide effect.

Reference page

- Voice Condition display (page 44)

2 Press the [KNEE] button of the Slide section on the display.

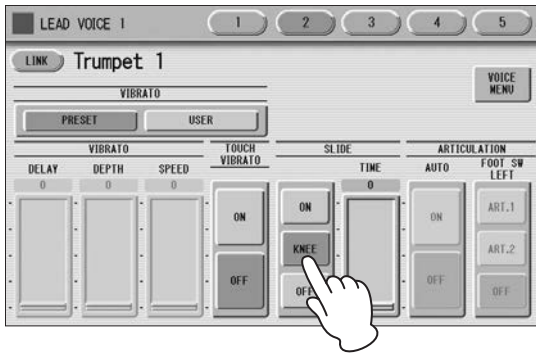

3 Press the Knee Lever to the right with your knee when you want to apply the Slide effect.

The Slide effect is applied as long as the Knee Lever is pressed. Releasing the Knee Lever, cancels the Lead Slide effect.

Controlling the Solo function

You can turn the Solo function on/off by using the Knee Lever. See page 27 for more information.

Expression Pedals

The Expression pedal can be used to control the volume with your foot as you play. Moreover, the ELS-02C has another Expression Pedal, the 2nd Expression Pedal. The 2nd Expression Pedal can be used to control the Pitch Bend and the Tempo of the Rhythm. It also features a center detent for easily returning to the middle (zero) position. The explanation of the 2nd Expression Pedal is given here.

Reference page

- Getting Started (page 13)

2nd Expression Pedal (ELS-02C) Expression Pedal

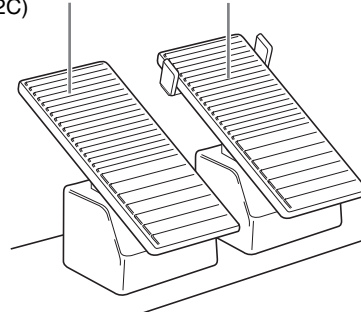

1 Press the [UTILITY] button on the front panel.

The Utility display appears.

2 Press the [EXP.] button in the upper right of the display to call up the EXP. (Expression) Page.

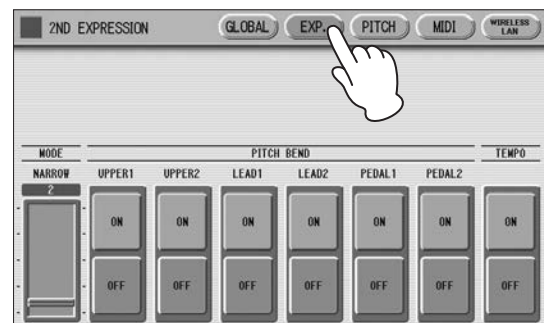
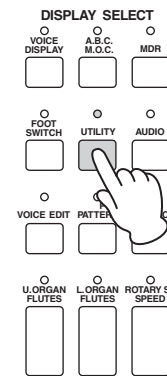

In this display, you can assign the Pitch Bend control or Tempo control to the 2nd Expression Pedal. If both Pitch Bend and Rhythm Tempo controls are set to ON, both functions are applied when you press the 2nd Expression Pedal.

Generally one of them is assigned to the 2nd Expression Pedal.

Controlling Pitch Bend

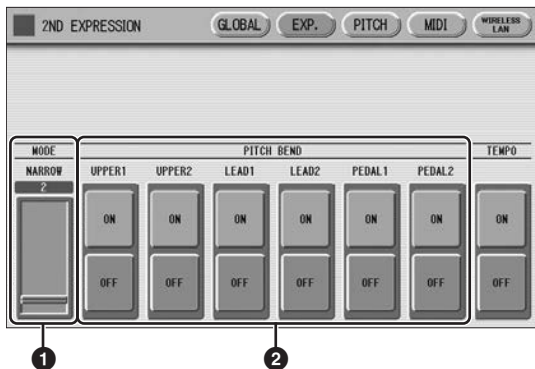

1 MODE

Determines the range of the Pitch Bend control. Each step changes the pitch range by a semitone.

Range: 1 – 12

The setting 2 (NARROW) results in a small amount of pitch variation (over +/- two semitones); the setting 12 (WIDE) results in a large amount of pitch variation (over +/- one octave).

2 Voice Sections (PITCH BEND)

Selects the Voice sections to which the Pitch Bend function will be applied, and turns the function ON. Pitch Bend can be selected independently or together for Upper Voices 1 and 2, Lead Voice 1 and 2, Pedal Voices 1 and 2.

Controlling the Rhythm Tempo

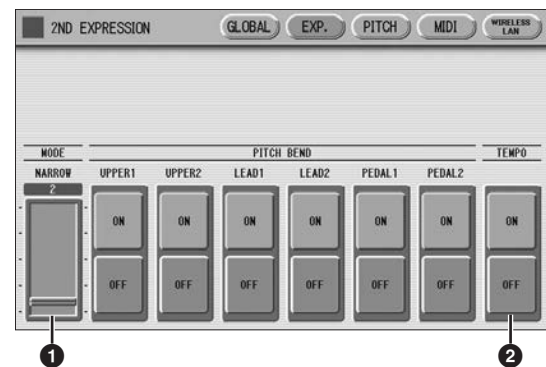

1 MODE

Determines the range of tempo change.

Range: 1 – 12

The setting 2 (NARROW) results in a small amount of tempo change (70% – 140%); the setting 12 (WIDE) results in a large amount of tempo change (50% – 200%).

2 TEMPO

When you want to control the tempo with the 2nd Expression Pedal, set this to “ON.”

When set to on, pressing the pedal down with your toe speeds up the tempo and pressing it back with your heel slows it down. Because of the spring-loaded center detent, you can instantly return to the normal tempo by releasing your foot from the pedal.

12 Transpose and Pitch Controls



There are two pitch-related controls on the Electone: Transpose and Pitch. Transpose allows you to change the key of the instrument and Pitch lets you finely adjust the tuning. Transpose and Pitch can be adjusted in the Utility display. (The settings here cannot be recorded to the Music Data Recorder.)

1 Press the [UTILITY] button.

The Utility display appears.

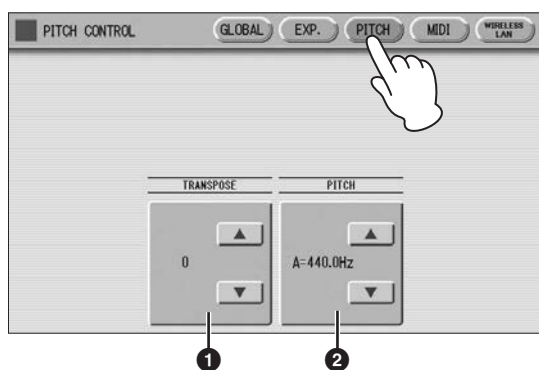
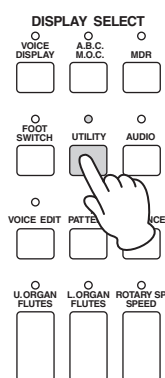
2 Press the [PITCH] button at the top right of the display to call up the PITCH Page.



In this display, you can change the Transpose and Pitch settings by using the   buttons on the display or the Data Control dial.

1 TRANSPOSE

Determines the coarse pitch setting of all the Voices, and is adjustable in half-steps (semitones).

Range: -6 - +6

2 PITCH

Determines the fine pitch setting of all the Voices. Each step changes the pitch by 0.2 Hz. The default Pitch is 440.0 Hz (corresponding to key A3).

Range: 427.2 Hz - 452.6 Hz

You can also change the Transpose and Pitch for each Voice section, in the Voice Condition display. For more information, see page 46.

NOTE

The Transpose/Pitch setting here is not applied to an XG Song.

13 Connections

On the underside of the Electone keyboard is a separate panel equipped with various input/output terminals and miscellaneous controls.

Accessory Jacks and Controls

This section provides brief explanations for each jack/control on the Electone. For details on connecting to external devices, see page 187.

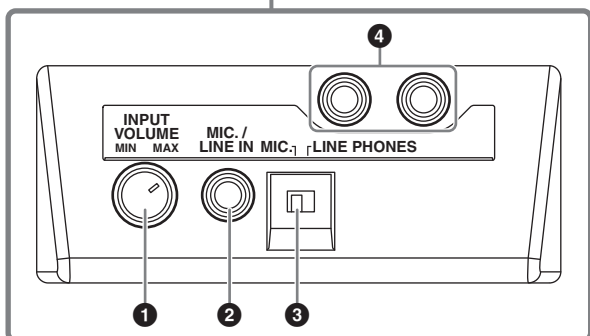
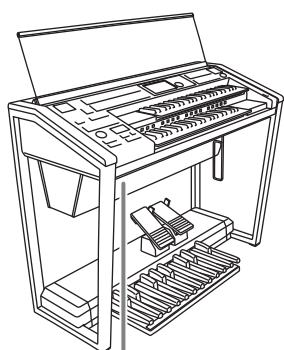

1 INPUT VOLUME knob

For adjusting the level of input signal from the MIC./LINE IN jack.

2 MIC./LINE IN jack

For connecting a mono input, such as microphone or guitar. The Electone outputs the microphone or guitar sounds, with reverb processing, through the built-in speaker system.

Reference page

- Connecting a microphone or guitar (page 189)

3 MIC./LINE switch

When connecting a microphone or other electric/electronic instrument to the MIC./LINE IN jack, make sure to set this level gain switch appropriately, depending on the device you use.

4 PHONES jacks

For connection of a stereo headphone set. When headphones are connected to this jack, sound to the Electone's built-in speaker system is automatically cut off, allowing you to play without disturbing others.

Reference page

- Using headphones (page 187)

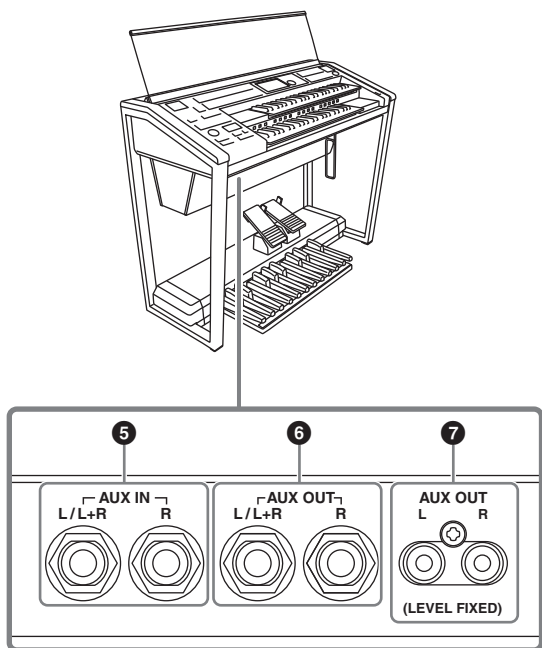

5 AUX IN (Phone; L/L+R, R) jacks

This pair of stereo phone jacks is for connection to an external device. The signal from the connected external device sounds from the Electone's built-in speakers.

Reference page

- Outputting the sound of an external device through the built-in speakers of the Electone (page 189)

6 AUX OUT (Phone; L/L+R, R) jacks

This pair of stereo outputs is for connection to an external amplifier/speaker system.

The output level can be controlled with the MASTER VOLUME dial.

Reference pages

- Playing the sounds of the Electone through an external audio system (page 187)
- Recording the sounds of the Electone to an external recorder (page 188)

7 AUX OUT (RCA; L, R) jacks (LEVEL FIXED)

This set of stereo outputs is for connection to an external amplifier/speaker. The output level is fixed and cannot be controlled.

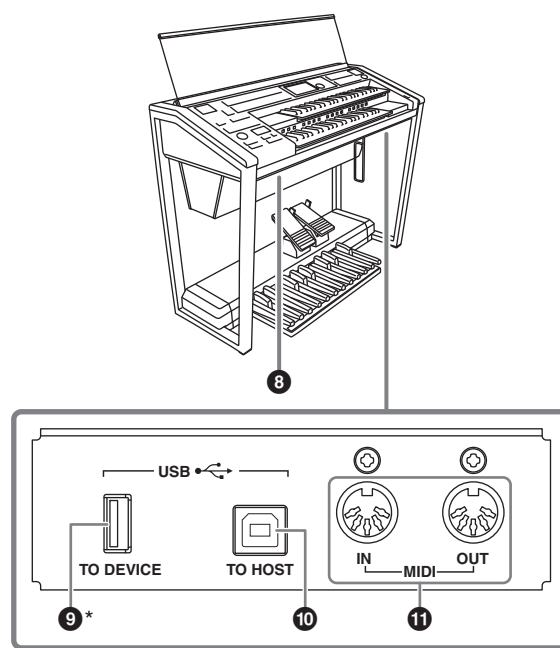

* An ELS-01 series instrument with an installed STAGEA Vitalize unit has two [USB TO DEVICE] terminals installed here.

8 USB Dock

The ELS-02 series features a USB Dock built into the left front of the keyboard unit, containing two [USB TO DEVICE] terminals. Since the USB Dock opens slightly (more than 10mm) when it is pushed gently, pull it open all the way and connect the USB flash drive to one of the [USB TO DEVICE] terminals.

CAUTION

While playing the keyboard, make sure to close the USB Dock. Otherwise, your hand may hit the Dock, causing injury and/or damage to the Dock or USB flash drive. Furthermore, make sure to remove the cap or strap of the USB flash drive in order to be able to close the USB Dock firmly.

NOTICE

- Never connect a USB device which is physically larger than the inside of the USB Dock, to avoid damaging the USB flash drive and/or the Dock.
- Never strap or hang anything onto the USB Dock or apply any load or force to the Dock, to avoid damaging it.

NOTE

- Only a USB flash drive can be connected to each of the [USB TO DEVICE] terminals in the USB Dock.
- An ELS-01 series instrument with an installed STAGEA Vitalize unit does not have a USB Dock installed.

9 [USB TO DEVICE] terminals

For details on [USB TO DEVICE] terminal, see page 110.

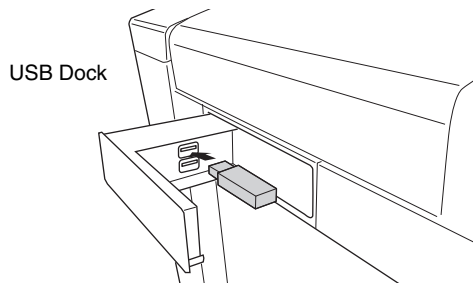

10 [USB TO HOST] terminal

This terminal can be connected to the USB terminal of the computer using the USB cable. (The USB-MIDI driver is necessary for the connection.)

Reference page

- Connection with Computer (page 191)

USB

USB is an abbreviation for Universal Serial Bus. It is a serial interface for connecting a computer with peripheral devices.

11 MIDI IN/OUT terminals

For connecting external MIDI devices such a synthesizer or sequencer. You can also use these to connect with a computer that has a MIDI Interface.

Reference pages

- Controlling external MIDI devices from the Electone (page 190)
- Controlling the Electone from an external device (page 190)
- Connection with Computer (page 191)

Connection Examples – External Devices

CAUTION

Before connecting the Electone to other electronic components, turn off the power to all the components. Before turning the power of the components on or off, set all volume levels to minimum (0). Otherwise, electrical shock or damage to the components may occur.

Using headphones

To use headphones, connect them to one of the PHONES jacks (standard 1/4" phone jacks). Two people can enjoy listening to the Electone together by connecting two pairs of headphones to the two jacks.

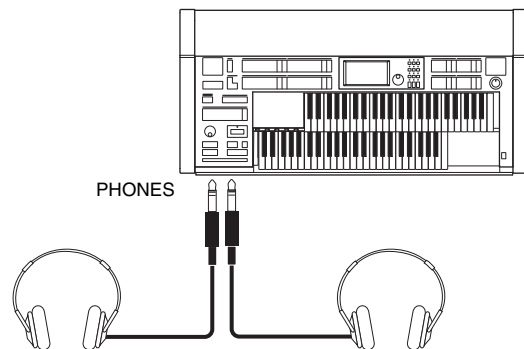

Playing the sounds of the Electone through an external audio system

By using the AUX OUT jacks, you can connect your Electone to external speakers. If you're connecting the Electone to a mono device, use only the AUX OUT L/ L+R jack (standard phone).

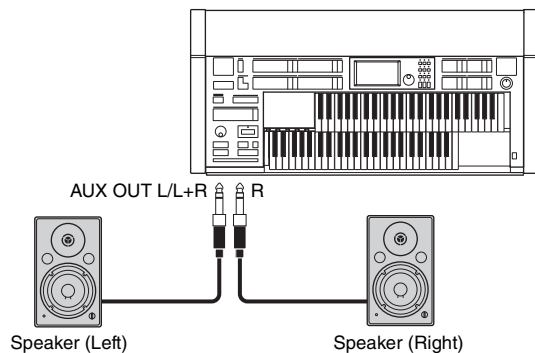

Connection example: Using a mixer for live performance

Generally, when you use the Electone on stage (in concert, etc.), you should connect it to a mixer. By using a mixer, you can easily adjust the volume and tone quality of each component. To connect to a mixer, use the AUX OUT jacks of the Electone. The Electone features different types of AUX OUT jacks, allowing you to choose the appropriate one for your specific application.

Jacks	Output Type	Location
AUX OUT phone jacks L/L+R, R	Balanced* Level is controlled with the MASTER VOLUME dial.	Left underside of the keyboard
AUX OUT RCA pin jacks L, R	Unbalanced* LEVEL FIXED	Left underside of the keyboard

*The balanced connection is best for long cable runs, or for low-level signals, since it picks up less noise than unbalanced lines.

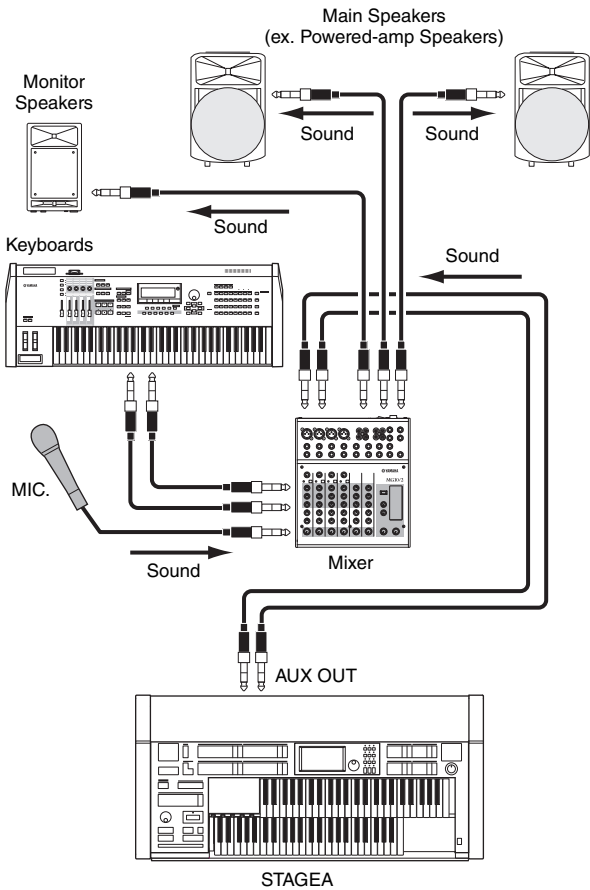

Power-on procedure

Before turning the power on to all components, set all volume levels to minimum (0) then turn on the power in the following order:

- (1) Electone and external keyboard(s)
- (2) Mixer
- (3) Powered Speaker

To turn the power off, first turn down the volume for each device, then turn off the power in the reverse order (3 → 2 → 1).

Recording the sounds of the Electone to an external recorder

By using the AUX OUT jacks, you can record your performance sound to an external audio recorder. When connecting, use either the pin jack or phone jack depending on the particular type of the cable's jack.

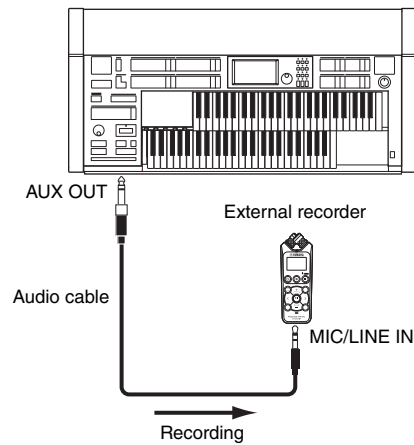

NOTE

If you want to record the sound input from the AUX IN jack together with the Electone sound, use the AUX OUT standard phone jack on the underside of the keyboard.

Outputting the sound of an external device through the built-in speakers of the Electone

By connecting a cable from the external audio device to the AUX IN jacks, you can play back the sound of the external device via the speakers of the Electone.

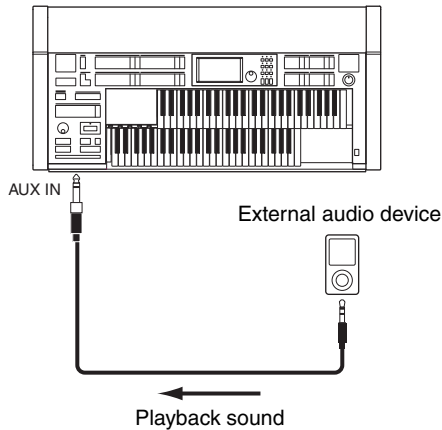

NOTICE

To avoid damage to the devices, first turn on the power to the external device, then to the instrument. When turning off the power, first turn off the power to the instrument, then to the external device.

NOTE

- Use audio cables and adaptor plugs having no (zero) resistance.
- The instrument's [MASTER VOLUME] setting affects the input signal from the [AUX IN] jack.

Connecting a microphone or guitar

By connecting a microphone to the Electone, you can enjoy singing along with your own performance. The Electone outputs your vocals or guitar sounds through the built-in speakers.

- 1 **Connect your microphone to the MIC./LINE IN jack (standard 1/4" phone jack).**
A dynamic microphone is recommended.

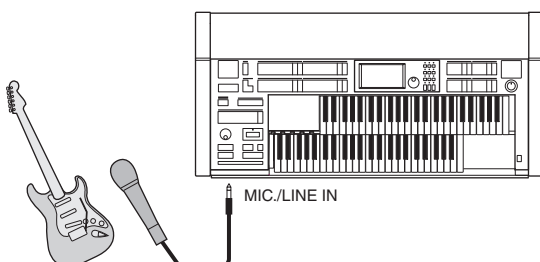

- 2 **Set the MIC./LINE switch to the MIC position when connecting a microphone, or the LINE position when connecting a guitar or other high-level output device.**

MIC. LINE



When connecting a microphone

MIC. LINE

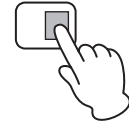

When connecting a guitar

NOTE

When you're not sure which position is the best, first set it to LINE. If the output level is too low, switch to the MIC position.

- 3 **Use the INPUT VOLUME knob to set the microphone volume.**



To adjust the volume/reverb:

- 1 **Press the [UTILITY] button on the panel to call up the Utility display.**
- 2 **Using the MIC. REVERB and VOLUME sliders in the GLOBAL Page, adjust the amount of the reverb applied to the microphone, and the volume.**

Reference page

- Reverb (page 46)

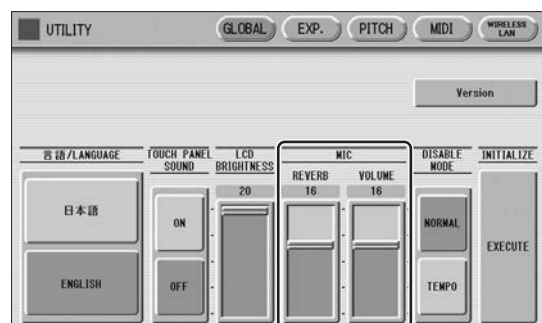

No sound from the microphone can be heard even though you raise the volume here, unless you turn the INPUT VOLUME knob to the right. Similarly, no reverb can be heard even though you raise the reverb level here, unless you raise the total reverb level with the panel REVERB control.

Controlling external MIDI devices from the Electone

You can use the Electone to remotely play the Voices of a MIDI keyboard (or tone generator), combining them with the Electone and letting you create even richer, more multi-layered sound textures. (The MIDI receive channels of the MIDI keyboard must match the transmit channels on your Electone.)

The Electone transmits as digital data a variety of performance messages along with note information, including values that indicate how far the expression pedal is pressed down and how hard you play the keyboard. How the connected external device responds to these messages depends on the particular device.

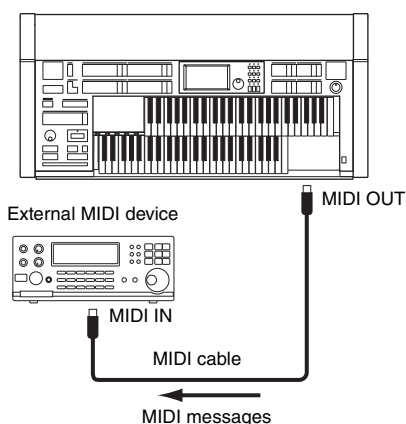

If you use both the [USB TO HOST] terminal and MIDI terminals simultaneously, MIDI communication will be available only via the [USB TO HOST] terminal, and the MIDI terminal cannot be used.

NOTE

When you are using the MDR, MIDI data cannot be transmitted.

Controlling the Electone from an external device

You can use an external MIDI keyboard or sequencer to remotely play the sounds of your Electone and change its Registrations. (You will need to set the MIDI transmit channels of the MIDI keyboard to match the fixed receive channels on your Electone.)

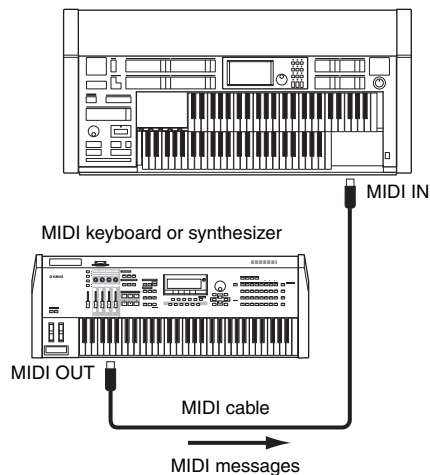

If you use both the [USB TO HOST] terminal and MIDI terminals simultaneously, MIDI communication will be available only via the [USB TO HOST] terminal, and the MIDI terminal cannot be used.

NOTE

When you are using the MDR, MIDI data cannot be received.

Connection with Computer

By using the [USB TO HOST] terminal or MIDI terminals, you can connect the Electone and computer enabling the MIDI communication between both. Install the USB-MIDI driver to your computer, then make the MIDI connection between the Electone and computer. Regarding the USB-MIDI driver, you can download the latest version from the Yamaha website: <http://download.yamaha.com/>

Connecting your Electone to a computer opens up a whole new world of musical possibilities. You can save your original Songs to computer and create notation (score writing application or sequencing software is needed), and even upload your original Electone Song data to your own website, to promote your talents or share Songs with your friends. You can also control the Electone from the computer, for example, by playing a MIDI file on the computer to play back the sounds of your Electone.

NOTE

When you are using the MDR, MIDI data cannot be transferred from the computer.

Connecting to a Computer ([USB TO HOST] terminal)

The [USB TO HOST] terminal of the Electone can be connected to the USB terminal of the computer using a USB cable.

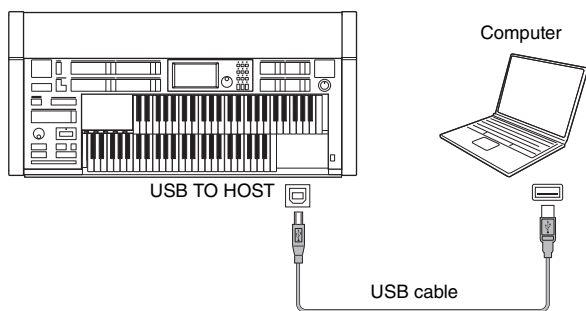

If you use both the [USB TO HOST] terminal and MIDI terminals simultaneously, MIDI communication will be available only via the [USB TO HOST] terminal, and the MIDI terminal cannot be used.

Precautions when using the [USB TO HOST] terminal

When connecting the computer to the [USB TO HOST] terminal, make sure to observe the following points. Failing to do so risks freezing the computer and corrupting or losing the data. If the computer or the instrument freezes, restart the application software or the computer OS, or turn the power to the instrument off then on again.

NOTICE

- Use an AB type USB cable of less than 3 meters. USB 3.0 cables cannot be used.
- Before connecting the computer to the [USB TO HOST] terminal, exit from any power-saving mode of the computer (such as suspend, sleep, standby).
- Before turning on the power to the instrument, connect the computer to the [USB TO HOST] terminal
- Execute the following before turning the power to the instrument on/off or plugging/unplugging the USB cable to/from the [USB TO HOST] terminal.
 - Quit any open application software on the computer.
 - Make sure that data is not being transmitted from the instrument. (Data is transmitted only by playing notes on the keyboard or playing back a Song.)
- While the computer is connected to the instrument, you should wait for six seconds or more between these operations: (1) when turning the power of the instrument off then on again, or (2) when alternately connecting/disconnecting the USB cable.

Connecting to a Computer (MIDI terminal)

By using an optional MIDI interface such as the UX16, you can connect the Electone to the computer, with the MIDI IN/OUT terminals on the instrument. Connect the Electone and the MIDI Interface with two standard MIDI cables (one connecting the OUT terminal on the Electone to the MIDI IN terminal on the interface, and the other connecting the IN terminal on the Electone to the MIDI OUT terminal on the interface). Connect the MIDI interface to the computer with a USB cable.

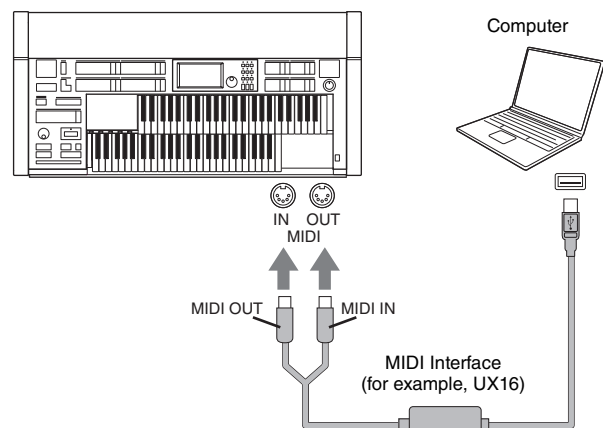

MIDI Control

When you connect your Electone with a second MIDI device (such as a synthesizer or computer), you can determine how the Electone controls that MIDI device, or how the Electone is controlled.

- 1 Press the [UTILITY] button in the panel to call up the Utility display.
- 2 Press the [MIDI] button at the top right of the display to call up the MIDI Page.

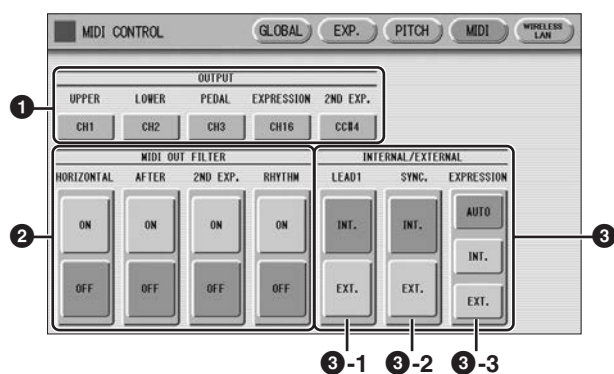

1 OUTPUT

For setting the channels over which MIDI information will be transmitted. Any channel from 1 through 16 can be assigned to each keyboard (the Upper keyboard, the Lower keyboard and the Pedalboard) as well as the Expression pedal and 2nd Expression pedal. The MIDI messages for each keyboard and Expression pedal will be sent on the channels set here. You must set the transmit channel here to match the receive channel of the connected device. (The ELS-02 does not show the 2nd Expression pedal.)

Pressing each OUTPUT button calls up the channel selection pop-up menu. After you select the desired channel, the pop-up menu automatically closes. The Expression pedal and 2nd Expression pedal can be set to "OFF" (MIDI information will not be transmitted). On the 2nd Expression pedal, CC#4 by which MIDI information is output as Second Expression can be also set.

2 MIDI OUT FILTER

Deletes unnecessary MIDI data and keeps it from being transmitted from the Electone. After Touch and Rhythm start/stop are automatically filtered on the ELS-02.

In addition, Horizontal Touch and Second Expression are automatically filtered on the ELS-02C. Set the parameter for which you wish to disable transmission to ON.

NOTE

If you set Second Expression to on in the MIDI OUT FILTER parameters, the setting in the OUTPUT (1) parameters will be disabled.

3 INTERNAL/EXTERNAL

Switches control over the displayed items between the Electone (INTERNAL) or the connected device (EXTERNAL).

3 -1 LEAD 1

Determines Internal or External control of the Lead Voices.

INT. (Internal): Lead Voice 1 is played from the Upper keyboard of the Electone. (If the To Lower function is on, it is played from the Lower keyboard.)

EXT. (External): Lead Voice 1 is played from the connected instrument via MIDI channel 4.

3 -2 SYNC.

To synchronize playback with an external MIDI device, you can use either the instrument's internal clock (INT.) or MIDI clock signals from the external device (EXT.).

INT. (Internal): The instrument uses its own internal clock.

EXT. (External): The instrument uses MIDI clock signals from the external device (MIDI).

3 -3 EXPRESSION

Determines the control of the expression pedal functions. Ordinarily, this control is set to AUTO.

AUTO: Internal and External is automatically switched.

INT. (Internal): You can manually control the expression pedal even during MDR playback.

EXT. (External): While playing the MDR or receiving MIDI messages, the expression pedal is invalid. (The volume is controlled by the recorded data in a USB flash drive or received MIDI data.)

Connecting to an iPhone/iPad

You can connect a smart device such as an iPhone or iPad to the instrument. By using an application tool on your smart device, you can take advantage of convenient functions and get more enjoyment out of this instrument.

For details on connections, refer to the “iPhone/iPad Connection Manual” on the website.

<http://download.yamaha.com/>

For information about compatible smart devices and application tools, access the following page:

<http://www.yamaha.com/kbdapps/>

Connection with a USB wireless LAN adaptor (sold separately)

The USB wireless LAN adaptor lets you connect the Electone to an iPhone/iPad wirelessly. For details about the USB wireless LAN adaptor, contact your nearest Yamaha representative or the distributor listed at the end (or beginning) of this manual. Or you can access the following website and contact Yamaha support at your location.

<http://www.yamaha.com/contact/>

To enable a wireless connection between the Electone and an iPhone/iPad, follow the instructions in the “iPhone/iPad Connection Manual” on the website, and also refer back to “Wireless LAN settings” in this manual for the specific Wireless LAN settings you’ll need to make for wireless connection.

NOTE

MIDI and [USB TO HOST] terminals are automatically disabled when the USB wireless LAN adaptor is connected.

Wireless LAN settings

Start wireless connection according to the instructions in the “iPhone/iPad Connection Manual” on the website, then make sure to make appropriate setups from the following instructions: “Automatic Setup by WPS,” “Displaying available networks in the wireless LAN and connecting to a network,” “Manual Setup” or “Connecting by the Ad Hoc Mode.” Refer to pages 194 – 197 in this Manual, then set up as required. If there is no access point, follow the instructions in “Connecting by the Ad Hoc Mode” (page 197).

Reference Page

- Wireless LAN Detailed Settings (page 198)
- Initialize the wireless LAN settings (page 200)

NOTICE

- **When you use the instrument along with an application on your iPhone/iPad, we recommend that you first set “Airplane Mode” to “ON” then set “Wi-Fi” to “ON” on your iPhone/iPad in order to avoid noise caused by communication.**
- **Do not place your iPhone/ iPad in an unstable position. Doing so may cause the device to fall and result in damage.**

NOTE

Before using the [USB TO DEVICE] terminal, be sure to read “Precautions when using the [USB TO DEVICE] terminal” on page 110 in chapter 7.

Automatic Setup by WPS

If your access point supports WPS, you can easily connect the instrument to access point by WPS, without making settings, such as key input, etc.

NOTE

Check whether your access point supports WPS by referring to the owner's manual for the access point you are using.

- 1 **Connect the USB wireless LAN adaptor.**
- 2 **Press the [UTILITY] button, then press the [WIRELESS LAN] button on the display to call up the WIRELESS LAN Page.**

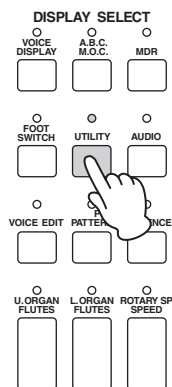

Wireless LAN mode



- 3 **Make sure that the wireless LAN mode is set to Infrastructure Mode.**

If the wireless LAN mode is set to Ad Hoc Mode, press the [MODE CHANGE] button in the display to switch to the Infrastructure Mode (page 197).

- 4 **Press the [WPS] button in the WIRELESS LAN Page.**

A message appears prompting confirmation of operation. You can cancel the operation at this point by pressing the [CANCEL] button.

- 5 **Press the [OK] button to start WPS setup, then press the WPS button on your access point within two minutes.**

The “Connected” indication appears when connection between the instrument and the access point is successful.

“Connected” indication appears.



- 6 **After successfully enabling connection between the instrument and the access point, connect the iPhone/iPad to the access point by referring to the “iPhone/iPad Connection Manual.”**

Displaying available networks in the wireless LAN and connecting to a network

Select the desired Network for connection from the Network list in the display by following the steps below.

- 1 **Connect the USB wireless LAN adaptor.**
- 2 **Press the [UTILITY] button, then press the [WIRELESS LAN] button on the display to call up the WIRELESS LAN Page.**

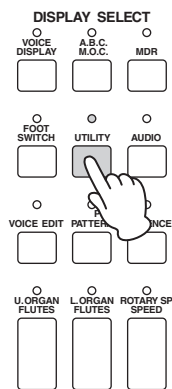

Wireless LAN mode

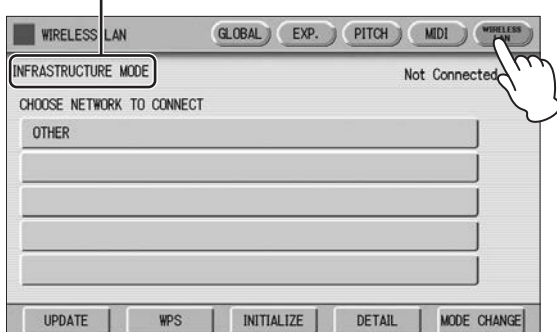

- 3 **Make sure that the wireless LAN mode setting is Infrastructure Mode.**

When the wireless LAN mode is Ad Hoc mode, press the [MODE CHANGE] button in the display to switch to the Infrastructure Mode (page 197).

- 4 **Press the [UPDATE] button in the display to call up the network list.**

For a network with a lock icon (🔒), you need to enter the proper password.

- 5 **Select the desired network by pressing the button shown the name of the network in the display.**

For a network without a lock icon:
Connecting starts.

For a network with a lock icon:
You need to enter the proper password, which is identical to that in the settings on the Access Point. For details on how to enter characters, refer to the "Changing the Song Name" on page 116. After entering the password, press the [OK] button in the display to finalize the setting. This operation starts connecting automatically.

The "Connected" indication appears when the instrument and the access point have been successfully connected.



- 6 **After successfully enabling connection between the instrument and the access point, connect the iPhone/iPad to the access point by referring to the "iPhone/iPad Connection Manual."**

Manual Setup

If you cannot find the desired network on the display, it may be a network that is closed or hidden. In this case, you will need to manually input SSID, Security and Password settings for connection.

NOTE

About the confirmation and changes in the access point settings, refer to the manual of the access point.

1 Perform the same operation as in steps 1 – 3 in the “Displaying available networks in the wireless LAN and connecting to a network” instructions on page 195.

2 Press to select [OTHER] at the bottom of the network list.

The OTHER NETWORK display will be shown.

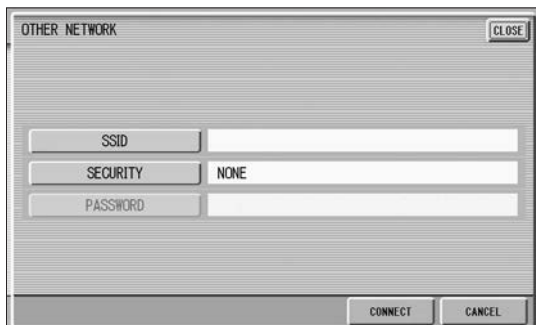

3 Set the SSID, Security and Password to the same as the settings on the access point.

Set the same contents with the setting contents by the access point side.

SSID

Press the [SSID] button in the display to call up the display for SSID input, then enter the SSID. For details on how to enter the characters, refer to the “Changing the Song Name” on page 116. Up to 32 characters (half size), alphanumeric characters, marks can be entered. After entering the SSID, press the [OK] button to finalize the setting.

SECURITY

Press the [SECURITY] button in the display to call up the display for security select, then press either the [NONE], [WPA2-PSK (AES)] or [WEP] button.

PASSWORD

Press the [PASSWORD] button to call up the display for Password input, then set the password in the same way as SSID. Press the [OK] button to finalize the setting.

NOTE

The password cannot be set when you select [NONE] for the security setting.

4 Press the [CONNECT] button to start connection.

The “Connected” indication appears when the instrument and the access point have been successfully connected.



5 After successfully enabling connection between the instrument and the access point, connect the iPhone/iPad to the access point by referring to the “iPhone/iPad Connection Manual.”

Connecting by the Ad Hoc Mode

1 Set the Wireless LAN mode to “Ad Hoc Mode.”

Refer to “Wireless LAN Mode.”

2 The settings for the instrument are complete if you do not need to change the SSID and so on. Connect the iPhone/iPad to the instrument by referring to the “iPhone/iPad Connection Manual.”

You can change the SSID, Security, etc. from the DETAIL display.



Reference Page

- Wireless LAN Detailed Settings (page 198)

Wireless LAN Mode

1 Perform the same operation as in steps 1 – 3 in the “Displaying available networks in the wireless LAN and connecting to a network” instructions on page 195.

2 Set the Wireless LAN mode.

You can set between two modes: INFRASTRUCTURE and AD HOC. Press the [MODE CHANGE] button on the display to call up a message prompting confirmation of the operation, then press the [OK] button to execute the operation.

Wireless LAN Detailed Settings

You can set the detailed settings for each mode: INFRASTRUCTURE and AD HOC. There is no need to change or make any settings if you've enabled connection between the iPhone/iPad and instrument.

 **Reference Page**

- Wireless LAN Mode (page 197)

- 1 **Set the Wireless LAN mode, then call up the display for detailed settings by pressing the [DETAIL] button in the WIRELESS LAN display.**

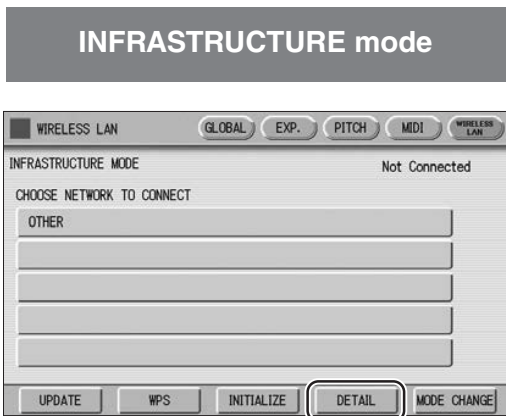

DETAIL (IP ADDRESS) ↓



DETAIL (OTHER) ↓

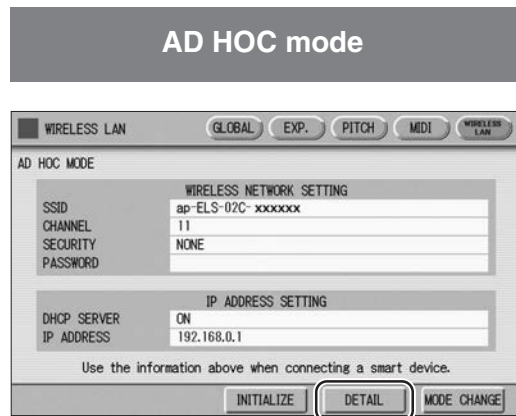

DETAIL (WIRELESS) ↓

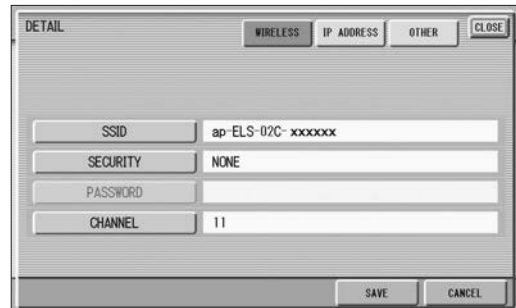

DETAIL (IP ADDRESS) ↓

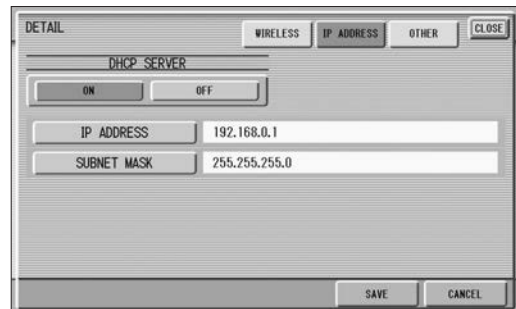

DETAIL (OTHER) ↓



2 As necessary, set the detailed settings.

Wireless LAN mode	Display	Item	Default setting	Setting/Input
INFRASTRUCTURE mode	DETAIL (IP ADDRESS) display	DHCP	ON	Determines whether or not DHCP is used. If your router is compatible with DHCP, select [ON] (set DNS automatically) here. Select on or off by pressing [ON] or [OFF] button on the display.
		IP ADDRESS	0.0.0.0	Set the wireless LAN detailed settings. IP Address, Subnet Mask, Gateway, DNS Server1, DNS Server2 can be set when DHCP is set to Off but cannot be set when DHCP set to On. For details on confirmation and changes in the setting of the access point on the router side, refer to the owner's manual for the product you are using. For details on how to enter characters, refer to the instructions "Changing the Song Name" on page 116. The setting range is 0.0.0.0 – 255.255.255.255.
		SUBNET MASK	0.0.0.0	
		GATEWAY	0.0.0.0	
		DNS SERVER 1	0.0.0.0	
DNS SERVER 2	0.0.0.0			
AD HOC mode	DETAIL (WIRELESS) display	SSID	ap-(model name, such as "ELS-02C")-(last 6 characters of MAC address in lowercase); or simply "ap-(model name)," if MAC address cannot be used.	<p>To find the specific MAC address, see "MAC address" below.</p> <ul style="list-style-type: none"> • SSID, Security and Password can be set in the same way as those described in the section "Manual Setup" on page 196. The last 6 characters of the MAC address must be entered in lowercase. • Press the number button which appears by pressing the [CHANNEL] button on the display then, select the channel. • DHCP and IP Address can be set in the same way as those of INFRASTRUCTURE mode in this table. • Subnet Mask can be selected in the list.
		CHANNEL	11	
		SECURITY	–	
		PASSWORD	–	
	DETAIL (IP ADDRESS) display	DHCP	ON	
		IP ADDRESS	192.168.0.1	
		SUBNET MASK	255.255.255.0	
INFRASTRUCTURE mode / AD HOC mode	DETAIL (OTHER) display	HOST NAME	(Model name, such as "ELS-02C")-(last 6 characters of MAC address in lowercase); or simply "(model name)," if MAC address cannot be used.	Set the Host name. Up to 57 characters (half size) including alphanumeric characters, the "_" (underscore) and "-" (hyphen) character. For details on how to enter characters, refer to the instructions "Changing the Song Name" on page 116. After entering the characters, press the [OK] button on the display to finalize the setting. The last 6 characters of the MAC address must be entered in lowercase.
		MAC ADDRESS	–	Shows the MAC address of the USB wireless LAN adaptor. You cannot change the MAC address here.
		LAN DRIVER VERSION	–	This only displays the version of the LAN driver; the setting cannot be made.
		STATUS	00000000	Shows the error code of network function. "00000000" means no error.

3 Save the settings.

Set the detailed settings, then press the [SAVE] button on the display. When the saving operation is completed, the detailed settings display returns to the previous display.

Initialize the wireless LAN settings

“Factory Set (Initializing the Electone)” on page 23 in chapter 1 does not affect the wireless LAN settings, which can be initialized by the following procedure. Be careful when executing initialize, since it erases all the wireless LAN settings and replaces them with the factory defaults.

- 1 Press the [UTILITY] button, then press the [WIRELESS LAN] button on the display to call up the WIRELESS LAN Page.



- 2 Initialize the wireless LAN settings.

Press the [INITIALIZE] button on the display. A message appears prompting confirmation of operation. Press the [OK] button to execute the operation, or the [CANCEL] button to cancel.

Glossary of Terms

Access point	A device which acts as a base station when transmitting data by wireless LAN. Some access points are combined with modem functions.
Ad Hoc mode	Communication method for performing data communication with the terminal and other devices directly without using a relay device, such as an access point of a wireless LAN.
DHCP	A standard or protocol by which IP addresses and other low-level network configuration information can be dynamically and automatically assigned each time the computer and the instrument connect to the Internet.
DNS server	A server that maps names to actual IP addresses of devices connected to a network.
Gateway	A Gateway is a link between two computer programs or systems.
Infrastructure mode	Communication method for performing data communication with each terminal via a relay device, such as an access point of the wireless LAN.
IP address	A string of numbers assigned to each computer connected to a network that indicate the device's location on the network.
LAN	Short for Local Area Network, this is a data-transfer network that connects a group of computers at a single location (such as an office or home) by means of a special cable.
Router	A device that allows multiple devices (e.g., computers, your Yamaha instrument) to share the same Internet connection.
Site	Short for "website," this refers to the group of web pages that are opened together. For example, the collection of web pages whose addresses begin with "http://www.yamaha.com/" is referred to as the Yamaha site.
SSID	A name used to identify a particular access point, or the wireless networks set as the access point.
Subnet mask	The structure for dividing a large-scale network.
Wireless LAN	A LAN connection that allows data transfer through a wireless, cable-free connection.
WPS	A structure to easily make a setting of wireless LAN by pushing only the WPS buttons of an access point and the wireless LAN device.

14 Appendix

Troubleshooting

Problem	Possible Cause and Solution
GENERAL OPERATION	
A click or pop is heard when the power is turned on or off.	Electrical current is being applied to the instrument. This is normal.
The sound is not heard for about 10 seconds after turning the power on.	This is normal; the Electone takes a while to start up.
A cracking noise is sometimes heard.	Noise may be produced when either an electrical appliance is turned on or an electric power tool (such as drill) is used in the proximity of the Electone. If this occurs, plug the Electone into an electrical outlet located as far as possible from the device that seems to be the source of the problem.
Interference from radio, TV, or other sources occurs.	This is caused by the proximity of a high-power broadcasting station, an amateur ham radio setup or a mobile phone.
The sound of the Electone causes surrounding objects to resonate.	Because the Electone is capable of producing powerful bass sounds, resonance may be caused in surrounding objects, such as cabinets or glass windows. To avoid this, relocate the objects or lower the Electone's volume.
In the LCD display, there are some black points (unlit) or white points (always lit).	Unfortunately, this is a common characteristic of TFT-LCDs.
Some buttons on the panel do not respond.	The UPPER/LOWER ORGAN FLUTES and LEAD VOICE 2 buttons are invalid on the ELS-02. If you upgrade the ELS-02 to the ELS-02C, these buttons can be used.
Some of the LEDs in the DISPLAY SELECT section do not light.	The LEDs of on/off buttons (UPPER/LOWER ORGAN FLUTES, VOICE EDIT, RHYTHM PROGRAM, and ROTARY SP SPEED) are lit when those functions are turned on. The LEDs of other function's buttons momentarily light when the functions are selected.
The sound is too small even when the volume is set to its maximum.	<ul style="list-style-type: none"> The Master Volume may be set around the minimum position. Turn it clockwise. The Expression Pedal may not be pressed down. Press it down with your toe. The POWER switch of the speaker may have been turned off. Turn it on. (For the ELS-02C) The REAR SPEAKER switch may have been set to OFF. Switch it to ON.
The Electone panel does not function normally or the content of the memorized data has changed.	This happens very rarely. Occasionally, power surges and spikes due to electrical storms or other reasons may cause the Electone to malfunction and/or alter the contents of memorized data. If this happens, perform the Factory Set operation to reset the Electone (page 23).
VOICES/RHYTHMS	
The pitch may sound excessively high on the Pedalboard and low in the higher registers of the Lower and Upper keyboards.	This may occur when you compare the Electone's sounds with that of a piano. Because of the difference of the harmonics structure, the tuning system of the Electone is different from the piano in the higher and lower ranges.
Some of the Voices may contain cracking and/or noisy sounds.	You may find these mainly in the wind instrument Voices. These are purposely added effects to the Voices to reproduce the characteristics of the wind instruments such as the pipe vibrations, breath noises and squeaks.
When too many keys are pressed, not all of the notes sound.	Total polyphonic capacity (notes sounding for both Upper and Lower Keyboards) is 14 notes. When you turn the Pedal Polyphonic mode to on, the total is 14 for all keyboards, Upper, Lower and Pedalboard.
When sustain length is set to HOLD, previously played notes are cut off.	Since the HOLD setting causes notes to keep sounding, the cumulative notes (elements) may go over the maximum elements that the Electone can sound. When this occurs, previously played notes are cut off.

Problem	Possible Cause and Solution
Only one sound is heard when two notes of the Lead or Pedal Voices are simultaneously played.	For practical performance reasons, the Electone has been designed so that only one note of the Lead or Pedal Voices can be played at a time. If you want, the Pedal Voice can be set to polyphonic mode (page 44).
The Pedal Voices do not sound, even though the volume is properly set.	<ul style="list-style-type: none"> • The Single Finger or Fingered Chord mode of Auto Bass Chord is on. Turn off the mode in the display (page 66). • TO LOWER buttons in the Pedal Voice sections are turned on. Turn the function off (page 27).
When selecting a User button Voice or rhythm, the Voice or rhythm title at the top of the LCD does not match the selected Voice or rhythm.	The currently assigned Voice or rhythm is displayed at the top of the LCD, and remains until another Voice or rhythm has been selected.
When keys are pressed, the sounds of percussion instruments are also heard.	The Keyboard Percussion function has been turned on. When not using the function, be sure to turn it off (page 68).
Even though a User button's rhythm has been selected and started, the pattern does not sound.	Since the User buttons contain User rhythms, no rhythm will sound if a pattern has not been saved to the selected User button.
EFFECTS	
The Touch Tone function does not operate.	Adjust the Touch Tone settings in the Voice Condition display (page 43).
The Reverb effect is not applied to the desired Voice sections, even when the REVERB button setting on the panel is increased.	Increase the Reverb depth for the desired Voice sections in Reverb display Pages 2 – 4.
The Rotary Speaker effect cannot be heard, even when the [ROTARY SP SPEED] button in the DISPLAY SELECT section is on.	Rotary Speaker must be selected first in Voice Condition display Pages 3 and/or 4 (for panel Voices), or in the Organ Flute Voices ATTACK/VOLUME Page (for Organ Flute Voices).
ACCOMPANIMENT	
The pitch in the Single Finger mode does not change, even when pressing different keys of the keyboard.	Single Finger mode will only produce notes when played within a fixed octave interval on the Lower keyboard. If notes with the same letter name are pressed outside of that range, the chords that are sounded will share the same pitch.
While an Intro/Ending pattern is automatically playing, the Lower keyboard does not produce any sound, even when the keys are played.	Since the Accompaniment chords play automatically one after another, the Lower keyboard is designed not to produce any sound during the playback of an Intro/Ending pattern.
The Accompaniment cannot be heard even when an appropriate Accompaniment type is selected and the rhythm has been started.	<ul style="list-style-type: none"> • The Accompaniment volume may have been set to 0. Be sure to raise the Accompaniment volume in the Rhythm Condition display (page 65). • All Accompaniment parts may be set to off (mute). Set the desired part on (page 65).
The harmony notes of the Melody On Chord function cannot be heard.	The Upper keyboard has been set to sound only Lead Voices. Increase the volume of the Upper Keyboard Voices.
The bass phrase of the Auto Bass Chord cannot be heard.	The pedal polyphonic mode may be set to on. Turn it off in the Voice Condition display (page 44).
REGISTRATION MEMORY	
Certain functions have not been memorized to Registration Memory.	Some functions cannot be memorized. Refer to page 95.
VOICE EDITING	
The Voice Edit display cannot be called up even when the [VOICE EDIT] button is pressed.	The Voice Edit display cannot be called up by pressing only the [VOICE EDIT] button. While holding down the [VOICE EDIT] button, press the desired Voice button.
During Voice editing, the specified Voice isn't heard, even when the keyboard is played.	<ul style="list-style-type: none"> • The Element is turned to mute or its level is set to minimum. Turn it to on or increase the volume. • You may have played keys outside the range of Note Limit. Play only keys within the Note Limit range.

Problem	Possible Cause and Solution
An error message appears while the Voice name is entered.	Voice name capacity is 16 characters. Delete the unnecessary letters or spaces.
RHYTHM PROGRAM	
During use of the Rhythm Pattern Program, no sound is produced even when you play a certain percussion sound.	If percussion sounds have been recorded while memory is full, no subsequently selected instruments can be heard or recorded. If necessary, erase some of the less necessary percussion sounds and play again.
MUSIC DATA RECORDER	
The USB flash drive is not recognized.	Check whether the connected USB flash drive is supported or not from the website below: http://download.yamaha.com/
Recording or playback cannot be performed.	<ul style="list-style-type: none"> • The part buttons in the Rec Standby display or Playing display may have been turned off. Turn the desired part to REC or PLAY. • The performance data is too large. The maximum limit for recording performance data is 1 MB.
Recording is stopped before the performance is finished.	<ul style="list-style-type: none"> • The amount of recorded data on the USB flash drive is close to the maximum limit. Either use another USB flash drive or delete the data of unnecessary Songs. • When you overwrite the Song, the length of a subsequently recorded part cannot exceed the length of the previously recorded parts. Delete the previously recorded Song, then record again (page 128) • The performance data is too large. The maximum limit for recording performance data is 1 MB.
An error message appears while entering a folder name or Song name.	<ul style="list-style-type: none"> • The folder/Song name is too long. The capacity is 50 letters. • The folder/Song name may be an invalid name. Refer to page 117. • The path name is too long. The capacity of the path name is 234 letters. Reduce the layer or shorten the folder/Song name to shorten the path.
The rhythm does not start at the beginning of a recording, or stops in the middle of the performance.	The MDR is designed so that the rhythm cannot be started at the very beginning of a recording. If you wish to use the rhythm, start it after the time indicator appears in the display.
The notes of the recording are "stuck" and sound continuously.	During playback, you may have removed the USB flash drive. Whenever you wish to stop playback, always press the [■] (Stop) button before removing the USB flash drive.

Specifications

	ELS-02	ELS-02C
TONE GENERATION	AWM	AWM/VA/ORGAN
KEYBOARD	Upper: 49 keys (C – C), Lower: 49 keys (C – C), Pedal: 20 keys (C – G)	
Keyboard Type	Standard (FS)	Custom (FSV)
Initial Touch	Upper, Lower, Pedal	
After Touch	Upper, Lower	Upper, Lower, Pedal
Horizontal Touch	—	Upper, Lower
REGISTRATIONS	Registration Menu	506
	Registration Memory	1 Unit 16 x 5 M. (Memory), 1 – 16, D. (Disable)
	Registration Shift	Shift, Jump, User (1 Unit: 400 steps), Next Unit
VOICE	Voice Sections	Upper 1, Upper 2, Lead 1, Lead 2, Lower 1, Lower 2, Pedal 1, Pedal 2
	Voice Buttons Upper/Lower	STRINGS, BRASS, WOODWIND, TUTTI, PAD, SYNTH, PIANO, ORGAN, PERCUSSION, GUITAR, CHOIR, WORLD, USER 1, USER 2
	Lead	VIOLIN, SYNTH, FLUTE, TRUMPET, USER 1, TO LOWER (Lead 1), SOLO (Lead 2)
	Pedal	VIOLIN, SYNTH, FLUTE, TRUMPET, VA-ACOUSTIC, VA-VIRTUAL, VA-ELECTRONIC, VA-CUSTOM, USER 1, TO LOWER (Lead 1), SOLO (Lead 2)
	CONTRABASS, ELEC. BASS, TIMPANI, SYNTH BASS, USER 1, TO LOWER	
	Preset Voices	AWM: 986
	User Voices	AWM: 80 (each Unit)
	Voice Link	Yes
	Organ Flute Voices	—
		Types: Sine, Vintage, Euro Footage: 16', 5 1/3', 8', 4', 2 2/3', 2', 1 3/5', 1 1/3', 1' Attack: 4', 2 2/3', 2', Length, Response Mode: First, Each Vibrato: Depth, Speed Effects: XG Rotary Sp, Rotary Sp 1 – 5, 2Way Rot Sp, Dual Rotsp 1 – 2, Dual Rot Brt, Dual Rot Wrm, Dist+Rot Sp, Odrv+Rot Sp, Amp+Rot Sp, Dist+2Rot Sp, Odrv+2Rot Sp, Amp+2Rot Sp, OFF
	Rotary Speaker Control	2.69 – 39.7 Hz, Slow, Stop
EFFECT/CONDITION	Sustain	Upper (KNEE), Lower (KNEE), Pedal
	Reverb (Voice Sections/Rhythm) Types	Hall 1 – 3, M, L, XG Hall 1 – 2, Room 1 – 4, S, M, L, XG Room 1 – 3, Stage 1 – 2, XG Stage 1 – 2, Plate 1 – 2, XG Plate, GM Plate, White Room, Atmo Hall, Acoustic Room, Drums Room, Perc Room, Tunnel, Canyon, Basement
	Depth	Upper 1 – 2, Lower 1 – 2, Lead 1 – 2, Pedal 1 – 2, Percussion, Accompaniment, Keyboard Percussion
		Upper 1 – 2, Lower 1 – 2, Lead 1 – 2, Pedal 1 – 2, Percussion, Accompaniment, Keyboard Percussion, Upper Organ Flute, Lower Organ Flute
	Voice Section Effects	Reverb, Delay, ER/Karaoke, Chorus, Flanger, Phaser, Tremolo/Auto Pan, Rotary Speaker, Distortion, Distortion+, Amp Simulator, Wah, Dynamic, EQ/Enhancer, Pitch Change, Miscellaneous, Thru
RHYTHMS	Rhythm Buttons	MARCH, WALTZ, SWING & JAZZ, POPS, R&B, LATIN, WORLD MUSIC, BALLAD, ROCK, DANCE, USER 1, USER 2
	Preset Rhythm Patterns	634 (including the metronome)
	Parts	Main Drum, Add Drum
	Sections	Intro 1 – 3, Ending 1 – 3, Main/Fill In A – D, Break, Auto Fill
ACCOMPANIMENT	Accompaniment Parts	Chord 1, Chord 2, Pad, Phrase1, Phrase 2
	Auto Bass Chord	OFF, Single Finger, Fingered Chord, Custom A.B.C. Memory: Lower, Pedal
	Melody On Chord	OFF, 1, 2, 3, Knee

		ELS-02	ELS-02C	
PROGRAMS	Voice Edit	Yes		
	Rhythm Pattern Program	Yes		
	Rhythm Sequence Program	1 Unit SEQ. 1 – 4 (Rhythm and Registration program)		
	Keyboard Percussion	1 Unit Preset 1 – 2, User 1 – 40 (Pan, Pitch coarse, Pitch fine, Reverb, Volume)		
CONTROLS	Footswitch	Left	Rhythm: Stop, Break, Main A – D, Intro 1 – 3, Ending 1 – 3 Glide: Upper 1, 2, Lower 1, 2, Lead 1, 2, Glide Time Rotary Speaker	
		Right	Registration Shift	
	Expression Pedal	Yes		
	2nd Expression Pedal	Pitch Bend, Tempo (set only, not controlled)	Pitch Bend, Tempo	
	Knee Lever	Sustain (Upper/Lower), M.O.C., Lead Slide, Solo (Lead 2)		
	Transpose	-6 – +6		
	Pitch	A = 427.2 – 452.6 Hz, Default value: A = 440 Hz		
	MIDI Control	Yes		
	Main Controls	POWER on/off, MASTER VOLUME		
	MDR	Search, Song Select: Stop, Play, Pause, Rewind, Fast Forward, Record, Custom Play, Score, Setting (Tempo/Part), Unit Edit Tools: Create Folder, Change Song Name, Copy, Delete, Conversion (XG/EL/ELS format), Format, Information		
	Audio Recording/Playback	Play: Stop, Play, Pause, Rewind, Fast Forward, Volume, Tempo, Pitch Record: Stop, Record Tools: Create Folder, Change Name, Copy, Delete, Format, Information File Format: .wav (44.1kHz, 16bit, stereo)		
	Utility	Language (English/Japanese), Touch Panel Sound, LCD Brightness, Mic. (Reverb/Volume), Disable Mode (Normal/Tempo), Initialize		
	Display Select	VOICE DISPLAY, A.B.C./M.O.C., MDR, FOOTSWITCH, UTILITY, AUDIO, VOICE EDIT, RHYTHM PATTERN PROGRAM, RHYTHM SEQUENCE PROGRAM, ROTARY SP SPEED	VOICE DISPLAY, A.B.C./M.O.C., MDR, FOOTSWITCH, UTILITY, AUDIO, VOICE EDIT, RHYTHM PATTERN PROGRAM, RHYTHM SEQUENCE PROGRAM, U. ORGAN FLUTES, L. ORGAN FLUTES, ROTARY SP SPEED	
	OTHERS	Display	Type	TFT Color Wide VGA LCD
Size			800 x 480 dots 7 inch	
Sound System		Power Amplifiers (According to measurement method specified by Yamaha)	50W x 2	70W x 2
		Speakers	Cone: 13 cm x 2, 5 cm x 2 Monitor speaker: 6.6 cm x 2	Cone: 13 cm x 8 Dome: 2.5 cm x 4 Monitor speaker: 6.6 cm x 2
Storage		USB flash drive		
Connectors		PHONES (2), AUX OUT: L/L+R, R (standard phone), L, R (Level Fixed: RCA), AUX IN: L/L+R, R (standard phone), MIDI IN/OUT, USB TO HOST, USB TO DEVICE (3; two terminals have been connected to the USB Dock), MIC./LINE IN (jack, switch, and volume control)		
Dimensions (W x D x H), Weight			1229 x 574 x 1017 (1276 with Music Rest) mm, 102.5 kg	1229 x 574 x 1017 (1276 with Music Rest) mm, 109.5 kg
		Bench	781 x 305 x 618 mm, 8.8 kg	
Color		Silver Metallic		
Supplied Accessories		Bench, Owner's Manual, Online Member Product Registration		

*The contents of this manual apply to the latest specifications as of the publishing date. To obtain the latest manual, access the Yamaha website then download the manual file. Since specifications, equipment or separately sold accessories may not be the same in every locale, please check with your Yamaha dealer.

Index

Numerics

2nd Expression Pedal 182

A

A.B.C./M.O.C. 66, 67
 ACCENT 152
 Accompaniment 65
 Ad Hoc Mode 197
 Add Drum 65
 AEM 7
 AFTER touch (Pitch) 44
 AFTER touch (Touch Tone) 43
 AMP SIMULATOR 55
 ARTICULATION 45
 ASSEMBLE 149
 ATTACK (Organ Flutes) 40
 ATTACK RATE (Voice Edit) 141, 143
 Audio 132
 Audio Recording 132
 Auto Bass Chord 66
 Auto Fill 58
 AUX IN 186
 AUX OUT 186
 AUX OUT (LEVEL FIXED) 186
 AWM (Voice Edit) 140
 AWM Voice 39

B

Bank 98
 BAR/BEAT 59
 BREAK 57
 BRILLIANCE (Panel) 48

C

CHANGE NAME (Song) 116
 CHORD 1 65
 CHORD 2 65
 CHORUS (Effect) 54
 CHORUS (Rhythm Pattern Program) .. 159
 Computer 191
 CONVERT EL TO ELS 131
 CONVERT ELS TO EL 130
 CONVERT TO XG 129
 CUSTOM A.B.C. 67
 CUTOFF FREQ. 141

D

[D.] (Disable) 96
 DATA CONTROL dial 12
 DECAY RATE 143
 DELAY (Effect) 54
 DELAY (Vibrato) 44
 DEPTH (Reverb) 46
 DEPTH (Vibrato) 44
 Display Select 12

DISTORTION 54
 DYNAMIC 55

E

EACH (Organ Flutes) 40
 EFFECT 45
 Effect category (Voice) 45
 Effect Parameters 46
 EFFECT TYPE (Organ Flutes) 41
 Effect type (Voice) 45
 Element 138
 ENDING 57, 58
 Envelope Parameters 143
 EQ (Equalizer) 140, 143
 EQ/ENHANCER (Effect) 55
 ER/KARAOKE 54
 Expression pedal 13
 EXTERNAL 192

F

Factory Set 23
 Fast forward 122
 FEET 44
 File 109
 FILL IN 57
 Filter 141
 FINGERED CHORD 66
 FIRST (Organ Flutes) 40
 FLANGER 54
 Folder 109
 FOOT SWITCH 99, 178
 FOOTAGE 40
 Footswitch 178
 FORMAT (MDR) 111

G

Gate Time 157
 Glide 179

H

Headphones 187
 HORIZONTAL touch 43

I

Infrastructure Mode 194
 INITIAL touch 43
 Initialize (Factory Set) 23
 Initialize (Registration Memory) 98
 Initialize (Wireless LAN settings) 200
 INPUT VOLUME 185
 INTERNAL 192
 INTRO 58

J

Jacks and Controls 185
 JUMP 99

K

Keyboard Percussion 68
 Knee Lever 180

L

L. ORGAN FLUTE 40
 LANGUAGE 16
 LAST (Lead Voice) 44
 LAYER (Voice Edit) 140
 LCD BRIGHTNESS 17
 LCD Display 12
 Lead Slide 45
 Lead Voice 24
 LEAD VOICE (Panel) 11
 LEVEL (Voice Edit) 141, 143
 LFO (Low Frequency Oscillator) 142
 Lower Keyboard Voice 24
 LOWER KEYBOARD VOICE (Panel) 10

M

[M.] (Memory) 95
 M.O.C. 67
 MAIN 57
 Main Drum 65
 MASTER VOLUME 13
 MDR 106
 Melody On Chord 67
 MEMORY (A.B.C.) 67
 METRONOME 149
 MIC./LINE IN jack 185
 MIC./LINE switch 185
 MIDI Control 192
 MIDI IN/OUT 187
 MIDI OUT FILTER 192
 MISCELLANEOUS 55
 MODE (Organ Flutes) 40
 MODE (Rotary Speaker) 49
 Music Data Recorder 106

N

Next Page 125
 Next Unit 119
 NEXT UNIT (Shift End) 100
 NOTE LIMIT 141
 NOTE SHIFT 141

O

Organ Flutes 40
 OUTPUT (MIDI) 192

- P**
- PAD 65
 - PAN (Voice Edit) 141
 - PAN (Voice) 43
 - Part (Rhythm) 65
 - PATTERN 146
 - Pause 122
 - Pedal polyphonic mode 44
 - Pedal Voice 25
 - PEDAL VOICE (Panel) 11
 - PHASER 54
 - PHONES 185
 - PHRASE 1 65
 - PHRASE 2 65
 - Pitch 184
 - PITCH (Voice section) 43
 - Pitch Bend 183
 - PITCH CHANGE 55
 - Playback 121
 - POLY 44
 - Power switch 13
 - PRESET (Vibrato) 44
 - Preset Keyboard Percussion 68
 - PRESET TEMPO 60
 - PRIORITY 44
 - Protected Song 121
 - Punch-in Recording 116
- Q**
- Quantize 155
- R**
- Real Time Write 150, 155
 - Recording (Audio) 132
 - Recording (Lead Voice 1 Voice only) .. 115
 - Recording (MDR) 114
 - Recording (Part) 115
 - Registration Memory 95
 - REGISTRATION MENU 19
 - Registration Sequence 174
 - Registration Shift 99
 - RELEASE RATE (Voice Edit) 141, 143
 - Remaining Memory Capacity 162
 - Repeat 123
 - Re-recording (Retry) 114
 - RESONANCE 141
 - RESP. (Response) 40
 - Reverb 46
 - REVERB (MIC.) 189
 - REVERB (Panel) 46
 - REVERB (Rhythm Pattern Program) ... 159
 - Rewind 122
 - Rhythm 56
 - Rhythm button 56
 - Rhythm Clock 152
 - Rhythm Condition 58
 - Rhythm Menu 56
 - Rhythm Pattern Program 146
 - Rhythm Program 146
 - Rhythm Sequence Program 172
 - Rhythmic Chord 156
 - ROTARY SP SPEED 49
 - Rotary Speaker 49
- S**
- SCORE 124
 - Section 57
 - SEQUENCE 172
 - SETTINGS (MDR) 112
 - SHIFT (Registration Shift) 99
 - SHIFT END 100
 - SINGLE FINGER 66
 - SLIDE 45
 - SLOW (Rotary Speaker) 49
 - SOLO 27
 - Song 109, 112
 - Song Copy 126
 - Song Delete 128
 - Specifications 204
 - SPEED (Rotary Speaker) 49
 - SPEED (Vibrato) 45
 - START 57
 - Step Write 150
 - STOP (Rotary Speaker) 49
 - STOP (Shift End) 100
 - Style File Format 163
 - Super Articulation Voice 39
 - Sustain 48
 - SUSTAIN (Panel) 48
 - SYNCHRO START 57
- T**
- Tempo (MDR) 123
 - TEMPO (Rhythm) 59
 - THRU (Effect) 55
 - TIME (Slide) 45
 - TO LOWER 27
 - TOP 44
 - TOP (Lead Voice) 44
 - TOP (Shift End) 100
 - TOUCH PANEL SOUND 16
 - TOUCH TONE 43
 - TOUCH VIBRATO 45
 - Transpose 184
 - TRANSPOSE (Voice section) 46
 - TREMOLO/AUTO PAN 54
 - TUNE (Voice section) 46
 - TUNE FINE (Voice Edit) 141
- U**
- U. ORGAN FLUTES 40
 - Unit 98
 - UNIT EDIT (MDR) 118
 - Upper Keyboard Voice 24
 - UPPER KEYBOARD VOICE (Panel) 10
 - USB Dock 110, 186
 - USB flash drive 110
 - USB TO DEVICE 110, 187
 - USB TO HOST 187
 - USER (Registration Shift) 99
 - USER (Vibrato) 44
 - User button (Rhythm) 60
 - User button (Voice) 28
 - User Keyboard Percussion 81
 - User Rhythm 161
 - User Voice 144
 - UTILITY 16
- V**
- VA (Voice Edit) 143
 - VA Custom Voice 144
 - VA Voice 39
 - VARIATION (Rhythm Pattern Program) 160
 - Version 23
 - VIBRATO 44
 - VIBRATO (Organ Flutes) 41
 - Voice 24
 - Voice button 25
 - Voice Condition 26, 43
 - VOICE DISPLAY 17
 - Voice Edit 138
 - VOICE EDIT (Panel) 139
 - Voice Link 43, 50
 - Voice Menu 25
 - Voice section 24
 - Volume (Accompaniment) 65
 - Volume (Keyboard Percussion) 69
 - VOLUME (MIC.) 189
 - VOLUME (Organ Flutes) 41
 - VOLUME (Rhythm Pattern Program) .. 159
 - VOLUME (Rhythm) 59
 - VOLUME (Voice) 26
- W**
- WAH 55
 - Wireless LAN settings 193
 - WPS 194
- X**
- XG 7

About Using BSD-Licensed Software

The software used by this product includes components that comply with the BSD license.

The restrictions placed on users of software released under a typical BSD license are that if they redistribute such software in any form, with or without modification, they must include in the redistribution (1) a disclaimer of liability, (2) the original copyright notice and (3) a list of licensing provisions.

The following contents are displayed based on the licensing conditions described above, and do not govern your use of the product.

WPA Supplicant

Copyright © 2003-2009, Jouni Malinen <j@w1.fi> and contributors
All Rights Reserved.

This program is dual-licensed under both the GPL version 2 and BSD license. Either license may be used at your option.

License

Redistribution and use in source and binary forms, with or without modification, are permitted provided that the following conditions are met:

1. Redistributions of source code must retain the above copyright notice, this list of conditions and the following disclaimer.
2. Redistributions in binary form must reproduce the above copyright notice, this list of conditions and the following disclaimer in the documentation and/or other materials provided with the distribution.
3. Neither the name(s) of the above-listed copyright holder(s) nor the names of its contributors may be used to endorse or promote products derived from this software without specific prior written permission.

THIS SOFTWARE IS PROVIDED BY THE COPYRIGHT HOLDERS AND CONTRIBUTORS "AS IS" AND ANY EXPRESS OR IMPLIED WARRANTIES, INCLUDING, BUT NOT LIMITED TO, THE IMPLIED WARRANTIES OF MERCHANTABILITY AND FITNESS FOR A PARTICULAR PURPOSE ARE DISCLAIMED. IN NO EVENT SHALL THE COPYRIGHT OWNER OR CONTRIBUTORS BE LIABLE FOR ANY DIRECT, INDIRECT, INCIDENTAL, SPECIAL, EXEMPLARY, OR CONSEQUENTIAL DAMAGES (INCLUDING, BUT NOT LIMITED TO, PROCUREMENT OF SUBSTITUTE GOODS OR SERVICES; LOSS OF USE, DATA, OR PROFITS; OR BUSINESS INTERRUPTION) HOWEVER CAUSED AND ON ANY THEORY OF LIABILITY, WHETHER IN CONTRACT, STRICT LIABILITY, OR TORT (INCLUDING NEGLIGENCE OR OTHERWISE) ARISING IN ANY WAY OUT OF THE USE OF THIS SOFTWARE, EVEN IF ADVISED OF THE POSSIBILITY OF SUCH DAMAGE.

XySSL

Copyright © 2006-2008, Christophe Devine.
All rights reserved.

Redistribution and use in source and binary forms, with or without modification, are permitted provided that the following conditions are met:

- * Redistributions of source code must retain the above copyright notice, this list of conditions and the following disclaimer.
- * Redistributions in binary form must reproduce the above copyright notice, this list of conditions and the following disclaimer in the documentation and/or other materials provided with the distribution.
- * Neither the name of XySSL nor the names of its contributors may be used to endorse or promote products derived from this software without specific prior written permission.

THIS SOFTWARE IS PROVIDED BY THE COPYRIGHT HOLDERS AND CONTRIBUTORS "AS IS" AND ANY EXPRESS OR IMPLIED WARRANTIES, INCLUDING, BUT NOT LIMITED TO, THE IMPLIED WARRANTIES OF MERCHANTABILITY AND FITNESS FOR A PARTICULAR PURPOSE ARE DISCLAIMED. IN NO EVENT SHALL THE COPYRIGHT OWNER OR CONTRIBUTORS BE LIABLE FOR ANY DIRECT, INDIRECT, INCIDENTAL, SPECIAL, EXEMPLARY, OR CONSEQUENTIAL DAMAGES (INCLUDING, BUT NOT LIMITED TO, PROCUREMENT OF SUBSTITUTE GOODS OR SERVICES; LOSS OF USE, DATA, OR PROFITS; OR BUSINESS INTERRUPTION) HOWEVER CAUSED AND ON ANY THEORY OF LIABILITY, WHETHER IN CONTRACT, STRICT LIABILITY, OR TORT (INCLUDING NEGLIGENCE OR OTHERWISE) ARISING IN ANY WAY OUT OF THE USE OF THIS SOFTWARE, EVEN IF ADVISED OF THE POSSIBILITY OF SUCH DAMAGE.

For details of products, please contact your nearest Yamaha representative or the authorized distributor listed below.

Pour plus de détails sur les produits, veuillez-vous adresser à Yamaha ou au distributeur le plus proche de vous figurant dans la liste suivante.

Die Einzelheiten zu Produkten sind bei Ihrer unten aufgeführten Niederlassung und bei Yamaha Vertragshändlern in den jeweiligen Bestimmungsländern erhältlich.

Para detalles sobre productos, contacte su tienda Yamaha más cercana o el distribuidor autorizado que se lista debajo.

NORTH AMERICA

CANADA

Yamaha Canada Music Ltd.
135 Milner Avenue, Toronto, Ontario M1S 3R1,
Canada
Tel: +1-416-298-1311

U.S.A.

Yamaha Corporation of America
6600 Orangethorpe Avenue, Buena Park, CA 90620,
U.S.A.
Tel: +1-714-522-9011

CENTRAL & SOUTH AMERICA

MEXICO

Yamaha de México, S.A. de C.V.
Av. Insurgentes Sur 1647 Piso 9, Col. San José
Insurgentes, Delegación Benito Juárez, México,
D.F., C.P. 03900
Tel: +52-55-5804-0600

BRAZIL

Yamaha Musical do Brasil Ltda.
Rua Fidêncio Ramos, 302 – Cj 52 e 54 – Torre B –
Vila Olímpia – CEP 04551-010 – São Paulo/SP,
Brazil
Tel: +55-11-3704-1377

ARGENTINA

**Yamaha Music Latin America, S.A.,
Sucursal Argentina**
Olga Cossettini 1553, Piso 4 Norte,
Madero Este-C1107CEK,
Buenos Aires, Argentina
Tel: +54-11-4119-7000

VENEZUELA

Yamaha Musical de Venezuela, C.A.
AV. Manzanares, C.C. Manzanares Plaza,
Piso 4, Oficina 0401, Baruta, Caracas, Venezuela
Tel: +58-212-943-1877

PANAMA AND OTHER LATIN

AMERICAN COUNTRIES/ CARIBBEAN COUNTRIES

Yamaha Music Latin America, S.A.
Edif. Torre Banco General, F7, Urb. Marbella,
Calle 47 y Aquilino de la Guardia, Panama,
P.O.Box 0823-05863, Panama, Rep.de Panama
Tel: +507-269-5311

EUROPE

THE UNITED KINGDOM/IRELAND

Yamaha Music Europe GmbH (UK)
Sherbourne Drive, Tilbrook, Milton Keynes,
MK7 8BL, U.K.
Tel: +44-1908-366700

GERMANY

Yamaha Music Europe GmbH
Siemensstrasse 22-34, 25462 Rellingen, Germany
Tel: +49-4101-303-0

SWITZERLAND/LIECHTENSTEIN

**Yamaha Music Europe GmbH, Rellingen,
Branch Switzerland in Zürich**
Seefeldstrasse 94, 8008 Zürich, Switzerland
Tel: +41-44-3878080

AUSTRIA

Yamaha Music Europe GmbH, Branch Austria
Schleiergasse 20, 1100 Wien, Austria
Tel: +43-1-60203900

CZECH REPUBLIC/HUNGARY/ ROMANIA/SLOVAKIA/SLOVENIA

Yamaha Music Europe GmbH, Branch Austria
Schleiergasse 20, 1100 Wien, Austria
Tel: +43-1-60203900

POLAND/LITHUANIA/LATVIA/ ESTONIA

Yamaha Music Europe GmbH
Sp.z o.o. Oddzial w Polsce
ul. Wrotkowa 14, 02-553 Warsaw, Poland
Tel: +48-22-880-08-88

BULGARIA

Dinacord Bulgaria LTD.
Bul. Iskarsko Schose 7 Targowski Zentar Ewropa
1528 Sofia, Bulgaria
Tel: +359-2-978-20-25

MALTA

Olimpus Music Ltd.
Valletta Road, Mosta MST9010, Malta
Tel: +356-2133-2093

NETHERLANDS/BELGIUM/ LUXEMBOURG

Yamaha Music Europe, Branch Benelux
Clarissenhof 5b, 4133 AB Vianen, The Netherlands
Tel: +31-347-358040

FRANCE

Yamaha Music Europe
7 rue Ambroise Croizat, Zone d'activités de Pariest,
77183 Croissy-Beaubourg, France
Tel: +33-1-6461-4000

ITALY

Yamaha Music Europe GmbH, Branch Italy
Viale Italia 88, 20020, Lainate (Milano), Italy
Tel: +39-02-93577-1

SPAIN/PORTUGAL

**Yamaha Music Europe GmbH Ibérica, Sucursal
en España**
Ctra. de la Coruna km. 17,200, 28231
Las Rozas de Madrid, Spain
Tel: +34-91-639-88-88

GREECE

Philippos Nakas S.A. The Music House
19th klm. Leof. Lavriou 190 02 Peania – Attiki,
Greece
Tel: +30-210-6686260

SWEDEN

**Yamaha Music Europe GmbH Germany filial
Scandinavia**
JA Wettergrensgata 1, 400 43 Göteborg, Sweden
Tel: +46-31-89-34-00

DENMARK

**Yamaha Music Denmark,
Filiat of Yamaha Music Europe GmbH, Tyskland**
Generatorvej 8C, ST. TH., 2860 Søborg, Denmark
Tel: +45-44-92-49-00

FINLAND

F-Musiikki Oy
Antaksentie 4
FI-01510 Vantaa, Finland
Tel: +358 (0)96185111

NORWAY

**Yamaha Music Europe GmbH Germany -
Norwegian Branch**
Grini Næringspark 1, 1332 Østerås, Norway
Tel: +47-6716-7800

ICELAND

Hljóðfaerahusid Ehf.
Sidumula 20
IS-108 Reykjavik, Iceland
Tel: +354-525-5050

CROATIA

Euro Unit D.O.O.
Slakovec 73
40305 Nedelisce
Tel: +38540829400

RUSSIA

Yamaha Music (Russia) LLC.
Room 37, entrance 7, bld. 7, Kievskaya street,
Moscow, 121059, Russia
Tel: +7-495-626-5005

OTHER EUROPEAN COUNTRIES

Yamaha Music Europe GmbH
Siemensstrasse 22-34, 25462 Rellingen, Germany
Tel: +49-4101-303-0

AFRICA

Yamaha Music Gulf FZE
JAFZA-16, Office 512, P.O.Box 17328,
Jebel Ali FZE, Dubai, UAE
Tel: +971-4-801-1500

MIDDLE EAST

TURKEY

Yamaha Music Europe GmbH
Merkezi Almanya Türkiye İstanbul Şubesi
Maslak Meydan Sodak, Spring Giz Plaza Bagimsiz
Böl. No:3, Sariyer Istanbul, Turkey
Tel: +90-212-999-8010

CYPRUS

Nakas Music Cyprus Ltd.
Nikis Ave 2k
1086 Nicosia
Tel: + 357-22-511080
Major Music Center
21 Ali Riza Ave. Ortakoy
P.O.Box 475 Nicosia, Cyprus
Tel: (392) 227 9213

OTHER COUNTRIES

Yamaha Music Gulf FZE
JAFZA-16, Office 512, P.O.Box 17328,
Jebel Ali FZE, Dubai, UAE
Tel: +971-4-801-1500

ASIA

THE PEOPLE'S REPUBLIC OF CHINA

Yamaha Music & Electronics (China) Co., Ltd.
2F, Yunhedasha, 1818 Xinzha-lu, Jingan-qu,
Shanghai, China
Tel: +86-400-051-7700

HONG KONG

Tom Lee Music Co., Ltd.
11/F., Silvercord Tower 1, 30 Canton Road,
Tsimshatsui, Kowloon, Hong Kong
Tel: +852-2737-7688

INDIA

Yamaha Music India Private Limited
Spazedge Building, Ground Floor, Tower A,
Sector-47, Gurgaon- Sohna Road, Gurgaon-122002,
Haryana, India
Tel: +91-124-485-3300

INDONESIA

PT. Yamaha Musik Indonesia (Distributor)
Yamaha Music Center Bldg. Jalan Jend. Gatot
Subroto Kav. 4, Jakarta 12930, Indonesia
Tel: +62-21-520-2577

KOREA

Yamaha Music Korea Ltd.
8F, Dongsung Bldg. 21, Teheran-ro 87-gil,
Gangnam-gu, Seoul, 135-880, Korea
Tel: +82-2-3467-3300

MALAYSIA

Yamaha Music (Malaysia) Sdn. Bhd.
No.8, Jalan Perbandaran, Kelana Jaya, 47301
Petaling Jaya, Selangor, Malaysia
Tel: +60-3-78030900

SINGAPORE

Yamaha Music (Asia) Private Limited
Block 202 Hougang Street 21, #02-00,
Singapore 530202, Singapore
Tel: +65-6740-9200

TAIWAN

Yamaha Music & Electronics Taiwan Co., Ltd.
2F., No.1, Yuandong Rd. Banqiao Dist.
New Taipei City 22063, Taiwan, R.O.C.
Tel: +886-2-7741-8888

THAILAND

Siam Music Yamaha Co., Ltd.
3, 4, 15, 16th Fl., Siam Motors Building,
891/1 Rama 1 Road, Wangmai,
Pathumwan, Bangkok 10330, Thailand
Tel: +66-2215-2622

VIETNAM

Yamaha Music Vietnam Company Limited
15th Floor, Nam A Bank Tower, 201-203 Cach
Mang Thang Tam St., Ward 4, Dist.3,
Ho Chi Minh City, Vietnam
Tel: +84-8-3818-1122

OTHER ASIAN COUNTRIES

<http://asia.yamaha.com>

OCEANIA

AUSTRALIA

Yamaha Music Australia Pty. Ltd.
Level 1, 99 Queensbridge Street, Southbank,
VIC 3006, Australia
Tel: +61-3-9693-5111

NEW ZEALAND

Musics Works LTD
P.O.BOX 6246 Wellesley, Auckland 4680,
New Zealand
Tel: +64-9-634-0099

COUNTRIES AND TRUST TERRITORIES IN PACIFIC OCEAN

<http://asia.yamaha.com>

MEMO

MEMO



ZV66270

Yamaha Downloads
<http://download.yamaha.com/>

Manual Development Group
© 2016 Yamaha Corporation

Published 2016/07 MWTO-D0
Printed in Japan

ZV66270