

STAGE BOX

SB168-ES

Owner's Manual
Bedienungsanleitung
Mode d'emploi
Manual de instrucciones
Manuale di istruzioni
Руководство пользователя
使用说明书
取扱説明書

English

Deutsch

Français

Español

Italiano

Русский

中文

日本語

EN
DE
FR
ES
IT
RU
ZH
JA

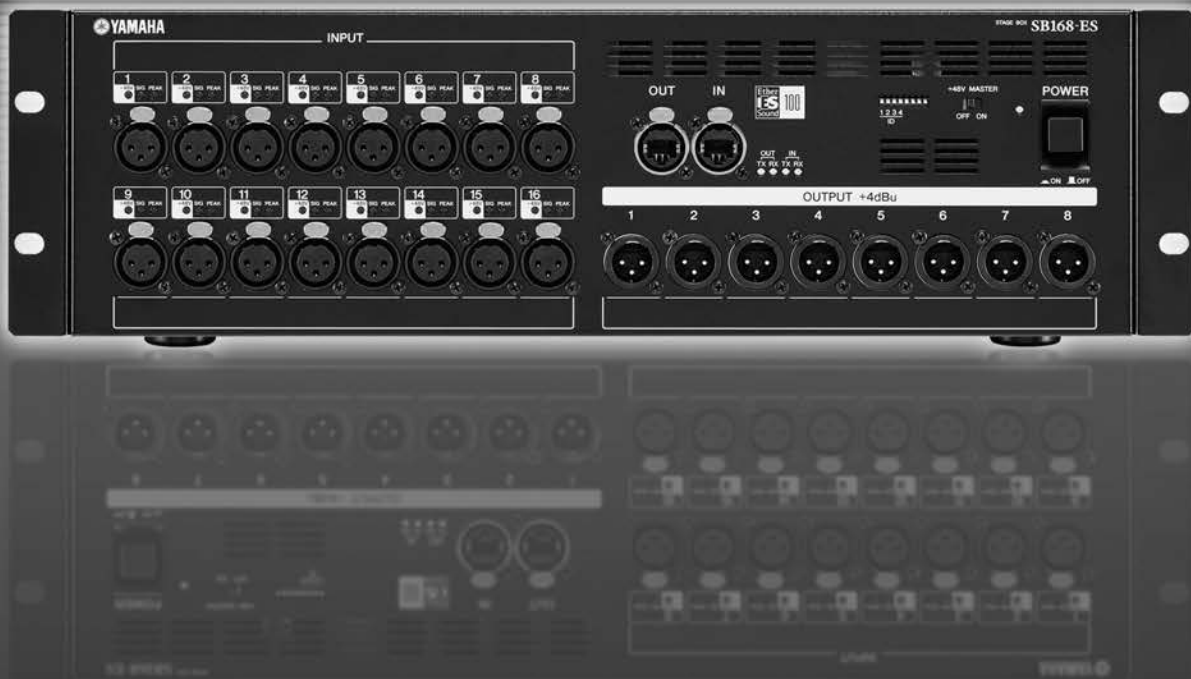

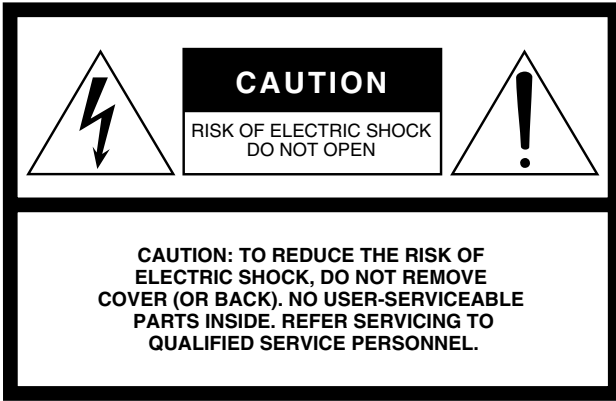

Explanation of Graphical Symbols

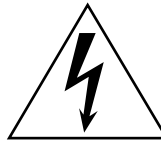

The lightning flash with arrowhead symbol within an equilateral triangle is intended to alert the user to the presence of uninsulated “dangerous voltage” within the product’s enclosure that may be of sufficient magnitude to constitute a risk of electric shock to persons.



The exclamation point within an equilateral triangle is intended to alert the user to the presence of important operating and maintenance (servicing) instructions in the literature accompanying the product.

The top half of the above warning is located on the top or rear of the unit.

IMPORTANT SAFETY INSTRUCTIONS

- 1 Read these instructions.
- 2 Keep these instructions.
- 3 Heed all warnings.
- 4 Follow all instructions.
- 5 Do not use this apparatus near water.
- 6 Clean only with dry cloth.
- 7 Do not block any ventilation openings. Install in accordance with the manufacturer’s instructions.
- 8 Do not install near any heat sources such as radiators, heat registers, stoves, or other apparatus (including amplifiers) that produce heat.
- 9 Do not defeat the safety purpose of the polarized or grounding-type plug. A polarized plug has two blades with one wider than the other. A grounding type plug has two blades and a third grounding prong. The wide blade or the third prong are provided for your safety. If the provided plug does not fit into your outlet, consult an electrician for replacement of the obsolete outlet.
- 10 Protect the power cord from being walked on or pinched particularly at plugs, convenience receptacles, and the point where they exit from the apparatus.
- 11 Only use attachments/accessories specified by the manufacturer.
- 12 Use only with the cart, stand, tripod, bracket, or table specified by the manufacturer, or sold with the apparatus. When a cart is used, use caution when moving the cart/apparatus combination to avoid injury from tip-over.
- 13 Unplug this apparatus during lightning storms or when unused for long periods of time.
- 14 Refer all servicing to qualified service personnel. Servicing is required when the apparatus has been damaged in any way, such as power-supply cord or plug is damaged, liquid has been spilled or objects have fallen into the apparatus, the apparatus has been exposed to rain or moisture, does not operate normally, or has been dropped.



WARNING

TO REDUCE THE RISK OF FIRE OR ELECTRIC SHOCK, DO NOT EXPOSE THIS APPARATUS TO RAIN OR MOISTURE.

(UL60065_03)

PRECAUTIONS

PLEASE READ CAREFULLY BEFORE PROCEEDING

* Please keep this manual in a safe place for future reference.



WARNING

Always follow the basic precautions listed below to avoid the possibility of serious injury or even death from electrical shock, short-circuiting, damages, fire or other hazards. These precautions include, but are not limited to, the following:

Power supply/Power cord

- Only use the voltage specified as correct for the device. The required voltage is printed on the name plate of the device.
- Use only the included power cord.
If you intend to use the device in an area other than in the one you purchased, the included power cord may not be compatible. Please check with your Yamaha dealer.
- Do not place the power cord near heat sources such as heaters or radiators, and do not excessively bend or otherwise damage the cord, place heavy objects on it, or place it in a position where anyone could walk on, trip over, or roll anything over it.
- Be sure to connect to an appropriate outlet with a protective grounding connection. Improper grounding can result in electrical shock.

Do not open

- Do not open the device or attempt to disassemble the internal parts or modify them in any way. The device contains no user-serviceable parts. If it should appear to be malfunctioning, discontinue use immediately and have it inspected by qualified Yamaha service personnel.

Water warning

- Do not expose the device to rain, use it near water or in damp or wet conditions, or place containers on it containing liquids which might spill into any openings. If any liquid such as water seeps into the device, turn off the power immediately and unplug the power cord from the AC outlet. Then have the device inspected by qualified Yamaha service personnel.
- Never insert or remove an electric plug with wet hands.

If you notice any abnormality

- If the power cord or plug becomes frayed or damaged, or if there is a sudden loss of sound during use of the device, or if any unusual smells or smoke should appear to be caused by it, immediately turn off the power switch, disconnect the electric plug from the outlet, and have the device inspected by qualified Yamaha service personnel.
- If this device should be dropped or damaged, immediately turn off the power switch, disconnect the electric plug from the outlet, and have the device inspected by qualified Yamaha service personnel.



CAUTION

Always follow the basic precautions listed below to avoid the possibility of physical injury to you or others, or damage to the device or other property. These precautions include, but are not limited to, the following:

Power supply/Power cord

- Remove the electric plug from the outlet when the device is not to be used for extended periods of time, or during electrical storms.
- When removing the electric plug from the device or an outlet, always hold the plug itself and not the cord. Pulling by the cord can damage it.

Location

- Before moving the device, remove all connected cables.
- When setting up the device, make sure that the AC outlet you are using is easily accessible. If some trouble or malfunction occurs, immediately turn off the power switch and disconnect the plug from the outlet. Even when the power switch is turned off, electricity is still flowing to the product at the minimum level. When you are not using the product for a long time, make sure to unplug the power cord from the wall AC outlet.
- If this device is to be mounted in an EIA-standard rack, carefully read the section "Precautions for Rack Mounting" on page 7 before setting up the device. Inadequate ventilation can result in overheating, possibly causing damage to the device(s), or even fire.

- Do not expose the device to excessive dust or vibrations, or extreme cold or heat (such as in direct sunlight, near a heater, or in a car during the day) to prevent the possibility of panel disfiguration or damage to the internal components.
- Do not place the device in an unstable position where it might accidentally fall over.
- Do not block the vents. This device has ventilation holes at the front and rear to prevent the internal temperature from becoming too high. In particular, do not place the device on its side or upside down. Inadequate ventilation can result in overheating, possibly causing damage to the device(s), or even fire.
- Do not use the device in the vicinity of a TV, radio, stereo equipment, mobile phone, or other electric devices. Doing so may result in noise, both in the device itself and in the TV or radio next to it.
- Do not place the device in a location where it may come into contact with corrosive gases or salt air. Doing so may result in malfunction.

Connections

- Before connecting the device to other devices, turn off the power for all devices. Before turning the power on or off for all devices, set all volume levels to minimum.

Handling caution

- When turning on the AC power in your audio system, always turn on the power amplifier LAST, to avoid speaker damage. When turning the power off, the power amplifier should be turned off FIRST for the same reason.
- Condensation can occur in the device due to rapid, drastic changes in ambient temperature – when the device is moved from one location to another, or air conditioning is turned on or off, for example. Using the device while condensation is present can cause damage. If there is reason to believe that condensation might have occurred, leave the device for several hours without turning on the power until the condensation has completely dried out.
- Do not insert your fingers or hands in any gaps or openings on the device (vents, etc.).
- Avoid inserting or dropping foreign objects (paper, plastic, metal, etc.) into any gaps or openings on the device (vents, etc.) If this happens, turn off the power immediately and unplug the power cord from the AC outlet. Then have the device inspected by qualified Yamaha service personnel.
- Do not use the device for a long period of time at a high or uncomfortable volume level, since this can cause permanent hearing loss. If you experience any hearing loss or ringing in the ears, consult a physician.
- Do not rest your weight on the device or place heavy objects on it, and avoid use excessive force on the buttons, switches or connectors.

Backup battery

- This device has a built-in backup battery that maintains data in internal memory even when the device's power is switched off. The backup battery will eventually become depleted, however, and when that happens the contents of the internal memory will be lost.* To prevent loss of data be sure to replace the backup battery before it becomes fully depleted. Imminent battery depletion is indicated by the panel LEDs, as described on page 21. In this case, immediately save the data to a compatible digital mixer, then have qualified Yamaha service personnel replace the backup battery. The average life of the internal backup battery is approximately 5 years, depending on operating conditions.
 - * Data items maintained in the internal memory by the backup battery are as follows:
 - internal head amplifier settings

XLR-type connectors are wired as follows (IEC60268 standard): pin 1: ground, pin 2: hot (+), and pin 3: cold (-).

Yamaha cannot be held responsible for damage caused by improper use or modifications to the device, or data that is lost or destroyed.

Always turn the power off when the device is not in use.

The performance of components with moving contacts, such as switches, and connectors, deteriorates over time. Consult qualified Yamaha service personnel about replacing defective components.

European models

Purchaser/User Information specified in EN55103-1 and EN55103-2.

Inrush Current: 50A

Conforms to Environments: E1, E2, E3 and E4

- The illustrations as shown in this manual are for instructional purposes only, and may be different from the ones on your equipment.
- EtherSound is a registered trademark of Digigram S.A.
- The company names and product names in this manual are the trademarks or registered trademarks of their respective companies.

* Specifications and descriptions in this owner's manual are for information purposes only. Yamaha Corp. reserves the right to change or modify products or specifications at any time without prior notice. Since specifications, equipment or options may not be the same in every locale, please check with your Yamaha dealer.

Contents

Foreword	6
SB168-ES Features.....	6
Firmware Updates	6
Connecting the AC Power Cable	6
Powering ON or OFF	7
Precautions for Rack Mounting.....	7
Recessed installation.....	7
Resetting the Unit to Initial Factory Condition (Initialization)	7
About EtherSound	8
EtherSound is	8
Daisy Chain and Ring Networks	8
Controls and Functions	10
Front Panel	10
Rear Panel.....	11
System Examples	12
Daisy Chain Connection	12
Ring Connection	12
Setup	13
About the AVS-ESMonitor Software	13
Initial Setup Using the Quick Setup Function	13
Individual Parameter Settings (Control Page)	16
Setup Error Messages	17
Head Amp Control	18
Control from a Digital Mixing Console	18
Control From the AVS-ESMonitor Application	18
Head Amplifier Parameters That Can be Monitored and Controlled	19
Troubleshooting	20
Troubleshooting	20
Messages	21
References	167
General Specification.....	167
Input/Output Characteristics	167
Electrical Characteristics	168
Dimensions	169
Compatible Host List.....	169

Included Accessories

- Owner's Manual
- AC Power Cable

Foreword

Thank you for choosing the Yamaha SB168-ES Stage Box. The SB168-ES is an EtherSound capable stage box with 16 analog inputs and 8 analog outputs. In order to take full advantage of the features and performance offered by the SB168-ES, be sure to read this owner's manual carefully before operation.

SB168-ES Features

■ Long-distance EtherSound Network Capability

Audio can be transferred over distances up to 100 meters* between devices via standard Ethernet cables using the EtherSound network protocol. The SB168-ES can be used as a general-purpose analog I/O box. Supported sampling rates are 44.1 kHz and 48 kHz (88.2 kHz and 96 kHz are not supported).

* Maximum practical distance may vary according to the cable used.

■ Remotely Controllable Internal Head Amplifiers

Internal head amplifier parameters can be remotely controlled from a compatible digital mixing console or from the AVS-ESMonitor application running on a computer.

■ Up to Four SB168-ES Units* Can Be Used for Expanded I/O

Up to four SB168-ES units can be used to provide a total of 64 inputs and 32 outputs.

* The maximum number of units that can be used may depend on the digital mixing console used.

Firmware Updates

Two types of firmware are required: firmware for the SB168-ES unit itself, provided by Yamaha, and EtherSound firmware provided by AuvitrAn.

The SB168-ES firmware can be updated from a computer connected to the rear-panel NETWORK connector. Information about the latest versions and firmware downloads are available at the Yamaha pro audio website SB168-ES product page:

<http://www.yamahaproaudio.com/products>

The EtherSound firmware can be updated from a computer connected to the EtherSound connector. Information about the latest versions and firmware downloads are available at the AuvitrAn website:

<http://www.auvitran.com/>

Connecting the AC Power Cable



- Before connecting the power cable, make sure that the power switches of all devices are turned OFF.

First connect the supplied power cable to the socket on the rear panel of the SB168-ES, then connect the AC plug to an appropriate AC power outlet (make sure the local supply voltage matches the rated AC voltage of the unit).

Powering ON or OFF



- To prevent loud noise bursts from the speakers when powering up the system, turn devices on in the following order: audio sources, SB168-ES, digital mixer, and finally power amplifiers. Reverse this order when turning the system off.

1. Press the [POWER] switch to turn the unit ON.
2. Press the [POWER] switch a second time to turn the unit OFF.



- The unit consumes a very small “standby” voltage even when the power switch is turned OFF. Be sure to unplug the AC power cable if the unit will not be used for an extended period of time.
- Rapidly turning the unit ON and OFF in succession can cause it to malfunction. After turning the unit OFF, wait for about 6 seconds before turning it ON again.

Precautions for Rack Mounting

This unit is rated for operation at ambient temperatures ranging from 0 to 40 degrees Celsius. When mounting the unit with other SB168-ES unit(s) or other device(s) in an EIA standard equipment rack, internal temperatures can exceed the specified upper limit, resulting in impaired performance or failure.

Always observe the following when rack mounting the unit:

- If three or more SB168-ES units are mounted without space in the same rack, set the fan speeds to HIGH.
- If multiple SB168-ES units are mounted in the same rack with their fan speeds set to LOW, leave a 1U rack space between every two units. Also either leave the open spaces uncovered or install appropriate ventilating panels to minimize the possibility of heat buildup.
- When mounting the unit in a rack with devices such as power amplifiers that generate a significant amount of heat, leave more than 1U of space between the SB168-ES and other device. Also either leave the open spaces uncovered or install appropriate ventilating panels to minimize the possibility of heat buildup.
- To ensure sufficient airflow, leave the rear of the rack open and position it at least 10 centimeters from walls or other surfaces. If the rear of the rack can't be left open, install a commercially available fan or similar ventilating option to secure sufficient airflow. If you've installed a fan kit, there may be cases in which closing the rear of the rack will produce a greater cooling effect. Refer to the rack and/or fan unit manual for details.

Recessed installation

If you want to recess the front panel surface of the device from the front edge of the rack, you can adjust the position of the rack mount brackets to recess the device by 50mm or 100mm.

NOTE • When you install the brackets, use the same screws that you just removed.

Resetting the Unit to Initial Factory Condition (Initialization)

This operation initializes the internal backup memory, resetting all head amplifier parameters to the original factory settings.

1. Turn the power OFF.
2. Move front-panel DIP switches 6 and 8 down to the ON position, then turn the power ON.

Initialization will take about one second.

When initialization is complete all [PEAK] indicators on the front panel will flash. At the same time the OUT [TX]/IN [RX] indicators will flash and the IN [TX] indicator will light.

3. Turn the power OFF, return DIP switches 6 and 8 to their original positions, then turn the power ON again.

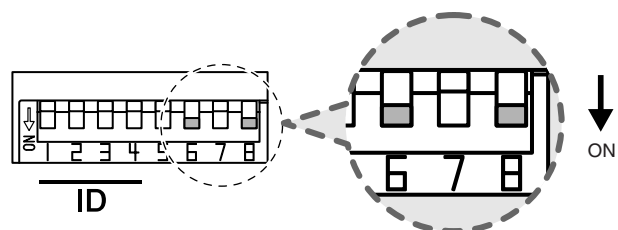

About EtherSound

EtherSound is ...

EtherSound is an audio networking protocol developed by Digigram in France. EtherSound allows up to 64 channels of uncompressed 24 bit/48 kHz audio to be bi-directionally transferred – 64 channels downstream plus 64 channels upstream – over a single CAT5e Ethernet cable. Up to 32 channels of 24 bit audio can be transferred when the sample rate is 96 kHz. Remote control signals for head amplifiers and other devices can be transferred simultaneously with the audio signals.

Signals can be transferred over distances of up to 100 meters* between devices. Even greater distances can be covered if media converters are used to convert the signals to optical fiber format.

* Dependent on cable quality. Refer to the website listed below for details.
<http://www.ethersound.com/>

Latency when transferring 48 kHz signals is 5 samples (104µsec), increasing by 1.4 µsec for each device added to the network (including network switches). EtherSound is the ideal choice for systems in which minimal latency is a priority.

The AVS-ESMonitor software application for Windows platforms that allows setup and monitoring of devices connected to an EtherSound network is available from the Auvitrans website at no charge.

<http://www.auvitran.com/>

Daisy Chain and Ring Networks

The most basic type of connection used for EtherSound networks is the serial “**Daisy Chain**.” Daisy chain networks allow 64 channels of audio to be independently transferred in both the downstream and upstream directions simultaneously. In this case the top device in the chain is the word clock master, known as the “**Primary Master**.”

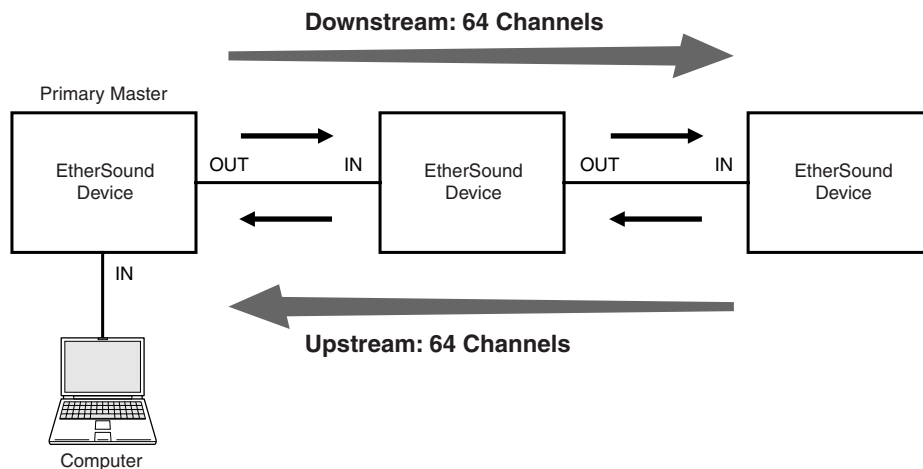

It is also possible to use **network switches** to distribute the signals to multiple devices. In this case devices connected directly to the network switch cannot send signals in the upstream direction.

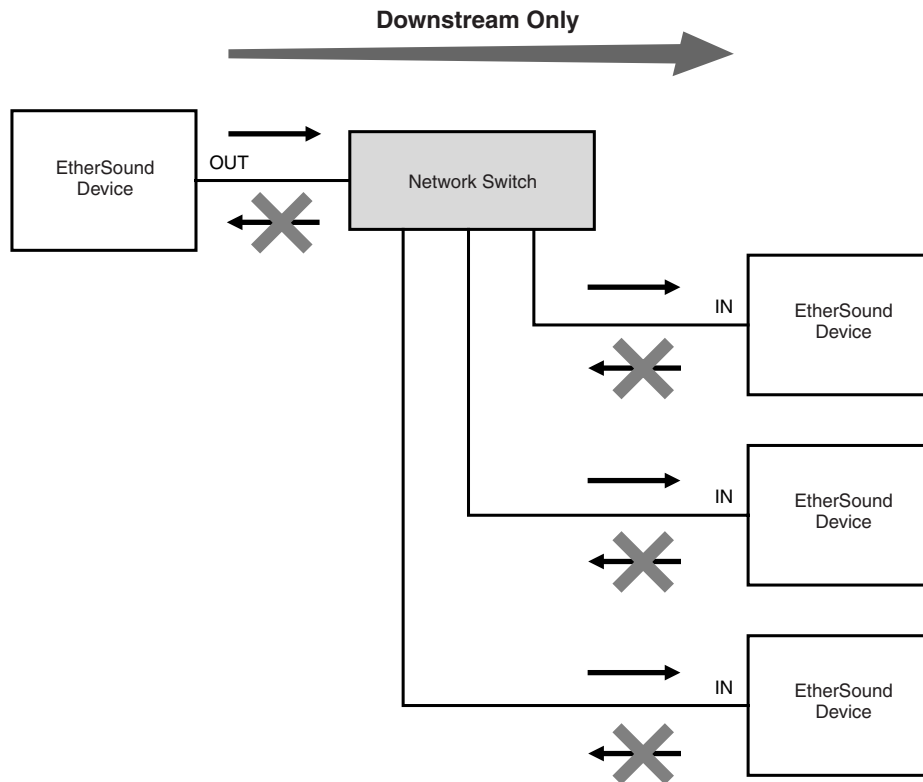

If a connection is broken in a daisy chain network, the signal flow is interrupted at that point and no signal will be transferred beyond that point. This weakness can be overcome by connecting the ends of a daisy chain network to form a ring that provides signal redundancy. In this type of “**Ring**” network a problem at one point in the network will not affect operation of the entire network. The compromise is that ring networks are limited to a total of 64 audio channels. It is also necessary to use EtherSound devices that support ring network connection (the SB168-ES does support ring networks). Network switches and similar devices cannot be used in a ring network.

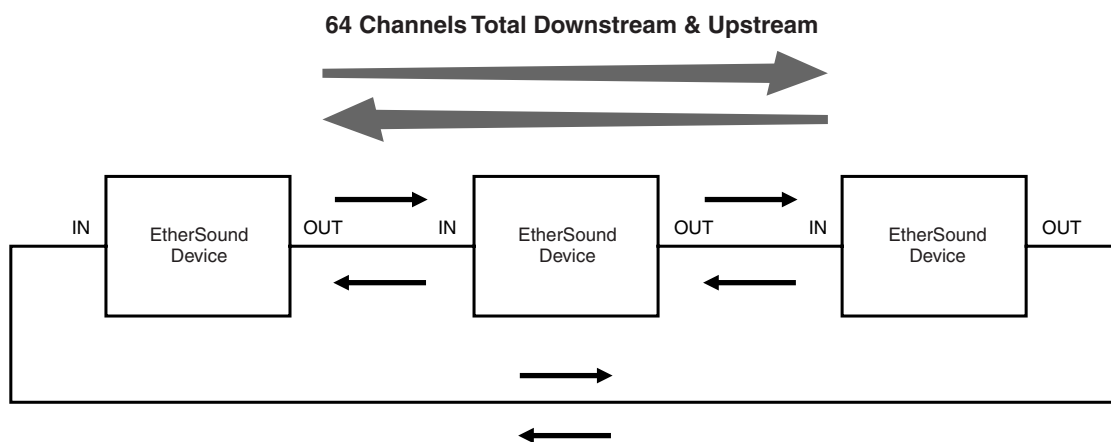

NOTE • For detailed information on EtherSound, refer to the EtherSound website: <http://www.ethersound.com/>, and the “EtherSound Setup Guide” at the Yamaha pro audio website SB168-ES product page: <http://www.yamahaproaudio.com/products/>

Controls and Functions

Front Panel

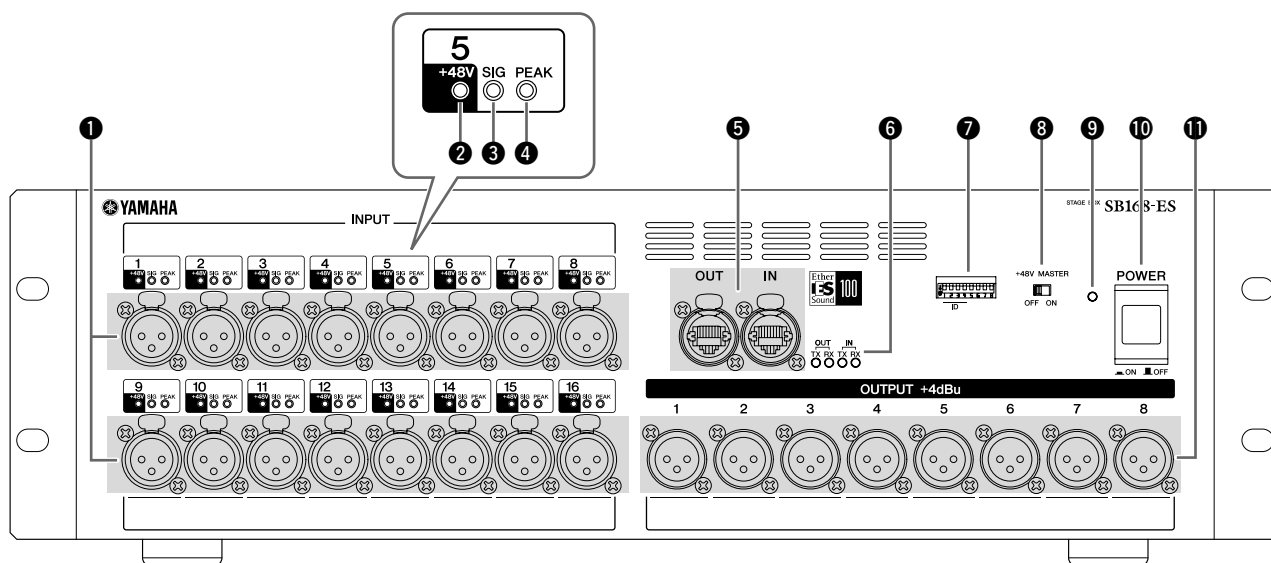

1 INPUT 1–16 Connectors

These are the XLR-3-31 type analog connectors for the 16 input channels. The input level range is from -62 dBu to +10 dBu. +48V phantom power can be supplied to devices that require it via the input connectors.

NOTE • The PAD will be switched on or off internally when the gain of the SB168-ES internal head amp is adjusted between -14 dB and -13 dB. Keep in mind that noise may be generated if there is a difference between the Hot and Cold impedance of the external device connected to the INPUT connector when using phantom power.

2 +48V Indicators

These indicators light when +48V phantom power is turned ON for the corresponding input channels. Phantom power supply switching can be carried out from a compatible digital mixing console or computer application. No phantom power will be supplied, however, if the [+48V MASTER] switch is OFF, even if phantom power to individual channels is turned ON (the +48V indicators will still light). The +48V indicators also function as error indicators: the indicators for all channels will flash if an error occurs.



- Make sure that phantom power is turned OFF unless it is needed.
- When turning phantom power ON, make sure that no equipment other than phantom-powered devices such as condenser microphones are connected to the corresponding INPUT connectors. Applying phantom power to a device that does not require phantom power can damage the device.
- Do not connect or disconnect a device to an INPUT while phantom power is applied. Doing so can damage the connected device and/or the unit itself.
- To prevent possible damage to speakers, make sure that power amplifiers and/or powered speakers are turned OFF when switching phantom power ON or OFF. We also recommend setting all digital mixing console output controls to minimum when turning phantom power ON or OFF. Sudden high level peaks caused by the switching operation can damage equipment as well as the hearing of those present.

3 SIG Indicators

These indicators light green when the signal applied to the corresponding channel reaches or exceeds -34 dBFS. The SIG indicators also function as error indicators: the indicators for all channels will flash if an error occurs.

4 PEAK Indicators

These indicators light red when the signal level of the corresponding channel reaches or exceeds -3 dBFS. The PEAK indicators also function as error indicators: the indicators for all channels will flash if an error occurs (and during initialization).

5 EtherSound [IN]/[OUT] Connectors

The SB168-ES can be connected to other EtherSound devices via these RJ-45 connectors using standard Ethernet cables (CAT5e or better recommended). [IN] and [OUT] connectors are provided to allow daisy chain or ring connection.

- NOTE**
- The use of Ethernet cables with Neutrik etherCON® CAT5 compatible RJ-45 plugs is recommended. Standard RJ-45 plugs can also be used.
 - Use STP (shielded twisted pair) cable to prevent electromagnetic interference. Make sure that the metal parts of the plugs are electrically connected to the STP cable shield by conductive tape or comparable means.
 - Refer to the following EtherSound website for the length of cable that can be used.
<http://www.ethersound.com/>

6 IN/OUT [TX]/[RX] Indicators

The appropriate indicator flashes when data is transmitted from (TX) or received at (RX) the EtherSound [IN]/[OUT] connectors.

These indicators will also light and/or flash to display errors, warnings, and information as described on page 21.

- NOTE**
- All four indicators will flash when the [Identify] button in the AVS-ESMonitor application (page 16) is clicked, and will continue to flash until the button is clicked a second time.

7 DIP Switches 1–8

Switches 1–4 of this 8-bit DIP switch are used to set the Setup ID as described on page 14.

8 [+48V MASTER] Switch

This is the master switch for the unit’s +48V phantom power supply. If the [+48V MASTER] switch is off no phantom power will be supplied to the unit’s input connectors even if the individual input phantom power settings are ON. However, the +48 indicators will light on channels for which phantom power is turned ON even if the [+48V MASTER] switch is OFF.

9 Power Indicator

Lights when AC power to the unit is ON.

10 [POWER] Switch

Turns power to the unit ON or OFF. Internal head amplifier settings such as gain, high-pass filter, etc., are retained in memory even when the power is OFF.

11 OUTPUT 1–8 Connectors

These eight XLR-3-32 type connectors deliver analog output from the unit’s corresponding output channels. Nominal output level is +4 dBu.

Rear Panel

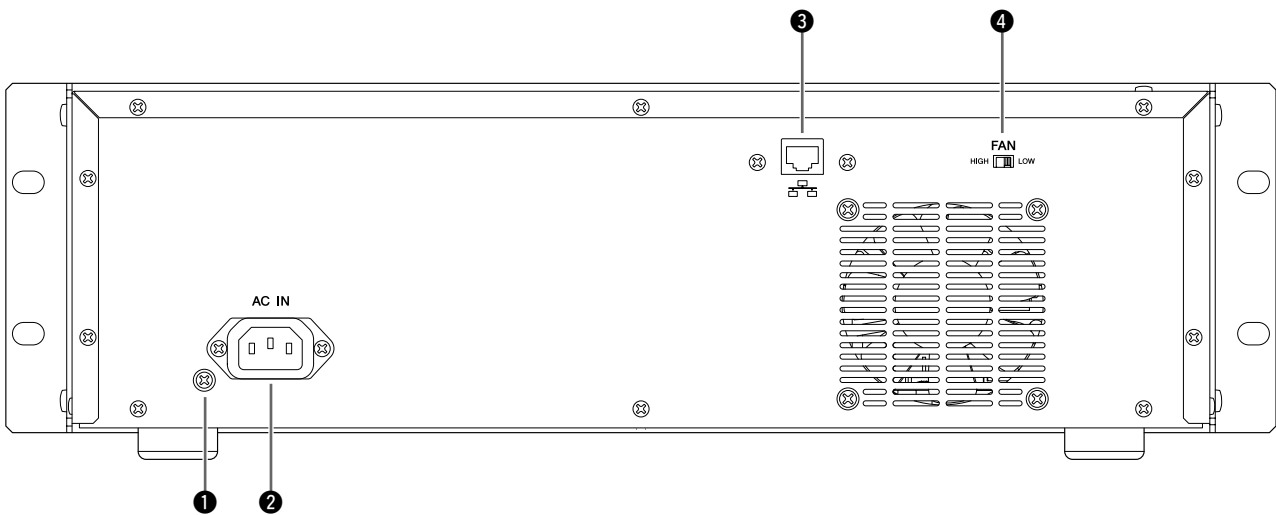

1 Earth Screw

For maximum safety, please earth the unit properly. The supplied AC power cable is a 3-wire type, so if the AC outlet used is properly earthed the SB168-ES will be earthed as well. If the AC outlet used is not earthed, however, please use the earth screw to earth the unit. In addition to maximizing safety, proper earth connection also effectively minimizes hum and interference.

2 [AC IN] Socket

Connect the supplied AC power cable here. First connect the AC power cable to the socket on the SB168-ES rear panel, then plug it into an appropriate AC power outlet.



- Use only the supplied AC power cable. The use of an inappropriate cable can result in equipment failure, overheating, or even fire.

3 NETWORK Connector

An Ethernet cable can be connected from a computer to this connector to allow updating the unit’s firmware.

- NOTE**
- Use STP (shielded twisted pair) cable to prevent electromagnetic interference (USA, Canada, and Europe).
 - Since the SB168-ES supports MDI/MDI-EX, either a straight or cross Ethernet cable can be used.

4 [FAN] Switch

Sets the internal cooling fan to operate at either HIGH or LOW speed. This switch is set to LOW when the unit is initially shipped from the factory. As long as the unit is operated within the specified ambient temperature range either the LOW or HIGH setting can be used. The HIGH setting is recommended if the ambient temperature is high, if the unit is in direct sunlight even if the ambient temperature is within the specified operating range, and in any situation in which fan noise is not a problem.

If two or more SB168-ES units are mounted in the same rack and the fan speed is set to LOW, leave a 1U rack space between every two units. Also either leave the open rack spaces uncovered or install appropriate ventilating panels to minimize the possibility of heat buildup. If three or more SB168-ES units are mounted without space in the same rack, set the fan speeds to HIGH.

System Examples

Daisy Chain Connection

In this example an MY16-ES64 EtherSound interface card is installed in a Yamaha M7CL or LS9 digital mixing console and connected to multiple SB168-ES units. In this type of system an MY16-EX I/O expansion card is also required for each additional SB168-ES unit connected in the daisy chain (i.e. for three SB168-ES units one MY16-ES64 card and two MY16-EX cards are required).

The EtherSound [OUT] connector on the MY16-ES64 card is connected to the [IN] connector of the first SB168-ES unit, and subsequent units are daisy chained as shown in the diagram. A computer can be connected to the EtherSound [IN] connector on the MY16-ES64 card functioning as Primary Master.

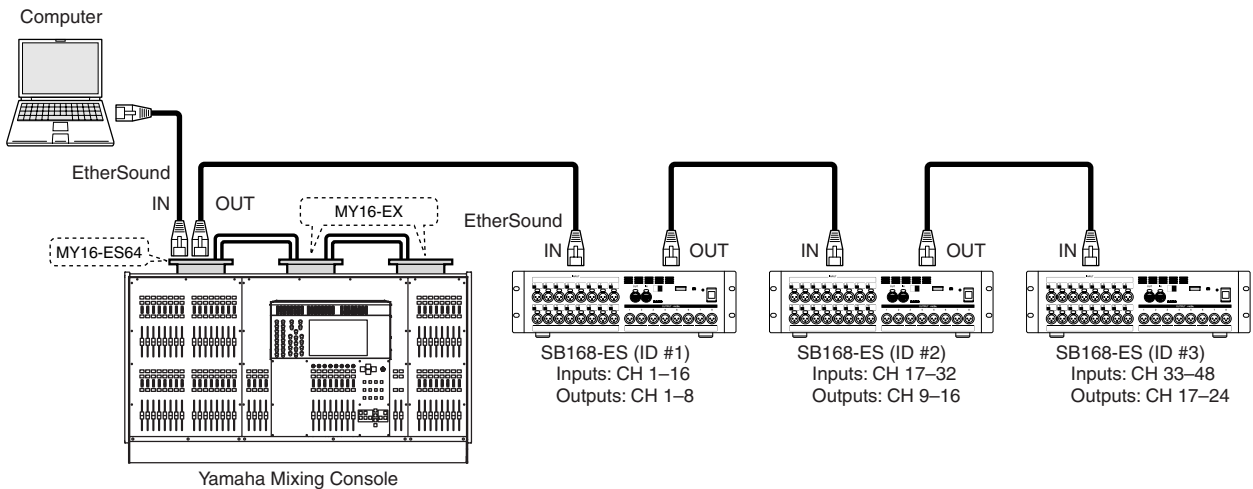

Daisy Chain Characteristics

- Four daisy chained SB168-ES units provide a total of 64 input channels and 32 output channels.
- The computer can remain connected at all times, making it possible to use the AVS-ESMonitor application to control the SB168-ES head amplifiers and continuously monitor the EtherSound network.
- If a connection is broken in a daisy chain network, the signal flow is interrupted at that point and no signal will be transferred beyond that point.

Ring Connection

As in the daisy chain example above, an MY16-ES64 EtherSound interface card is used to connect the digital mixing console to the SB168-ES units. The EtherSound [OUT] connector is connected to the EtherSound [IN] connector of the subsequent unit, and the EtherSound [OUT] connector of the final SB168-ES unit is connected back to the EtherSound [IN] connector of the MY16-ES64 card.

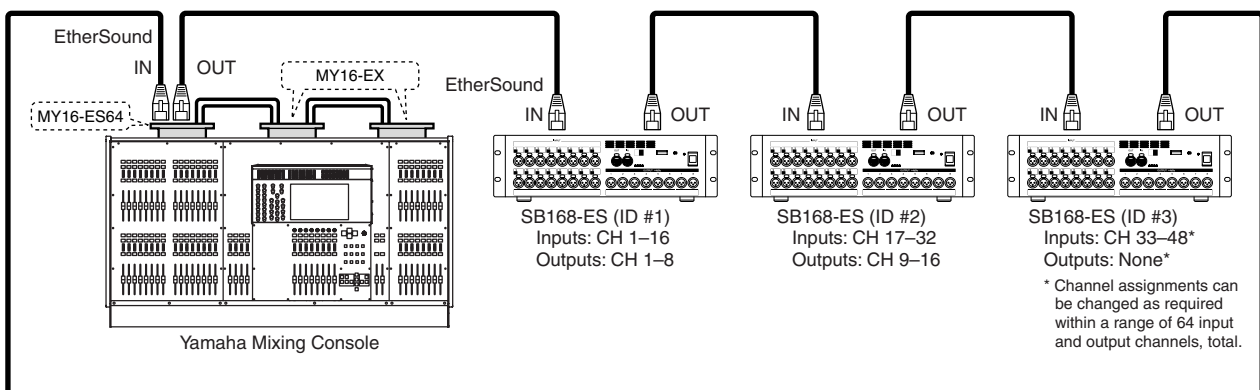

Ring Connection Characteristics

- The EtherSound specifications limit the total number of input and output channels to 64 in this type of network.
- The AVS-ESMonitor application cannot be used during system operation. An EtherSound device with a third port is required to connect a computer running AVS-ESMonitor into the ring.
- A problem at one point in the network will not affect operation of the entire network.

NOTE • In ring connections it is particularly important to ensure that all EtherSound devices are running the latest firmware (page 6).

Setup

About the AVS-ESMonitor Software

AVS-ESMonitor is a software application from the Auvitran company that allows monitoring and control of EtherSound networks. It can be used to make input/output assignments and set the EtherSound parameters as required. Please download the AVS-ESMonitor application from the website listed below. AVS-ESMonitor versions 3.4.6 and later support the SB168-ES.

<http://www.auvitran.com/>

Initial SB168-ES setup can be performed quickly and easily using the AVS-ESMonitor Quick Setup function. The Quick Setup function provides the following capabilities:

- Sets up necessary EtherSound settings for the SB168-ES and MY16-ES64. EtherSound devices other than the SB168-ES and MY16-ES64 are not affected, but patches to those other EtherSound devices will be cleared.
- Support for up to four SB168-ES units connected to an MY16-ES64.
- The Quick Setup function cannot be used if two or more MY16-ES64 cards are connected to the network. To connect multiple SB168-ES units, add one MY16-EX card for each additional SB168-ES unit added to the network (an MY16-EX card is not required for the first or only SB168-ES unit in a network).
- After the Quick Setup function is executed, as long as the network connections are not changed there is no need to perform the Quick Setup procedure again. However, if the number and/or order of the SB168-ES units are changed, or the connected devices (SB168-ES, MY16-ES64) are replaced, it will be necessary to perform the Quick Setup operation again.

The Quick Setup function cannot be used when EtherSound cards from other manufacturers are used. In such a case the necessary initial parameters must be set up manually: refer to “Individual Parameter Settings (Control Page)” on page 16 for details. When connecting with the M7CL-48ES, the Auto Configure function can apply the patch settings automatically without the AVS-ESMonitor application. The latest firmware for the SB168-ES will be required in this case.

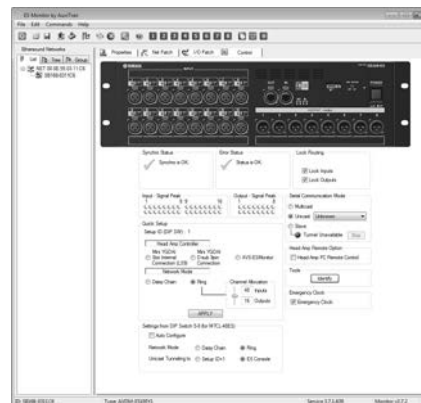

Initial Setup Using the Quick Setup Function

Preparation

1. Determine the source for head amplifier parameter control:

A. MY16-ES64 Slot Internal Connection (LS9)

Use this option is for digital mixing consoles such as the LS9 that don't have a 9-pin D-sub “HA REMOTE” connector.

B. MY16-ES64 D-sub 9-pin Connection

Use this option for digital mixing consoles such as the M7CL or digital mixing engines such as the DME64N or DME24N that have a 9-pin D-sub “HA REMOTE connector.

C. AVS-ESMonitor

- NOTE** • Refer to page 169 to determine whether your digital mixing console can be used to control the SB168-ES.

2. Turn the power to all devices OFF.

3. Set the switches on the MY16-ES64 and MY16-EX circuit boards.

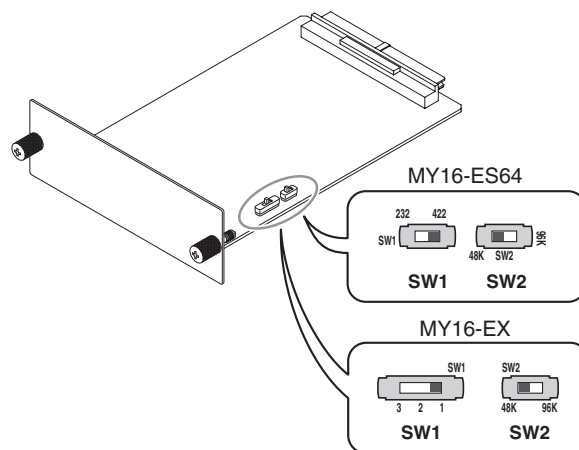

- If you selected option B in step 1, set the SW1 switch on the MY16-ES64 to [422].
- Set the SW2 switch on the MY16-ES64 to [48K].
- When one or more MY16-EX cards are to be used, SW1 on the MY16-EX sets the ID number. ID numbers should be assigned in sequence, corresponding to the order the cards are to be connected to the MY16-ES64.
- Set the SW2 switches on all MY16-EX cards to [48K].

4. Install the MY16-ES64 and MY16-EX cards in the digital mixing console's slots, then connect the required Ethernet cables.

- NOTE**
- For details on installing and connecting the cards, refer to instructions provided with each product.
 - When installing an MY16-ES64 card in an LS9-32 console, install the card in SLOT 1.

5. Set the ID of each SB168-ES unit via the DIP switches (1–4) in the order they are connected, taking care not to duplicate any of the ID settings.

Example: Setup ID = 1

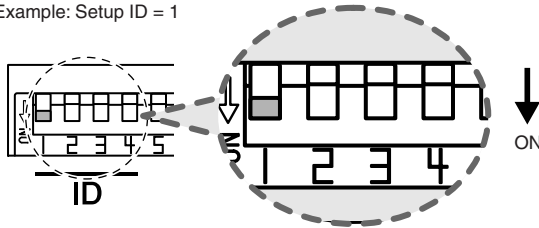

The DIP switch corresponding to the desired ID number should be moved to its “down” (ON) position. All other switches should remain in their “up” positions.

6. Make the required daisy chain connections between the MY16-ES64 card and the SB168-ES units.

- NOTE**
- When setting up a ring type network, initial settings should be made with the system connected as a daisy chain. Close the ring connection after the initial settings have been made.

7. Connect the computer to the MY16-ES64 Ether-Sound [IN] connector.

8. If you selected option B in step 1, connect the digital mixing console's [REMOTE] connector to the MY16-ES64 card [HA REMOTE] connector via a 9-pin D-sub cross cable.

9. Turn the power to all devices ON.

10. Select the word clock master on the digital mixing console. For a daisy chain network select either [INT48K] or [INT44.1K], and for a ring network select the [1/2] channel of the slot in which the MY16-ES64 card is installed.

11. If you selected option A in step 1, and are using an LS9-32 console, select [SLOT 1] via the console's EXTERNAL HA display COMM PORT parameter.

Setup Procedure

1. Launch the AVS-ESMonitor application in online mode.

- NOTE**
- If the AVSMonitor application has been launched in offline mode, it can be switched to online mode by clicking [Switch offline mode] in the [Command] menu.

2. Click [Reset networks] in the [Command] menu.
3. In the tree views select one of the SB168-ES units on the network.
4. Open the Control tab.

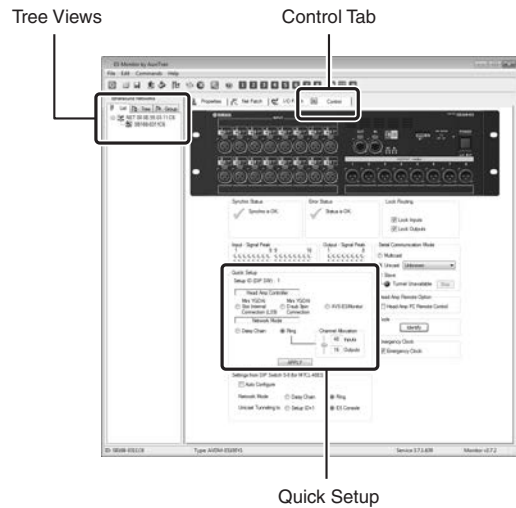

5. Select the control source determined in the previous section via the Quick Setup Head Amp Controller field.



6. Select the EtherSound network connection type via the Network Mode field.

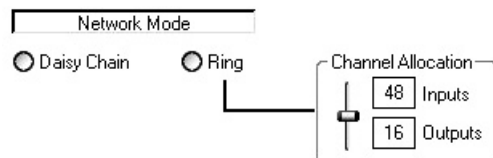

- 7. If a ring network is to be used, use the Channel Allocation slider to select an input/output channel combination. The possible combinations are as follows:**

Inputs (No. of Input Channels)	32	40	48	56	64
Outputs (No. of Output Channels)	32	24	16	8	0

In ring networks the total number of input and output channels is limited to 64. If the network includes only one or two SB168-ES units you can select from 32 Inputs/32 Outputs to 48 Inputs/16 Outputs without exceeding the limitation. If three or four SB168-ES units are connected you will need to decide whether to give priority to inputs or outputs. For example, you could select 64 Inputs/0 Outputs if you want to use all available input channels, or 32 Inputs/32 Outputs if you want to use all available output channels.

- 8. Click the [APPLY] button, then click the [OK] button in response to the confirmation dialog that appears.**

- 9. If the Quick Setup operation has completed successfully a “Quick Setup is done successfully” message will appear.**

The Quick Setup fields will return to their initial state when the Quick Setup operation has finished.

- 10. If you are setting up a ring network, disconnect the computer from the MY16-ES64 card EtherSound [IN] connector, and connect the EtherSound [OUT] connector on the last SB168-ES unit in the chain back to the EtherSound [IN] connector on the MY16-ES64 card to complete the ring.**

When four SB168-ES units are daisy chained, their input channels are assigned to MY16-ES64 input channels 1–64 in order from the first SB168-ES unit in the chain (Setup ID #1) as follows: 1–16, 17–32, 33–48, 49–64. The MY16-ES64 output channels are assigned to the SB168-ES outputs in the same way: 1–8, 9–16, 17–24, 25–32.

In a ring network the input and output channels are assigned in sequence from the first to last SB168-ES unit within the maximum 64-channel limitation, according to the number of SB168-ES units used and the Channel Allocation setting.

- NOTE**
- As long as the network connections are not changed there is no need to perform the Quick Setup procedure again. However, if the number and/or order of the SB168-ES units are changed, or the connected devices (SB168-ES, MY16-ES64) are replaced, it will be necessary to perform the Quick Setup operation again.
 - If other types of EtherSound devices are connected, or the channel assignments are to be changed, it will be necessary to set the appropriate parameters individually via the AVS-ESMonitor application. Refer to “Individual Parameter Settings (Control Page)” on page 16 and/or the AVS-ESMonitor operation manual for details.
 - Set up the digital mixing console input patching in sequential 8-channel groups for the slot inputs (CH1–8, CH9–16, etc.). This makes it easy to select input channels on the external SB168-ES units for remote head amplifier control.
 - When the Quick Setup function is executed the settings are saved to non-volatile memory in EtherSound devices on the network, overwriting any previous data. Since the previous data is overwritten and thereby erased, you might want to save important settings before executing the Quick Setup function via the [Save As] command in the [File] menu.

Individual Parameter Settings (Control Page)

When connecting to devices that are not supported by the Quick Setup function, or when you need to make changes to specific EtherSound settings, the parameters in the AVS-ESMonitor Control page provide access to head amplifier control settings while those in the Net Patch and I/O Patch pages provide access to the input and output channel settings. Refer to the AVS-ESMonitor manual for details on the Net Patch and I/O Patch pages.

The screenshot displays the AVS-ESMonitor Control page with the following sections:

- Synchro Status:** Shows a checkmark and the text "Synchro is OK."
- Error Status:** Shows a checkmark and the text "Status is OK."
- Lock Routing:** Includes checkboxes for "Lock Inputs" and "Lock Outputs", both of which are checked.
- Input - Signal Peak:** A row of 16 indicators, with the first 8 labeled "1" and the last 8 labeled "16".
- Output - Signal Peak:** A row of 8 indicators, with the first 4 labeled "1" and the last 4 labeled "8".
- Serial Communication Mode:** Includes radio buttons for "Multicast", "Unicast" (selected), and "Slave". A dropdown menu shows "Unknown". A "Tunnel Unavailable" button is also present.
- Head-Amp Remote Option:** Includes a checkbox for "Head-Amp PC Remote Control".
- Tools:** Includes an "Identify" button.
- Emergency Clock:** Includes a checked checkbox for "Emergency Clock".
- Quick Setup:** Shows "Setup ID (DIP SW) : 1". Under "Head Amp Controller", there are radio buttons for "Mini YGDAI Slot Internal", "Mini YGDAI D-sub 9pin Connection (LS9)", and "AVS-ESMonitor". Under "Network Mode", there are radio buttons for "Daisy Chain" and "Ring" (selected). A "Channel Allocation" slider is set between "48 Inputs" and "16 Outputs". An "APPLY" button is at the bottom.
- Settings from DIP Switch 5-8 (for M7CL-48ES):** Includes a checkbox for "Auto Configure". Under "Network Mode", there are radio buttons for "Daisy Chain" and "Ring" (selected). Under "Unicast Tunneling to", there are radio buttons for "Setup ID+1" and "ES Console".

Synchro Status

Displays the current EtherSound network synchronization status.

Error Status

Displays SB168-ES error messages. The indicators on the SB168-ES indicate the type of error by the way they flash or light, while specific error messages are displayed here.

Lock Routing

This parameter makes it possible to temporarily lock editing of the patches in the I/O Patch page, preventing possible operation errors. "Lock Inputs" locks the IN > ES patches, while "Lock Outputs" locks the OUT < ES patches.

Input Signal Peak/Output Signal Peak

Signal and peak indicators for the input and output channels. The upper row is the PEAK indicators, which light red, and the lower row is the SIGNAL indicators, which light green.

Serial Communication Mode

Select [Unicast] when controlling the head amplifiers from a compatible digital mixing console, and select the MY16-ES64 card as the communication target. It is also necessary to set the MY16-ES64 Serial Communication Mode.

Select [Slave] when controlling the head amplifiers directly from the AVS-ESMonitor application.

The [Multicast] setting is provided for future expansion, and is not currently available.

Head Amp Remote Option

When controlling the head amplifiers from the AVS-ESMonitor application, a Head Amp page that provides access to the head amplifier control parameters will be added to the

interface if the [Head Amp PC Remote Control] checkbox is checked after selecting [Slave] in the Serial Communication Mode section.

Tools

When the [Identify] button is clicked the SB168-ES IN/OUT [TX]/[RX] indicators will flash, and will continue to flash until the button is clicked a second time.

Emergency Clock

If the EtherSound network is used in a ring configuration, turn this checkbox ON to prevent audio interruptions when a connection in the ring is broken. If Emergency Clock is OFF, audio will be interrupted.

For daisy chain configurations, if the SB168-ES is the primary master, turn this checkbox OFF to select the SB168-ES internal word clock or ON to use the EtherSound module word clock. If the SB168-ES is not primary master, the Emergency Clock checkbox has no effect.

NOTE • See page 13 for information on the Quick Setup function.

Settings from DIP Switch 5–8 (for M7CL-48ES)

These are the settings for use when connecting with the M7CL-48ES using the Auto Configure function. The settings of "Network Mode" and "Unicast Tunneling to" are displayed by scanning the status of the DIP switches 5–8 when the power is turned ON.

When you want to temporarily change the EtherSound settings (including "Network Mode" and "Unicast Tunneling to") in the AVS-ESMonitor application, turn the Auto Configure checkbox OFF.

Setup Error Messages

If any of the error messages listed below appears while executing the Quick Setup function, resolve the problem as required and then execute Quick Setup again.

When changing a Setup ID setting be sure to turn the device's power OFF, change the DIP switch settings as required, and then turn the device ON again.

Error Message	Details and Solution
Setup ID is discontinuous. Setup ID #n not found.	The Setup ID numbers are not sequential—ID “#n” is missing. Referring to the “Preparation” instructions on page 13, use the DIP switches to set the Setup ID numbers in sequence beginning from #1.
There are two or more with same Setup ID #n. (flashing)	Two or more SB168-ES units have the same Setup ID number. When duplicate Setup ID numbers are detected the SB168-ES IN/OUT [TX]/[RX] indicators will flash. Referring to the “Preparation” instructions on page 13, check the DIP switch settings and make sure that each unit has a unique Setup ID.
There are two or more MY16-ES64(s). (flashing)	Two or more MY16-ES64 cards have been detected on the EtherSound network. The use of two or more MY16-ES64 cards is not supported by the Quick Setup function. The IN/OUT [TX]/[RX] indicators of the MY16-ES64 cards will flash. Redo the connections so that only one MY16-ES64 is connected to the network.
MY16-ES64 is not found in ES network.	No MY16-ES64 card can be located on the EtherSound network. EtherSound interface cards other than the MY16-ES64 are not supported by the Quick Setup function.
MY16-ES64 is not Primary Master. (flashing)	The MY16-ES64 is not functioning as Primary Master in a daisy chain network. This type of configuration is not supported by the Quick Setup function. The IN/OUT [TX]/[RX] indicators of the MY16-ES64 card will flash while this error message is displayed. Redo the connections so that the MY16-ES64 functions as Primary Master.
Setup ID of all SB168-ES is not assigned.	The Setup ID has not been set for any of the SB168-ES units on the EtherSound network. The Setup ID for at least one unit must be set. The IN/OUT [TX]/[RX] indicators of the SB168-ES units will flash while this error message is displayed. Referring to the “Preparation” instructions on page 13, set the Setup ID numbers of the connected SB168-ES units. No error will occur if the Setup ID is not set for one of the SB168-ES units in a multi-unit system, but the patch settings for that SB168-ES unit will be cleared.
MY16-ES64 is not 48kHz. 96kHz is selected.	The sampling frequency of the MY16-ES64 card connected to the EtherSound network is set to 96 kHz (SW2). The SB168-ES does not support 88.2 kHz or 96 kHz sampling frequencies. The IN/OUT [TX]/[RX] indicators of the MY16-ES64 card will flash while this error message is displayed. Referring to the “Preparation” instructions on page 13, set the SW2 switch on the MY16-ES64 card to [48K].
The power supply was turned off or the cable was disconnected.	The power to one of the devices connected to the EtherSound network was turned off, or a cable was disconnected during Quick Setup execution. Check the power cables and power switch settings of all devices and execute the Quick Setup function again.
Audio routing locked on device. (flashing)	The Quick Setup function cannot be executed if the Lock Routing parameter in the Control page is ON. The IN/OUT [TX]/[RX] indicators of the MY16-ES64 card and SB168-ES units will flash while this error message is displayed. In order to execute the Quick Setup function all Lock Routing parameters must be turned OFF.

Head Amp Control

The SB168-ES head amplifiers can be remotely controlled from host devices such as a compatible digital mixing console or digital mixing engine (see page 169), or from the AVS-ESMonitor application.

Control from a Digital Mixing Console

The SB168-ES head amplifiers can be controlled from a compatible digital mixing console. In order to control the head amplifiers from a digital mixing console, select control via an MY16-ES64 in the Quick Setup Head Amp Controller field.

Each SB168-ES unit will be represented by two AD8HR units (AD8HR #1, AD8HR #2, etc.) on the digital mixing console display, and the SB168-ES parameters can be controlled in the same way as AD8HR parameters. Furthermore, scene recall can be used to recall all head amplifier settings at once.

Refer to the digital mixing console owner's manual for details on head amplifier control.

Model	Section Title in Owner's Manual
M7CL, LS9	Using an external head amp
DM1000	Using the AD8HR/AD824
DM2000	Controlling AD8HR/AD824 A/D Converters
PM5D/PM5D-RH	Reference section: SYS/W.CLOCK function—HA (Head Amp) screen
DME64N/24N	Controlling external head amplifiers from the DME64N/24N, Head Amplifier Setup (HA) Page

NOTE • SB168-ES error messages are not shown on the digital mixing console display, and EtherSound parameters cannot be set from the digital mixing console. Use the AVS-ESMonitor software application for these functions.

Control From the AVS-ESMonitor Application

The AVS-ESMonitor application can be used both to set EtherSound parameters and control the SB168-ES head amplifiers. To control the head amplifiers from the AVS-ESMonitor application, either select AVS-ESMonitor in the Quick Setup Head Amp Controller field or perform the setup procedure described below and a Head Amp page will be added to the AVS-ESMonitor interface.

1. Select the SB168-ES to be controlled in the tree views.

NOTE • If multiple SB168-ES units are to be controlled, repeat the procedure described below for each one.

2. Select [Slave] in the Serial Communication mode section.

Check each Control page and make sure that no other EtherSound device is assigned to transmit to this SB168-ES unit. If the SB168-ES is selected, temporarily switch to the [Slave] setting.

3. Check the [Head Amp PC Remote Control] Checkbox.

A Head Amp tab will appear.

The image shows two sections of the AVS-ESMonitor interface. The top section, titled "Serial Communication Mode", contains three radio button options: "Multicast", "Unicast" (with a dropdown menu), and "Slave" (which is selected). Below these is a "Tunnel Unavailable" indicator and a "Stop" button. The bottom section, titled "Head-Amp Remote Option", contains a single checked checkbox labeled "Head-Amp PC Remote Control".

4. Click the Head Amp Tab.

It can take a few seconds for the channel name in the Ch Selection field to appear.

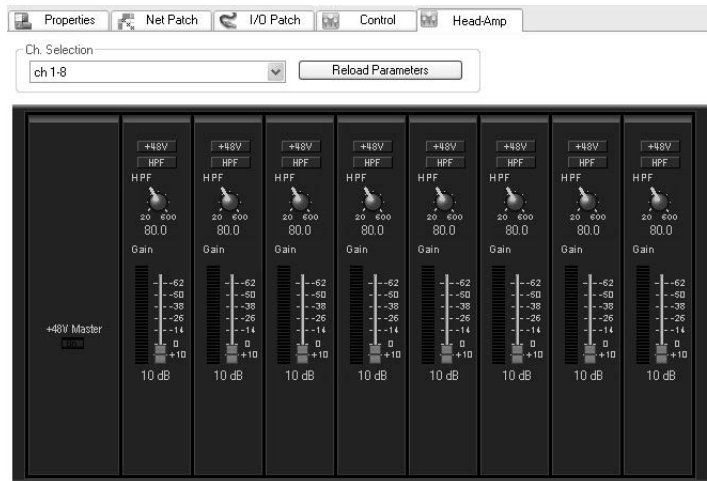

The head amplifier parameters can be controlled from this display. The current parameter settings will be shown on the display when “ch 1-8” or “ch 9-16” is selected from the Ch Selection filed.

- NOTE**
- If you later decide to switch back to controlling the head amplifiers from a digital mixer, we recommend executing the Quick Setup function again, although the same result can be achieved by un-checking the [Head Amp PC Remote Control] checkbox and setting the Serial Communication Mode to [Unicast] (via an MY16-ES64).
 - The AVS-ESMonitor application cannot be used while a ring network is in operation. In order to use the AVS-ESMonitor application to control the head amplifiers it is necessary to either switch to a daisy chain configuration or add an EtherSound device with a third-port to the system.
 - The on-screen head amplifier controls can be operated both by click-and-drag and via the mouse scroll wheel.

Head Amplifier Parameters That Can be Monitored and Controlled

Parameter	Description
+48V	Turns +48V phantom power ON or OFF for each channel.
HA GAIN	Adjusts gain from -62 dB to +10 dB in 1-dB increments.
HPF	Turns the high-pass filter ON or OFF.
HPF FREQ	Adjusts the cutoff frequency of the high-pass filter (12 dB/Oct.) from 20 Hz to 600 Hz in 60 steps.
METER	Displays a level meter for each input channel.
Device ID	Displays the automatically assigned device ID numbers 1–8 (corresponding to AD8HR device ID numbers). Two ID numbers are assigned to each SB168-ES unit.
+48V Master SW	Displays the master ON/OFF status of the +48V phantom power supply.

- NOTE**
- Sound output may be briefly interrupted when adjusting gain, but this is normal. Since the gain is being internally adjusted in 6-dB steps, output is briefly muted to prevent noise.
 - The following parameters are not supported and cannot be edited even if shown on the display: Device Mode/Name, Word Clock Source, Gain trim, Panel Lock, LED Brightness

Troubleshooting

Troubleshooting

Symptom	Possible Solution
The power won't turn on. The power indicator doesn't light.	<ul style="list-style-type: none"> • Is the power cable connected properly? (page 6) • Is the [POWER] switch properly engaged? (page 7) • If you've checked all possible causes and the power still won't come on, refer the problem to your Yamaha dealer.
The unit is not receiving an input signal.	<ul style="list-style-type: none"> • Are the input cables properly connected? • Are the source devices delivering an appropriate signal? Check the SIG indicators on the appropriate channels. • Have you executed the Quick Setup function? Did you change any patch settings via the AVS-ESMonitor application after executing the Quick Setup function? • Are the AVS-ESMonitor patch settings appropriate (Net Patch or I/O Patch page)? • Is the head amplifier gain set to an appropriate level?
The input level is too low.	<ul style="list-style-type: none"> • If a condenser microphone is being used, is the [+48V MASTER] switch ON? • If a condenser microphone is being used, is phantom power for the corresponding channel(s) turned ON? • Is the head amplifier gain set to an appropriate level?
No output.	<ul style="list-style-type: none"> • Are the output cables properly connected? • Have you executed the Quick Setup function? Did you change any patch settings via the AVS-ESMonitor application after executing the Quick Setup function? • Are the AVS-ESMonitor patch settings appropriate (Net Patch or I/O Patch page)? • Is output muted at the digital mixing console?
An error message is displayed during Quick Setup.	<ul style="list-style-type: none"> • Refer to page 17 for information on error messages that might be displayed during execution of the AVS-ESMonitor Quick Setup function.
Head amplifier remote control isn't working.	<ul style="list-style-type: none"> • Did you make the appropriate Head Amp Controller setting when executing the Quick Setup function? Did you change the Serial Communication Mode setting after executing the Quick Setup function? • Is the AVS-ESMonitor Serial Communication Mode set properly? (page 16) • If you will be controlling the head amplifiers via the 9-pin D-sub REMOTE connector on a digital mixing console, is the mixing console's REMOTE connector properly connected to the HA REMOTE connector on the MY16-ES64 card (Primary Master)? (page 14) • If you will be controlling the head amplifiers via a mixing console expansion slot, is the EXTERNAL HA display COMM PORT parameter set appropriately? (page 14) • Set up the digital mixing console input patching in sequential 8-channel groups for the slot inputs (CH1–8, CH9–16, etc.). This makes it easy to select input channels on the external SB168-ES units for remote head amplifier control.
Can't control the SB168-ES by the M7CL-48ES.	<ul style="list-style-type: none"> • Is the Stage Box Setup function of the M7CL-48ES set properly? • Did you correctly set the DIP switches before turning on the power to the devices? • Has the firmware been updated to an appropriate version?
<ul style="list-style-type: none"> • Can't execute Quick Setup in the AVS-ESMonitor • Can't change Serial Communication Mode in the AVS-ESMonitor 	<ul style="list-style-type: none"> • Is the AUTO CONFIGURE button for the Stage Box Setup function turned off? • Are DIP switches 5–8 for the SB168-ES set to OFF (upper position)?

Messages

Errors, warnings, and certain other types of information are displayed via the SB168-ES panel indicators. Messages are also displayed in the AVS-ESMonitor Error Status field.

Error Messages

When an error occurs the indicators for channels 1 through 16 will flash until the error is resolved, and the IN/OUT [TX]/[RX] will light and/or flash as shown in the chart below. If repair is required contact your Yamaha dealer.

Indicators	AVS-ESMonitor Error Status	Details	Solution
<p>OUT IN TX RX TX RX ● ○ ○ ● on flash</p>	No Battery!	The backup battery is almost completely depleted, and there is a possibility that the stored settings will be lost.	If you turn off the power at this point there is a possibility that all current settings will be lost and the unit will be initialized. Stop using the unit immediately and contact your Yamaha dealer.
<p>OUT IN TX RX TX RX ○ ● ○ ○ flash on flash</p>	Critical Battery!	The backup battery is running low, and there is a possibility that the stored settings will be lost.	If you continue to use the unit there is a possibility that all current settings will be lost and the unit will be initialized. Stop using the unit as quickly as possible and contact your Yamaha dealer.
<p>OUT IN TX RX TX RX ○ ○ ○ ○ flash flash flash</p>	Low Battery!	The backup battery is beginning to run low.	
<p>OUT IN TX RX TX RX ● ○ ○ ○ on flash flash</p>	Memory Error! All Memories were Initialized.	The internal backup memory was corrupted and all data has been initialized.	If the error reoccurs after restarting the unit there is a possibility that the backup battery has been depleted. Contact your Yamaha dealer.
<p>OUT IN TX RX TX RX ○ ○ ● ○ on flash</p>	Network Hardware Error!	A malfunction has been detected in one of the devices connected to the network.	Contact your Yamaha dealer.
<p>OUT IN TX RX TX RX ○ ○ ● ○ flash on flash</p>	Illegal MAC Address! Cannot Use Network.	The MAC address setting has been corrupted and no communication can occur via the NETWORK terminal.	Contact your Yamaha dealer.
<p>OUT IN TX RX TX RX ○ ● ● ○ flash on on flash</p>	EtherSound is Not Initialized!	EtherSound is not initialized.	EtherSound initialization has failed. Contact your Yamaha dealer.
<p>OUT IN TX RX TX RX ● ○ ● ○ on on flash</p>	Different EtherSound Module Type!	An unrecognized EtherSound module has been detected.	The device requires repair. Contact your Yamaha dealer.
<p>OUT IN TX RX TX RX ● ○ ● ○ on flash on flash</p>	EtherSound Hardware Error!	An internal EtherSound error has occurred.	An internal malfunction may have occurred. Contact your Yamaha dealer.

Warning Messages

The indicators will light and/or flash as shown until the cause is resolved.

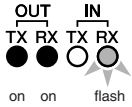
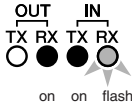
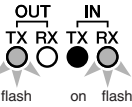
Indicators	AVS-ESMonitor Error Status	Details	Solution
 <p>on on flash</p>	Fan has Malfunctioned!	The cooling fan has stopped operating.	Check that nothing is caught in the fan. If the problem cannot be easily resolved, contact your Yamaha dealer.
 <p>on on flash</p>	Duplicate IP Address!	A device with an IP address that is the same as the SB168-ES fixed IP address is connected to the NETWORK connector.	Change the IP address of the device connected to the NETWORK connector to an IP address other than 192.168.0.2.
 <p>flash on flash</p>	Illegal DIP Switch Setting!	The device is operating with the DIP switches set to initialization or some other special mode.	To resume normal operation turn the power OFF, set DIP switches 5–8 to their “up” positions, then turn the power ON again.

Information

The indicators will flash and/or light for 10 seconds.

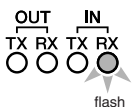
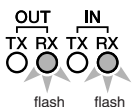
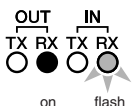
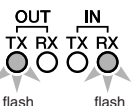
Indicators	AVS-ESMonitor Error Status	Details	Solution
 <p>flash</p>	HA Remote Communication Error! (Rx Buffer Full)	Too much data has been received at the HA Remote input port.	If any of these errors occur frequently, a device malfunction may be the cause. Contact your Yamaha dealer.
 <p>flash flash</p>	HA Remote Communication Error! (Overrun)	An inappropriate signal has been received at the HA Remote input port.	
 <p>on flash</p>	HA Remote Communication Error! (Framing)	An inappropriate signal has been received at the HA Remote input port.	
 <p>flash flash</p>	HA Remote Communication Error! (Tx Buffer Full)	Too much data has been transmitted via the HA Remote output port.	

References

General Specification

Power Requirements	US/Canada: 120V 65W, 60Hz Korea: 220V 65W, 60Hz China: 110V–240V 65W, 50/60Hz Japan: 100V 65W, 50/60Hz Other: 110V–240V 65W, 50/60Hz
Dimensions	480 x 350 x 132 mm (W x D x H)
Net Weight	8 kg
Temperature Range	Operation free-air : ± 0 °C to +40 °C Storage : -20 °C to +60 °C
AC Cable Length	250 cm
Accessories	Owner's Manual, AC Cable

Input/Output Characteristics

● Analog Input Characteristics

Input Terminals	GAIN	Actual Load Impedance	For Use With Nominal	Input Level		Connector
				Nominal	Max. before clip	
INPUT 1–16	-62 dB	3 k Ω	50–600 Ω Mics & 600 Ω Lines	-62 dBu (0.616 mV)	-42 dBu (6.16 mV)	XLR-3-31 type (Balanced)* ¹
	+10 dB			+10 dBu (2.45 V)	+30 dBu (24.5 V)	

*1. XLR-3-31 type connectors are balanced. (1=GND, 2=HOT, 3=COLD)

* In these specifications, when dBu represents a specific voltage, 0 dBu is referenced to 0.775 Vrms.

* AD converters are 24-bit linear, 128-times oversampling.

● Analog Output Characteristics

Output Terminals	Actual Source Impedance	For Use With Nominal	Max. Output Level Select SW	Output Level		Connector
				Nominal	Max. before clip	
OUTPUT 1–8	75 Ω	600 Ω Lines	+24 dB (default)	+4 dBu (1.23 V)	+24 dBu (12.3 V)	XLR-3-32 type (Balanced)* ¹
			+18 dB	-2 dBu (616 mV)	+18 dBu (6.16 V)	

*1. XLR-3-32 type connectors are balanced. (1=GND, 2=HOT, 3=COLD)

* In these specifications, when dBu represents a specific voltage, 0 dBu is referenced to 0.775 Vrms.

* DA converters are 24-bit, 128-times oversampling.

● Digital Input/Output Characteristics

Terminal	Format	Data Length	Level	Audio	Connector
EtherSound	IN	24bit	100 Base-TX	8 ch Input/ 16 ch Output	RJ-45* ¹
	OUT				

*1. Use a RJ-45 connector compliant with Neutrik etherCON® CAT5.

* Use a CAT5e STP (Shielded Twisted Pair) cable compliant with EtherSound.

* Use electrically conductive tape to securely connect the metal part of the connector with the shielded part of the cable in order to prevent electromagnetic interference.

* An EtherSound certified cable is recommended. Maximum length available depends on each cable specification.

● Control I/O Characteristics

Terminal	Format	Level	Connector
NETWORK	IEEE802.3	10 Base-T/ 100 Base-TX	RJ-45

* A CAT5e STP (Shielded Twisted Pair) cable is recommended. Maximum length is 100 m.

Electrical Characteristics

Output impedance of single generator: 150Ω
Measured with another SB168-ES through EtherSound

● Frequency Response

Fs= 44.1 kHz or 48 kHz@20 Hz–20 kHz, reference to the nominal output level @ 1 kHz

Input	Output	RL	Conditions	Min.	Typ.	Max.	Unit
INPUT 1–16	OUTPUT 1–8	600 Ω	GAIN: +10dB	-1.5	0	0.5	dB

● Gain Error

Fs= 44.1 kHz, 48 kHz@ 1 kHz

Input	Output	RL	Conditions	Min.	Typ.	Max.	Unit
INPUT 1–16	OUTPUT 1–8	600 Ω	Input level: -62 dBu, GAIN: -62dB → Output level +4.0 dBu (Typ.)	-2	0	2	dB
			Input level: +10 dBu, GAIN: +10dB → Output level +4.0 dBu (Typ.)	-2	0	2	

● Total Harmonic Distortion

Fs= 44.1 kHz or 48 kHz

Input	Output	RL	Conditions	Min.	Typ.	Max.	Unit
INPUT 1–16	OUTPUT 1–8	600 Ω	+4 dBu@20 Hz–20 kHz, GAIN: -62dB			0.1	%
			+4 dBu@20 Hz–20 kHz, GAIN: +10dB			0.05	

* Total Harmonic Distortion is measured with a 18 dB/octave filter @80 kHz.

● Hum & Noise

Fs= 44.1 kHz or 48 kHz, EIN= Equivalent Input Noise

Input	Output	RL	Conditions	Min.	Typ.	Max.	Unit
INPUT 1–16	OUTPUT 1–8	600 Ω	Rs=150Ω, GAIN: -62 dB		-128 EIN		dBu
			Rs=150Ω, GAIN: +10 dB		-62	-84	

* Hum & Noise are measured with a 6 dB/octave filter @ 12.7 kHz; equivalent to a 20 kHz filter with infinite dB/octave attenuation.

● Dynamic Range

Fs= 44.1 kHz or 48 kHz

Input	Output	RL	Conditions	Min.	Typ.	Max.	Unit
INPUT 1–16	OUTPUT 1–8	600 Ω	GAIN: +10dB		108		dB

* Dynamic Range is measured with a 6 dB/octave filter @ 12.7 kHz; equivalent to a 20 kHz filter with infinite dB/octave attenuation.

● Crosstalk @ 1 kHz

Fs= 44.1 kHz or 48 kHz

From/To	To/From	Conditions	Min.	Typ.	Max.	Unit
INPUT N	INPUT (N-1) or (N+1)	INPUT 1–16, adjacent inputs, GAIN: +10dB			-80	dB
OUTPUT N	OUTPUT (N-1) or (N+1)	OUTPUT 1–8, input to output			-80	

● Phantom Voltage

Output	Conditions	Min.	Typ.	Max.	Unit
INPUT 1–16	hot & cold: No load	46	48	50	V

● Sampling Frequency

Parameter	Conditions	Min.	Typ.	Max.	Unit
External Clock	Frequency Range	43.00		49.20	kHz
Internal Clock	Frequency		48		kHz
	Accuracy			50	ppm

Dimensions

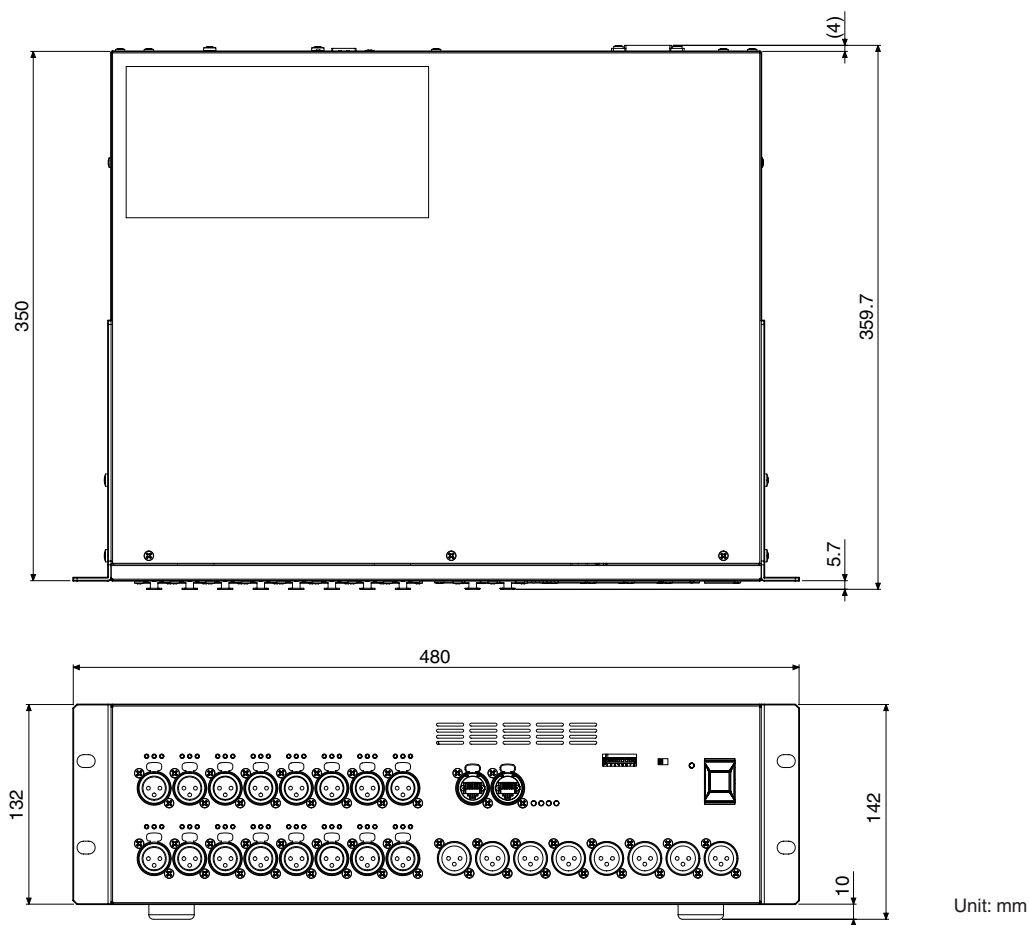

Compatible Host List

Compatible Host	Maximum Usable Units	Maximum Audio Channels	HA Remote Connection
M7CL-48ES	3	48in / 24out	EtherSound connector
M7CL-48	3	48in / 24out	D-sub 9pin
M7CL-32	3	48in / 24out	D-sub 9pin
LS9-32	2	32in / 16out	via MY Card Slot
LS9-16	1	16in / 8out	via MY Card Slot
DM1000	2	32in / 16out	D-sub 9pin
DM2000	4	64in / 32out	D-sub 9pin
PM5D/PM5D-RH	4	64in / 32out	D-sub 9pin
DME64N	4	64in / 32out	D-sub 9pin
DME24N	1	16in / 8out	D-sub 9pin
DME8i-ES/8o-ES/4io-ES	4	64in / 32out	Not supported
02R96	4	64in / 32out	Not supported
01V96	1	16in / 8out	Not supported

* Refer to the Yamaha Pro Audio global website for the most recent information on compatible host controllers.
<http://www.yamahaproaudio.com/>

MEMO

MEMO



EN

Information for Users on Collection and Disposal of Old Equipment

This symbol on the products, packaging, and/or accompanying documents means that used electrical and electronic products should not be mixed with general household waste.

For proper treatment, recovery and recycling of old products, please take them to applicable collection points, in accordance with your national legislation and the Directives 2002/96/EC.

By disposing of these products correctly, you will help to save valuable resources and prevent any potential negative effects on human health and the environment which could otherwise arise from inappropriate waste handling.

For more information about collection and recycling of old products, please contact your local municipality, your waste disposal service or the point of sale where you purchased the items.

[For business users in the European Union]

If you wish to discard electrical and electronic equipment, please contact your dealer or supplier for further information.

[Information on Disposal in other Countries outside the European Union]

This symbol is only valid in the European Union. If you wish to discard these items, please contact your local authorities or dealer and ask for the correct method of disposal.

DE

Verbraucherinformation zur Sammlung und Entsorgung alter Elektrogeräte

Befindet sich dieses Symbol auf den Produkten, der Verpackung und/oder beiliegenden Unterlagen, so sollten benutzte elektrische Geräte nicht mit dem normalen Haushaltsabfall entsorgt werden.

In Übereinstimmung mit Ihren nationalen Bestimmungen und den Richtlinien 2002/96/EC, bringen Sie alte Geräte bitte zur fachgerechten Entsorgung, Wiederaufbereitung und Wiederverwendung zu den entsprechenden Sammelstellen.

Durch die fachgerechte Entsorgung der Elektrogeräte helfen Sie, wertvolle Ressourcen zu schützen und verhindern mögliche negative Auswirkungen auf die menschliche Gesundheit und die Umwelt, die andernfalls durch unsachgerechte Müllentsorgung auftreten könnten.

Für weitere Informationen zum Sammeln und Wiederaufbereiten alter Elektrogeräte, kontaktieren Sie bitte Ihre örtliche Stadt- oder Gemeindeverwaltung, Ihren Abfallentsorgungsdienst oder die Verkaufsstelle der Artikel.

[Information für geschäftliche Anwender in der Europäischen Union]

Wenn Sie Elektrogeräte ausrangieren möchten, kontaktieren Sie bitte Ihren Händler oder Zulieferer für weitere Informationen.

[Entsorgungsinformation für Länder außerhalb der Europäischen Union]

Dieses Symbol gilt nur innerhalb der Europäischen Union. Wenn Sie solche Artikel ausrangieren möchten, kontaktieren Sie bitte Ihre örtlichen Behörden oder Ihren Händler und fragen Sie nach der sachgerechten Entsorgungsmethode.

FR

Information concernant la Collecte et le Traitement des déchets d'équipements électriques et électroniques

Le symbole sur les produits, l'emballage et/ou les documents joints signifie que les produits électriques ou électroniques usagés ne doivent pas être mélangés avec les déchets domestiques habituels.

Pour un traitement, une récupération et un recyclage appropriés des déchets d'équipements électriques et électroniques, veuillez les déposer aux points de collecte prévus à cet effet, conformément à la réglementation nationale et aux Directives 2002/96/EC.

En vous débarrassant correctement des déchets d'équipements électriques et électroniques, vous contribuerez à la sauvegarde de précieuses ressources et à la prévention de potentiels effets négatifs sur la santé humaine qui pourraient advenir lors d'un traitement inapproprié des déchets.

Pour plus d'informations à propos de la collecte et du recyclage des déchets d'équipements électriques et électroniques, veuillez contacter votre municipalité, votre service de traitement des déchets ou le point de vente où vous avez acheté les produits.

[Pour les professionnels dans l'Union Européenne]

Si vous souhaitez vous débarrasser des déchets d'équipements électriques et électroniques veuillez contacter votre vendeur ou fournisseur pour plus d'informations.

[Information sur le traitement dans d'autres pays en dehors de l'Union Européenne]

Ce symbole est seulement valable dans l'Union Européenne. Si vous souhaitez vous débarrasser de déchets d'équipements électriques et électroniques, veuillez contacter les autorités locales ou votre fournisseur et demander la méthode de traitement appropriée.

ES

Información para Usuarios sobre Recolección y Disposición de Equipamiento Viejo

Este símbolo en los productos, embalaje, y/o documentación que se acompañe significa que los productos electrónicos y eléctricos usados no deben ser mezclados con desechos hogareños corrientes.

Para el tratamiento, recuperación y reciclado apropiado de los productos viejos, por favor llévelos a puntos de recolección aplicables, de acuerdo a su legislación nacional y las directivas 2002/96/EC.

Al disponer de estos productos correctamente, ayudará a ahorrar recursos valiosos y a prevenir cualquier potencial efecto negativo sobre la salud humana y el medio ambiente, el cual podría surgir de un inapropiado manejo de los desechos.

Para mayor información sobre recolección y reciclado de productos viejos, por favor contacte a su municipio local, su servicio de gestión de residuos o el punto de venta en el cual usted adquirió los artículos.

[Para usuarios de negocios en la Unión Europea]

Si usted desea deshacerse de equipamiento eléctrico y electrónico, por favor contacte a su vendedor o proveedor para mayor información.

[Información sobre la Disposición en otros países fuera de la Unión Europea]

Este símbolo sólo es válidos en la Unión Europea. Si desea deshacerse de estos artículos, por favor contacte a sus autoridades locales y pregunte por el método correcto de disposición.

IT

Informazioni per gli utenti sulla raccolta e lo smaltimento di vecchia attrezzatura

Questo simbolo sui prodotti, sull'imballaggio, e/o sui documenti che li accompagnano significa che i prodotti elettriche e elettroniche non dovrebbero essere mischiati con i rifiuti domestici generici.

Per il trattamento, recupero e riciclaggio appropriati di vecchi prodotti, li porti, prego, ai punti di raccolta appropriati, in accordo con la Sua legislazione nazionale e le direttive 2002/96/CE.

Smaltendo correttamente questi prodotti, Lei aiuterà a salvare risorse preziose e a prevenire alcuni potenziali effetti negativi sulla salute umana e l'ambiente, che altrimenti potrebbero sorgere dal trattamento improprio dei rifiuti.

Per ulteriori informazioni sulla raccolta e il riciclaggio di vecchi prodotti, prego contatti la Sua amministrazione comunale locale, il Suo servizio di smaltimento dei rifiuti o il punto vendita dove Lei ha acquistato gli articoli.

[Per utenti imprenditori dell'Unione europea]

Se Lei desidera disfarsi di attrezzatura elettrica ed elettronica, prego contatti il Suo rivenditore o fornitore per ulteriori informazioni.

[Informazioni sullo smaltimento negli altri Paesi al di fuori dell'Unione europea]

Questo simbolo è validi solamente nell'Unione europea. Se Lei desidera disfarsi di questi articoli, prego contatti le Sue autorità locali o il rivenditore e richieda la corretta modalità di smaltimento.

FCC INFORMATION (U.S.A.)

1. IMPORTANT NOTICE: DO NOT MODIFY THIS UNIT!

This product, when installed as indicated in the instructions contained in this manual, meets FCC requirements. Modifications not expressly approved by Yamaha may void your authority, granted by the FCC, to use the product.

2. IMPORTANT: When connecting this product to accessories and/or another product use only high quality shielded cables. Cable/s supplied with this product **MUST** be used. Follow all installation instructions. Failure to follow instructions could void your FCC authorization to use this product in the USA.

3. NOTE: This product has been tested and found to comply with the requirements listed in FCC Regulations, Part 15 for Class "B" digital devices. Compliance with these requirements provides a reasonable level of assurance that your use of this product in a residential environment will not result in harmful interference with other electronic devices. This equipment generates/uses radio frequencies and, if not installed and used according to the instructions found in the users manual, may cause interference harmful to the opera-

tion of other electronic devices. Compliance with FCC regulations does not guarantee that interference will not occur in all installations. If this product is found to be the source of interference, which can be determined by turning the unit "OFF" and "ON", please try to eliminate the problem by using one of the following measures:

Relocate either this product or the device that is being affected by the interference.

Utilize power outlets that are on different branch (circuit breaker or fuse) circuits or install AC line filter/s.

In the case of radio or TV interference, relocate/reorient the antenna. If the antenna lead-in is 300 ohm ribbon lead, change the lead-in to co-axial type cable.

If these corrective measures do not produce satisfactory results, please contact the local retailer authorized to distribute this type of product. If you can not locate the appropriate retailer, please contact Yamaha Corporation of America, Electronic Service Division, 6600 Orangethorpe Ave, Buena Park, CA90620

The above statements apply **ONLY** to those products distributed by Yamaha Corporation of America or its subsidiaries.

* This applies only to products distributed by YAMAHA CORPORATION OF AMERICA.

(class B)

COMPLIANCE INFORMATION STATEMENT (DECLARATION OF CONFORMITY PROCEDURE)

Responsible Party : Yamaha Corporation of America
Address : 6600 Orangethorpe Ave., Buena Park,
Calif. 90620
Telephone : 714-522-9011
Type of Equipment : STAGE BOX
Model Name : SB168-ES

This device complies with Part 15 of the FCC Rules.

Operation is subject to the following two conditions:

- 1) this device may not cause harmful interference, and
- 2) this device must accept any interference received including interference that may cause undesired operation.

See user manual instructions if interference to radio reception is suspected.

* This applies only to products distributed by
YAMAHA CORPORATION OF AMERICA.

(FCC DoC)

This product contains a battery that contains perchlorate material.

Perchlorate Material—special handling may apply,
See www.dtsc.ca.gov/hazardouswaste/perchlorate.

* This applies only to products distributed by
YAMAHA CORPORATION OF AMERICA.

(Perchlorate)

ADVARSEL!

Lithiumbatteri—Eksplodingsfare ved fejlagtig håndtering. Udskiftning må kun ske med batteri af samme fabrikat og type. Levér det brugte batteri tilbage til leverandoren.

VARNING

Explosionsfara vid felaktigt batteribyte. Använd samma batterityp eller en ekvivalent typ som rekommenderas av apparattillverkaren. Kassera använt batteri enligt fabrikantens instruktion.

VAROITUS

Paristo voi räjähtää, jos se on virheellisesti asennettu. Vaihda paristo ainoastaan laitevalmistajan suosittelemaan tyyppiin. Hävitä käytetty paristo valmistajan ohjeiden mukaisesti.

(lithium caution)

IMPORTANT NOTICE FOR THE UNITED KINGDOM Connecting the Plug and Cord

WARNING: THIS APPARATUS MUST BE EARTHED
IMPORTANT. The wires in this mains lead are coloured in accordance with the following code:

GREEN-AND-YELLOW : EARTH
BLUE : NEUTRAL
BROWN : LIVE

As the colours of the wires in the mains lead of this apparatus may not correspond with the coloured markings identifying the terminals in your plug proceed as follows:

The wire which is coloured GREEN-and-YELLOW must be connected to the terminal in the plug which is marked by the letter E or by the safety earth symbol  or colored GREEN or GREEN-and-YELLOW.

The wire which is coloured BLUE must be connected to the terminal which is marked with the letter N or coloured BLACK.

The wire which is coloured BROWN must be connected to the terminal which is marked with the letter L or coloured RED.

• This applies only to products distributed by
Yamaha Music U.K. Ltd.

(3 wires)

NEDERLAND / THE NETHERLANDS

- Dit apparaat bevat een lithium batterij voor geheugen back-up.
- This apparatus contains a lithium battery for memory back-up.
- Raadpleeg uw leverancier over de verwijdering van de batterij op het moment dat u het apparaat aan het einde van de levensduur of gelieve dan contact op te nemen met de vertegenwoordiging van Yamaha in uw land.
- For the removal of the battery at the moment of the disposal at the end of life please consult your retailer or Yamaha representative office in your country.
- Gooi de batterij niet weg, maar lever hem in als KCA.
- Do not throw away the battery. Instead, hand it in as small chemical waste.

(lithium disposal)

For details of products, please contact your nearest Yamaha representative or the authorized distributor listed below.

Pour plus de détails sur les produits, veuillez-vous adresser à Yamaha ou au distributeur le plus proche de vous figurant dans la liste suivante.

Die Einzelheiten zu Produkten sind bei Ihrer unten aufgeführten Niederlassung und bei Yamaha Vertragshändlern in den jeweiligen Bestimmungsländern erhältlich.

Para detalles sobre productos, contacte su tienda Yamaha más cercana o el distribuidor autorizado que se lista debajo.

NORTH AMERICA

CANADA

Yamaha Canada Music Ltd.
135 Milner Avenue, Toronto, Ontario,
M1S 3R1, Canada
Tel: 416-298-1311

U.S.A.

Yamaha Corporation of America
6600 Orangethorpe Avenue, Buena Park, CA 90620,
U.S.A.
Tel: 714-522-9011

CENTRAL & SOUTH AMERICA

MEXICO

Yamaha de México, S.A. de C.V.
Av. Insurgentes Sur 1647 Piso 9, Col. San José
Insurgentes, Delegación Benito Juárez, México,
D.F., C.P. 03900
Tel: 55-5804-0600

BRAZIL

Yamaha Musical do Brasil Ltda.
Rua Joaquim Floriano, 913 - 4º andar, Itaim Bibi,
CEP 04534-013 São Paulo, SP. BRAZIL
Tel: 011-3704-1377

ARGENTINA

**Yamaha Music Latin America, S.A.,
Sucursal Argentina**
Olga Cossettini 1553, Piso 4 Norte,
Madero Este-C1107CEK
Buenos Aires, Argentina
Tel: 011-4119-7000

VENEZUELA

**Yamaha Music Latin America, S.A.,
Sucursal Venezuela**
C.C. Manzanares Plaza P4
Ofic. 0401- Manzanares-Baruta
Caracas Venezuela
Tel: 58-212-943-1877

PANAMA AND OTHER LATIN AMERICAN COUNTRIES/ CARIBBEAN COUNTRIES

Yamaha Music Latin America, S.A.
Torre Banco General, Piso No.7, Marbella,
Calle 47 y Aquilino de la Guardia,
Ciudad de Panamá, República de Panamá
Tel: +507-269-5311

EUROPE

THE UNITED KINGDOM/IRELAND

Yamaha Music Europe GmbH (UK)
Sherbourne Drive, Tilbrook, Milton Keynes,
MK7 8BL, U.K.
Tel: 01908-366700

GERMANY

Yamaha Music Europe GmbH
Siemensstraße 22-34, 25462 Rellingen, Germany
Tel: 04101-3030

SWITZERLAND/LIECHTENSTEIN

**Yamaha Music Europe GmbH
Branch Switzerland in Zürich**
Seefeldstrasse 94, 8008 Zürich, Switzerland
Tel: 044-387-8080

AUSTRIA/BULGARIA

Yamaha Music Europe GmbH Branch Austria
Schleiergasse 20, A-1100 Wien, Austria
Tel: 01-60203900

CZECH REPUBLIC/HUNGARY/ ROMANIA/SLOVAKIA/SLOVENIA

**Yamaha Music Europe GmbH
Branch Austria (Central Eastern Europe Office)**
Schleiergasse 20, A-1100 Wien, Austria
Tel: 01-60203900

POLAND/LITHUANIA/LATVIA/ESTONIA

**Yamaha Music Europe GmbH
Branch Poland Office**
ul. Wrotkowa 14 02-553 Warsaw, Poland
Tel: 022-500-2925

MALTA

Olimpus Music Ltd.
The Emporium, Level 3, St. Louis Street Msida
MSD06
Tel: 02133-2144

NETHERLANDS/BELGIUM/ LUXEMBOURG

Yamaha Music Europe Branch Benelux
Clarissenhof 5-b, 4133 AB Vianen, Netherlands
Tel: 0347-358 040

FRANCE

Yamaha Music Europe
7 rue Ambroise Croizat, Zone d'activites Pariest,
77183 Croissy-Beaubourg, France
Tel: 01-64-61-4000

ITALY

Yamaha Music Europe GmbH, Branch Italy
Viale Italia 88, 20020 Lainate (Milano), Italy
Tel: 02-935-771

SPAIN/PORTUGAL

**Yamaha Music Europe GmbH Ibérica, Sucursal
en España**
Ctra. de la Coruna km. 17,200, 28231
Las Rozas (Madrid), Spain
Tel: +34-91-639-88-88

GREECE

Philippos Nakas S.A. The Music House
147 Skiathou Street, 112-55 Athens, Greece
Tel: 01-228 2160

SWEDEN/FINLAND/ICELAND

**Yamaha Music Europe GmbH Germany filial
Scandinavia**
J. A. Wettergrensgata 1, Box 30053
S-400 43 Göteborg, Sweden
Tel: +46 31 89 34 00

DENMARK

**Yamaha Music Europe GmbH, Tyskland – filial
Denmark**
Generatorvej 6A, DK-2730 Herlev, Denmark
Tel: 44 92 49 00

NORWAY

**Yamaha Music Europe GmbH Germany -
Norwegian Branch**
Grini Næringspark 1, N-1361 Østerås, Norway
Tel: 67 16 78 00

RUSSIA

Yamaha Music (Russia) LLC.
Room 37, bld. 7, Kievskaya street, Moscow,
121059, Russia
Tel: 495 626 5005

OTHER EUROPEAN COUNTRIES

Yamaha Music Europe GmbH
Siemensstraße 22-34, 25462 Rellingen, Germany
Tel: +49-4101-3030

AFRICA

Yamaha Music Gulf FZE
Office JAFZA 16-512, P.O.Box 17328,
Jebel Ali - Dubai, UAE
Tel: +971-4-881-5868

MIDDLE EAST

TURKEY

**Yamaha Music Europe GmbH
Merkezi Almanya Türkiye İstanbul Şubesi**
Maslak Meydan Sokak No:5 Spring Giz Plaza
Bağımsız Böl. No:3, 34398 Şişli İstanbul
Tel: +90-212-999-8010

CYPRUS

Yamaha Music Europe GmbH
Siemensstraße 22-34, 25462 Rellingen, Germany
Tel: 04101-3030

OTHER COUNTRIES

Yamaha Music Gulf FZE
Office JAFZA 16-512, P.O.Box 17328,
Jebel Ali - Dubai, U.A.E
Tel: +971-4-881-5868

ASIA

THE PEOPLE'S REPUBLIC OF CHINA

Yamaha Music & Electronics (China) Co.,Ltd.
2F, Yunhedasha, 1818 Xinzha-lu, Jingan-qu,
Shanghai, China
Tel: 021-6247-2211

INDIA

Yamaha Music India Pvt. Ltd.
Spazedge building, Ground Floor, Tower A, Sector
47, Gurgaon- Sohna Road, Gurgaon, Haryana, India
Tel: 0124-485-3300

INDONESIA

PT. Yamaha Musik Indonesia (Distributor)
Yamaha Music Center Bldg. Jalan Jend. Gatot
Subroto Kav. 4, Jakarta 12930, Indonesia
Tel: 021-520-2577

KOREA

Yamaha Music Korea Ltd.
8F, 9F, Dongsung Bldg. 158-9 Samsung-Dong,
Kangnam-Gu, Seoul, Korea
Tel: 02-3467-3300

MALAYSIA

Yamaha Music (Malaysia) Sdn., Bhd.
No.8, Jalan Perbandaran, Kelana Jaya, 47301
Petaling Jaya, Selangor, Malaysia
Tel: 03-78030900

SINGAPORE

Yamaha Music (Asia) Private Limited
Block 202 Hougang Street 21, #02-00,
Singapore 530202, Singapore
Tel: 65-6747-4374

TAIWAN

Yamaha Music & Electronics Taiwan Co.,Ltd.
3F, No.6, Section 2 Nan-Jing East Road, Taipei,
Taiwan R.O.C.
Tel: 02-2511-8688

THAILAND

Siam Music Yamaha Co., Ltd.
3, 4, 15 and 16th floor, Siam Motors Building,
891/1 Rama 1 Road, Wangmai,
Pathumwan, Bangkok 10330, Thailand
Tel: 02-215-2622

VIETNAM

Yamaha Music Vietnam Company Limited
15th Floor, Nam A Bank Tower, 201-203 Cach
Mang Thang Tam St., Ward 4, Dist.3,
Ho Chi Minh City, Vietnam
Tel: +84-8-3818-1122

OTHER ASIAN COUNTRIES

**Yamaha Corporation
Sales & Marketing Division**
Nakazawa-cho 10-1, Naka-ku, Hamamatsu,
Japan 430-8650
Tel: +81-53-460-2312

OCEANIA

AUSTRALIA

Yamaha Music Australia Pty. Ltd.
Level 1, 99 Queensbridge Street, Southbank,
Victoria 3006, Australia
Tel: 3-9693-5111

COUNTRIES AND TRUST TERRITORIES IN PACIFIC OCEAN

**Yamaha Corporation
Sales & Marketing Division**
Nakazawa-cho 10-1, Naka-ku, Hamamatsu,
Japan 430-8650
Tel: +81-53-460-2312



Yamaha Pro Audio global web site:
<http://www.yamahaproaudio.com/>

Yamaha Manual Library
<http://www.yamaha.co.jp/manual/>

C.S.G., PA Development Division
© 2008-2013 Yamaha Corporation

311POTO-E0
Printed in Japan

WP93760