

YAMAHA

YST-SW300

Active Servo Processing Subwoofer System

Enceinte pour très basses fréquences de traitement à asservissement actif

Thank you for selecting this YAMAHA Subwoofer System.

*Nous vous remercions d'avoir porté votre choix sur cette enceinte
pour très basses fréquences YAMAHA.*



**OWNER'S MANUAL
MODE D'EMPLOI**

SAFETY INSTRUCTIONS

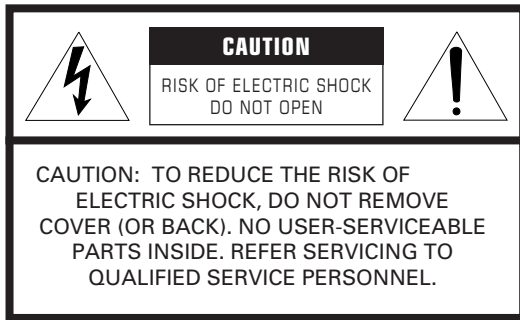

• Explanation of Graphical Symbols

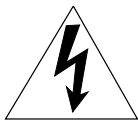

The lightning flash with arrowhead symbol, within an equilateral triangle, is intended to alert you to the presence of uninsulated "dangerous voltage" within the product's enclosure that may be of sufficient magnitude to constitute a risk of electric shock to persons.



The exclamation point within an equilateral triangle is intended to alert you to the presence of important operating and maintenance (servicing) instructions in the literature accompanying the appliance.

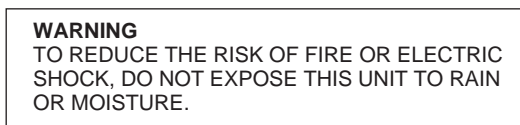

- 1 Read Instructions – All the safety and operating instructions should be read before the unit is operated.
- 2 Retain Instructions – The safety and operating instructions should be retained for future reference.
- 3 Heed Warnings – All warnings on the unit and in the operating instructions should be adhered to.
- 4 Follow Instructions – All operating and other instructions should be followed.
- 5 Water and Moisture – The unit should not be used near water – for example, near a bathtub, washbowl, kitchen sink, laundry tub, in a wet basement, or near a swimming pool, etc.
- 6 Carts and Stands – The unit should be used only with a cart or stand that is recommended by the manufacturer.
- 6A A unit and cart combination should be moved with care. Quick stops, excessive force, and uneven surfaces may cause the unit and cart combination to overturn.



- 7 Wall or Ceiling Mounting – The unit should be mounted to a wall or ceiling only as recommended by the manufacturer.
- 8 Ventilation – The unit should be situated so that its location or position does not interfere with its proper ventilation. For example, the unit should not be situated on a bed, sofa, rug, or similar surface, that may block the ventilation openings; or placed in a built-in installation, such as a bookcase or cabinet that may impede the flow of air through the ventilation openings.
- 9 Heat – The unit should be situated away from heat sources such as radiators, stoves, or other appliances that produce heat.
- 10 Power Sources – The unit should be connected to a power supply only of the type described in the operating instructions or as marked on the unit.
- 11 Power-Cord Protection – Power-supply cords should be routed so that they are not likely to be walked on or pinched by items placed upon or against them, paying particular attention to cords at plugs, convenience receptacles, and the point where they exit from the unit.
- 12 Cleaning – The unit should be cleaned only as recommended by the manufacturer.
- 13 Nonuse Periods – The power cord of the unit should be unplugged from the outlet when left unused for a long period of time.
- 14 Object and Liquid Entry – Care should be taken so that objects do not fall into and liquids are not spilled into the inside of the unit.
- 15 Damage Requiring Service – The unit should be serviced by qualified service personnel when:
 - A. The power-supply cord or the plug has been damaged; or
 - B. Objects have fallen, or liquid has been spilled into the unit; or
 - C. The unit has been exposed to rain; or
 - D. The unit does not appear to operate normally or exhibits a marked change in performance; or
 - E. The unit has been dropped, or the cabinet damaged.
- 16 Servicing – The user should not attempt to service the unit beyond those means described in the operating instructions. All other servicing should be referred to qualified service personnel.
- 17 Power Lines – An outdoor antenna should be located away from power lines.
- 18 Grounding or Polarization – Precautions should be taken so that the grounding or polarization is not defeated.

FCC INFORMATION (for US customers only)

1. IMPORTANT NOTICE : DO NOT MODIFY THIS UNIT!

This product, when installed as indicated in the instructions contained in this manual, meets FCC requirements. Modifications not expressly approved by Yamaha may void your authority, granted by the FCC, to use the product.

2. IMPORTANT : When connecting this product to accessories and/or another product use only high quality shielded cables. Cable/s supplied with this product MUST be used. Follow all installation instructions. Failure to follow instructions could void your FCC authorization to use this product in the USA.

3. NOTE : This product has been tested and found to comply with the requirements listed in FCC Regulations, Part 15 for Class "B" digital devices. Compliance with these requirements provides a reasonable level of assurance that your use of this product in a residential environment will not result in harmful interference with other electronic devices.

This equipment generates/uses radio frequencies and, if not installed and used according to the instructions found in the users manual, may cause interference harmful to the operation of other electronic devices.

Compliance with FCC regulations does not guarantee that interference will not occur in all installations. If this product is found to be the source of interference, which can be determined by turning the unit "OFF" and "ON", please try to eliminate the problem by using one of the following measures:

Relocate either this product or the device that is being affected by the interference.

Utilize power outlets that are on different branch (circuit breaker or fuse) circuits or install AC line filter/s.

In the case of radio or TV interference, relocate/reorient the antenna. If the antenna lead-in is 300 ohm ribbon lead, change the lead-in to coaxial type cable.

If these corrective measures do not produce satisfactory results, please contact the local retailer authorized to distribute this type of product. If you can not locate the appropriate retailer, please contact Yamaha Electronics Corp., U.S.A. 6660 Orangethorpe Ave, Buena Park, CA 90620.

The above statements apply ONLY to those products distributed by Yamaha Corporation of America or its subsidiaries.

We Want You Listening For A Lifetime (for US customers only)

YAMAHA and the Electronic Industries Association's Consumer Electronics Group want you to get the most out of your equipment by playing it at a safe level. One that lets the sound come through loud and clear without annoying blaring or distortion – and, most importantly, without affecting your sensitive hearing. Since hearing damage from loud sounds is

often undetectable until it is too late, YAMAHA and the Electronic Industries Association's Consumer Electronics Group recommend you to avoid prolonged exposure from excessive volume levels.



CONTENTS

Caution	4	Adjusting volume	13
Features	5	Active Servo Technology	15
Placement	5	Troubleshooting	16
Connections	6	Specifications	16
Controls and their functions	11		

CAUTION: READ THIS BEFORE OPERATING YOUR UNIT.

1. To assure the finest performance, please read this manual carefully. Keep it in a safe place for future reference.
2. Install this unit in a cool, dry, clean place – away from windows, heat sources, sources of excessive vibration, dust, moisture and cold. Avoid sources of humming (transformers, motors). To prevent fire or electrical shock, do not expose the unit to rain or water.
3. Never open the cabinet. If something drops into the set, contact your dealer.
4. Do not use force on switches, controls or connection wires. When moving the unit, first disconnect the power plug and the wires connected to other equipment. Never pull the wire itself.
5. Do not attempt to clean the unit with chemical solvents; this might damage the finish. Use a clean, dry cloth.
6. Be sure to read the “TROUBLESHOOTING” section regarding common operating errors before concluding that the unit is faulty.
7. When not planning to use this unit for long periods of time (ie., vacation, etc.), disconnect the AC power plug from the wall outlet.
8. To prevent lightning damage, disconnect the AC power plug when there is an electrical storm.
9. Since this unit has a built-in power amplifier, heat will radiate from the rear panel. Therefore, place the unit apart from the walls, allowing a space of at least 20 cm (7-7/8”) above, behind and on the both sides of the unit. Also, do not position with the rear panel facing down on the floor or other surface.
10. Super-bass frequencies reproduced by this unit may cause a turntable to generate a howling sound. In such a case, move this unit away from the turntable.
11. As this speaker contains strong magnet, avoid placing watches, magnetic tapes, etc. near this unit. Also, placing the speaker near a TV set may impair picture color. If this happens, move the TV set away from the speaker.
12. If you hear distortion (i.e., unnatural, intermittent “rapping” or “hammering” sounds) coming from this unit, reduce the volume level. Extremely loud playing of a movie soundtrack’s low frequency, bass-heavy sounds or similarly loud popular music passages can damage this speaker system.
13. This unit has a port called “air woofer” which is for reproducing a super-bass sound.
Be careful not to put a hand or some objects into the port, otherwise it may give you an electric shock or give this unit a damage, or cause a fire.
14. **Voltage Selector (General Model only)**
The voltage selector on the rear panel of this unit must be set for your local main voltage BEFORE plugging into the AC main supply.
Voltages are AC 110/120/220/240V, 50/60 Hz.

IMPORTANT

Please record the serial number of this unit in the space below.

Serial No.:

The serial number is located on the rear of the unit.
Retain this Owner’s Manual in a safe place for future reference.

WARNING

TO REDUCE THE RISK OF FIRE OR ELECTRIC SHOCK, DO NOT EXPOSE THIS UNIT TO RAIN OR MOISTURE.

CAUTION (FOR CANADA MODEL)

TO PREVENT ELECTRIC SHOCK, MATCH WIDE BLADE OF PLUG TO WIDE SLOT AND FULLY INSERT.

FOR CANADIAN CUSTOMER

THIS CLASS B DIGITAL APPARATUS MEETS ALL REQUIREMENTS OF THE CANADIAN INTERFERENCE-CAUSING EQUIPMENT REGULATIONS.

For U.K. customers

If the socket outlets in the home are not suitable for the plug supplied with this appliance, it should be cut off and an appropriate 3 pin plug fitted. For details, refer to the instructions described below.

Note: The plug severed from the mains lead must be destroyed, as a plug with bared flexible cord is hazardous if engaged in a live socket outlet.

SPECIAL INSTRUCTIONS FOR U.K. MODEL

IMPORTANT

THE WIRES IN THE MAINS LEAD ARE COLOURED IN ACCORDANCE WITH THE FOLLOWING CODE:

Blue: NEUTRAL
Brown: LIVE

As the colours of the wires in the mains lead of this apparatus may not correspond with the coloured markings identifying the terminals in your plug, proceed as follows:
The wire which is coloured BLUE must be connected to the terminal which is marked with the letter N or coloured BLACK. The wire which is coloured BROWN must be connected to the terminal which is marked with the letter L or coloured RED. Making sure that neither core is connected to the earth terminal of the three pin plug.

The apparatus is not disconnected from the AC power source as long as it is connected to the wall outlet, even if the apparatus itself is turned off.

FEATURES

- This subwoofer system employs YAMAHA Active Servo Technology which YAMAHA developed for reproducing higher quality super-bass sound. (Refer to page 15 for details on Active Servo Technology.)

This unit does not only enhance bass frequency response of sound output in your audio system, but, by reproducing the bass frequencies, the subwoofer permits your existing amplifier and speakers to operate under less strenuous conditions, improving overall system performance.

- This unit can be added easily to your existing audio system by connecting to either the speaker terminals or the line output (pin jack) terminals of the amplifier.

- The use of the H.P.F. OUTPUT terminals for connecting with the amplifier is effective for improving sound quality of your speaker system. This connection prevents sound output from the main speakers from muddying by filtering out low frequencies of input signals to be sent to the main speakers which are not suitable for reproducing low frequencies.
- For the effective use of this unit, this unit's super-bass sound must be matched to the sounds of your main speakers. Therefore, this unit employs a continuously variable high frequency cut-off point (HIGH CUT) control. Moreover, the PHASE switch allows you to select the best sound quality for various listening conditions.
- A newly employed AUTO POWER ON/OFF switch saves you the trouble of pressing the POWER switch when turning the power on and off.

PLACEMENT

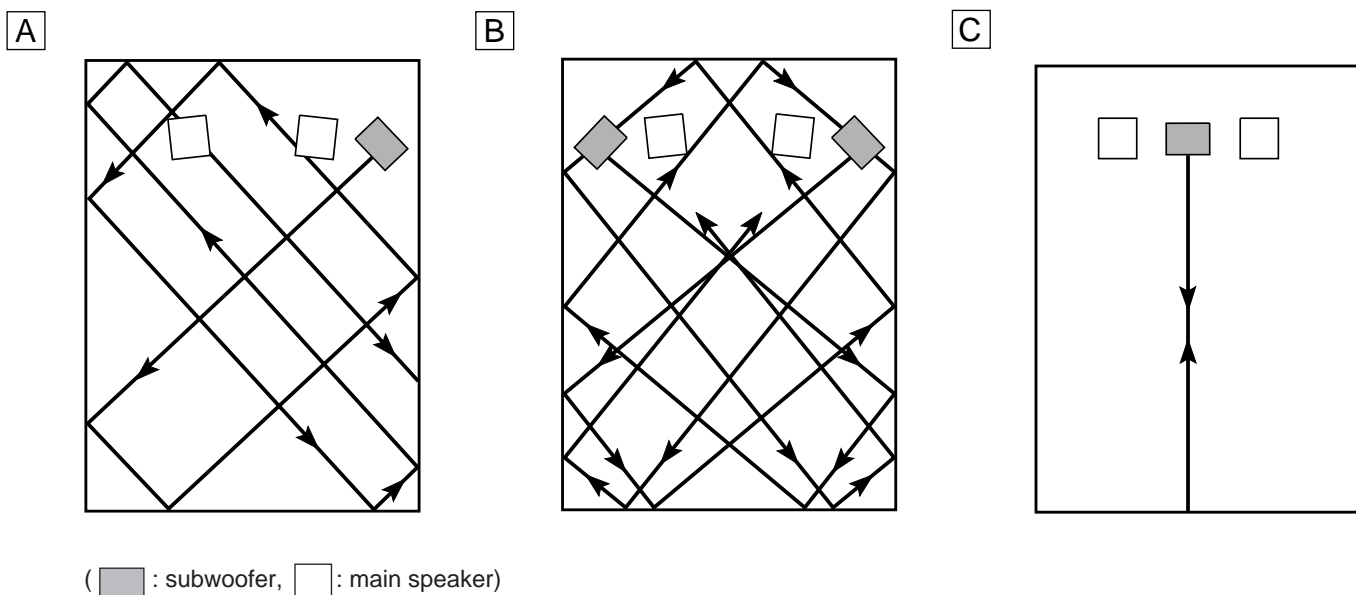

If using one subwoofer, it is recommended to place it on the outside of either the right or the left main speaker. (See fig. **A**.) If using two subwoofers, it is recommended to place them on the outside of each main speaker. (See fig. **B**.) The placement shown in fig. **C** is also possible, however, if the subwoofer system is placed directly facing the wall, the bass effect may die because the sound from it and the sound reflected by the wall may cancel. To prevent this, face the subwoofer system obliquely to the wall as shown in fig. **A** or **B**.

One subwoofer will have a good effect on your audio system, however, the use of two subwoofers is recommended to obtain more presence.

Note

There may be a case that you cannot obtain enough super-bass sounds from this unit when listening at the middle of the room. This is because "standing waves" have developed between two parallel walls and the bass sounds are being canceled.

In such a case, face the unit obliquely to the wall. It also may be necessary to break up the parallel surfaces by placing bookshelves etc. along the walls.

CONNECTIONS

- Before attempting to make any connections to or from this unit, be sure to first switch OFF the power to this unit and to any other components to which connections are being made.
- When making connections between this unit and other components, be sure all connections are made correctly and consistently, that is to say L (left) to L, R (right) to R, “+” to “+” and “-” to “-”.
- This unit can be connected to either the speaker terminals or the line output (pin jack) terminals of the amplifier. Choose one of the ways shown below which is suitable for your audio system. Also, refer to the owner’s manual for each component to be connected to this unit.

CONNECTING TO SPEAKER TERMINALS OF THE AMPLIFIER

Disconnect your main speakers from the amplifier and connect them to this unit.

To connect one unit only

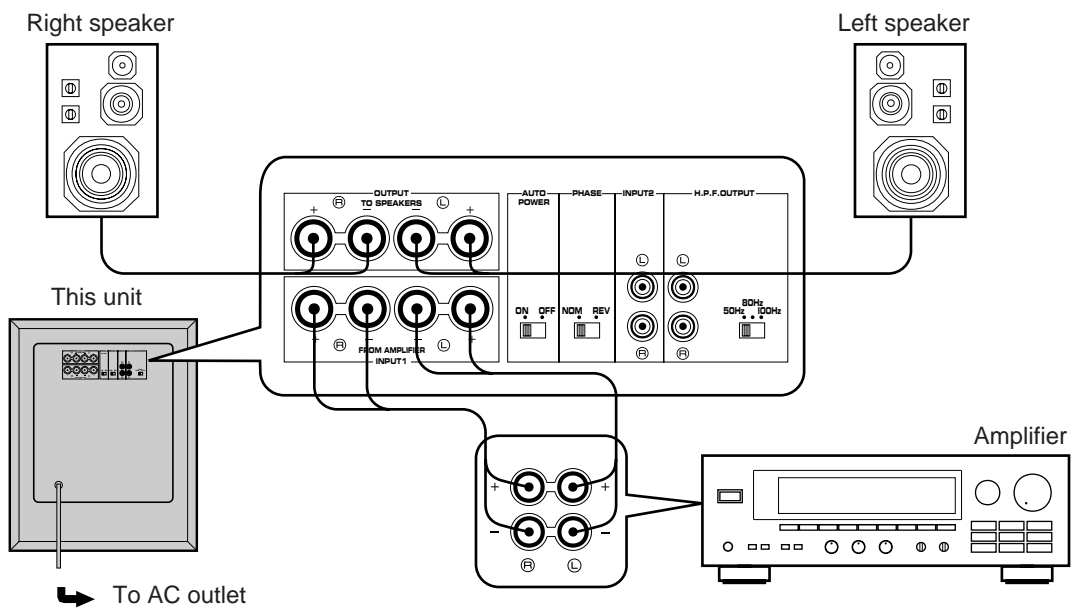

To connect two units

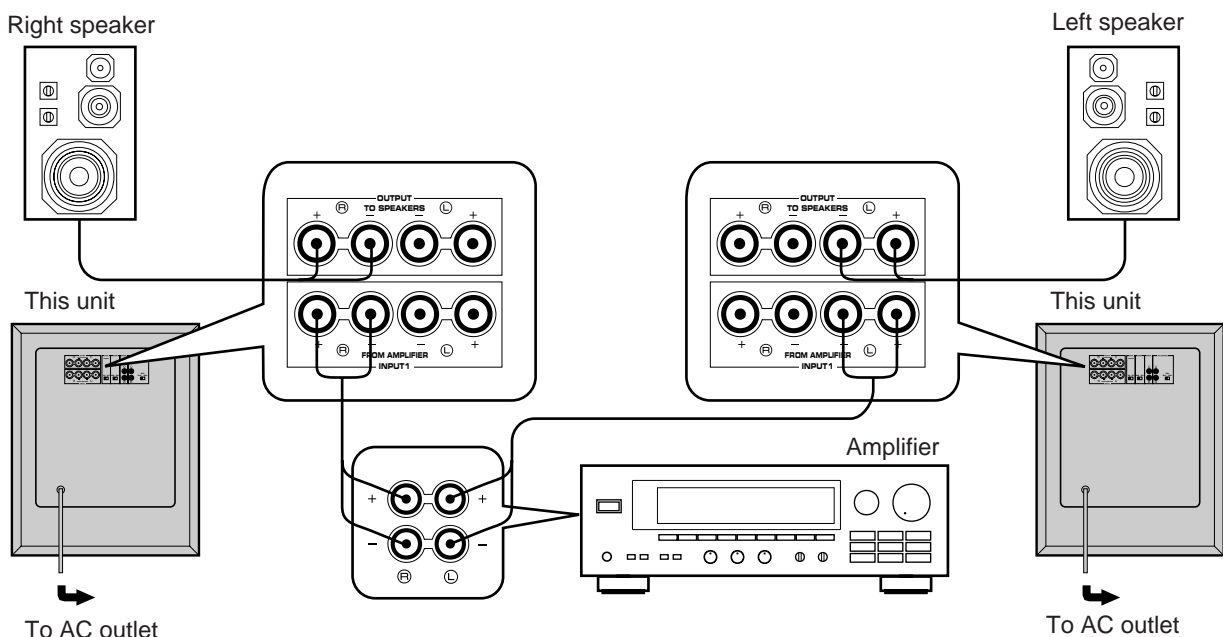

If your amplifier has two sets of speaker terminals

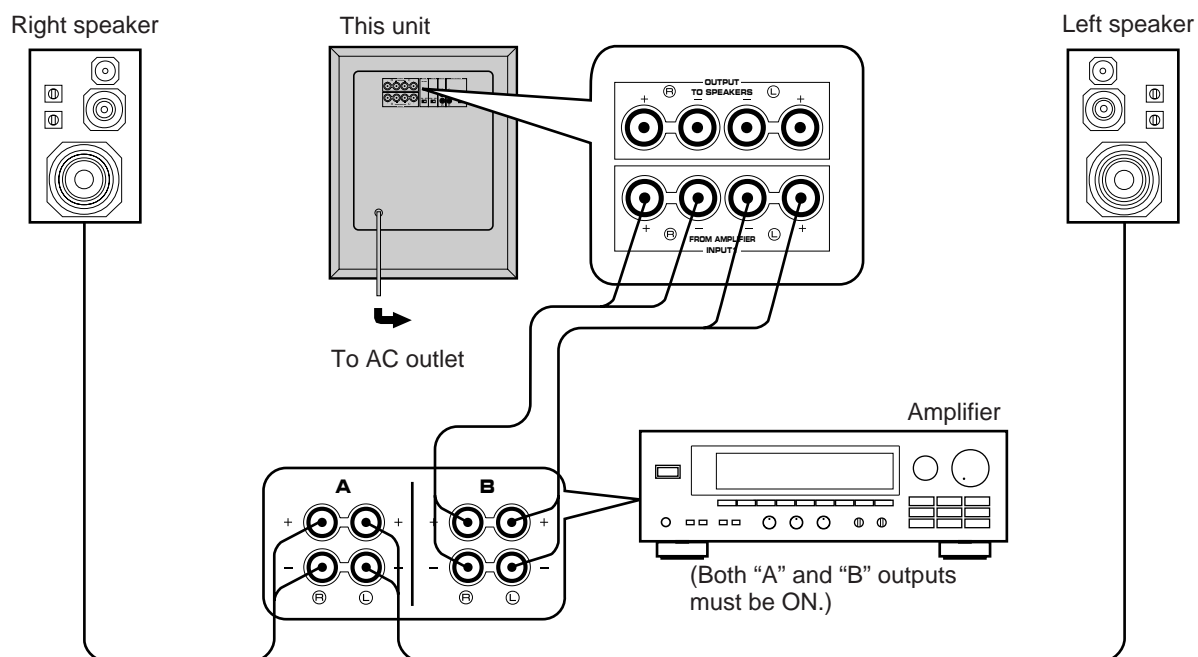

Connecting to this unit's OUTPUT/INPUT terminals

For connections, cut the speaker wires as short as possible. If the connections are faulty, no sound will be heard from the speakers. Make sure that the polarity of the speaker wires is correct, that is, + and – markings are observed. If these wires are reversed, the sound will be unnatural and will lack bass.

Do not let the bare speaker wires touch each other and do not let them touch the metal parts of this unit as this could damage this unit, your amplifier and/or speakers.

* Banana Plug connections are also possible (except for U.K. and Europe models). Simply insert the Banana Plug connector into the corresponding terminal.

How to Connect:

Red: positive (+)
Black: negative (–)

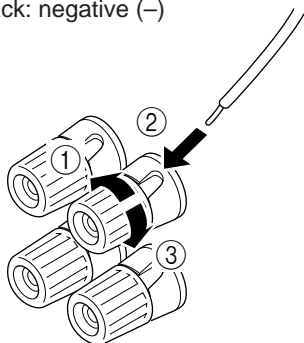

- ① Unscrew the knob.
- ② Insert the bare wire.
[Remove approx. 5mm (1/4") insulation from the speaker wires.]
- ③ Tighten the knob and secure the wire.

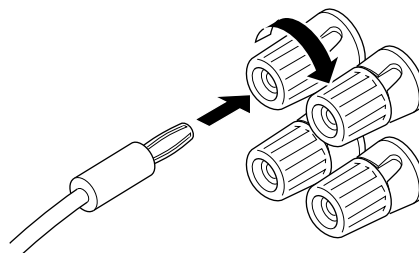

CONNECTING TO LINE OUTPUT (PIN JACK) TERMINALS OF THE AMPLIFIER

- Leave the main speakers connected to the amplifier.

1 CONNECTING TO PRE OUT OR SUBWOOFER OUT TERMINAL(S)

- Amplifier line output terminals are generally labeled PRE OUT or SUBWOOFER OUT.
 - * For PRE OUT terminal connection, the amplifier must possess at least two sets of PRE OUT terminals. With some amplifiers with only one set of PRE OUT terminals, connection can result in no sound from the main left and right speakers. In this case, select the method of connecting to the speaker terminals.
- To connect with a YAMAHA DSP amplifier, connect the LOW PASS (or SUBWOOFER etc.) terminal on the rear of the DSP amplifier to either the left (L) or right (R) INPUT 2 terminal.

To connect one unit only

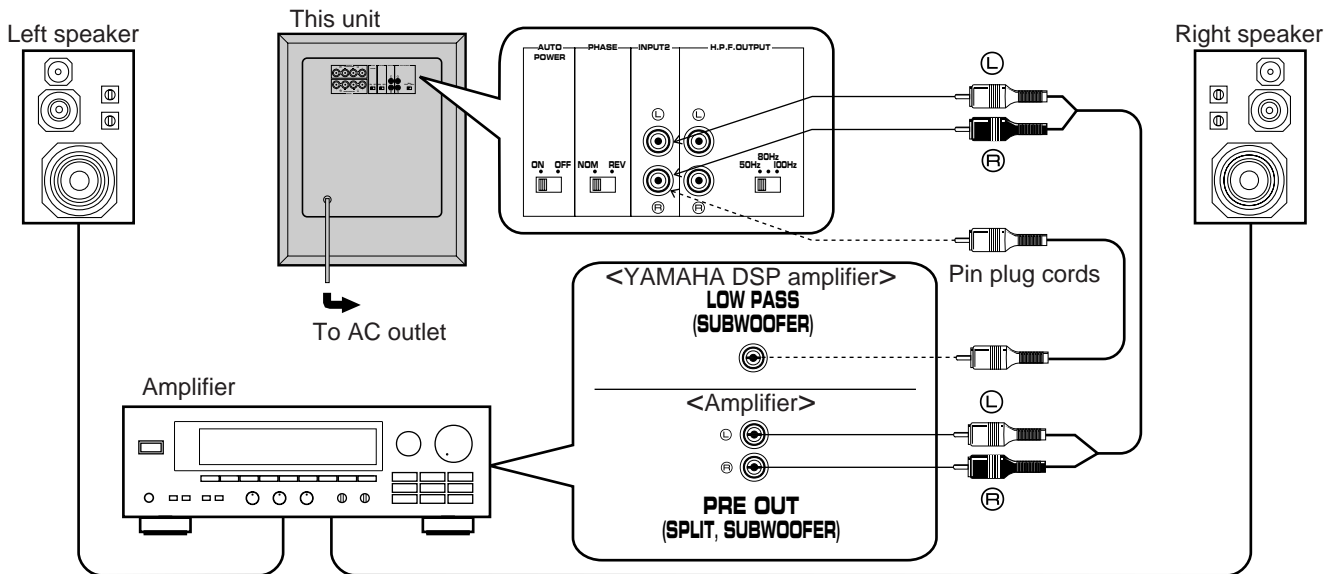

To connect two units

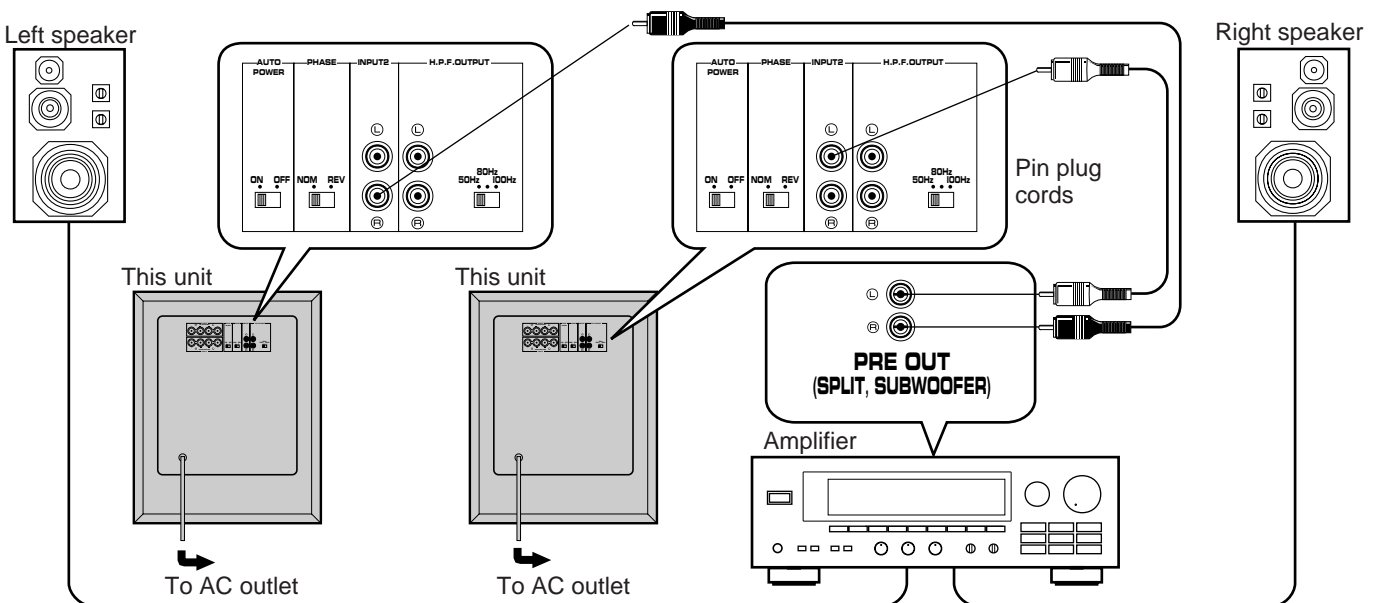

Notes

- When connected to line output terminals of the amplifier, other speakers should not be connected to the OUTPUT terminals on the rear panel of this unit. If connected, they will not produce sound.
- When connecting to a monaural line output terminal of the amplifier, connect to either the left or right INPUT 2 terminal.

2 CONNECTING TO PRE OUT AND MAIN IN TERMINALS

The use of the H.P.F. OUTPUT terminals for connections with the amplifier will improve sound quality of your speaker system. The H.P.F. (High-Pass Filter) OUTPUT terminals of this unit cut off frequencies below the selected frequency point from the input signals, and output high frequencies only. By connecting this terminal with the MAIN IN terminals of the amplifier, the main speakers reproduce high frequencies only.

This will make the whole sound quality clear by preventing sound muddying between the main speakers and this unit.

* This connection can be made if your amplifier has PRE OUT and MAIN IN terminals or you are using separate amplifiers (pre-amplifier and main amplifier).

To connect one unit only

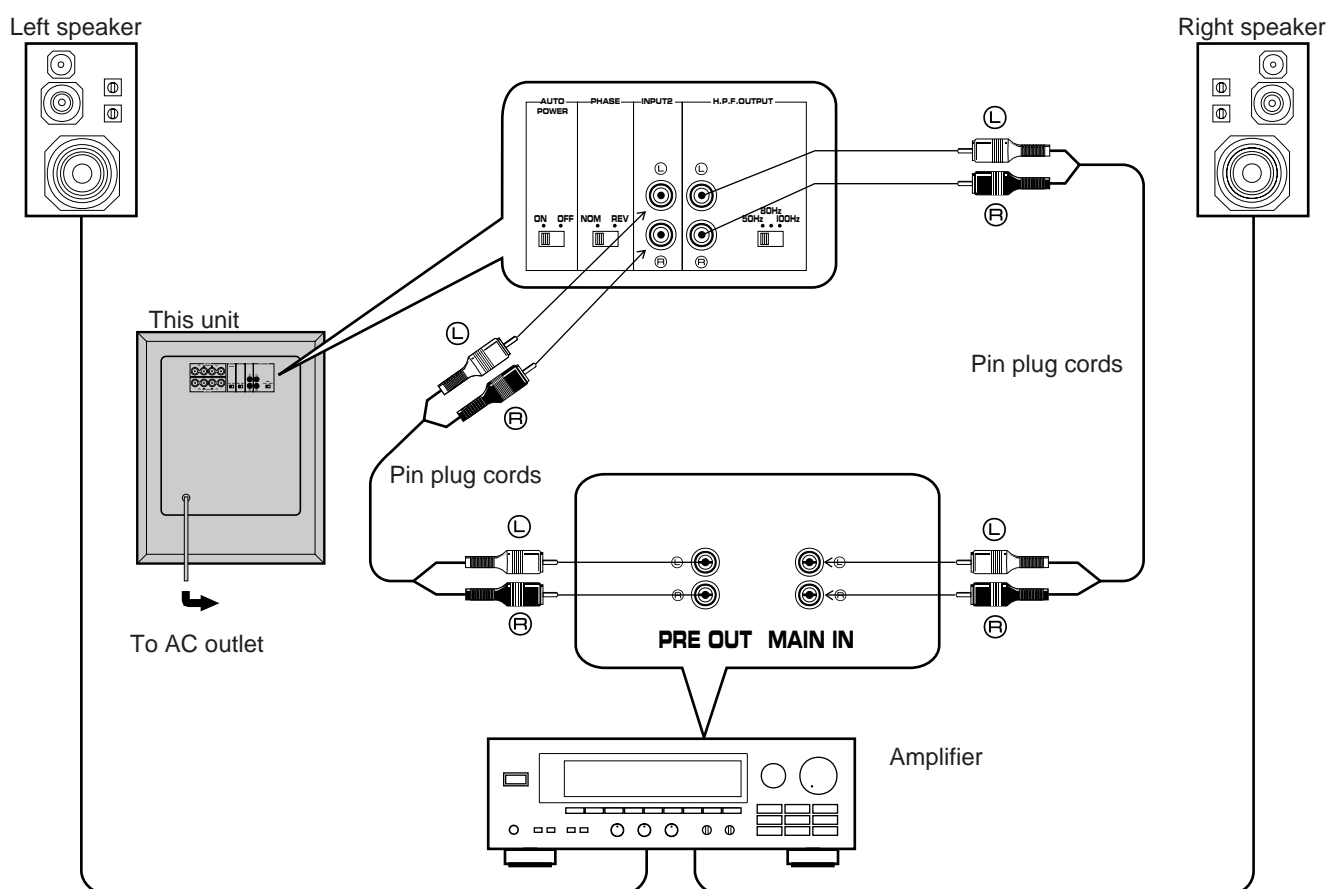

To connect two units

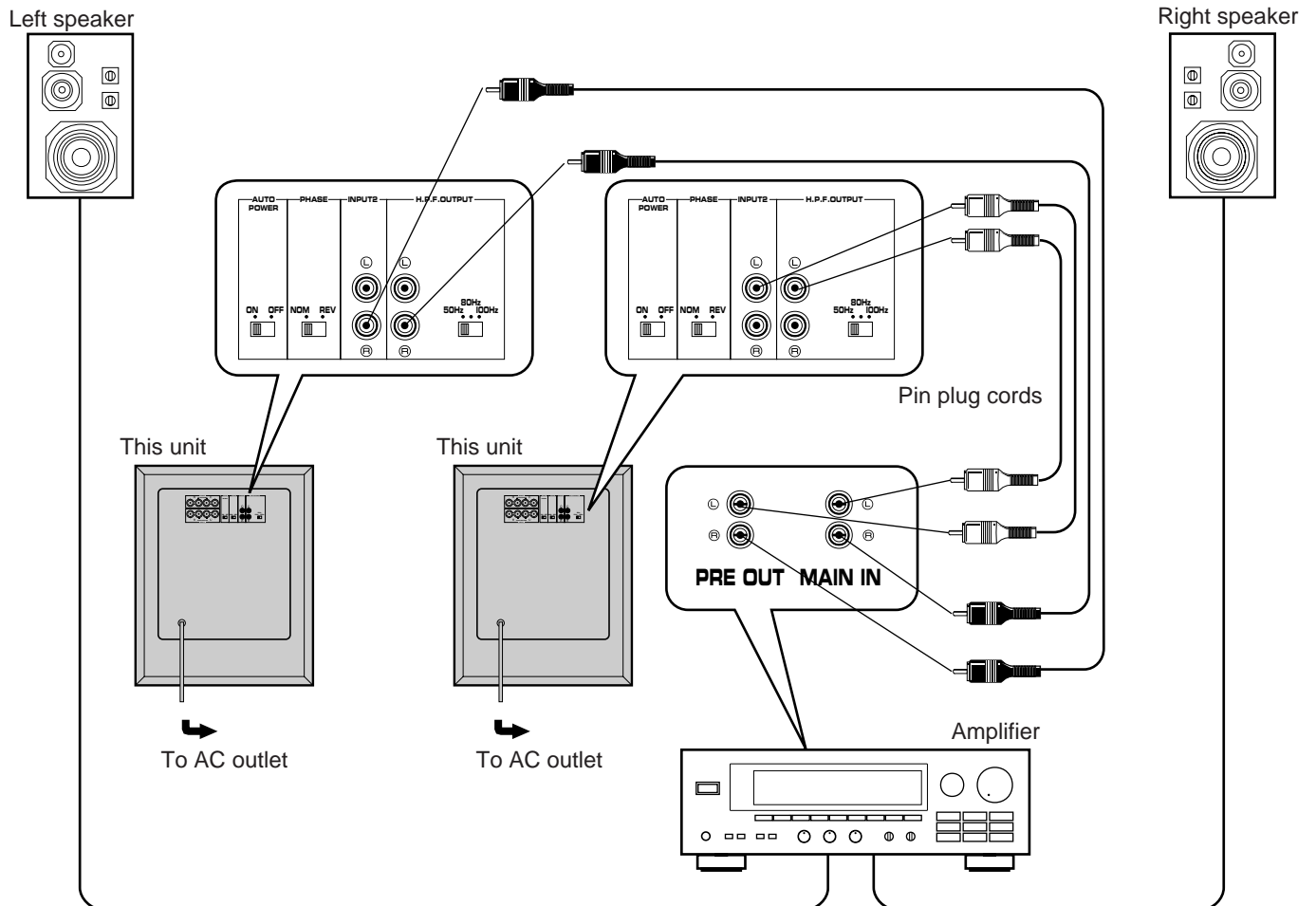

Switching the H.P.F. OUTPUT switch

After the connection is made, select the desired frequency point (50 Hz, 80 Hz or 100 Hz) with the **H.P.F. OUTPUT** switch.

Only frequencies higher than the selected frequency are output from the **H.P.F. OUTPUT** terminals.

Normally, it is recommended to select the frequency point nearer to the main speakers' minimum reproduceable frequency.

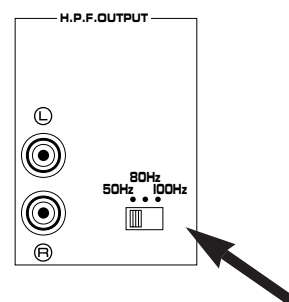

CONTROLS AND THEIR FUNCTIONS

Side panel

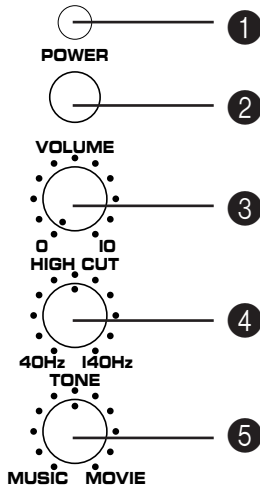

Rear panel

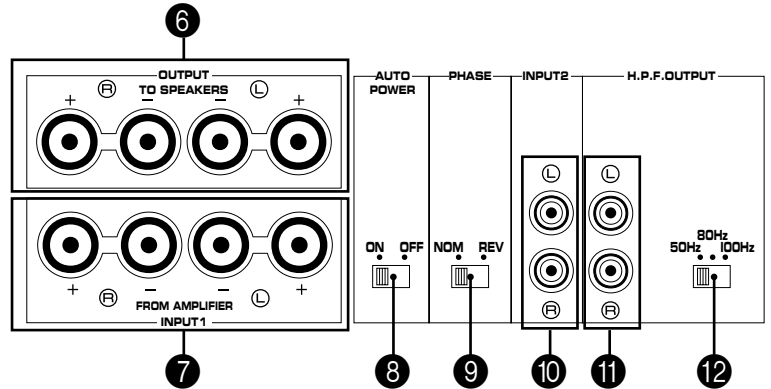

- 1 POWER indicator**
Lights in green when the **POWER** switch is turned ON, and goes off when turned OFF.
* Standby mode
If the **AUTO POWER ON/OFF** switch on the rear panel is set to ON, this indicator lights in red when no signal is input to this unit.

- 2 POWER switch**
Turns the power of this unit ON and OFF whenever pressed. When this switch is turned ON, the **POWER** indicator over the **POWER** switch lights up.

- 3 VOLUME control**
Adjusts the volume level.

- 4 HIGH CUT control**
Adjusts the high frequency cut off point. Frequencies higher than the frequency selected by this control are all cut off (and not output).
* One graduation of this control represents 10 Hz.

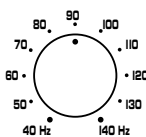

- 5 TONE control**
Used to increase or decrease the low frequency response. Turn this clockwise (toward the MOVIE position) to increase the low frequency response. Turn this counterclockwise (toward the MUSIC position) to decrease the low frequency response.

FREQUENCY CHARACTERISTICS

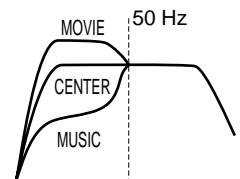
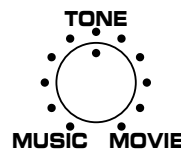

- 6 OUTPUT (TO SPEAKERS) terminals**
Can be used for connections with the main speakers. These terminals send signals output from the amplifier to the main speakers directly.
- 7 INPUT1 (FROM AMPLIFIER) terminals**
Used to connect this unit with the speaker terminals of the amplifier.

8 **AUTO POWER ON/OFF** switch

By setting this switch to the ON position, this unit's automatic power ON/OFF function operates as described below. If you do not need this function, set to the OFF position.

* Make sure to change the setting of this switch only when the power of this unit is off.

Automatic power ON/OFF function

When you play a source, the power to this unit turns on automatically by sensing audio signals input to this unit. The power turns off automatically if the source being played is stopped or the input signal is cut off for several minutes.

* This function will operate responding to a certain level of input signal. Increase the output level on the input source if the automatic power ON function will not operate, or decrease the level if the automatic power OFF function will not operate.

* There may be a case that the power turns on unexpectedly by sensing noise from other appliances. If it occurs, set the **AUTO POWER ON/OFF** switch to the OFF position.

This function is available only when the power of this unit is on (by setting the POWER switch (2) to "on").

9 **PHASE** switch

Normally this switch is to be set to the normal (NOM) position. However, according to your speaker systems or the listening condition, there may be a case when better sound quality is obtained by setting this switch to the reverse (REV) position. Select the better position by monitoring the sound.

10 **INPUT2** terminals

Used to input line level signals from the amplifier.

11 **H.P.F. OUTPUT** terminals

These terminals cut off frequencies below the frequency point selected by the H.P.F. OUTPUT switch from the input signals and output higher frequencies only.

12 **H.P.F. OUTPUT** switch

Use this switch only when the H.P.F. OUTPUT terminals are used for connecting with the amplifier. (See page 8 for details)

ADJUSTING VOLUME

Side panel

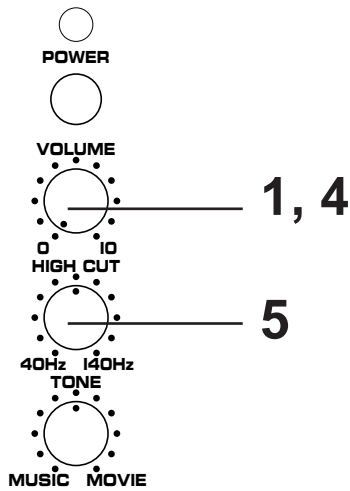

Rear panel

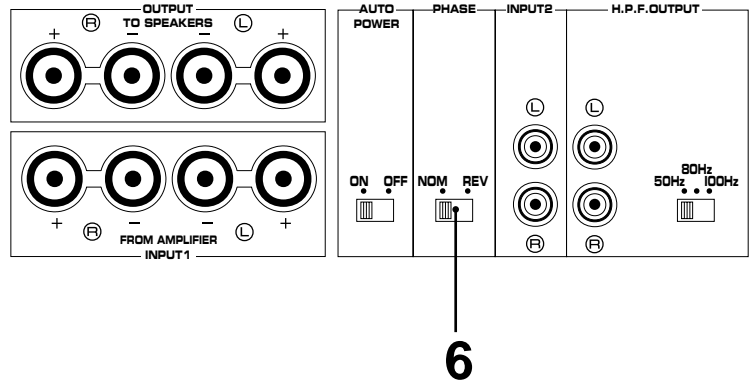

- 1** Set the **VOLUME** control to minimum.
- 2** Turn on the power supply to all the components.
- 3** Play any source and adjust the amplifier's volume control to the desired listening level.
- 4** Turn up the **VOLUME** control gradually to adjust the volume balance between this unit and the main speakers.
- 5** Adjust the **HIGH CUT** control to the position where the desired response can be obtained.
- 6** Set the **PHASE** switch to the position (NOM or REV) where the optimum bass effect can be obtained.

Notes

- Once the volume balance between this unit and the main speakers is adjusted, you can adjust the volume of your whole sound system by using only the amplifier's volume control.
- For adjusting the **VOLUME** control, the **HIGH CUT** control and the **PHASE** switch, refer to "FREQUENCY CHARACTERISTICS" on the next page.

For effective adjustment of the HIGH CUT control

First set this control at about the main speakers' rated minimum reproduceable frequency. Then turn up the **VOLUME** control gradually and set it at a level where you can obtain a little more bass effect than when this unit is not used. On the basis of this setting, if desired, adjust the **VOLUME** control and the **HIGH CUT** control again.

* The main speakers' minimum reproduceable frequency can be looked up in the speakers' catalog or owner's manual.

FREQUENCY CHARACTERISTICS

Adjustment of the **VOLUME** control, the **HIGH CUT** control and the **PHASE** switch should be changed according to the main speakers, listening condition, source, etc.

Following figures show the optimum adjustment of each control and the frequency characteristics when this unit is combined with a typical speaker system.

This unit's frequency characteristics

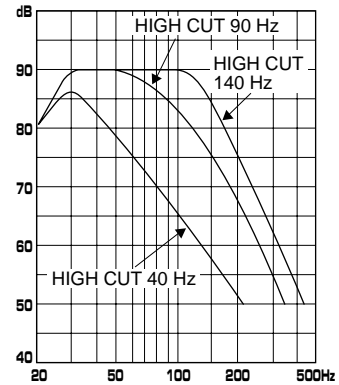

- When combined with a 4" or 5" acoustic suspension, 2 way system

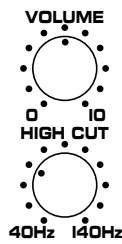

PHASE—Set to the reverse (REV) position.

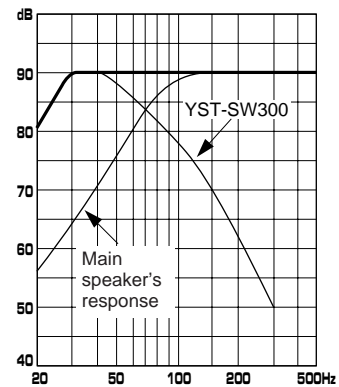

- When combined with an 6" or 8" acoustic suspension, 2 way system

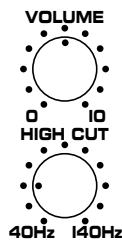

PHASE—Set to the reverse (REV) position.

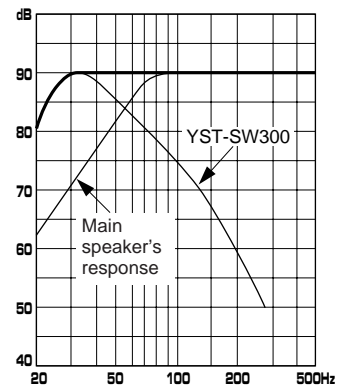

ACTIVE SERVO TECHNOLOGY

The theory of Active Servo Technology is based upon two major factors, the Helmholtz resonator and negative-impedance drive. Active Servo Processing speakers reproduce the bass frequencies through an "air woofer", which is a port or opening in the speaker's cabinet. This opening is used instead of, and performs the functions of, a woofer in a conventionally designed speaker system. Thus, signals of low amplitude within the cabinet can, according to the Helmholtz resonance theory, be output from this opening as waves of great amplitude if the design is such that the size of the opening and the volume of the cabinet are in the correct proportion to satisfy a certain ratio.

In order to accomplish this, moreover, the amplitudes within the cabinet must be both precise and of sufficient power because these amplitudes must overcome the "load" presented by the air that exists within the cabinet.

Thus it is this problem that is resolved through the employment of a design in which the amplifier functions to supply special signals. If the electrical resistance of the voice coil could be reduced to zero, the movement of the speaker unit would become linear with respect to signal voltage, and, to accomplish this, a special negative-impedance output-drive amplifier for subtracting output impedance of the amplifier is used.

By employing negative-impedance drive circuits, the amplifier is able to generate precise, low-amplitude low-frequency waves with superior damping characteristics, and these waves are then radiated from the cabinet opening as high-amplitude signals. The system can, therefore, by employing the negative-impedance output drive amplifier and a speaker cabinet with the Helmholtz resonator, reproduce an extremely wide range of frequencies with amazing sound quality and less distortion.

The features described above, then, are combined to be the fundamental structure of the Active Servo Technology.

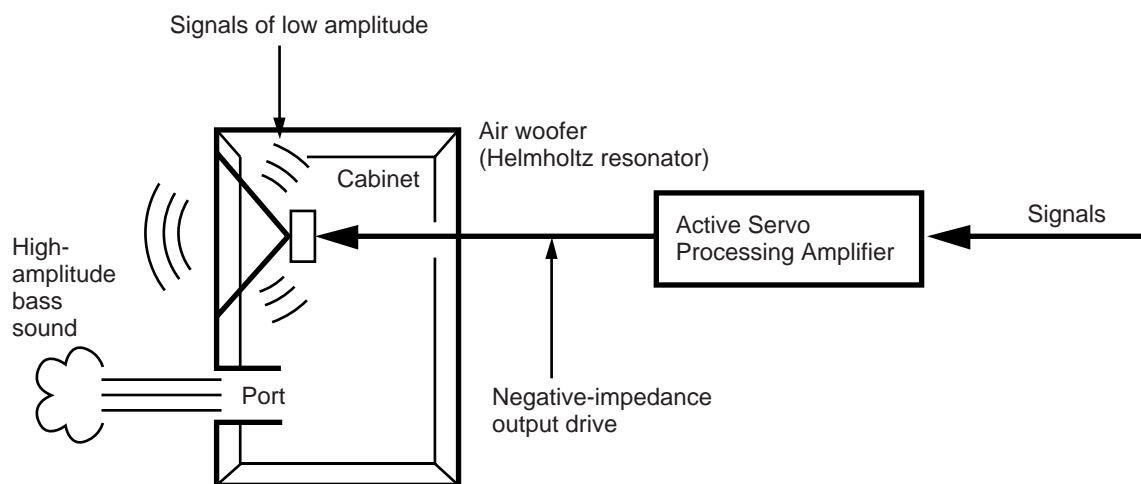

REMOVING THE FRONT GRILLE

The front grille is fastened to the enclosure at four points, and can be removed if desired. To remove the grille, first hold the bottom of the grille and unfasten the lower part of the grille by pulling it gently, and then hold both sides of the grille and slowly pull straight away from the speaker. To reattach, line up the four pegs on the inside surface of the grille with the four corresponding holes on the speaker and push gently.

Note

When the grille is removed, take care not to touch the speaker unit with your hands or to exert excessive force with tools.

TROUBLESHOOTING

If the unit fails to operate normally, check the following points to determine whether the fault can be corrected by the simple measures suggested. If it cannot be corrected, or if the fault is not listed in the SYMPTOM column, disconnect the power cord and contact your authorized YAMAHA dealer or service center for help.

SYMPTOM	CAUSE	REMEDY
Power is not supplied even though the POWER switch is ON.	The power plug is not securely connected.	Connect it securely.
No sound.	The VOLUME control is set to 0.	Turn the VOLUME control to right.
	Speaker cables are not connected securely.	Connect them securely.
Sound level is too low.	Speaker cables are connected incorrectly.	Connect them correctly, that is to say L (left) to L, R (right) to R, "+" to "+" and "-" to "-".
	Setting of the PHASE switch is not proper.	Set the switch to the other position.
	A source sound with few bass frequencies is played.	Play a source sound with bass frequencies. Set the HIGH CUT control to a higher position. (Turn the knob to right.)
	It is influenced by standing waves.	Re-position the subwoofer or break up the parallel surface by placing bookshelves etc. along the walls.
Automatic power ON function will not work.	The POWER switch is turned off.	Turn the POWER switch on.
	The level of input signal is too low.	Increase the level of input signal on the source.
Automatic power OFF function will work unexpectedly.	The level of input signal is too low.	Increase the level of input signal on the source.
Automatic power ON function will work unexpectedly.	An influence of noise generated from external digital equipment etc.	Move this unit farther away from such equipment and/or change the position of connected speaker cables. Otherwise, do not use the automatic power ON function of this unit.

SPECIFICATIONS

Type.....Active Servo Processing Subwoofer System
Speaker Unit30 cm (11-13/16") cone woofer
 magnetic-shield type
Amplifier Output.....185W/5 ohms
High-Cut Filter40 Hz–140 Hz (–24 dB/oct.)
Impedance
 INPUT 1.....4.7 k-ohms
 INPUT 2.....10 k-ohms
Frequency Response18 Hz–170 Hz (–10 dB)

Power SupplyAC 120V, 60 Hz
Power Consumption150W
Dimensions (W x H x D)400 mm x 500 mm x 434.5 mm
 (15-3/4" x 19-11/16" x 17-1/16")
Weight25.4 kg (55 lbs. 14 oz.)

* Please note that all specifications are subject to change without notice.

YAMAHA

YAMAHA ELECTRONICS CORPORATION, USA 6660 ORANGETHORPE AVE., BUENA PARK, CALIF. 90620, U.S.A.
YAMAHA CANADA MUSIC LTD. 135 MILNER AVE., SCARBOROUGH, ONTARIO M1S 3R1, CANADA
YAMAHA ELECTRONIK EUROPA G.m.b.H. SIEMENSSTR. 22-34, 25462 RELLINGEN BEI HAMBURG, F.R. OF GERMANY
YAMAHA ELECTRONIQUE FRANCE S.A. RUE AMBROISE CROIZAT BP70 CROISSY-BEAUBOURG 77312 MARNE-LA-VALLEE CEDEX02, FRANCE
YAMAHA ELECTRONICS (UK) LTD. YAMAHA HOUSE, 200 RICKMANSWORTH ROAD WATFORD, HERTS WD1 7JS, ENGLAND
YAMAHA SCANDINAVIA A.B. J A WETTERGRENS GATA 1, BOX 30053, 400 43 VÄSTRA FRÖLUNDA, SWEDEN
YAMAHA MUSIC AUSTRALIA PTY, LTD. 17-33 MARKET ST., SOUTH MELBOURNE, 3205 VIC., AUSTRALIA

YAMAHA CORPORATION
VV96060 Printed in Malaysia